

G9SP Series

Safety Controller

Instructions Reference Manual

OMRON

© **OMRON, 2010**

All rights reserved. No part of this publication may be reproduced, stored in a retrieval system, or transmitted, in any form, or by any means, mechanical, electronic, photocopying, recording, or otherwise, without the prior written permission of OMRON.

No patent liability is assumed with respect to the use of the information contained herein. Moreover, because OMRON is constantly striving to improve its high-quality products, the information contained in this manual is subject to change without notice. Every precaution has been taken in the preparation of this manual. Nevertheless, OMRON assumes no responsibility for errors or omissions. Neither is any liability assumed for damages resulting from the use of the information contained in this publication.

G9SP-series Safety Controller:

G9SP-N□□□

Instructions Reference Manual

Revised June 2014

Introduction

Thank you for purchasing a G9SP-series Safety Controller. This manual contains information required to use the G9SP-series Controller. Please thoroughly read and understand this manual before you use the G9SP-series Controller.

Intended Audience

This manual is intended for the following personnel, who must also have knowledge of electrical systems (an electrical engineer or the equivalent).

- Personnel in charge of installing FA systems.
- Personnel in charge of designing FA systems.
- Personnel in charge of managing FA systems and facilities.
- Personnel in charge of qualifications and authority in all phases, including system design, installation, operation, maintenance, and disposal.

Manual Configuration

Information on the operation of G9SP-series Safety Controllers is provided in the following manuals. Refer to the specific manual depending on the information that is required.

Manual name	Contents	Cat. No.
G9SP-series Safety Controller Instructions Reference Manual (this manual)	This manual describes the safety programming methods, provides the specifications, and describes the functions and operating methods of the G9SP-series Controller.	Z923
G9SP-series Safety Controller Operation Manual	This manual provides detailed specifications and describes functions and application methods for the G9SP-series Controller in detail.	Z922
G9SP-series Safety Controller Host Connection Manual	This manual provides sample ladder programming and describes how to connect to a Standard PLC from another manufacturer using the communications functionality of the G9SP-series Controller's Option Board. The procedure for connecting to a Standard PLC from another manufacturer is described in the G9SP Operation Manual.	Z924

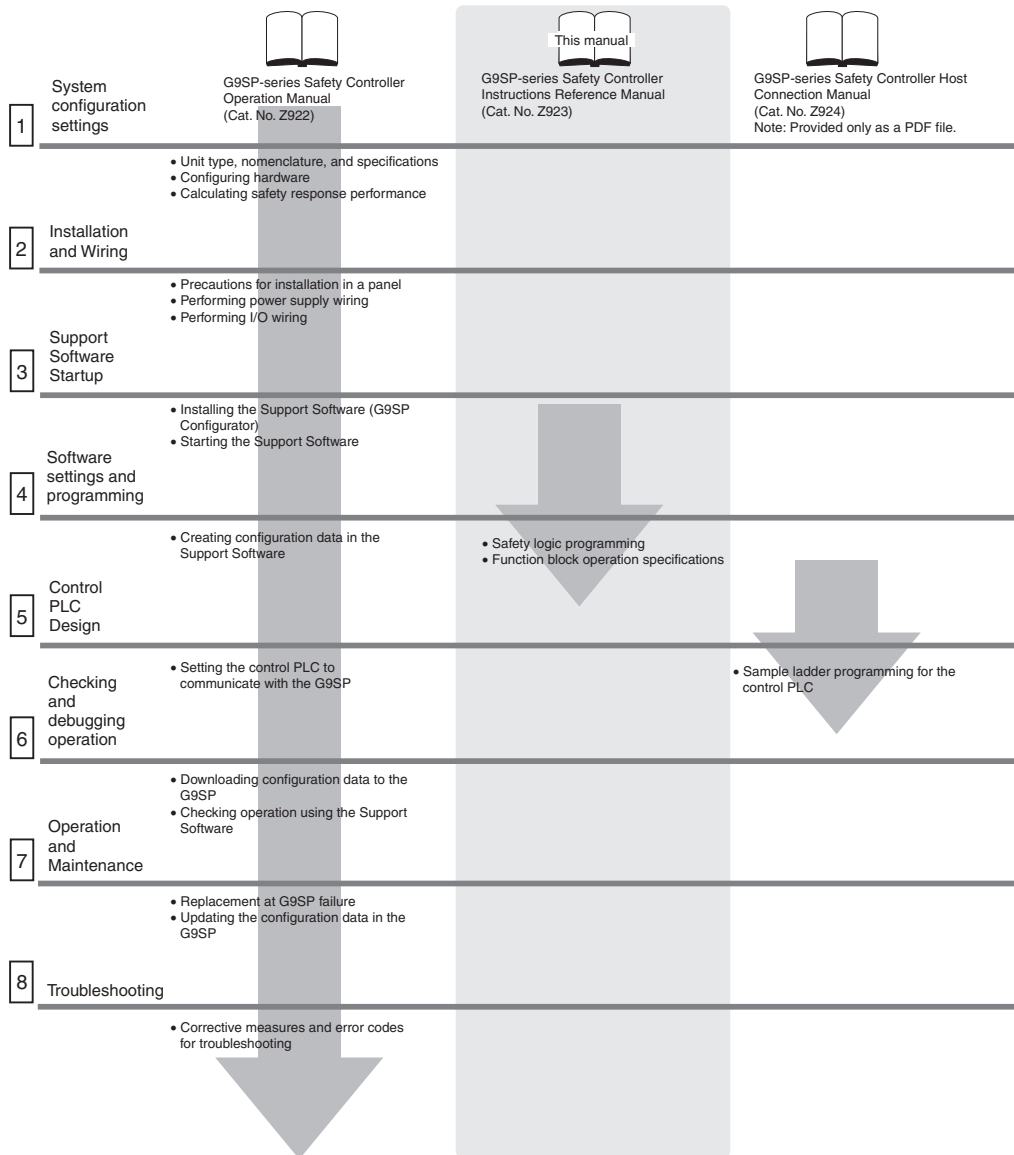

Sections in this Manual

1 Function Block Overview

2 Function Blocks

3 Descriptions of Function Blocks

TABLE OF CONTENTS

Introduction	vii
Manual Configuration	viii
Sections in this Manual	ix
Safety Precautions	xv
Glossary	xviii

SECTION 1

Function Block Overview	1
1-1 Outline	2
1-2 Function Block Editing	5

SECTION 2

Function Blocks	7
2-1 Function Blocks	8

SECTION 3

Descriptions of Function Blocks	11
3-1 Using this Section	12
3-2 Specifications for All Function Blocks	12
3-3 Logic Function Blocks	19
3-4 Timer/Counter Function Blocks	34
3-5 Safety Device Function Blocks	42
3-6 Reset and Restart Function Blocks	76
3-7 Connector Function Blocks	79

Index	83
--------------------	-----------

Revision History	85
-------------------------------	-----------

TABLE OF CONTENTS

Terms and Conditions Agreement

Warranty, Limitations of Liability

Warranties

● Exclusive Warranty

Omron's exclusive warranty is that the Products will be free from defects in materials and workmanship for a period of twelve months from the date of sale by Omron (or such other period expressed in writing by Omron). Omron disclaims all other warranties, express or implied.

● Limitations

OMRON MAKES NO WARRANTY OR REPRESENTATION, EXPRESS OR IMPLIED, ABOUT NON-INFRINGEMENT, MERCHANTABILITY OR FITNESS FOR A PARTICULAR PURPOSE OF THE PRODUCTS. BUYER ACKNOWLEDGES THAT IT ALONE HAS DETERMINED THAT THE PRODUCTS WILL SUITABLY MEET THE REQUIREMENTS OF THEIR INTENDED USE.

Omron further disclaims all warranties and responsibility of any type for claims or expenses based on infringement by the Products or otherwise of any intellectual property right.

● Buyer Remedy

Omron's sole obligation hereunder shall be, at Omron's election, to (i) replace (in the form originally shipped with Buyer responsible for labor charges for removal or replacement thereof) the non-complying Product, (ii) repair the non-complying Product, or (iii) repay or credit Buyer an amount equal to the purchase price of the non-complying Product; provided that in no event shall Omron be responsible for warranty, repair, indemnity or any other claims or expenses regarding the Products unless Omron's analysis confirms that the Products were properly handled, stored, installed and maintained and not subject to contamination, abuse, misuse or inappropriate modification. Return of any Products by Buyer must be approved in writing by Omron before shipment. Omron Companies shall not be liable for the suitability or unsuitability or the results from the use of Products in combination with any electrical or electronic components, circuits, system assemblies or any other materials or substances or environments. Any advice, recommendations or information given orally or in writing, are not to be construed as an amendment or addition to the above warranty.

See <http://www.omron.com/global/> or contact your Omron representative for published information.

Limitation on Liability; Etc

OMRON COMPANIES SHALL NOT BE LIABLE FOR SPECIAL, INDIRECT, INCIDENTAL, OR CONSEQUENTIAL DAMAGES, LOSS OF PROFITS OR PRODUCTION OR COMMERCIAL LOSS IN ANY WAY CONNECTED WITH THE PRODUCTS, WHETHER SUCH CLAIM IS BASED IN CONTRACT, WARRANTY, NEGLIGENCE OR STRICT LIABILITY.

Further, in no event shall liability of Omron Companies exceed the individual price of the Product on which liability is asserted.

Application Considerations

Suitability of Use

Omron Companies shall not be responsible for conformity with any standards, codes or regulations which apply to the combination of the Product in the Buyer's application or use of the Product. At Buyer's request, Omron will provide applicable third party certification documents identifying ratings and limitations of use which apply to the Product. This information by itself is not sufficient for a complete determination of the suitability of the Product in combination with the end product, machine, system, or other application or use. Buyer shall be solely responsible for determining appropriateness of the particular Product with respect to Buyer's application, product or system. Buyer shall take application responsibility in all cases.

NEVER USE THE PRODUCT FOR AN APPLICATION INVOLVING SERIOUS RISK TO LIFE OR PROPERTY WITHOUT ENSURING THAT THE SYSTEM AS A WHOLE HAS BEEN DESIGNED TO ADDRESS THE RISKS, AND THAT THE OMRON PRODUCT(S) IS PROPERLY RATED AND INSTALLED FOR THE INTENDED USE WITHIN THE OVERALL EQUIPMENT OR SYSTEM.

Programmable Products

Omron Companies shall not be responsible for the user's programming of a programmable Product, or any consequence thereof.

Disclaimers

Performance Data

Data presented in Omron Company websites, catalogs and other materials is provided as a guide for the user in determining suitability and does not constitute a warranty. It may represent the result of Omron's test conditions, and the user must correlate it to actual application requirements. Actual performance is subject to the Omron's Warranty and Limitations of Liability.

Change in Specifications

Product specifications and accessories may be changed at any time based on improvements and other reasons. It is our practice to change part numbers when published ratings or features are changed, or when significant construction changes are made. However, some specifications of the Product may be changed without any notice. When in doubt, special part numbers may be assigned to fix or establish key specifications for your application. Please consult with your Omron's representative at any time to confirm actual specifications of purchased Product.

Errors and Omissions

Information presented by Omron Companies has been checked and is believed to be accurate; however, no responsibility is assumed for clerical, typographical or proofreading errors or omissions.

Safety Precautions

Definition of Precautionary Information

The following notation is used in this manual to provide precautions required to ensure safe usage of a G9SP-series Controller. The safety precautions that are provided are extremely important to safety. Always read and heed the information provided in all safety precautions.

The keywords and their definitions are as given below.

 WARNING	Indicates a potentially hazardous situation which, if not avoided, will result in minor or moderate injury, or may result in serious injury or death. Additionally there may be significant property damage.
--	--

 Caution	Indicates a potentially hazardous situation which, if not avoided, may result in minor or moderate injury or in property damage.
--	--



Precautions for Safe Use

Indicates precautions on what to do and what not to do to ensure using the product safely.



Precautions for Correct Use

Indicates precautions on what to do and what not to do to ensure proper operation and performance.

Symbols



The circle and slash symbol indicates operations that you must not do. The specific operation is shown in the circle and explained in text.



The filled circle symbol indicates operations that you must do. The specific operation is shown in the circle and explained in text. This example shows a general precaution for something that you must do.

WARNING

This is the *Instructions Reference Manual* for the G9SP-series Safety Controllers.

Obey the following warnings during system construction to ensure that safety-related components are configured to enable the system functions to sufficiently operate.

● Risk Assessment

The proper use of the safety devices described in this manual as they relate to installation conditions and mechanical performance and functions is a prerequisite for its use.

When selecting or using the safety devices, risk assessment must be performed during the development stage of the equipment or facilities to identify potential danger factors in equipment or facilities in which the safety devices are to be applied. Suitable safety devices must be selected under the guidance of a sufficient risk assessment system. An insufficient risk assessment system may result in the selection of unsuitable safety devices.

- Typical related international standards: ISO 14121, Safety of Machinery -- Principles of Risk Assessment

● Safety Measures

When using this safety device to build systems containing safety-related components for equipment or facilities, the system must be designed with the full understanding of and conformance to international standards, such as those listed below, and/or standards in related industries.

- Typical related international standards: ISO/DIS 12100, Safety of Machinery -- Basic Concepts and General Principles for Design

IEC 61508, Safety Standard for Safety Instrumented Systems (Functional Safety of Electrical/Electronic/Programmable Electronic Safety-related Systems)

● Role of Safety Devices

The safety devices are provided with safety functions and mechanisms as stipulated in relevant standards, but suitable designs must be used to enable these functions and mechanisms to operate properly inside system constructions containing safety-related components. Build systems that enable these functions and mechanisms to perform properly, based on a full understanding of their operation.

- Typical related international standards: ISO 14119, Safety of machinery -- Interlocking devices associated with guards -- Principles for design and selection

● Installation of Safety Devices

The construction and installation of systems with safety-related components for equipment or facilities must be performed by technicians who have received suitable training.

- Typical related international standards: ISO/DIS 12100, Safety of Machinery -- Basic Concepts and General Principles for Design

IEC 61508, Safety Standard for Safety Instrumented Systems (Functional Safety of Electrical/Electronic/Programmable Electronic Safety-related Systems)

● Compliance with Laws and Regulations

This safety device conforms to the relevant regulations and standards, but make sure that it is used in compliance with local regulations and standards for the equipment or facilities in which it is applied.

- Typical related international standards: IEC 60204, Safety of Machinery -- Electrical Equipment of Machines

● Observing Precautions for Use

When putting the selected safety device to actual use, heed the specifications and precautions in this manual and those in the instruction manual that comes with the product. Using a product in a manner that deviates from these specifications and precautions will lead to unexpected failures in equipment or devices, and to damage that results from such failures, due to insufficient operating functions in safety-related components.

● Moving or Transferring Devices or Equipment

When moving or transferring devices or equipment, be sure to include this manual to ensure that the person to whom the device or equipment is being moved or transferred will be able to operate it properly.

- Typical related international standards: ISO/DIS 12100, Safety of Machinery -- Basic Concepts and General Principles for Design

IEC 61508, Safety Standard for Safety Instrumented Systems (Functional Safety of Electrical/Electronic/Programmable Electronic Safety-related Systems)

WARNING

Electric shock may occur. Do not touch the terminals while power is being supplied.	
Serious injury may possibly occur due to loss of required safety functions. Do not use the G9SP-series Controller's Test Outputs or Standard Outputs as Safety Outputs.	
Serious injury may possibly occur due to loss of required safety functions. Do not use the G9SP-series Controller's network data as Safety Data.	
Serious injury may possibly occur due to loss of required safety functions. Do not use indicators on the G9SP-series Controller for safety operations.	
Serious injury may possibly occur due to breakdown of Safety Outputs or Test Outputs. Do not connect loads beyond the rated values to the Safety Outputs and Test Outputs.	
Serious injury may possibly occur due to loss of required safety functions. Wire the G9SP-series Controller properly so that the 24-VDC line does NOT touch the outputs accidentally or unintentionally.	
Serious injury may possibly occur due to loss of required safety functions. Ground the 0V line of the power supply for external output devices so that the devices do NOT turn ON when the Safety Output line or the Test Output line is grounded.	
Serious injury may possibly occur due to loss of required safety functions. Perform user testing and confirm that all of the G9SP-series Controller's configuration data and operation is correct before starting system operation.	
Serious injury may possibly occur due to loss of required safety functions. When replacing a G9SP-series Controller, confirm the model of the Controller is correct and configure the replacement Controller suitably and confirm that it operates correctly.	
Serious injury may possibly occur due to loss of required safety functions. Once the data has been restored from the Memory Cassette, check that the configuration data of the G9SP-series Controller is correct in that it operates properly and carry out the validation testing (User Testing).	
Outputs may operate, possibly resulting in serious injury. Take sufficient safety measures before force-setting or force-resetting variables in the program.	
Serious injury may possibly occur due to loss of required safety functions. Use devices and parts related to safety functions according to legal regulations in the applicable country. Use certified items compliant with safety standards corresponding to the intended application.	

Glossary

The following terms are used in this manual to describe the function blocks of the G9SP-series Safety Controllers.

Terminology

Term	Definition
Safety	Describes a device, function, data, or other element for which special safety measures have been implemented for use in Safety Controls.
Standard	Describes a device, function, data, or other element that is used in Standard Controls. Used to differentiate from devices, functions, data, or other elements for which special safety measures have been implemented for use in Safety Controls.
Safety Controller	A highly reliable controller that is used in Safety Controls.
Standard PLC	A programmable controller (PLC) that is used for general controls. Used to differentiate from a PLC used for Safety Controls.
Expansion I/O Unit	The name of the CP1W-20EDT(-1) and CP1W-32ET(-1). Some of the OMRON CP1-series Expansion I/O Units can be used in a G9SP-series Controller. Expansion I/O Units are connected to a G9SP-series Controller to increase the number of Standard I/O points.
Option Board	The name of the CP1W-CIF01 and CP1W-CIF41. Some of the OMRON CP1-series Option Boards can be used in a G9SP-series Controller. An Option Board can be mounted in a G9SP-series Controller to communicate with a Standard PLC.
Memory Cassette	The name of the CP1W-ME05M. This OMRON CP1-series Memory Cassette can be used in a G9SP-series Controller. It is used to back up and restore configuration data in G9SP-series Controllers.
G9SP Configurator	The name of the WS02-G9SP-series. Support Software that is used to set up, program, and debug G9SP-series Controllers.
configuration data	Setup data that is used to operate a G9SP-series Controller. The configuration data is created with the G9SP Configurator and then downloaded from the computer to memory in the G9SP-series Controller. The configuration data contains the unit configuration settings, I/O terminal settings, system settings, and Safety Program.
backup	An operation used to write the configuration data stored in internal memory in the G9SP-series Controller to a Memory Cassette.
restore	An operation used to write the configuration data stored in a Memory Cassette to internal memory in the G9SP-series Controller.
Safety Input Device	An input device for which special safety measures have been implemented for use in Safety Controls. Safety Input Device is therefore a generic term for input devices such as emergency stop switches and safety door switches.
Safety Output Device	An output device for which special safety measures have been implemented for use in Safety Controls. Safety Output Device is therefore a generic term for output devices such as safety relays.
CP Series	A series of programmable controllers manufactured by OMRON.
NE1A Series	A series of Safety Network Controllers manufactured by OMRON. NE1A-series Controllers are high-end controllers in comparison to the G9SP-series Controllers.
dual channels	Two channels that are used for redundancy with Safety Inputs or Safety Outputs. If the two channels must have the same value, they are called equivalent dual channels. If they must have the opposite values, they are called complementary dual channels.
discrepancy	The state in which the status of two dual channels do not agree, resulting in a discrepancy error.

Acronyms

Acronym	Meaning
PFD	Probability of Failure on Demand.
PFH	Probability of Failure per Hour.
MC	Memory Cassette.
Si	Safety Input. An input from a Safety Input terminal. This term is used to differentiate from a Standard Input (IN).
So	Safety Output. An output from a Safety Output terminal. This term is used to differentiate from a Standard Output (OUT).
To	Test Output. An output from a Test Output terminal used to diagnose a Safety Input terminal by outputting a test pulse.

SECTION 1

Function Block Overview

This section provides an overview of the G9SP function blocks.

1-1	Outline.....	2
1-1-1	Function Block Basics.....	2
1-1-2	I/O Tags.....	2
1-2	Function Block Editing.....	5
1-2-1	Parameters.....	5
1-2-2	Setting the Number of I/O Points and Output Point Settings.....	5
1-2-3	Comments.....	6

1-1 Outline

Logic programming for G9SP-series Controllers is performed using function blocks. Various safety applications can be created by using the function blocks described in this manual for programming that complies with safety standards.

1-1-1 Function Block Basics

Function blocks are created using input tags, which indicate data input sources, and output tags, which indicate data output destinations. The I/O tags are connected with connection lines.

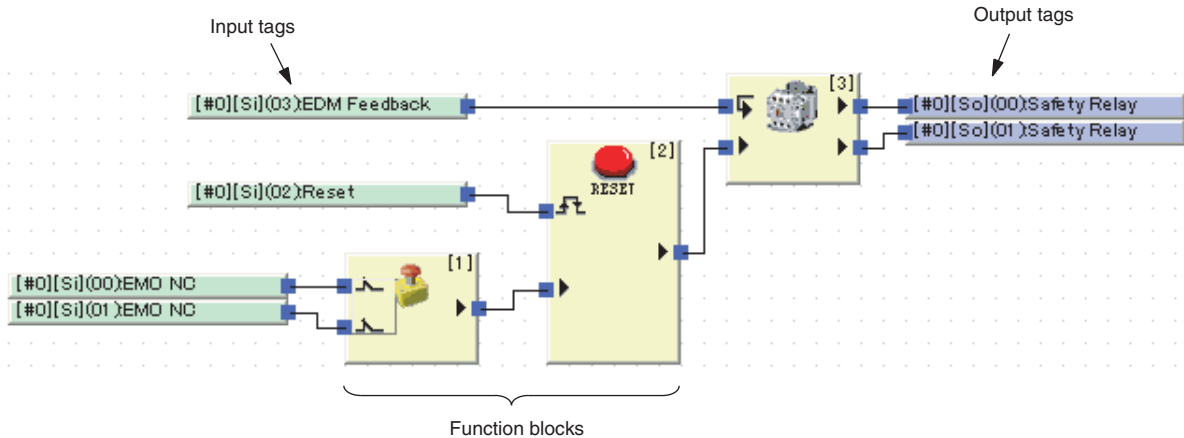

1-1-2 I/O Tags

Input Tags

The following data can be used by using input tags.

- S **Safety Input Terminal Values**
 The values of the G9SP-series Controller's built-in safety input terminals can be used. The values that are used, however, are not the terminal values themselves, but the values after safety input evaluation, such as dual-channel evaluations or ON/OFF delay judgments.
- Standard Input Terminal Values**
 The standard input terminal values of an Expansion I/O Unit can be used.
- Status**
 Status flags can be used to indicate the conditions of the G9SP-series Controller and whether an error has occurred.
 The following status as can be used.

Status name	Meaning
Unit Normal Operating Flag	0: Error occurred or program stopped. 1: Normal status (no error) and program being executed.
Output Power Supply Error Flag	0: Output power supply voltage normal. 1: Output power supply voltage error or power supply OFF.
Safety I/O Terminal Error Flag	0: No error in safety I/O terminals. 1: Error in safety I/O terminals.
Function Block Error Flag	0: No error in any function block. 1: Error in a function block.

- Communications Reception Data
The G9SP-series Controller can use data received from the Option Board.
-  Special Flags
The following flags can be used.

Flag name	Meaning
Always ON	Always ON (value: 1).
Always OFF	Always OFF (value: 0).
First Scan	ON (value: 1) only for the first scan after startup. Subsequently turns OFF (value: 0).

Output Tags

Output tags reflect the following status.

-  Safety Output Terminal Values
The output values can be specified for the G9SP-series Controller's built-in safety output terminals. The values that are specified, however, are not the terminal values themselves, but the values before performing safety output evaluation.
- Standard Output Terminal Values
You can specify values for the G9SP-series Controller's built-in standard output terminals (G9SP-N10S only), the T3 test output terminal, and the standard output terminals of the Expansion I/O Unit.
- Communications Send Data
G9SP-series Controller can specify data to send to the Option Board.

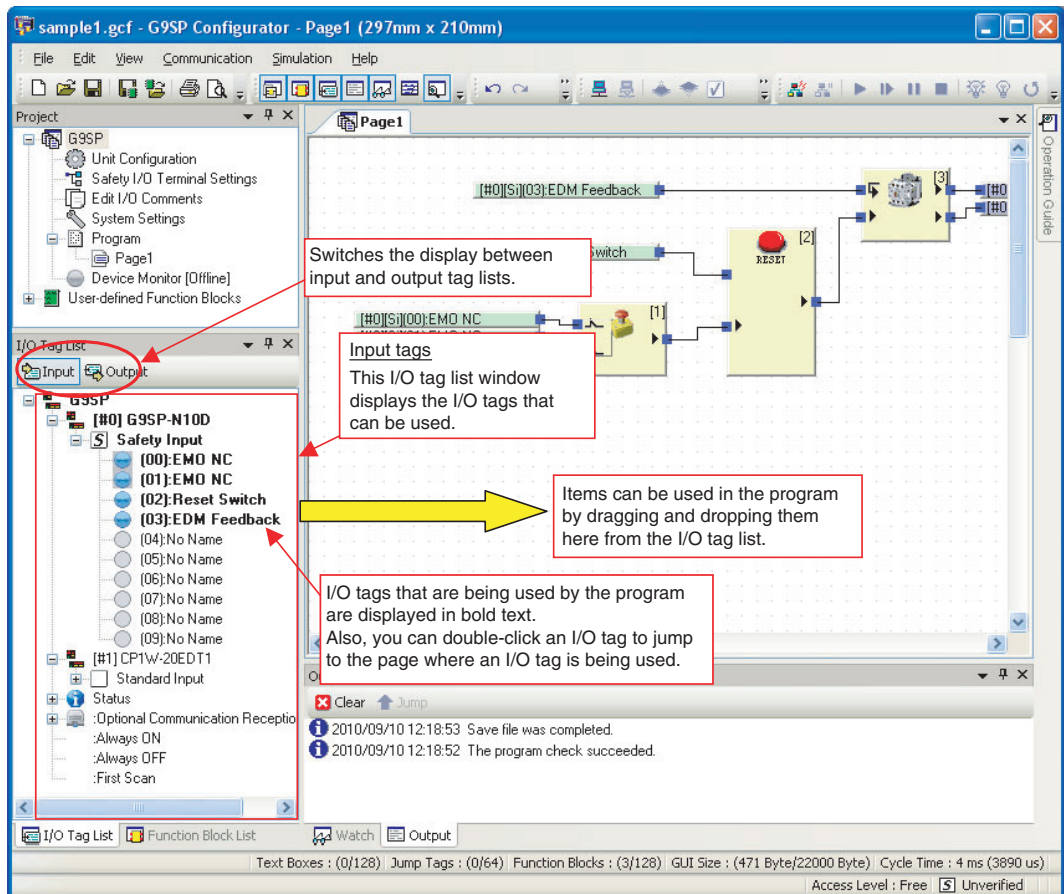



Precautions for Safe Use

Special measures have been implemented for data that is indicated by the  safety mark so that this data can be used in safety controls. Do not use any data without the safety mark in safety controls.

WARNING

Always sufficiently verify that the safety-related signals used in programming meet applicable standards and regulations. It is assumed that safety signals will be used for inputs to function blocks.



Serious injury may possibly occur due to loss of required safety functions. When configuring a system with safety-related functions using G9SP-series Controllers, you must verify that the control strategy and risk reduction techniques you are using adhere to local, regional, and national regulations. Consult these regulations and industry standards to determine the requirements that may apply to your application.



Additional Information

For the program capacity and other program specifications, refer to *6-2-3 Programming* in the *G9SP-series Safety Controller Operation Manual* (Cat. No. Z922).

1-2 Function Block Editing

Function blocks can be edited to set parameters, add optional I/O, and add comments for the application. The displayed tabs and contents of the settings depend on the function block.

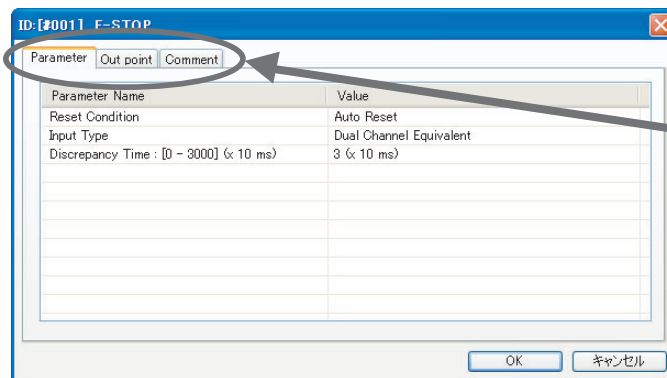

Tabs:

- Function block parameters
- Settings of the number of I/O points and output point settings.
- Comments

1-2-1 Parameters

The following parameters can be set for function blocks depending on the user application. The parameters that can be set will vary from function block to function block.

- Reset condition
- Input type
- Discrepancy time

Refer to *SECTION 3 Descriptions of Function Blocks* for information on the parameters for each function block.

1-2-2 Setting the Number of I/O Points and Output Point Settings

Setting the Number of I/O Points

The number of inputs and the number of outputs for a function block can be increased.

Output Point Settings

Optional outputs from function blocks can be enabled.

Fault Present

Fault Present is a diagnostic status bit that is enabled by selecting a check box located on the In/Out Setting or Output Point Tab Page. This bit turns ON when the function block detects incorrect logic or other errors in the input data. An OR of the Fault Present signal of each function block that is used in the program is stored in the Function Block Error Flag in the Error Status of the I/O tag.

Example: Safety Gate Monitoring Function Block

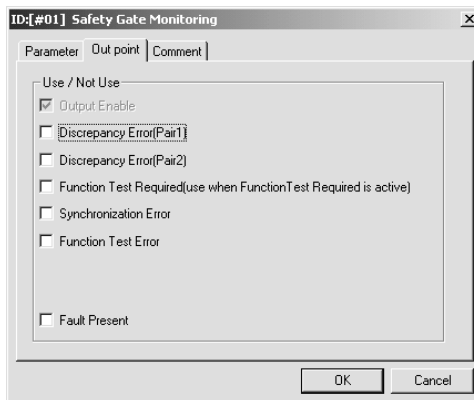

Out Point Tab Page in the Safety Gate Monitoring Function Block Editing Dialog

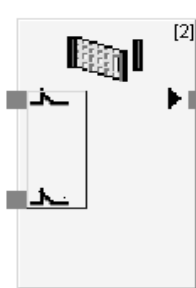

Safety Gate Monitoring Function Block with Default Settings



Safety Gate Monitoring Function Block with Maximum Inputs and Outputs Enabled

1-2-3 Comments

Comments can be added to function blocks (up to 12 single-byte alphanumeric characters or 4 single-byte kana characters).

The comments are displayed in the Logic Editor (programming window) and configuration reports.

SECTION 2

Function Blocks











This section provides tables of the G9SP function blocks.

2-1	Function Blocks	8
2-1-1	Logic Functions	8
2-1-2	Timer/Counter Functions	9
2-1-3	Safety Device Function Blocks.....	9
2-1-4	Reset and Restart Function Blocks.....	10
2-1-5	Connector Function Blocks	10







2-1 Function Blocks

The G9SP-series Controllers support the following logic functions and function blocks.









2-1-1 Logic Functions





Name	Notation on Function List	Icon	Details	Support by NE1A-series Controllers	Page
NOT	NOT		Outputs the logical complement of the input condition.	All unit versions	19
AND	AND		Outputs the logical AND of the input conditions.	All unit versions	19
OR	OR		Outputs the logical OR of the input conditions.	All unit versions	22
NAND	NAND		Outputs the logical NAND of the input conditions.	Not supported.	24
NOR	NOR		Outputs the logical NOR of the input conditions.	Not supported.	26
Exclusive OR	EXOR		Outputs the exclusive OR of the input conditions.	All unit versions	28
Exclusive NOR	EXNOR		Outputs the exclusive NOR of the input conditions.	All unit versions	28
RS-FF (Reset Set Flip-Flop)	RS-FF		When the input signal turns ON, RS-FF holds the ON status in the function block and continuously connects to the output.	Unit version 1.0 or later	29
Comparator	Comparator		Compares the input signals to the set value and turns ON the output if they match.	Unit version 1.0 or later	30
Comparator 2	Comparator 2		Compares the input signals to the set value and outputs the comparison result.	Not supported.	32

2-1-2 Timer/Counter Functions



Name	Notation on Function List	Icon	Details	Support by NE1A-series Controllers	Page
Off-Delay Timer	Off-Delay Timer		Operates an OFF-delay timer.	All unit versions	34
On-Delay Timer	On-Delay Timer		Operates an ON-delay timer	All unit versions	34
Pulse Generator	Pulse Generator		Cyclically outputs ON/OFF pulses on the Output Enable while the input signal is ON.	NE1A-series Controllers with unit version 1.0 or later	35
Counter	Counter		Counts the number of input signals and turns ON the output when the count reaches the specified number.	NE1A-series Controllers with unit version 1.0 or later	36
Up-Down Counter	Up-Down Counter		Increments the counter on the rising edge of an up count input and decrements the counter on the rising edge of a down count input.	Not supported.	38
Serial-Parallel Converter	Serial-Parallel Converter		Counts the number of input signals and outputs the count value.	Not supported.	38

2-1-3 Safety Device Function Blocks



Name	Notation on Function List	Icon	Details	Support by NE1A-series Controllers	Page
External Device Monitoring	EDM		Evaluates the input signal and external device status and sends a safety output to the external device. This function block is used to detect fused contacts or external wiring problems (disconnected lines) for safety relays, contactors, and other safety devices.	All unit versions	43
Enable Switch	Enable Switch		Monitors the status of an enable switch device.	NE1A-series Controllers with unit version 1.0 or later	44
Emergency Stop Switch Monitoring	E-STOP		Monitors the status of an emergency stop switch.	All unit versions	47
Light Curtain Monitoring	Light Curtain Monitoring		Monitors the input signal from a Safety Light Curtain.	All unit versions	48
Muting	Muting		Temporarily disables the input signals for a Light Curtain when the muting signal is detected.	NE1A-series Controllers with unit version 1.0 or later.	50
Safety Gate Monitoring	Safety Gate Monitoring		Temporarily disables the input signal for a Safety Gate (e.g., safety door switch or safety limit switch) when the muting signal is detected. This function block can be used to set function tests for Safety Category 2.	All unit versions	65
Two Hand Controller	Two Hand Controller		Monitors the status of a Two-hand Switch.	All unit versions	70
User Mode Switch Monitoring	User Mode Switch		Monitors the operating mode switch for a user system or device.	All unit versions	72

Name	Notation on Function List	Icon	Details	Support by NE1A-series Controllers	Page
Redundant Input	Generic Two-input Monitoring		Monitors for discrepancies in two input signals.	Not supported.	74
Single Beam Safety Sensor	Single Beam Safety Sensor Monitoring		Monitors the input signal of an OMRON E3ZS/E3FS Single-beam Safety Sensor.	Not supported.	74
Non-Contact Door Switch Monitoring	Non-Contact Door Switch		The Non-Contact Door Switch function block monitors the status of an OMRON D40A or D40Z Non-contact Door Switch.	Not supported.	74
Safety Mat Monitoring	Safety Mat		Monitors the status of an OMRON UM Safety Mat.	Not supported.	75

2-1-4 Reset and Restart Function Blocks

Name	Notation on Function List	Icon	Details	Support by NE1A-series Controllers	Page
Reset	Reset		Outputs ON if the reset signal is correctly input while the input condition is ON. This function block can be used to prevent equipment from starting automatically.	All unit versions	76
Restart	Restart		Performs the same operation as a Reset function block. The icon is different. Refer to 3-6-1 Reset for a description of functions and setting parameters.	All unit versions	78

2-1-5 Connector Function Blocks

Name	Notation on Function List	Icon	Details	Support by NE1A-series Controllers	Page
Multi Connector	Multi Connector		Outputs the status of the input signals.	NE1A-series Controllers with unit version 1.0 or later	79
Routing	Routing		Distributes an input signal to multiple signals.	All unit versions	80

SECTION 3

Descriptions of Function Blocks

This section describes specifications that are common to all of the function blocks and describes how to use function blocks.

3-1	Using this Section	12
3-2	Specifications for All Function Blocks	12
3-2-1	Operation at Startup	13
3-2-2	Precautions for Timer and Time Set Values	13
3-2-3	Function Block Parameter Settings	13
3-3	Logic Function Blocks	19
3-3-1	NOT	19
3-3-2	AND	19
3-3-3	OR	22
3-3-4	NAND	24
3-3-5	NOR	26
3-3-6	Exclusive OR (EXOR)	28
3-3-7	Exclusive NOR (EXNOR)	28
3-3-8	Reset Set Flip-Flop (RS-FF)	29
3-3-9	Comparator	30
3-3-10	Comparator2	32
3-4	Timer/Counter Function Blocks	34
3-4-4	Counter	36
3-4-1	OFF-delay Timer	34
3-4-2	ON-delay Timer	34
3-4-3	Pulse Generator	35
3-4-5	Up-Down Counter	38
3-4-6	Serial-Parallel Converter	40
3-5	Safety Device Function Blocks	42
3-5-1	External Device Monitoring (EDM)	43
3-5-2	Enable Switch Monitoring (Enable Switch)	44
3-5-3	Emergency Stop Pushbutton Monitoring (E-Stop)	47
3-5-4	Light Curtain Monitoring	48
3-5-5	Muting	50
3-5-6	Safety Gate Monitoring	65
3-5-7	Two-hand Control	70
3-5-8	User Mode Switch	72
3-5-9	Redundant Input	74
3-5-10	Single Beam Safety Sensor Monitoring	74
3-5-11	Non-Contact Door Switch	74
3-5-12	Safety Mat	75
3-6	Reset and Restart Function Blocks	76
3-6-1	Reset	76
3-6-2	Restart	78
3-7	Connector Function Blocks	79
3-7-1	Multi Connector	79
3-7-2	Routing	80

3-1 Using this Section

The following items are described for each function block.

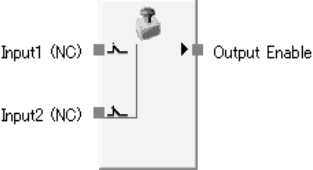
Item	Contents									
Instruction Name	The name of the function block is given. Example: Emergency Stop Switch Monitoring									
Overview	An overview of the function block functions is provided.									
Diagram	The Logic Editor symbol is shown. Example: 									
General Description	The functions of the function block are described in detail. Example: Emergency Stop Switch Monitoring When an input from the Emergency Stop Switch is activated, the Output Enable signal is turned ON. When an input is not activated or when an error is detected in the function block, the Output Enable signal is turned OFF.									
Parameter Settings	The parameters to be set for the function block are described. Example: <table border="1" data-bbox="491 919 1394 1178"> <thead> <tr> <th>Parameter</th> <th>Setting range</th> <th>Default</th> </tr> </thead> <tbody> <tr> <td>Input Type</td> <td> <ul style="list-style-type: none"> • Single Channel • Dual Channel Equivalent • Dual Channel Complementary </td> <td>Dual Channel Equivalent</td> </tr> <tr> <td>Discrepancy Time</td> <td> 0 to 30 s in units of 10 ms Discrepancy time checks are not performed when this parameter is set to 0. </td> <td>30 ms</td> </tr> </tbody> </table>	Parameter	Setting range	Default	Input Type	<ul style="list-style-type: none"> • Single Channel • Dual Channel Equivalent • Dual Channel Complementary 	Dual Channel Equivalent	Discrepancy Time	0 to 30 s in units of 10 ms Discrepancy time checks are not performed when this parameter is set to 0.	30 ms
Parameter	Setting range	Default								
Input Type	<ul style="list-style-type: none"> • Single Channel • Dual Channel Equivalent • Dual Channel Complementary 	Dual Channel Equivalent								
Discrepancy Time	0 to 30 s in units of 10 ms Discrepancy time checks are not performed when this parameter is set to 0.	30 ms								
Optional I/O Settings	The additional I/O signals that can be set are described.									
Truth Tables	The output signals corresponding to combinations of input signals are given.									
Error Handling and Error Resetting	Error status, operations when an error occur, and the recovery procedure are given.									
Timing Charts	I/O operations are shown in timing charts.									

3-2 Specifications for All Function Blocks

Function blocks can be edited according to the application by setting parameters and adding optional inputs, optional outputs, and comments. The tabs displayed and the settings depend on the function block. This section gives specifications that are the same for all function blocks.

3-2-1 Operation at Startup

When operation of the G9SP-series Controller is started, many function blocks will turn OFF all errors, restart all timers, and perform outputs according to the input status in the same manner as in the normal cycle. Some function blocks require processing only at startup of operation. For details, refer to the information on each function block

Operation at startup	Function blocks
Outputs performed according to the input status the same as in the normal cycle	OFF-Delay Timer ON-Delay Timer Pulse Generator Emergency Stop Switch Monitoring Light Curtain Monitoring User Mode Switch Monitoring External Device Monitoring Muting Generic Two-input Monitoring Single-beam Safety Sensor Monitoring Non-Contact Door Switch Safety Mat
Input conditions for counting up (The input must change from OFF to ON.)	Counter Up-down Counter Serial-parallel Converter
Input conditions for output (The status must change from inactive to active.)	Two-hand Controller Enable Switch Monitoring
Processing when function test is enabled (waiting for normal completion of open-close test for safety door)	Safety Gate Monitoring

3-2-2 Precautions for Timer and Time Set Values

A value equal to or greater than the cycle time of the G9SP-series Controller must be set for the time set values used in all function blocks, such as discrepancy time and OFF-delay time. Also, operation is performed with these time values rounded to the cycle time unit. Specifically, operation is performed in a period that is between the minimum cycle time multiple that exceeds the time set value and the minimum cycle time multiple that equals or exceeds time set value plus 10 ms.

For example, if the discrepancy time is set to 500 ms and the cycle time is 7 ms, operation will be performed at between 504 ms (i.e., $7 \text{ ms} \times 72$) and 511 ms (i.e., $7 \text{ ms} \times 73$).

3-2-3 Function Block Parameter Settings

This section describes the parameters that are used by many function blocks. The possible settings and setting ranges depend on the function block.

- Input type
- Discrepancy time

Input Type Settings

- Single Channel
- Dual Channel Equivalent
- Dual Channel Complementary

- Dual Channel Equivalent (2 Pairs)
- Dual Channel Complementary (2 Pairs)

The following truth tables outline the internal evaluations performed by the G9SP-series Controller for each type of input signal. In the tables, 0 indicates OFF and 1 indicates ON.

Setting: Single Channel

Input 1 (NC)	Output Enable
0	0
1	1

Setting: Dual Channel Equivalent

Input 1 (NC)	Input 2 (NC)	Output Enable
0	0	0
0	1	0
1	0	0
1	1	1

Setting: Dual Channel Complementary

Input 1 (NC)	Input 2 (NO)	Output Enable
0	0	0
0	1	0
1	0	1
1	1	0

Setting: Dual Channel Equivalent (2 Pairs)

Input 1 (NC)	Input 2 (NC)	Input 3 (NC)	Input 4 (NC)	Output Enable
0	0	0	0	0
0	0	0	1	0
0	0	1	0	0
0	0	1	1	0
0	1	0	0	0
0	1	0	1	0
0	1	1	0	0
0	1	1	1	0
1	0	0	0	0
1	0	0	1	0
1	0	1	0	0
1	0	1	1	0
1	1	0	0	0
1	1	0	1	0
1	1	1	0	0
1	1	1	1	0

Setting: Dual Channel Complementary (2 Pairs)

Input 1 (NC)	Input 2 (NO)	Input 3 (NC)	Input 4 (NO)	Output Enable
0	0	0	0	0
0	0	0	1	0
0	0	1	0	0
0	0	1	1	0
0	1	0	0	0
0	1	0	1	0
0	1	1	0	0
0	1	1	1	0
1	0	0	0	0
1	0	0	1	0
1	0	1	0	1
1	0	1	1	0
1	1	0	0	0
1	1	0	1	0
1	1	1	0	0
1	1	1	1	0

Discrepancy Time

If the function block input type is set to Dual Channel, the discrepancy time (i.e., the time between changes in the inputs) can be evaluated.

The time between when one of the dual-channel inputs changes until the other one changes is monitored. If the second dual-channel input does not change before the discrepancy time expires, an error will occur and the Output Enable output from the function block will not turn ON.

Dual channel mode	Input signals		Input signal status
	Input 1	Input 2	
Dual Channel Equivalent • Input 1: NC • Input 2: NC	0	0	Inactive
	0	1	Discrepancy
	1	0	Discrepancy
	1	1	Active
Dual Channel Complementary • Input 1: NC • Input 2: NO	0	0	Discrepancy
	0	1	Inactive
	1	0	Active
	1	1	Discrepancy

The dual channel modes can be used to detect faults in safety devices and safety device wiring monitored by the function block.

The discrepancy time monitoring time can be set to from 0 (disabled) to 30,000 ms in 10-ms increments. The discrepancy time setting is disabled if Single Channel Mode is set.

Parameters	Setting range	Default
Discrepancy time	0 to 30 s in units of 10 ms Discrepancy time checks are not performed when this parameter is set to 0.	30 ms

The discrepancy time is evaluated when the input signal changes.

Normal Operation Example for Dual Channel Equivalent Setting

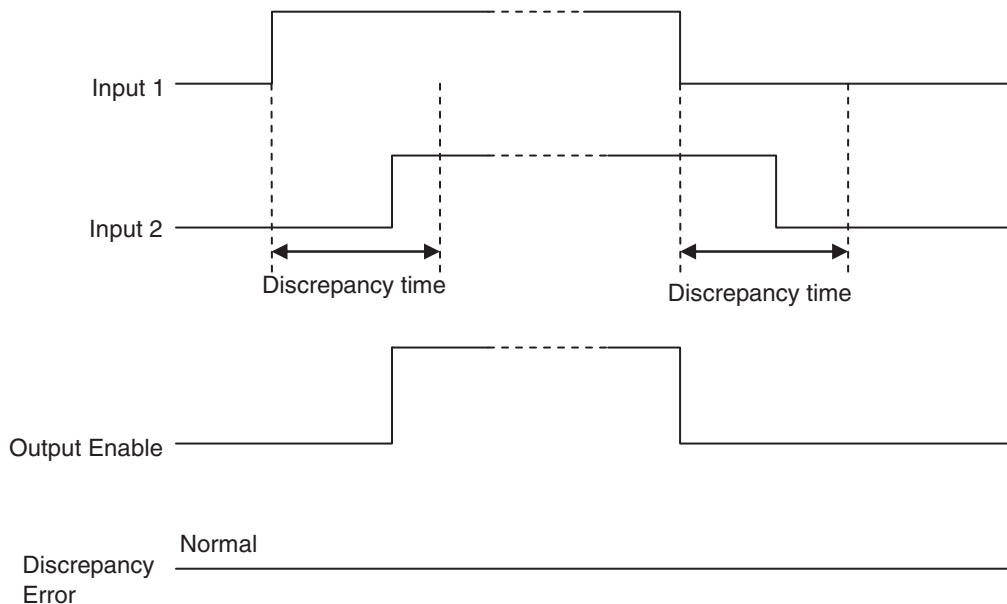

Discrepancy Error Operation Example for Dual Channel Equivalent Setting

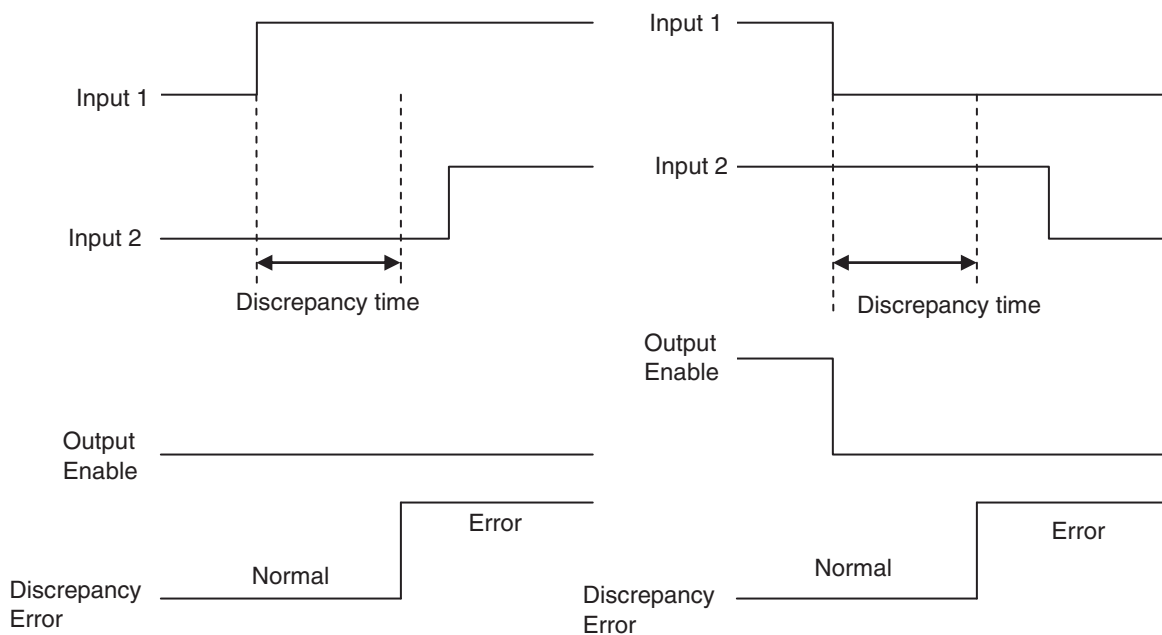

Timer Operation Conditions for Discrepancy Time

When operation is started, calculation of the discrepancy time will start regardless of whether a function test is required if the status of input 1 and input 2 are discrepant.

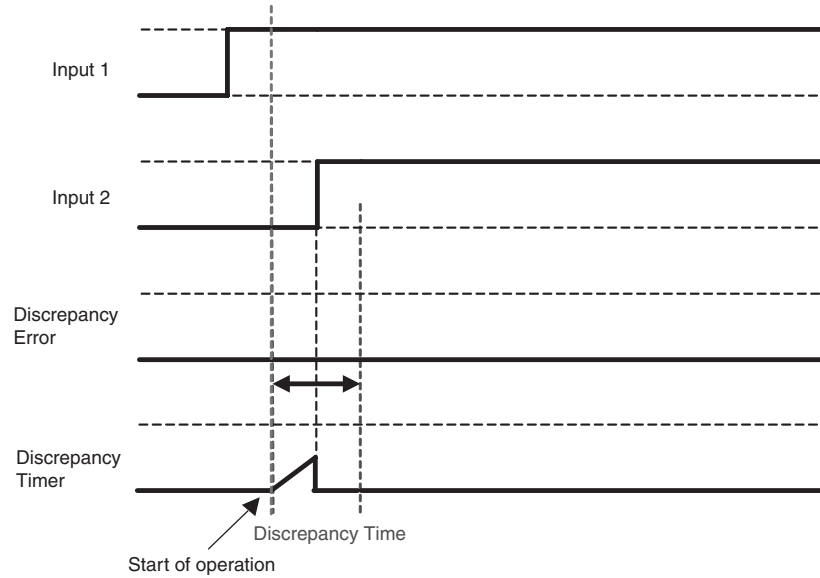

Calculation of the discrepancy time will continue while the input status are discrepant even if the input status changes.

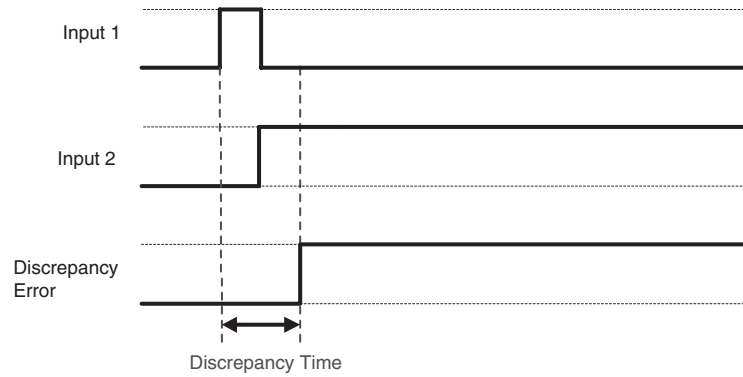

The discrepancy time will be reset when input 1 and input 2 are inactive, and calculation will start when the status of input 1 and input 2 become discrepant.

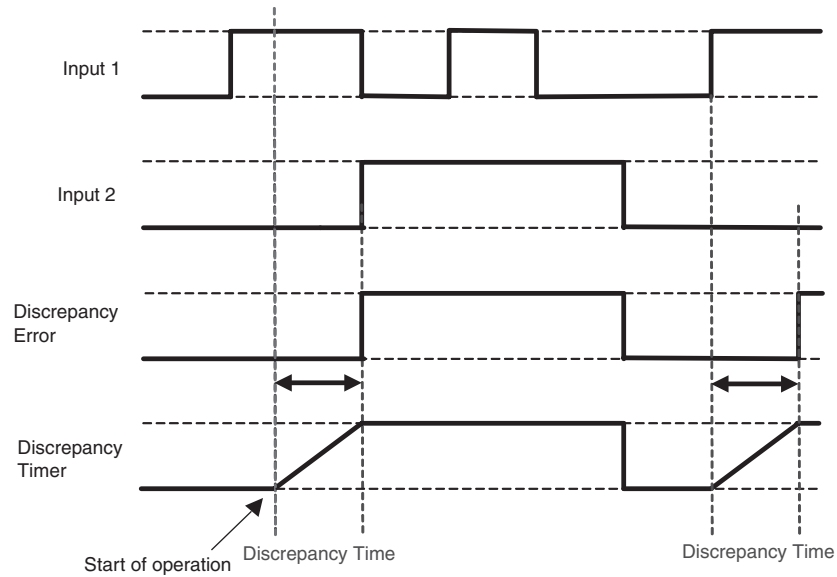

Operation at Discrepancy Error Detection

The following function block errors will be displayed if there is a discrepancy error.

- Output Enable turns OFF.
- Discrepancy Error turns ON.
- Fault Present turns ON.

Resetting Discrepancy Errors

All the following conditions are required to reset a discrepancy error.

Remove the cause of the error.

- Make the input active and then inactive again.
- Change the G9SP-series Controller's operating mode to IDLE Mode and then back to RUN Mode.

Priority for Discrepancy Errors and Normal Inputs

If a discrepancy error and normal input occur in the same cycle, the normal input will be given priority, and there will be no discrepancy error.

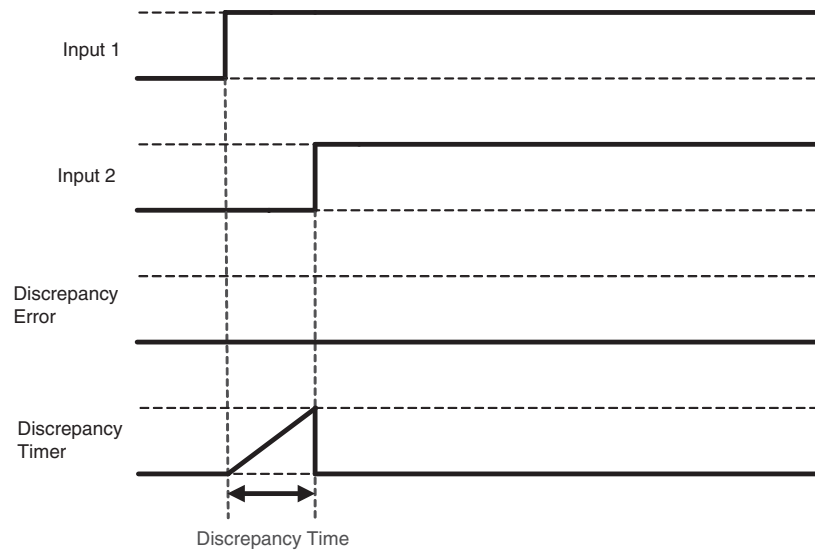

3-3 Logic Function Blocks

Section	Function Blocks		Support		Page	Compatible unit versions
	Notation in function list	Name	G9SP	NE1A		
3-3-1	NOT	NOT	○	○	19	
3-3-2	AND	AND	○	○	19	
3-3-3	OR	OR	○	○	22	
3-3-4	NAND	NAND	○	×	24	
3-3-5	NOR	NOR	○	×	26	
3-3-6	EXOR	Exclusive OR	○	○	28	
3-3-7	EXNOR	Exclusive NOR	○	○	28	
3-3-8	RS-FF	Reset Set Flip-flop	○	○	29	NE1A-series Controllers with unit version 1.0 or later
3-3-9	Comparator	Comparator	○	○	30	NE1A-series Controllers with unit version 1.0 or later
3-3-10	Comparator2	Comparator 2	○	×	32	

×: No, ○: Yes

3-3-1 NOT

Basic Function

The output will be the complement of the input.

Diagram



General Description

The output will be the complement of the input.

Truth Table

Truth Table for NOT Evaluation

Input 1	Output 1
0	1
1	0

0: OFF, 1: ON

3-3-2 AND

Basic Function

An AND of the input signals will be output.

Diagram

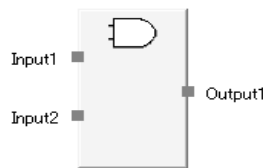

Default

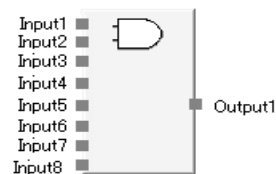

Maximum Number of Inputs

General Description

An AND of the input signals will be output.
Up to eight input signals can be evaluated.

Optional Input Settings

The number of inputs can be increased on the In/Out Setting Tab Page in the function block property dialog box.

Parameter	Setting range	Default setting
Number of inputs	1 to 8	2

Truth Tables**Truth Table for One-input AND Evaluation**

Input 1	Output 1
0	0
1	1

0: OFF, 1: ON

Truth Table for Two-input AND Evaluation

Input 1	Input 2	Output 1
0	x	0
x	0	0
1	1	1

0: OFF, 1: ON, x: Either ON or OFF

Truth Table for Three-input AND Evaluation

Input 1	Input 2	Input 3	Output 1
0	x	x	0
x	0	x	0
x	x	0	0
1	1	1	1

0: OFF, 1: ON, x: Either ON or OFF

Truth Table for Four-input AND Evaluation

Input 1	Input 2	Input 3	Input 4	Output 1
0	x	x	x	0
x	0	x	x	0
x	x	0	x	0
x	x	x	0	0
1	1	1	1	1

0: OFF, 1: ON, x: Either ON or OFF

Truth Table for Five-input AND Evaluation

Input 1	Input 2	Input 3	Input 4	Input 5	Output 1
0	x	x	x	x	0
x	0	x	x	x	0
x	x	0	x	x	0
x	x	x	0	x	0
x	x	x	x	0	0
1	1	1	1	1	1

0: OFF, 1: ON, x: Either ON or OFF

Truth Table for Six-input AND Evaluation

Input 1	Input 2	Input 3	Input 4	Input 5	Input 6	Output 1
0	x	x	x	x	x	0
x	0	x	x	x	x	0
x	x	0	x	x	x	0
x	x	x	0	x	x	0
x	x	x	x	0	x	0
x	x	x	x	x	0	0
1	1	1	1	1	1	1

0: OFF, 1: ON, x: Either ON or OFF

Truth Table for Seven-input AND Evaluation

Input 1	Input 2	Input 3	Input 4	Input 5	Input 6	Input 7	Output 1
0	x	x	x	x	x	x	0
x	0	x	x	x	x	x	0
x	x	0	x	x	x	x	0
x	x	x	0	x	x	x	0
x	x	x	x	0	x	x	0
x	x	x	x	x	0	x	0
x	x	x	x	x	x	0	0
1	1	1	1	1	1	1	1

0: OFF, 1: ON, x: Either ON or OFF

Truth Table for Eight-input AND Evaluation

Input 1	Input 2	Input 3	Input 4	Input 5	Input 6	Input 7	Input 8	Output 1
0	x	x	x	x	x	x	x	0
x	0	x	x	x	x	x	x	0
x	x	0	x	x	x	x	x	0
x	x	x	0	x	x	x	x	0
x	x	x	x	0	x	x	x	0
x	x	x	x	x	0	x	x	0
x	x	x	x	x	x	0	x	0
x	x	x	x	x	x	x	0	0
1	1	1	1	1	1	1	1	1

0: OFF, 1: ON, x: Either ON or OFF

3-3-3 OR

Basic Function

An OR of the input signals will be output.

Diagram

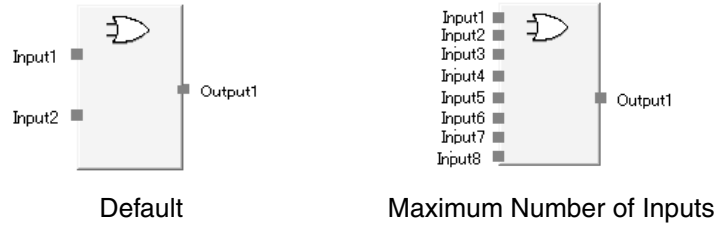

General Description

An OR of the input signals will be output.
Up to eight input signals can be evaluated.

Optional Input Setting

The number of inputs can be increased on In/Out Setting Tab Page in the function block property dialog box.

Parameter	Setting range	Default setting
Number of inputs	1 to 8	2

Truth Table

Truth Table for One-input OR Evaluation

Input 1	Output 1
0	0
1	1

0: OFF, 1: ON

Truth Table for Two-input OR Evaluation

Input 1	Input 2	Output 1
0	0	0
1	x	1
x	1	1

0: OFF, 1: ON, x: Either ON or OFF

Truth Table for Three-input OR Evaluation

Input 1	Input 2	Input 3	Output 1
0	0	0	0
1	x	x	1
x	1	x	1
x	x	1	1

0: OFF, 1: ON, x: Either ON or OFF

Truth Table for Four-input OR Evaluation

Input 1	Input 2	Input 3	Input 4	Output 1
0	0	0	0	0
1	x	x	x	1
x	1	x	x	1
x	x	1	x	1
x	x	x	1	1

0: OFF, 1: ON, x: Either ON or OFF

Truth Table for Five-input OR Evaluation

Input 1	Input 2	Input 3	Input 4	Input 5	Output 1
0	0	0	0	0	0
1	x	x	x	x	1
x	1	x	x	x	1
x	x	1	x	x	1
x	x	x	1	x	1
x	x	x	x	1	1

0: OFF, 1: ON, x: Either ON or OFF

Truth Table for Six-input OR Evaluation

Input 1	Input 2	Input 3	Input 4	Input 5	Input 6	Output 1
0	0	0	0	0	0	0
1	x	x	x	x	x	1
x	1	x	x	x	x	1
x	x	1	x	x	x	1
x	x	x	1	x	x	1
x	x	x	x	1	x	1
x	x	x	x	x	1	1

0: OFF, 1: ON, x: Either ON or OFF

Truth Table for Seven-input OR Evaluation

Input 1	Input 2	Input 3	Input 4	Input 5	Input 6	Input 7	Output 1
0	0	0	0	0	0	0	0
1	x	x	x	x	x	x	1
x	1	x	x	x	x	x	1
x	x	1	x	x	x	x	1
x	x	x	1	x	x	x	1
x	x	x	x	1	x	x	1
x	x	x	x	x	1	x	1
x	x	x	x	x	x	1	1

0: OFF, 1: ON, x: Either ON or OFF

Truth Table for Eight-input OR Evaluation

Input 1	Input 2	Input 3	Input 4	Input 5	Input 6	Input 7	Input 8	Output 1
0	0	0	0	0	0	0	0	0
1	x	x	x	x	x	x	x	1
x	1	x	x	x	x	x	x	1
x	x	1	x	x	x	x	x	1
x	x	x	1	x	x	x	x	1
x	x	x	x	1	x	x	x	1
x	x	x	x	x	1	x	x	1
x	x	x	x	x	x	1	x	1
x	x	x	x	x	x	x	1	1

0: OFF, 1: ON, x: Either ON or OFF

3-3-4 NAND

Basic Function

A logical NAND of the input signals is output.

Diagram

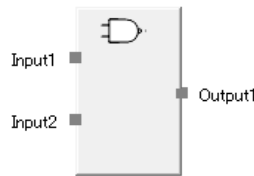

Default

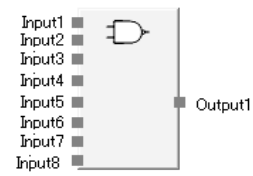

Maximum Number of Inputs

General Description

A logical NAND of the input signals is output.

Up to eight input signals can be evaluated.

Optional Input Setting

The number of inputs can be increased on In/Out Setting Tab Page in the function block property dialog box.

Parameter	Setting range	Default setting
Number of inputs	1 to 8	2

Truth Table

Truth Table for One-input NAND Evaluation

Input 1	Output 1
0	1
1	0

0: OFF, 1: ON

Truth Table for Two-input NAND Evaluation

Input 1	Input 2	Output 1
0	x	1
x	0	1
1	1	0

0: OFF, 1: ON, x: Either ON or OFF

Truth Table for Three-input NAND Evaluation

Input 1	Input 2	Input 3	Output 1
0	x	x	1
x	0	x	1
x	x	0	1
1	1	1	0

0: OFF, 1: ON, x: Either ON or OFF

Truth Table for Four-input NAND Evaluation

Input 1	Input 2	Input 3	Input 4	Output 1
0	x	x	x	1
x	0	x	x	1
x	x	0	x	1
x	x	x	0	1
1	1	1	1	0

0: OFF, 1: ON, x: Either ON or OFF

Truth Table for Five-input NAND Evaluation

Input 1	Input 2	Input 3	Input 4	Input 5	Output 1
0	x	x	x	x	1
x	0	x	x	x	1
x	x	0	x	x	1
x	x	x	0	x	1
x	x	x	x	0	1
1	1	1	1	1	0

0: OFF, 1: ON, x: Either ON or OFF

Truth Table for Six-input NAND Evaluation

Input 1	Input 2	Input 3	Input 4	Input 5	Input 6	Output 1
0	x	x	x	x	x	1
x	0	x	x	x	x	1
x	x	0	x	x	x	1
x	x	x	0	x	x	1
x	x	x	x	0	x	1
x	x	x	x	x	0	1
1	1	1	1	1	1	0

0: OFF, 1: ON, x: Either ON or OFF

Truth Table for Seven-input NAND Evaluation

Input 1	Input 2	Input 3	Input 4	Input 5	Input 6	Input 7	Output 1
0	x	x	x	x	x	x	1
x	0	x	x	x	x	x	1
x	x	0	x	x	x	x	1
x	x	x	0	x	x	x	1
x	x	x	x	0	x	x	1
x	x	x	x	x	0	x	1
x	x	x	x	x	x	0	1
1	1	1	1	1	1	1	0

0: OFF, 1: ON, x: Either ON or OFF

Truth Table for Eight-input NAND Evaluation

Input 1	Input 2	Input 3	Input 4	Input 5	Input 6	Input 7	Input 8	Output 1
0	x	x	x	x	x	x	x	1
x	0	x	x	x	x	x	x	1
x	x	0	x	x	x	x	x	1
x	x	x	0	x	x	x	x	1
x	x	x	x	0	x	x	x	1
x	x	x	x	x	0	x	x	1
x	x	x	x	x	x	0	x	1
x	x	x	x	x	x	x	0	1
1	1	1	1	1	1	1	1	0

0: OFF, 1: ON, x: Either ON or OFF

3-3-5 NOR

Basic Function

A logical NOR of the input signals is output.

Diagram

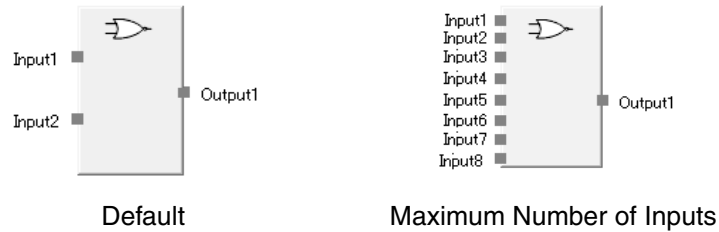

General Description

A logical NOR of the input signals is output.
Up to eight input signals can be evaluated.

Optional Input Setting

The number of inputs can be increased on In/Out Setting Tab Page in the function block property dialog box.

Parameter	Setting range	Default setting
Number of inputs	1 to 8	2

Truth Table

Truth Table for One-input NOR Evaluation

Input 1	Output 1
0	1
1	0

0: OFF, 1: ON

Truth Table for Two-input NOR Evaluation

Input 1	Input 2	Output 1
0	0	1
1	x	0
x	1	0

0: OFF, 1: ON, x: Either ON or OFF

Truth Table for Three-input NOR Evaluation

Input 1	Input 2	Input 3	Output 1
0	0	0	1
1	x	x	0
x	1	x	0
x	x	1	0

0: OFF, 1: ON, x: Either ON or OFF

Truth Table for Four-input NOR Evaluation

Input 1	Input 2	Input 3	Input 4	Output 1
0	0	0	0	1
1	x	x	x	0
x	1	x	x	0
x	x	1	x	0
x	x	x	1	0

0: OFF, 1: ON, x: Either ON or OFF

Truth Table for Five-input NOR Evaluation

Input 1	Input 2	Input 3	Input 4	Input 5	Output 1
0	0	0	0	0	1
1	x	x	x	x	0
x	1	x	x	x	0
x	x	1	x	x	0
x	x	x	1	x	0
x	x	x	x	1	0

0: OFF, 1: ON, x: Either ON or OFF

Truth Table for Six-input NOR Evaluation

Input 1	Input 2	Input 3	Input 4	Input 5	Input 6	Output 1
0	0	0	0	0	0	1
1	x	x	x	x	x	0
x	1	x	x	x	x	0
x	x	1	x	x	x	0
x	x	x	1	x	x	0
x	x	x	x	1	x	0
x	x	x	x	x	1	0

0: OFF, 1: ON, x: Either ON or OFF

Truth Table for Seven-input NOR Evaluation

Input 1	Input 2	Input 3	Input 4	Input 5	Input 6	Input 7	Output 1
0	0	0	0	0	0	0	1
1	x	x	x	x	x	x	0
x	1	x	x	x	x	x	0
x	x	1	x	x	x	x	0
x	x	x	1	x	x	x	0
x	x	x	x	1	x	x	0
x	x	x	x	x	1	0	0
x	x	x	x	x	x	1	0

0: OFF, 1: ON, x: Either ON or OFF

Truth Table for Eight-input NOR Evaluation

Input 1	Input 2	Input 3	Input 4	Input 5	Input 6	Input 7	Input 8	Output 1
0	0	0	0	0	0	0	0	1
1	x	x	x	x	x	x	x	0
x	1	x	x	x	x	x	x	0
x	x	1	x	x	x	x	x	0
x	x	x	1	x	x	x	x	0
x	x	x	x	1	x	x	x	0
x	x	x	x	x	1	x	x	0
x	x	x	x	x	x	1	x	0
x	x	x	x	x	x	x	1	0

0: OFF, 1: ON, x: Either ON or OFF

3-3-6 Exclusive OR (EXOR)

Basic Function

An exclusive OR of the input signals will be output.

Diagram



General Description

An exclusive OR of the input signals will be output.

Truth Table

Truth Table for Exclusive OR Evaluation

Input 1	Input 2	Output 1
0	0	0
0	1	1
1	0	1
1	1	0

0: OFF, 1: ON

3-3-7 Exclusive NOR (EXNOR)

Basic Function

An exclusive NOR of the input signals will be output.

Diagram



General Description

An exclusive NOR of the input signals will be output.

Truth Table

Truth Table for Exclusive NOR Evaluation

Input 1	Input 2	Output 1
0	0	1
0	1	0
1	0	0
1	1	1

0: OFF, 1: ON

3-3-8 Reset Set Flip-Flop (RS-FF)

Basic Function

When the input signal turns ON, RS-FF holds the ON status in the function block and continuously connects to the output.

Diagram

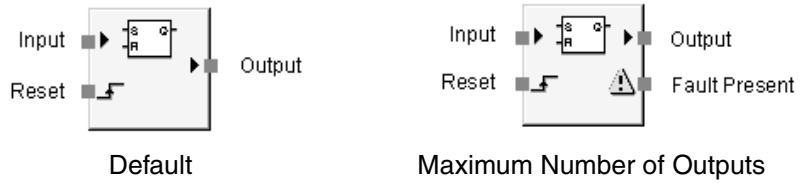

General Description

When the input condition to the Reset Set Flip-Flop function block is turned ON, that ON status is maintained (latched) in the function block and the ON output is maintained at the Output Enable signal.

The ON status is maintained in the function block, so the Output Enable signal stays ON even if the input condition goes from ON to OFF.

The signal maintained in the function block is turned OFF when the function block's RESET condition is turned ON.

Fault Present Output Setting

A Fault Present output can also be used in programming.

To enable this output, select the Fault Present check box on the Output Point Tab Page of the function block properties dialog box.

Error Handling and Error Resetting

Error condition	Behavior for error detection		Resetting the error condition
	Output Enable	Fault Present	
Input and Reset are active simultaneously.	OFF (safety state)	ON	Make one of the signals inactive.

Timing Chart

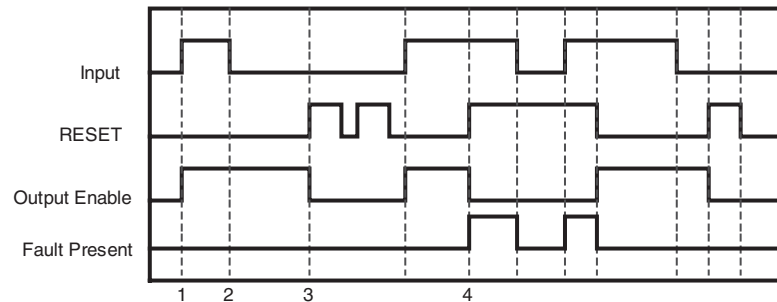

1. The Input signal turns ON, and so the Output Enable signal is turned ON.
2. The ON status is held, and so the Output Enable remains ON.
3. The Reset signal turns ON, and so the hold status is released.
4. The Input and Reset signals turn ON at the same time, and so the Fault Present signal is turned ON.

3-3-9 Comparator

Basic Function

Input signals are compared to the set value, and the Output Enable signal is turned ON when they match.

Diagram

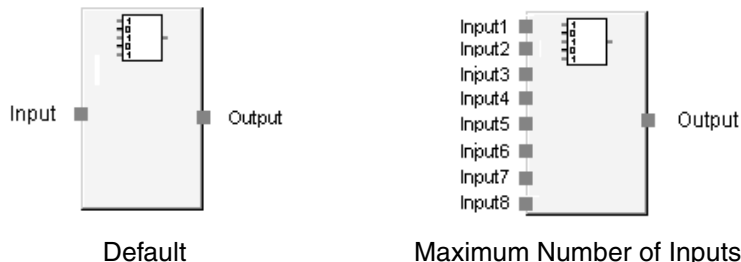

General Description

The Comparator function block compares the specified inputs (up to 8 inputs) with the set parameters, and turns ON the Output Enable signal when all of the inputs match the set values.

The Output Enable signal will be turned OFF when the inputs no longer match the comparison values.

Set Parameters

Parameter	Setting range	Default setting
Comparison Data	00000000 to 11111111 (Bits 0 to 7 correspond to Input 1 to Input 8) (Bit 0 is the least significant bit.)	00000001 (Input 1 is ON.)

Optional Input Settings

The number of inputs can be increased on the In/Out Setting Tab Page in the function block property dialog box.

Parameter	Setting range	Default setting
Number of inputs	1 to 8	1

Truth Table

■ **Truth Table for Comparator Evaluation (CD = Comparison Data):**

Input signals to Comparator								Output signals from Comparator
Input 1	Input 2	Input 3	Input 4	Input 5	Input 6	Input 7	Input 8	Output Enable
≠ CD for bit 0	x	x	x	x	x	x	x	0
x	≠ CD for bit 1	x	x	x	x	x	x	0
x	x	≠ CD for bit 2	x	x	x	x	x	0
x	x	x	≠ CD for bit 3	x	x	x	x	0
x	x	x	x	≠ CD for bit 4	x	x	x	0
x	x	x	x	x	≠ CD for bit 5	x	x	0
x	x	x	x	x	x	≠ CD for bit 6	x	0
x	x	x	x	x	x	x	≠ CD for bit 7	0
= CD for bit 0	= CD for bit 1	= CD for bit 2	= CD for bit 3	= CD for bit 4	= CD for bit 5	= CD for bit 6	= CD for bit 7	1

0: OFF; 1: ON

Note “= CD for bit n” indicates that the Comparator input signals are the same as the comparison data.
 “≠ CD for bit n” indicates that the Comparator input signals are not the same as the comparison data.
 ”x” indicates that the status is not applicable (the input signals and comparison data may or may not be the same).

Timing Chart

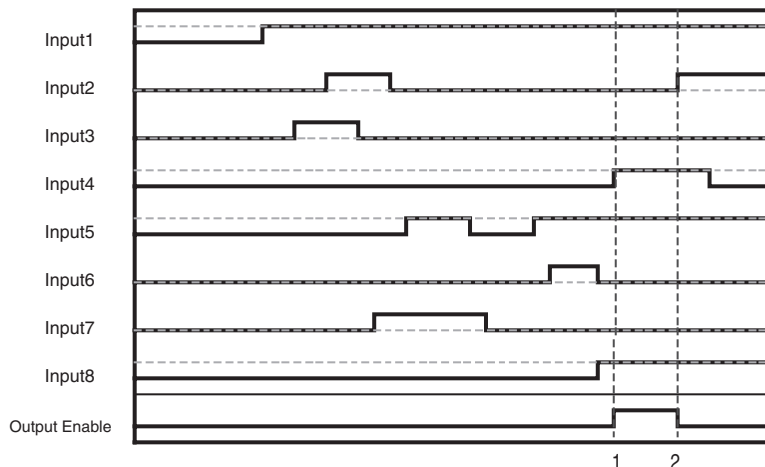

The horizontal broken lines in the above diagram represent the comparison data for each input.

1. Output Enable turns ON when all of the input signals match the comparison data.
2. Output Enable turns OFF when any of the input signals does not match the comparison data.

3-3-10 Comparator2

Basic Function

The input signals are compared to the set value, and the comparison results are output.

Diagram

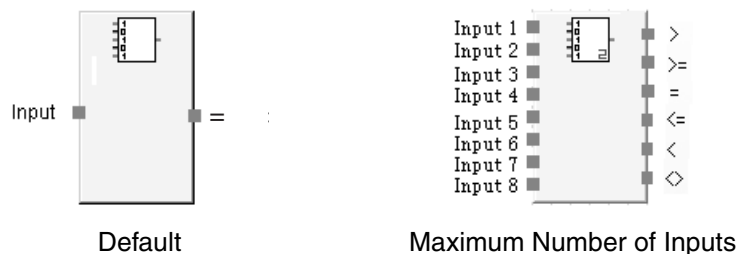

General Description

The Comparator 2 function block compares the inputs (8 max.) with the set parameters as signed 8-bit data, and outputs the comparison results. Input 8 is the leftmost bit, and Input 1 is the rightmost bit.

Set Parameters

Parameter	Setting range	Default setting	
Comparison Data	0x00 (00000000) to 0xFF (11111111) Input 8 is the leftmost bit, and Input 1 is the rightmost bit. The range of values that can be set depends on the number of inputs.	0x01 (00000001) (Input 1 is ON.)	
	Number of Inputs		Range of values
	1		0x00 (0) - 0x01 (1)
	2		0x00 (00) - 0x03 (11)
	3		0x00 (000) - 0x07 (111)
	4		0x00 (0000) - 0x0F (1111)
	5		0x00 (00000) - 0x1F (11111)
	6		0x00 (000000) - 0x3F (111111)
	7		0x00 (0000000) - 0x7F (1111111)
8	0x00 (00000000) - 0xFF (11111111)		

Optional Input Settings

The number of inputs can be increased on the In/Out Setting Tab Page in the function block property dialog box.

Parameter	Setting range	Default setting
Number of inputs	1 to 8	1

Optional Output Settings

The number of outputs can be increased on the In/Out Setting Tab Page in the function block property dialog box.

Output	Meaning
>	ON when the input is greater than the set value in the comparison result. OFF at all other times.
>=	ON when the input is equal to or greater than the set value in the comparison result. OFF at all other times.
=	ON when the input equals the set value in the comparison result. OFF at all other times.
<=	ON when the input is equal to or less than the set value in the comparison result. OFF at all other times.
<	ON when the input is less than the set value in the comparison result. OFF at all other times.
<>	ON when the input does not equal the set value in the comparison result. OFF at all other times.

Truth Table

■ **Truth Table for Comparator 2 Evaluation**

Comparison result	>	>=	=	<=	<	<>
Input > Set value	ON	ON	OFF	OFF	OFF	ON
Input = Set value	OFF	ON	ON	ON	OFF	OFF
Input < Set value	OFF	OFF	OFF	ON	ON	ON

3-4 Timer/Counter Function Blocks

Section	Function Blocks		Support		Page	Compatible unit versions
	Notation in function list	Name	G9SP	NE1A		
3-4-1	Off-Delay Timer	Off-Delay Timer	○	○	34	
3-4-2	On-Delay Timer	On-Delay Timer	○	○	34	
3-4-3	Pulse Generator	Pulse Generator	○	○	35	NE1A-series Controllers with unit version 1.0 or later
3-4-4	Counter	Counter	○	○	36	NE1A-series Controllers with unit version 1.0 or later
3-4-5	Up-Down Counter	Up-Down Counter	○	×	38	
3-4-6	Serial-Parallel Converter	Serial-Parallel Converter	○	×	40	

×: No, ○: Yes

3-4-1 OFF-delay Timer

Basic Function

Time OFF-delay Timer function block performs a timer operation for an OFF delay.

Diagram

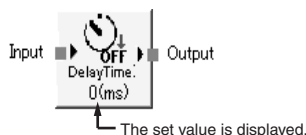

General Description

The OFF-delay Timer function block performs an OFF-delay timer operation.

Set Parameters

Parameter	Setting range	Default setting
Delay Time	0 ms to 300 s in 10-ms increments	0 ms

The delay time must be equal to or greater than the cycle time.

Startup

The timer is restarted.

Timing Chart

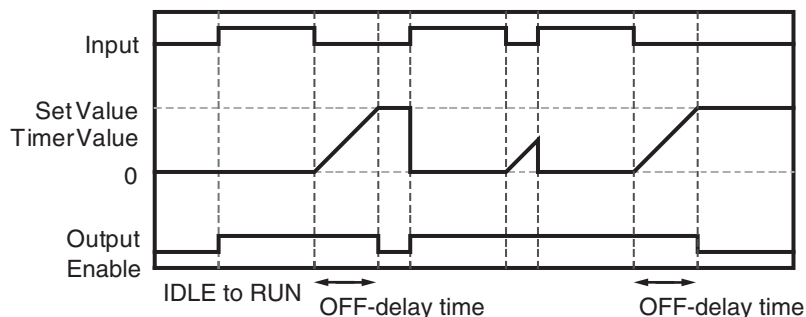

3-4-2 ON-delay Timer

Basic Function

Time ON-delay Timer function block performs a timer operation for an ON delay.

Diagram

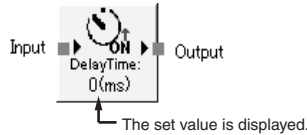

General Description

The ON-delay Timer function block performs an ON-delay timer operation.

Set Parameters

Parameter	Setting range	Default setting
Delay Time	0 ms to 300 s in 10-ms increments	0 ms

The delay time must be equal to or greater than the cycle time.

Startup

The timer is restarted.

Timing Chart

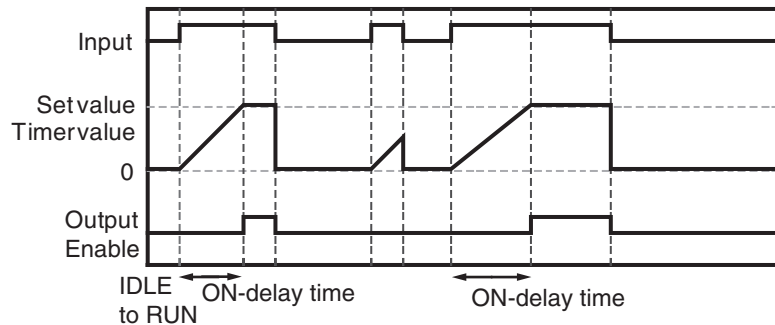

3-4-3 Pulse Generator

Basic Function

The Pulse Generator function block cyclically outputs an ON/OFF pulse on the Output Enable signal while the Input signal is ON.

Diagram

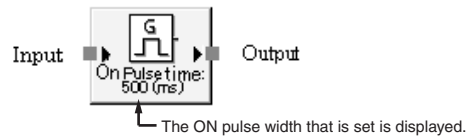

General Description

The Pulse Generator function block cyclically outputs an ON/OFF pulse on the Output Enable signal while the Input signal is ON.

The pulse's ON time and OFF time can be set independently between 10 ms and 3 s, in 10-ms increments. When the ON time is set to 100 ms and the OFF time is set to 500 ms, the signal will repeatedly be turned ON for 100 ms and then OFF for 500 ms. The output is always ON at the start of operation.

Note

An error will occur in the output pulse width between the minimum cycle time multiple that exceeds the timer set value and the minimum cycle time multiple that equals or exceeds the timer set value plus 10 ms. For example, if the cycle time is 7 ms and the pulse width is set to 100 ms, the output pulse will be from 105 to 112 ms.

Startup

The timer is restarted. When the input signal turns ON, operation starts from the ON pulse.

Set Parameters

Parameter	Setting range	Default setting
On Pulse Time	10 ms to 3 s in 10-ms increments	500 ms
Off Pulse Time	10 ms to 3 s in 10-ms increments	500 ms

The timer SV must be longer than the G9SP-series Controller's cycle time.

Timing Chart

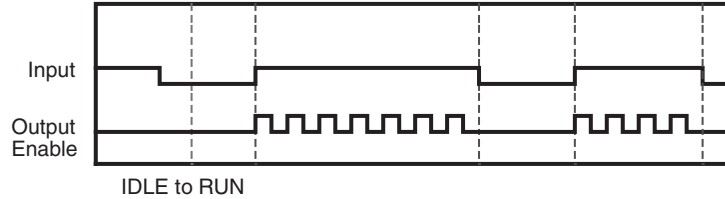

3-4-4 Counter

Basic Function

The Counter function block counts the number of input signals and turns ON the output when the count reaches the specified number.

Diagram

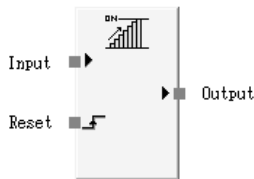

Manual Reset (Default)

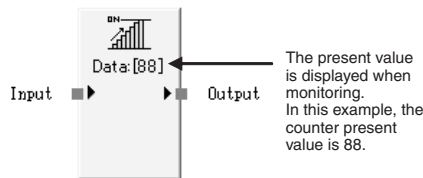

Auto Reset

General Description

The Counter function block counts the number of input pulses on the Input signal and turns ON the Output Enable signal when the count reaches the set value. The function counts the number of OFF-to-ON transitions in the Input signal.

To detect pulses in the input signal, the Input pulse's OFF time and ON time must be longer than the cycle time.

Counting Methods (Count Type)

The Count Type can be set to Down counter or Up counter (decrementing or incrementing counter).

With a down (decrementing) counter, the preset SV is the counter's initial value and the counter decrements the count by 1 each time a rising edge (OFF to ON transition) is detected on the Input signal. The Output Enable signal is turned ON when the count reaches 0.

With an up (incrementing) counter, the counter's initial value is 0 and the counter increments the count by 1 each time a rising edge (OFF to ON transition) is detected on the Input signal. The Output Enable signal is turned ON when the count reaches the preset SV.

**Reset Methods
(Reset Condition)**

The count value (present value) is saved in the function block work area and can be monitored from the Logic Editor.

The Reset Condition used to reset the input count (PV) can be set to Manual Reset or Auto Reset.

Auto Reset

The Output Enable signal is turned ON when the input count reaches the SV. When the input signal turns OFF, the input count is reset. The Output Enable signal remains ON until the Input signal turns OFF, i.e., the Output Enable signal is turned OFF when the Input signal turns OFF.

Manual Reset

The current input count is reset and the Output Enable signal is turned OFF when the Reset signal goes ON. Input pulses will not be counted while the Reset signal is ON. Counting will be continued when the Reset signals turns OFF. Counting will be resumed the next cycle after the Reset signal turns OFF and the Input signal turns ON.

Startup

The count value is reset at the start of operation. If the Input signal is ON, the counter will not operate. The Input signal status must change from OFF to ON before the counter will start operation.

Set Parameters

Parameter	Setting range	Default setting
Reset Condition	Auto Reset Manual Reset	Manual Reset
Count Type	Down counter (decrementing counter) Up counter (incrementing counter)	Down counter (decrementing counter)
Counter	1 to 65,535 (count)	1 (count)

Timing Charts

1. Auto Reset

Decrementing Counter:

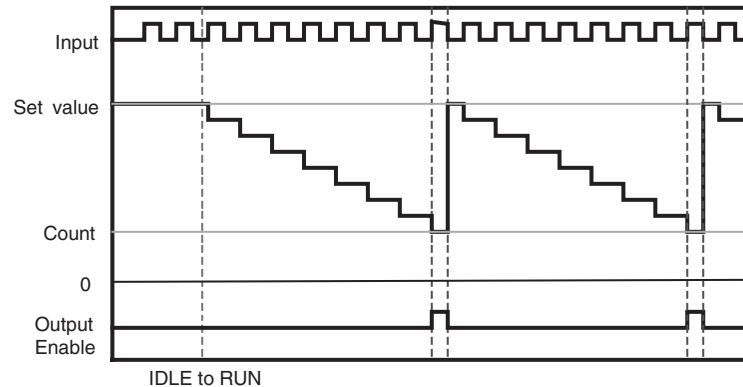

Incrementing Counter:

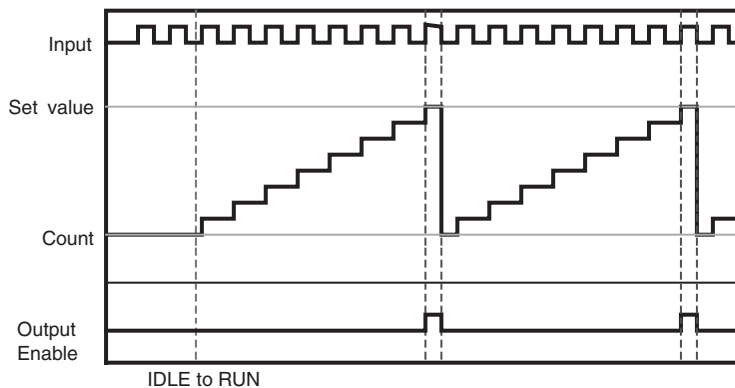

2. Manual Reset

Decrementing Counter:

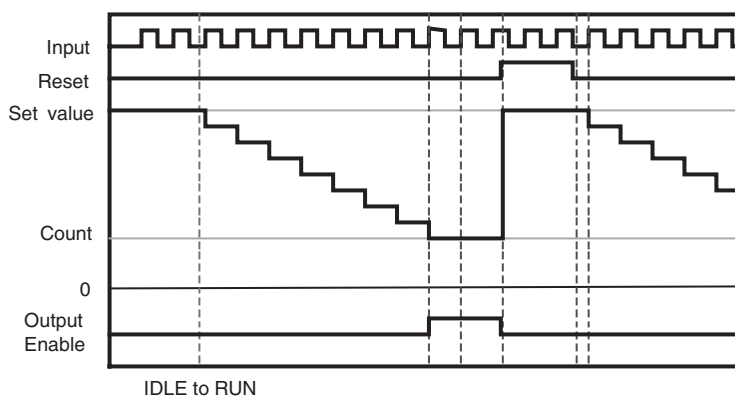

Decrementing Counter:

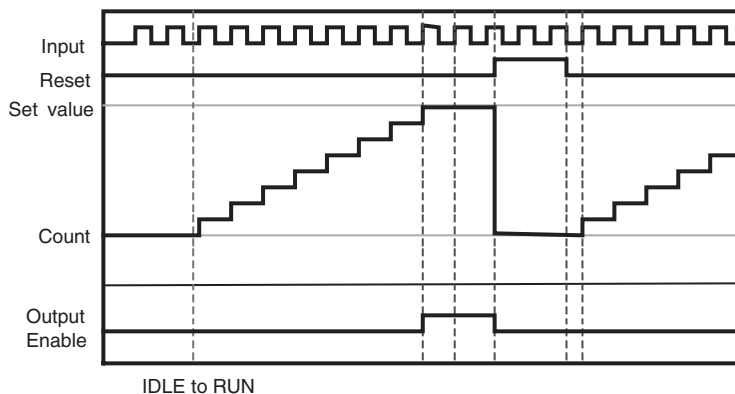

3-4-5 Up-Down Counter

Basic Function

Increments the counter on the rising edge of an up count input and decrements the counter on the rising edge of a down count input.

Diagram

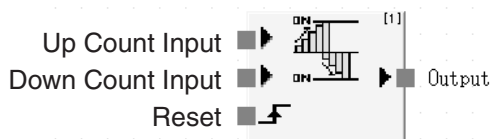

General Description

The Up-Down Counter function block increments the counter on the rising edge (OFF to ON transition) of an up count input and decrements the counter on the rising edge of a down count input. The Output Enable signal turns ON when the present value is incremented to 0 from the set value, and it turns OFF when the present value is incremented from 0 to 1.

The Output Enable signal turns ON when the present value is decremented below 0, and it turns OFF when the present value is decremented from the set value.

For an input signal to be detected, the input OFF and ON times must both longer than the cycle time.

Counter Completion Flag Operation

Incrementing

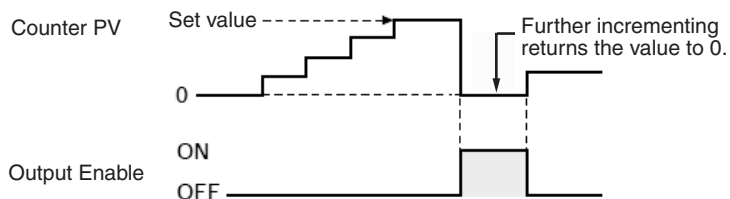

Decrementing

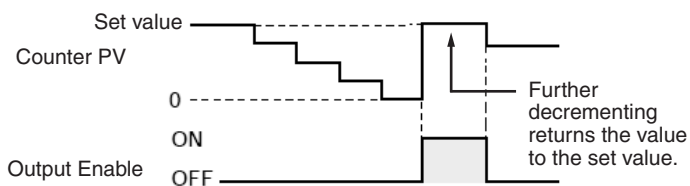

Counting Method

The increment and decrement count inputs are counted once at the rising edge of the signal (i.e., OFF to ON). Neither is counted if both inputs turn ON at the same time.

Reset Methods (Reset Condition)

Only the manual reset can be used to reset the number of times that inputs were counted. When the Reset signal turns ON, the present value of the counter is 0. The Output Enable turns OFF. While the Reset signal is ON, changes in the Input signal are not counted. Counting will be resumed the next cycle after the Reset signal turns OFF and the Input signal turns ON.

Startup

The count value is reset. If the Input signal is ON, the counter will not operate. The input status must change from OFF to ON before the counter will start operation.

Set Parameters

Parameter	Setting range	Default setting
Counter	1 to 65,535 (count)	1 (count)

Timing Charts

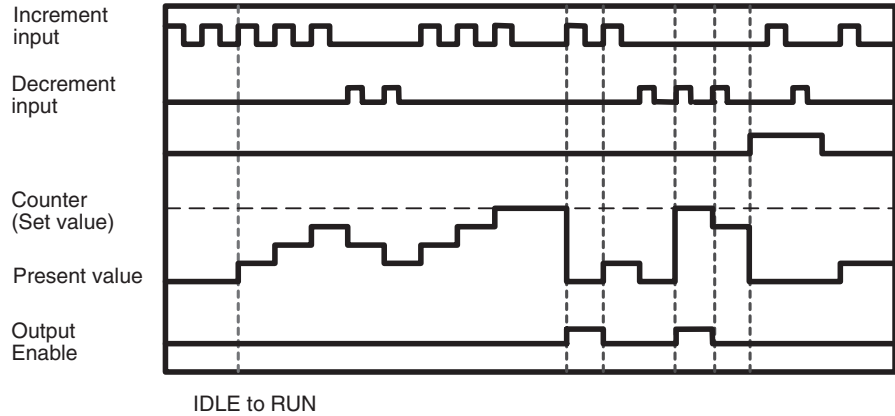

3-4-6 Serial-Parallel Converter

Basic Function

Counts the number of input signals and outputs the count value.

Diagram

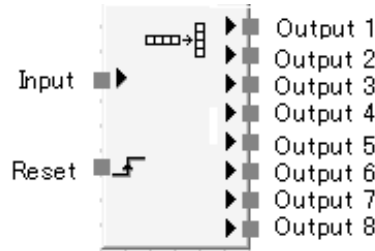

Maximum Number of Outputs (default)

General Description

The Serial-Parallel Converter function block counts the number of input signals and outputs the count value on outputs 1 to 8. The count value is the number of times the Input signal changes from OFF to ON. To detect changes in the Input signal, the OFF time and ON time of the Input signal must both continue at least as long as the cycle time.

Counting Method

An incremental counter is always used. The initial count value is 0 and the count value is incremented each time the rising edge (OFF to ON transition) of the Input signal is detected. The maximum count value is 255. If an Input signal is detected when the count value is 255, the count value will become 0.

Reset Method

Only the manual reset can be used to reset the number of times that inputs were counted. The present value of the counter is reset to 0 when the Reset signal turns ON. Input pulses will not be counted while the Reset signal is ON. Counting will be resumed when the Reset signal turns OFF. Counting will be resumed the next cycle after the Reset signal turns OFF and the input signal turns ON.

Count Output

The 8-bit count value is output to outputs 1 to 8. The relationship between the count value and outputs 1 to 8 is shown in the following table.

Output signal	Output value
Output 1	Bit 0 of the count value
Output 2	Bit 1 of the count value
Output 3	Bit 2 of the count value
Output 4	Bit 3 of the count value

Output signal	Output value
Output 5	Bit 4 of the count value
Output 6	Bit 5 of the count value
Output 7	Bit 6 of the count value
Output 8	Bit 7 of the count value

Startup

The count value is reset at the start of operation. If the Input signal is ON, the counter will not operate. The Input signal status must change from OFF to ON before the counter will start operation.

Set Parameters

Parameter	Setting range	Default
Output Points	1 to 8	8

Timing Chart

Without Reset Input

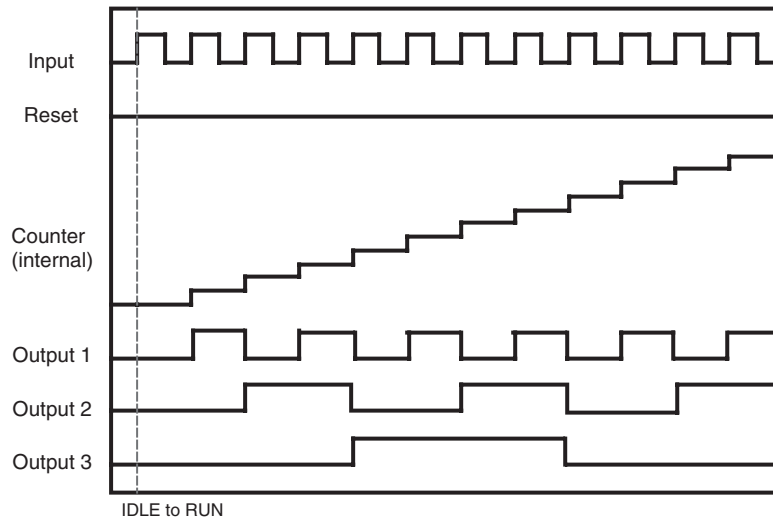

With Reset Input

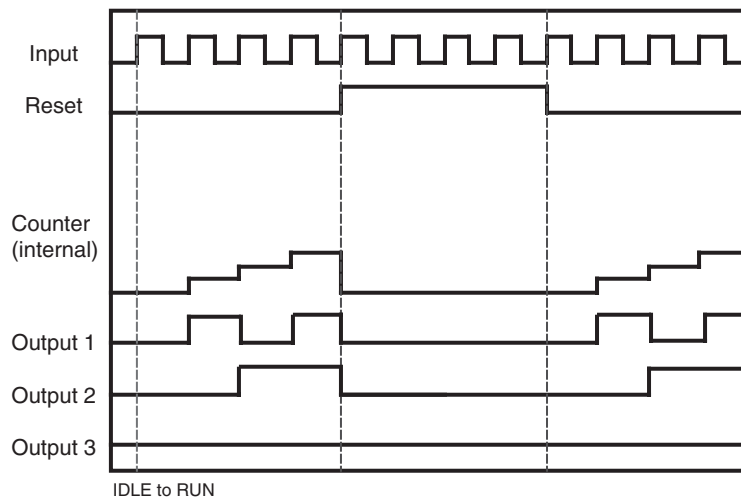

3-5 Safety Device Function Blocks

Section	Function Blocks		Support		Page	Compatible unit versions
	Notation in function list	Name	G9SP	NE1A		
3-5-1	EDM	External Device Monitoring	○	○	43	
3-5-2	Enable Switch	Enable Switch Monitoring	○	○	44	NE1A-series Controllers with unit version 1.0 or later
3-5-3	E-STOP	Emergency Stop Pushbutton Monitoring	○	○	47	
3-5-4	Light Curtain Monitoring	Light Curtain Monitoring	○	○	48	
3-5-5	Muting	Muting	○	○	50	NE1A-series Controllers with unit version 1.0 or later
3-5-10	Safety Gate Monitoring	Safety Gate Monitoring	○	○	65	
3-5-11	Two Hand Controller	Two-hand Controller	○	○	70	
3-5-12	User Mode Switch	User Mode Switch Monitoring	○	○	72	
3-5-13	Redundant Input	Generic Two-input Switch Monitoring	○	×	74	
3-5-14	Single Beam Safety Sensor	Single-beam Safety Sensor Monitoring	○	×	74	
3-5-15	Non-Contact Door Switch	Non-contact Door Switch Monitoring	○	×	74	
3-5-16	Safety Mat	Safety Mat Monitoring	○	×	75	

×: No, ○: Yes

3-5-1 External Device Monitoring (EDM)

Basic Function

The External Device Monitoring function block evaluates the input signal and the status of an external device and outputs safety outputs to an external device. This function block is used to detect fused contacts or external wiring problems (disconnected lines) for safety relays, contactors, and other safety devices.

Diagram

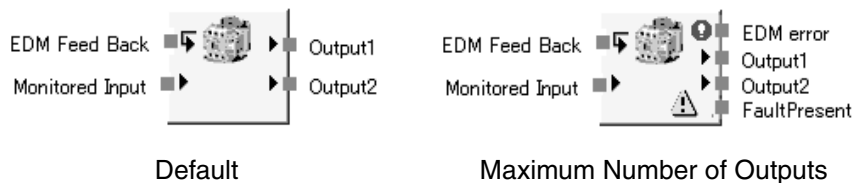

General Description

The External Device Monitoring function block evaluates the input signal and the status of an external device and outputs safety outputs to an external device.

If the Monitored Input signal turns ON, the Output 1 and Output 2 signals will turn ON. When this occurs, the status of the EDM Feedback signal must turn ON within the specified time.

If the Monitored Input signal turns OFF, the Output 1 and Output 2 signals will turn OFF. When this occurs, the status of the EDM Feedback signal must turn ON within the specified time.

If the status of the feedback signal does not change within the specified maximum feedback time, an EDM error will occur, the Output 1 and Output 2 signals will turn OFF, and the EDM Error signal will turn ON.

Startup

All errors are turned OFF and all timers are reset at the start of operation. Outputs are turned ON or OFF according to the input status.

Set Parameters

Parameter	Setting range	Default setting
Maximum Feedback Time (T _{EDM})	100 to 1000 ms in 10-ms increments	300 ms

The timer SV must be longer than the cycle time.

Note If an ON/OFF-delay function block is placed after an EDM function block or an ON/OFF-delay is set for a safety input terminal that inputs EDM feedback, set the value taking those values into consideration.

Optional Output Settings

The following outputs can also be used in programming. To enable either of these optional outputs, select the check box on the Output Point Tab Page of the function block properties dialog box.

- EDM error
- Output 2
Output 2 performs the same operation as output 1.

Fault Present Output Setting

Fault Present output can also be used in programming. To enable this output, select the Fault Present check box on the Output Point Tab Page of the function block properties dialog box.

Error Handling and Error Resetting

Error condition	Behavior for error detection			Resetting the error condition
	Outputs 1 and 2	Fault Present	Error output	
EDM feedback time error	OFF (safety state)	ON	EDM Error output: ON	Remove the error. <ul style="list-style-type: none"> • Turn ON the Monitored Input signal. • Change the operating mode to IDLE Mode and then back to RUN Mode.

Timing Chart

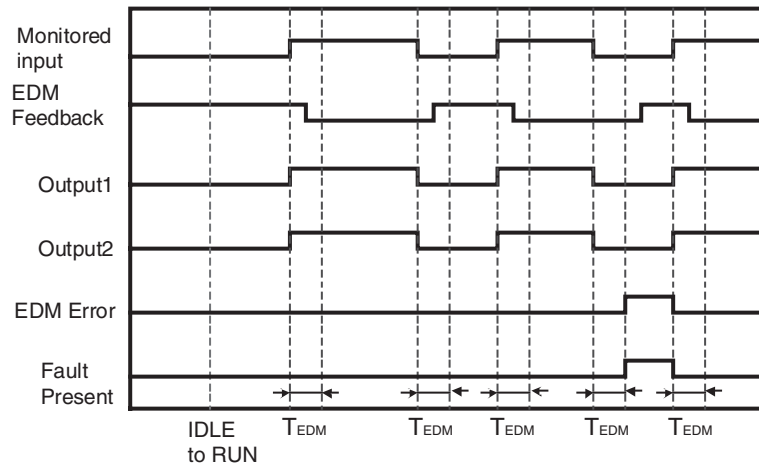

3-5-2 Enable Switch Monitoring (Enable Switch)

Basic Function

The Enable Switch function block monitors the status of the enable-switch device.

Diagram

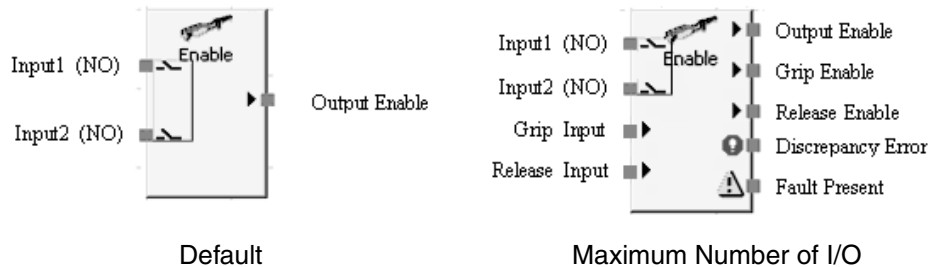

General Description

The Enable Switch function block monitors the status of the enable-switch device.

The Output Enable signal is ON when the input from the monitored enable-switch device is active. The Output Enable signal is OFF when the input is not active or an error is detected in the function block.

In addition, if the enable-switch device is the type that outputs a grip signal and release signal, the device's Grip Input and Release Input signal status can be monitored. The received Grip Input and Release Input signals do not affect the status of the Output Enable signal.

Startup

All errors are turned OFF and all timers are reset at the start of operation. The Output Enable signal will not turn ON if Input 1 is active for a signal-channel input or if Input 1 and Input 2 are active for a dual-channel input. For the Output Enable signal to turn ON, the Input 1 and Input 2 must be made inactive and then made active again.

Set Parameters

Parameter	Setting range	Default setting
Input Type	Single Channel Dual Channel Equivalent	Dual Channel Equivalent
Discrepancy Time	0 to 30 s in 10-ms increments A discrepancy time check will not be performed if 0 is set.	30 ms

The timer SV must be longer than the cycle time.

Number of I/O Points Setting

The Grip Input and Release Input can be enabled and disabled on the In/Out Setting Tab Page in the function block property dialog box.

Parameter	Setting range	Default setting
Number of inputs	2 to 4 (Optional Input Settings) 2: Grip and Release Inputs disabled. 3: Grip Input enabled. 4: Grip and Release Inputs enabled.	2

Optional Output Setting

The following outputs can also be used in programming. To enable any of these optional outputs, select the corresponding check box on the Output Point Tab Page of the function block properties dialog box.

- Grip Enable
- Release Enable
- Discrepancy Error

Fault Present Output Setting

A Fault Present output can also be used in programming. To enable this output, select the Fault Present check box on the Output Point Tab Page of the function block properties dialog box.

Truth Tables

Single Channel Mode

Input 1 (NO)	Output Enable
OFF	OFF
ON	ON

Dual Channel Equivalent Mode

Input 1 (NO)	Input 2 (NO)	Output Enable
OFF	OFF	OFF
OFF	ON	OFF
ON	OFF	OFF
ON	ON	ON

Grip Input and Grip Enable

Grip Input	Grip Enable
OFF	OFF
ON	ON

Release Input and Release Enable

Release Input	Release Enable
OFF	OFF
ON	ON

Error Handling and Error Resetting

Error condition	Behavior for error detection			Resetting the error condition
	Output Enable	Fault Present	Error output	
Discrepancy Error	OFF (safety state)	ON	Discrepancy Error: ON	Remove the cause of the error and then do one of the following: 1. Make the Input inactive and then active again. 2. Change the operating mode to IDLE Mode and then back to RUN Mode.

Timing Charts

Normal Operation and Discrepancy Error:

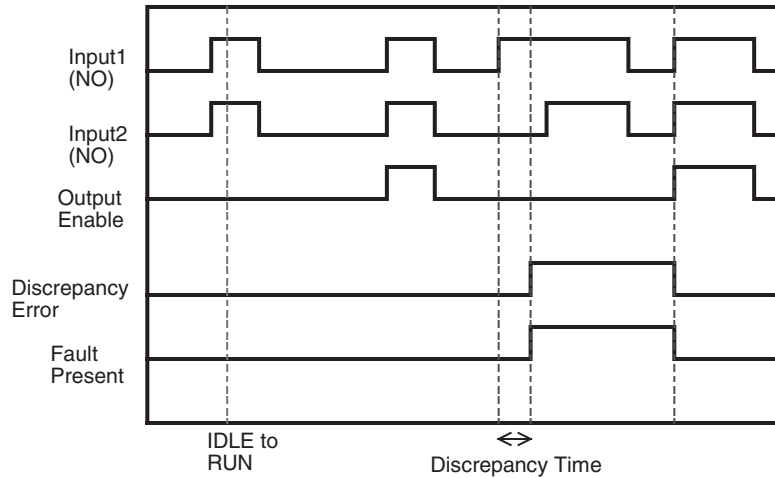

Grip Signal and Release Signal:

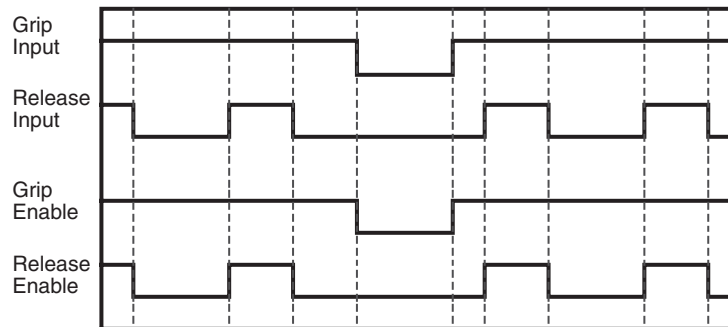

3-5-3 Emergency Stop Pushbutton Monitoring (E-Stop)

Basic Function

The Emergency Stop Pushbutton Monitoring function block allows the user to monitor an emergency stop pushbutton switch.

Diagram

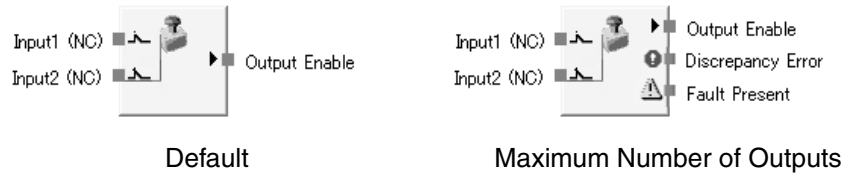

General Description

The Emergency Stop Pushbutton Monitoring function block allows the user to monitor an emergency stop pushbutton switch.

The Output Enable signal will turn ON if the input from the emergency pushbutton being monitored is active. The Output Enable signal will turn OFF if the input is inactive or if an error is detected for the function block.



Precautions for Correct Use

A manual reset function is required for emergency stop applications. When using the Emergency Stop Pushbutton Monitoring function block, you must also use the Reset function block.

Startup

All errors are turned OFF and all timers are reset at the start of operation.

Set Parameters

Parameter	Setting range	Default setting
Input Type	Single Channel Dual Channel Equivalent Dual Channel Complementary	Dual Channel Equivalent
Discrepancy Time	0 to 30 s in 10-ms increments A discrepancy time check will not be performed if 0 is set.	30 ms

The timer SV must be longer than the cycle time.

Optional Output Setting

The following error output can also be used in programming. To enable this optional output, select the check box on the Output Point Tab Page of the function block properties dialog box.

- Discrepancy Error

Fault Present Output Setting

A Fault Present output can also be used in programming. To enable this output, select the Fault Present check box on the Output Point Tab Page of the function block properties dialog box.

Truth Tables

Setting: Single Channel

Input 1 (NC)	Output Enable
0	0
1	1

0: OFF, 1: ON

Setting: Dual Channel Equivalent

Input 1 (NC)	Input 2 (NC)	Output Enable
0	0	0
0	1	0
1	0	0
1	1	1

0: OFF, 1: ON

Setting: Dual Channel Complementary

Input 1 (NC)	Input 2 (NO)	Output Enable
0	0	0
0	1	0
1	0	1
1	1	0

0: OFF, 1: ON

Error Handling and Error Resetting

Error condition	Behavior for error detection			Resetting the error condition
	Output Enable	Fault Present	Error output	
Discrepancy error	OFF (safety state)	ON	Discrepancy Error output: ON	Remove the cause of the error and then do the following: 1. Make the inputs inactive and then active again. 2. Or change the operating mode to IDLE Mode and then back to RUN Mode.

Timing Chart

When Set to Dual Channel Equivalent

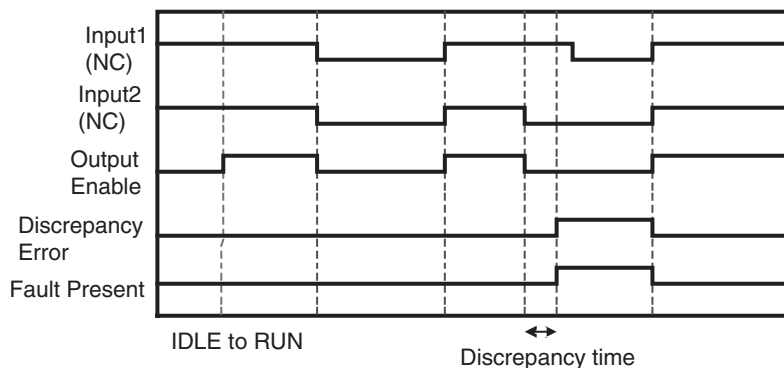

3-5-4 Light Curtain Monitoring

Basic Function

The Light Curtain Monitoring function block monitors a type-4 safety light curtain.

Diagram

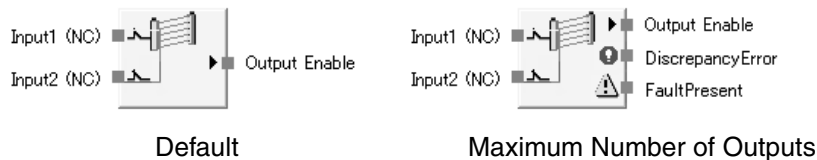

General Description

The Light Curtain Monitoring function block monitors a type-4 safety light curtain.

The Output Enable signal will turn ON if the input from the safety light curtain being monitored is active. The Output Enable signal will turn OFF if the input is inactive or if an error is detected for the function block.

Startup

All errors are turned OFF and timers are reset at the start of operation. Outputs are turned ON or OFF according to the input status.

Set Parameters

Parameter	Setting range	Default setting
Input type	Dual Channel Equivalent Dual Channel Complementary	Dual Channel Equivalent
Discrepancy time	0 to 30 s in 10-ms increments A discrepancy time check will not be performed if 0 is set.	30 ms

The timer SV must be longer than the cycle time.

Optional Output Setting

The following error output can also be used in programming. To enable this optional output, select the check box on the Output Point Tab Page of the function block properties dialog box.

- Discrepancy Error

Fault Present Output Setting

Fault Present output can also be used in programming. To enable this output, select the Fault Present check box on the Output Point Tab Page of the function block properties dialog box.

Truth Tables

Setting: Dual Channel Equivalent

Input 1 (NC)	Input 2 (NC)	Output Enable
0	0	0
0	1	0
1	0	0
1	1	1

0: OFF, 1: ON

Setting: Dual Channel Complementary

Input 1 (NC)	Input 2 (NO)	Output Enable
0	0	0
0	1	0
1	0	1
1	1	0

0: OFF, 1: ON

Error Handling and Error Resetting

Error condition	Behavior for error detection			Resetting the error condition
	Output Enable	Fault Present	Error output	
Discrepancy error	OFF (safety state)	ON	Discrepancy Error output: ON	Remove the cause of the error and then do the following: 1. Make the inputs inactive and then active again. 2. Or change the operating mode to IDLE Mode and then back to RUN Mode.

Timing Chart

When Set to Dual Channel Equivalent

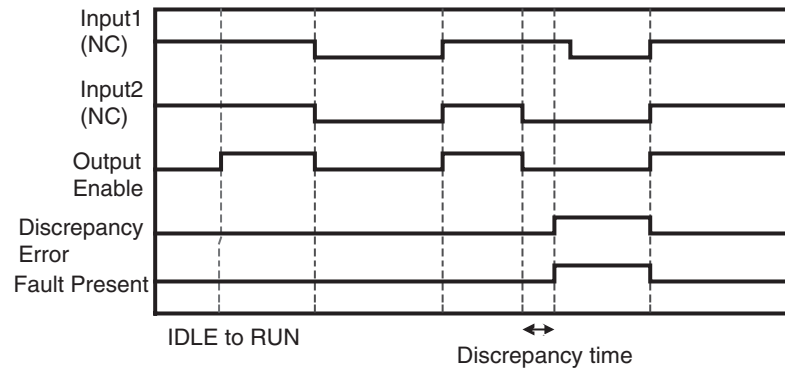

3-5-5 Muting

Basic Function

Temporarily disabled the detection operation of a Safety Light Curtain when a muting sensor is detecting something.

Diagram

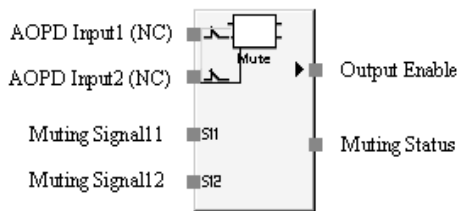

Default

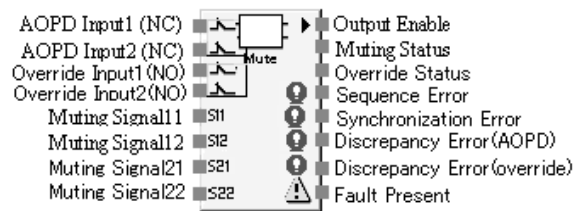

Maximum Number of I/O

General Description

The Muting function block provides both muting and override functions.

Muting

When detection is muted, safety functions are temporarily disabled so that workpieces, pallets, or other objects can be passed through the detection zone of the Safety Light Curtain. With the Muting function block, the input signal to the Safety Light Curtain will be temporarily disabled when the muting start conditions are satisfied, and Output Enable will remain ON until the muting end conditions are satisfied even if the Safety Light Curtain is interrupted.

Supported Muting Applications

Any of the following four muting modes can be selected to enable typical muting applications.

Muting Mode	Application
Parallel Muting with 2 Sensors	This mode is suitable for applications at a conveyor entrance. Use this mode when two Retro-reflective Photoelectric Sensors are set up as the muting sensors with intersecting detection zones.
Sequential Muting in Forward Direction	This mode is suitable for applications at a conveyor entrance. Use this mode when four Through-beam Photoelectric Sensors are set up as the muting sensors.
Sequential Muting in Both Directions	This mode is suitable for applications at a conveyor entrance or exit. Use this mode when four Through-beam Photoelectric Sensors are set up as the muting sensors.
Position Detection	This mode is suitable for applications in which the operator sets the workpiece and then the workpiece is moved to the processing area by a turn table or workpiece conveyor robot. Muting is enabled by detecting that the robot is in a safe location using a limit switch or other device. Use this mode to temporarily disable the light curtain when the operator sets the workpiece at the conveyor entrance.

Muting Starting, Ending, and Stopping Conditions

Starting Conditions

Muting status will turn ON if the following muting detection conditions are all satisfied. (For position detection, conditions 4 and 5 are not required. Muting status will be started when the muting sensor turns ON.)

1. The AOPD signal must be active (light to the light curtain must not be obstructed).
2. There must be no discrepancy errors, synchronization errors, or sequence errors.
3. All the muting sensors must be OFF.
4. The two muting sensors in condition 3 must detect in the normal sequence.
5. The synchronization time of the two muting sensors in condition 3 must be within the normal range.

If an error occurs in the above conditions, the following alarms will be output.

- A sequence error will be output if the two muting sensors are not detected in the normal sequence.
- A synchronization error will be output if the synchronization time of the two muting sensors is not detected in the normal range.

Also, Output Enable will turn OFF if the AOPD signal becomes inactive (light obstructed) before the muting status is achieved.

Stopping Conditions (Ending Conditions)

Muting will be stopped and muting status will turn OFF if any of the following conditions occur:

1. The system enters any of the following status from muting status.

Muting Mode	Ending condition
Parallel Muting with 2 Sensors	Muting signal 11 or 12 turns OFF.
Sequential Muting in Forward Direction	Muting signals 11, 12, and 21 turn OFF.
Sequential Muting in Both Directions	Input Sequence Muting signals 11, 12, and 21 turn OFF.
	Output Sequence Muting signals 12, 21, and 22 turn OFF.
Position Detection	Muting signal 11 turns OFF.

2. The maximum muting time has elapsed. In the following cases, however, muting will stop and Output Enable will also turn OFF.
3. The light curtain is obstructed with the muting status stopped in conditions 1 or 2.
4. A discrepancy error has occurred in the AOPD signal.
5. A discrepancy error has occurred in the override signal (for dual setting only).

Note The muting status will return if the muting start conditions are satisfied.

Note In the above description, the muting sensors are ON when the workpiece is detected and OFF when it is not detected.

Override Function

The override function can be used, for example, to force a machine to operate to remove an object that has stopped in the detection zone of the Safety Light Curtain. The override function enables turning ON the Output Enable signal even when the muting starting condition has not been satisfied.

Override Starting and Stopping Conditions

Starting Conditions

The override will be started and Output Enable and Override Status will turn ON when all of the following conditions are satisfied. The muting status will turn ON.

1. At least one of the muting signals must be ON (i.e., the muting sensor must be detecting a workpiece).
2. The AOPD inputs must be inactive (i.e., the Safety Light Curtain must be obstructed).
3. Override input must be ON (for Single Input) or active (for Dual Inputs)

Note Override, however, will not start when operation starts.

Stopping Condition (Ending Condition)

Override will be stopped and Override Status will turn OFF when any of the following conditions occurs. If the AOPD inputs are inactive (i.e., the Safety Light Curtain is obstructed), the Output Enable signal will turn OFF.

1. All of the muting signals are OFF (i.e., the muting sensor must not be detecting a workpiece).
2. The maximum override time has elapsed.
3. Override input is OFF (for Single Input) or Inactive (for Dual Input).

Startup

All faults are turned OFF and all timers are reset at the start of operation. Outputs are turned ON or OFF according to the input status.

Set Parameters

Parameter	Setting range	Default setting
Muting Mode (See note 1.)	<ul style="list-style-type: none"> Position detection Parallel Muting with 2 Sensors Sequential Muting in Forward Direction Sequential Muting in Both Directions 	Parallel Muting with 2 Sensors
Synchronization Time (See note 3.)	30 ms to 3 s in 10-ms increments (See note 2.)	3 s
Input Type of AOPD	<ul style="list-style-type: none"> Dual Channel Equivalent (NC/NC) Dual Channel Complementary (NC/NO) 	Dual Channel Equivalent
Discrepancy Time (AOPD)	10 to 500 ms in 10-ms increments (See note 2.) A discrepancy time check will not be performed if 0 is set.	30 ms
Input Type of Override	<ul style="list-style-type: none"> Single Channel Dual Channel Equivalent (NO/NO) Dual Channel Complementary (NC/NO) Not used. 	Not used.
Discrepancy Time (Override)	10 to 500 ms in 10-ms increments (See note 2.) A discrepancy time check will not be performed if 0 is set.	30 ms
Max Override Time	500 ms to 127.5 s in 500-ms increments	60 s
Max Muting Time	500 ms to 127.5 s in 500-ms increments The muting time will be unlimited if 0 is set.	60 s

- Note**
- (1) The Muting Signals are set according to the Muting Mode.
 - (2) The timer SV must be longer than the cycle time.
 - (3) Sets the time between Muting Signal 11 and Muting Signal 12 or between Muting Signal 21 and Muting Signal 22.

Optional Output Settings

The following outputs can also be used in programming. To enable any of these optional outputs, select the check box on the Output Point Tab Page of the function block properties dialog box.

- Override Status
- Synchronization Error
- Sequence Error
- Discrepancy Error (AOPD)
- Discrepancy Error (Override)

Fault Present Output Setting

A Fault Present output can also be used in programming.

To enable this output, select the Fault Present check box on Output Point Tab Page of the function block properties dialog box.

Error Handling and Error Resetting**Synchronization Error**

A synchronization error can be detected in any mode other than Position Detection Mode.

A synchronization error will occur and Synchronization Error will turn ON if the time difference between input signals for the muting signals (i.e., muting sensors) exceeds the synchronization time that has been set. If the AOPD inputs turns OFF (i.e., if the Safety Light Curtain is obstructed) while there is a synchronization error, the Output Enable signal will turn OFF. Fault Present will turn ON at the following times.

- When AOPD input turns OFF.

The condition for a synchronization error are give for each muting mode in the following table.

Muting Mode	Condition for synchronization error
Parallel Muting with 2 Sensors	The time difference between muting signal 11 and muting signal 12 has exceeded the set value of the synchronization time.
Sequential Muting in Forward Direction	The time difference between muting signal 11 and muting signal 12 has exceeded the set value of the synchronization time.
Sequential Muting in Both Directions	Input Sequence The time difference between muting signal 11 and muting signal 12 has exceeded the set value of the synchronization time.
	Output Sequence The time difference between muting signal 21 and muting signal 22 has exceeded the set value of the synchronization time.
Position Detection	Not detected.

Sequence Error

A sequence error will occur and Sequence Error will turn ON if the muting signals (i.e., muting sensors) are not detected in the correct order.

If the AOPD inputs turns OFF (i.e., if the Safety Light Curtain is obstructed) while there is a sequence error, the Output Enable signal will turn OFF. The Fault Present signal will turn ON at the following times.

- When AOPD input turns OFF.

The following table lists the normal sequence for each muting mode.

Muting Mode	Normal sequence
Parallel Muting with 2 Sensors	Muting signal 11 is detected, and then muting signal 12 is detected.
Sequential Muting in Forward Direction	Muting signal 11 is detected, and then muting signal 12 is detected.
Sequential Muting in Both Directions	Input Sequence Muting signal 11 is detected, and then muting signal 12 is detected.
	Output Sequence Muting signal 22 is detected, and then muting signal 21 is detected.
Position Detection	AOPD input turning OFF is detected while muting signal 11 is ON.

Note All muting signals must turn OFF before the normal sequence. (Sequence error detection starts after all of the muting signals turn OFF.)

Discrepancy Error

The discrepancy time is monitored each time the AOPD Input and Override Input are input. For information on the monitoring method. AOPD Input outputs to Discrepancy Error (AOPD) and Override Input outputs to Discrepancy Error (Override). Refer to the following table (*Resetting Errors*) for information on outputs to Fault Present.

Resetting Errors

Error	Operation when error occurs			Resetting
	Output Enable	Fault Present	Error output	
Discrepancy error during AOPD input	OFF (safe state)	ON	Discrepancy Error (AOPD): ON	<ul style="list-style-type: none"> • Change the safety light curtain input pair (AOPD inputs 1 and 2) from inactive to active. • Change to IDLE Mode and then return it to RUN Mode.
Discrepancy error during override input			Discrepancy Error (Override): ON	
Synchronization error	Same as AOPD input (See note.)	Same as AOPD input (See note.)	Synchronization Error: ON	<ul style="list-style-type: none"> • The error will be reset the next time a normal muting status is enabled. • Change to IDLE Mode and then return it to RUN Mode.
Sequence error			Sequence Error: ON	

Note If the AOPD input turns OFF (i.e., safety light curtain obstructed) while there is a synchronization or sequence error, Output Enable will turn OFF and Fault Present will turn ON.

■ **Timing Chart**

Synchronization Error (Muting Mode: Parallel Muting with 2 Sensors)

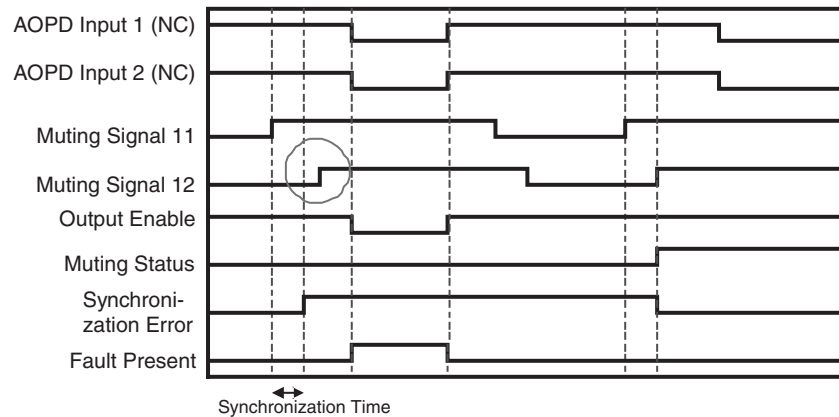

Example Muting System Configurations

■ **Parallel Muting with 2 Sensors**

In this example, two Retro-reflective Photoelectric Sensors are set up as the muting sensors with intersecting detection zones.

Use this configuration when the workpiece length (L) is not fixed or not long enough.

Block Diagram

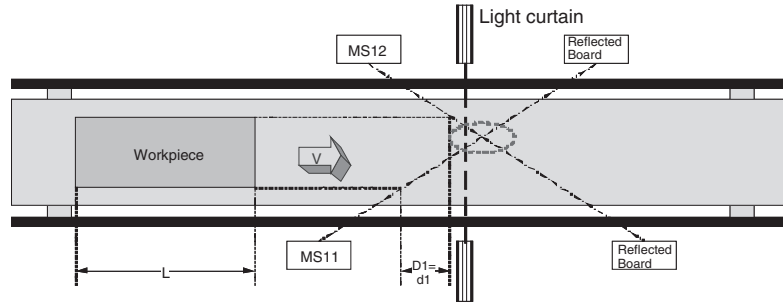

MS11: Muting sensor connected to Muting Signal 11

MS12: Muting sensor connected to Muting Signal 12

Note The intersection of the two sensors must be after the light curtain.

Muting Sequence

1. In the block diagram above, the light is not interrupted between MS11 and MS12 and the light curtain, so the Output Enable signal is ON.
2. As the workpiece moves to the right and MS11 and MS12 go ON in order, muting is enabled.
3. As the workpiece continues advancing, the Output Enable signal is kept ON even if the Safety Light Curtain is obstructed (i.e., even if the AOPD inputs are OFF).
4. As the workpiece continues advancing, the light from MS11 is no longer interrupted by the workpiece, the muting status is cleared and the Muting Status will go OFF.

Setup Distances

The following formula shows the minimum distance of D1 required for the muting sensors to provide effective muting function operation:

Formula 1: $D1 < L$

L: Length of the workpiece

The following formula shows the maximum distance of d1 required for the muting sensors to provide effective muting function operation:

Formula 2: $V \times T1min < d1 < V \times T1max$

V: Transit speed of the workpiece

T1min: G9SP-series Controller cycle time

T1max: Synchronization time setting time

The default setting is 3 s.

D1 must satisfy formula 1 and d1 must satisfy formula 2 in order for the muting function to be operate effectively. These distance settings must prevent a passing person from enabling the muting function. Also, the light curtain and muting sensors must be setup so that a workpiece passes by all of the muting sensors before the next workpiece arrives at the muting sensors.

■ Timing Chart

Normal Operation

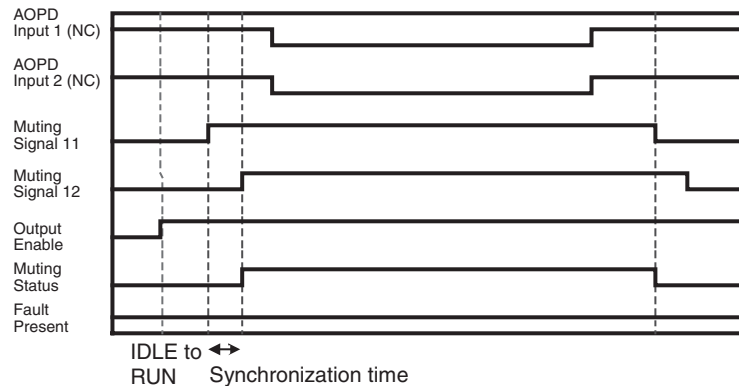

Muting Starting Conditions

Muting Status will turn ON when all of the following muting detection conditions are satisfied.

1. The AOPD signals must be active (light to the Safety Light Current must not be obstructed).
2. There must be no discrepancy errors.
3. Both of the muting sensors must be OFF.
4. The two muting sensors in condition 3 must detect in the normal sequence.
5. The synchronization time of the two muting sensors in condition 3 must be within the normal range.

If an error occurs in the above conditions, the following alarms will be output.

- A sequence error will be output if the two muting sensors are not detected in the normal sequence.
- A synchronization error will be output if the synchronization time of the two muting sensors is not detected in the normal range.

Also, the Output Enable signal will turn OFF if the AOPD signals become inactive (light obstructed) before the muting status is achieved.

Muting Stopping Conditions (Ending Conditions)

Muting status will be stopped and Muting Status will turn OFF if any of the following conditions occurs.

1. Muting signal 11 or 12 turns OFF in muting status.
2. The Max. Muting Time has elapsed.

Muting and Output Enable will both turn OFF in the following cases.

3. The Safety Light Current is obstructed when muting is stopped in conditions 1 and 2.
4. A discrepancy error occurs in the AOPD signal.
5. A discrepancy error occurs in the override signal (for Dual setting).

Note The muting status will return when the muting starting conditions are satisfied.

Note In the above description, the muting sensor is ON when it detects the work-piece and OFF when it does not.

■ Sequential Muting in Forward Direction

In this example, four Through-beam Photoelectric Sensors are set up as the sensors with intersecting detection zones. Use this configuration when the length of the workpiece being transported is longer than a fixed length.

Block Diagram

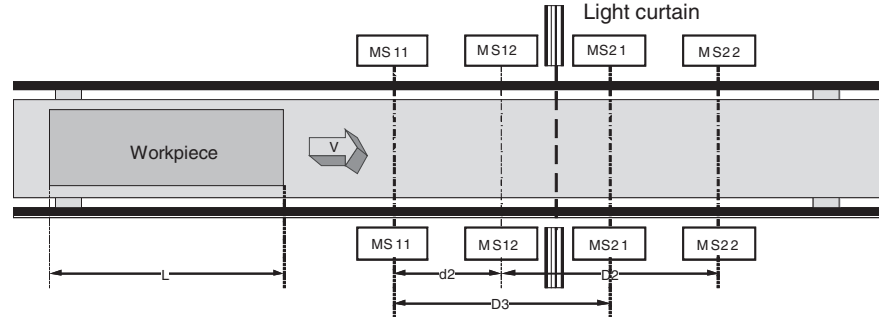

- MS11: Muting sensor connected to Muting Signal 11
- MS12: Muting sensor connected to Muting Signal 12
- MS21: Muting sensor connected to Muting Signal 21
- MS22: Muting sensor connected to Muting Signal 22

Muting Sequence

1. In the block diagram above, the light is not interrupted between MS11, MS12, MS21, and MS22 and the Safety Light Current, so the Output Enable signal is ON.
2. As the workpiece moves to the right and MS11 and MS12 go ON in order, muting is enabled, and the Muting Status goes ON.
3. As the workpiece continues advancing, the Output Enable signal is kept ON even if the Safety Light Current is obstructed.
4. As the workpiece continues advancing, light from MS21 is no longer interrupted by the workpiece, the muting status is cleared, and the Muting Status goes OFF.

Setup Distances

The following formulae show the minimum distances of D2 and D3 required for the muting sensors to provide effective muting function operation:

Formula 3: $D2 < L$

Formula 4: $D3 < L$

L: Length of the workpiece

The following formula shows the maximum distance of d2 required for the muting sensors to provide effective muting function operation:

Formula 5: $V \times T1min < d2 < V \times T1max$

V: Transit speed of the workpiece

T1min: G9SP-series Controller cycle time

T1max: Synchronization time setting time

The default setting is 3 s.

D2 must satisfy formula 3, D3 must satisfy formula 4, and d2 must satisfy formula 5 in order for the muting function to operate. These distance settings must prevent a passing person from enabling the muting function. Also, the Safety Light Current and muting sensors must be setup so that a workpiece passes by all of the muting sensors before the next workpiece arrives at the muting sensors.

■ **Timing Chart**

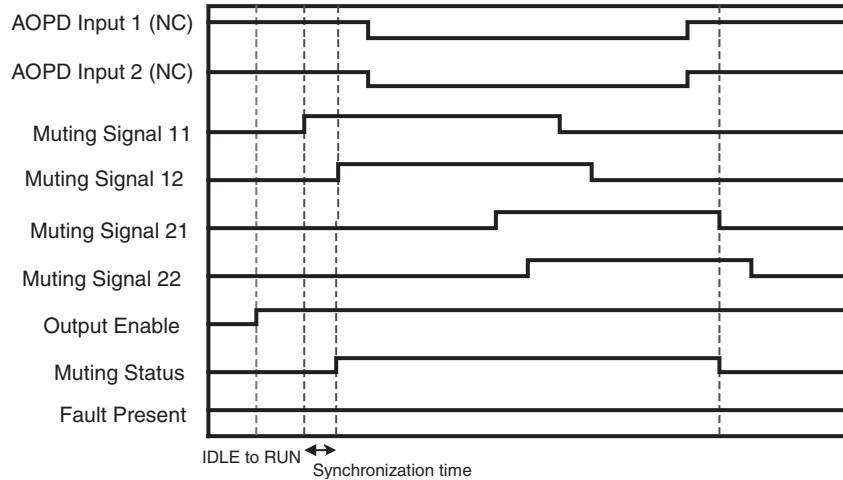

Muting Starting Conditions

1. Sequence Check

Detection will be performed in order from Sensor MS11 to Sensor MS12. Sequence errors will occur in the following cases.

- S2 is detected first.
- MS11 and MS12 are detected at the same time.
- MS21 or MS22 is ON when MS11 and MS12 are detected.

2. Synchronization Time Check

The time (T1) from when MS11 is detected until MS12 is detected must not be greater than the maximum synchronization time. A synchronization error will occur in the following case.

- The maximum synchronization time from detecting MS11 until detecting MS12 has elapsed.

Muting Ending Conditions

1. Sequence Check

- If two or more Sensors are not ON, muting is ended.

Note Muting will also end if the sensor status is not valid.

2. Maximum Time Check

- If the muting time exceeds the maximum muting time, muting is ended.

Note The time for Safety Light Current muting to turn OFF is not monitored.

■ Sequential Muting (Both Directions)

Block Diagrams

1. Entrance

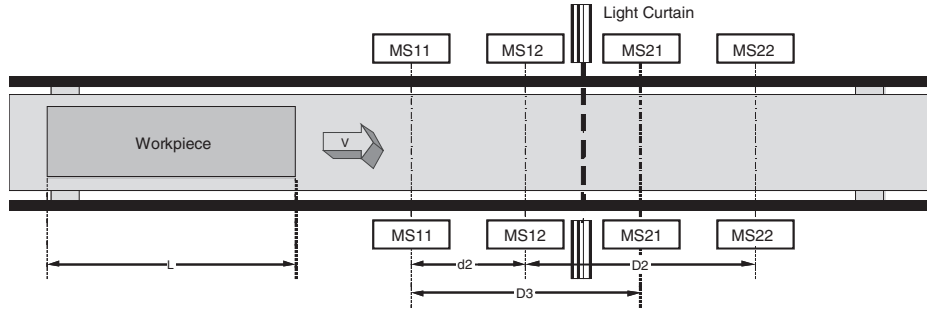

2. Exit

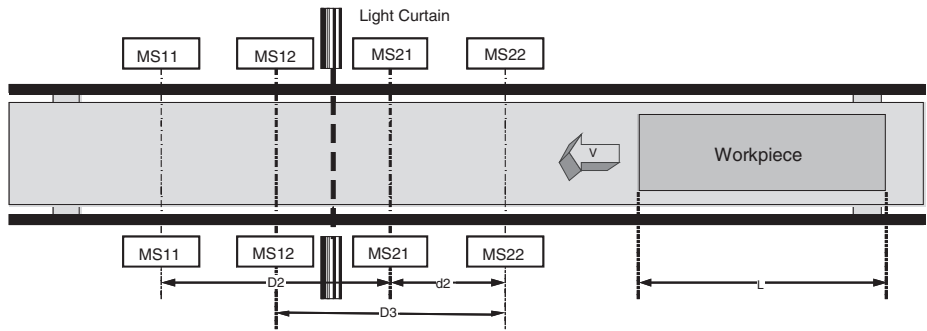

- MS11: Muting sensor connected to Muting Signal 11
- MS12: Muting sensor connected to Muting Signal 12
- MS21: Muting sensor connected to Muting Signal 21
- MS22: Muting sensor connected to Muting Signal 22

Muting Sequence

1. In the block diagram above, the light is not interrupted between MS11, MS12, MS21, and MS22 and the Safety Light Current, so the Output Enable signal is ON.
2. For the entrance, as the workpiece moves to the right and MS11 and MS12 go ON in order (MS22 and MS21 go ON in order at the exit), muting is enabled, and the Muting Status goes ON.
3. As the workpiece continues advancing, the Output Enable signal is kept ON even if the Safety Light Current is obstructed.
4. As the workpiece continues advancing, the workpiece is no longer detected by MS21 at the entrance (MS12 at the exit), the muting status is cleared, and the Muting Status goes OFF.

Setup Distances

The setup distance requirements are the same as for *Sequential Muting in Forward Direction*.

■ **Timing Charts**

Entrance

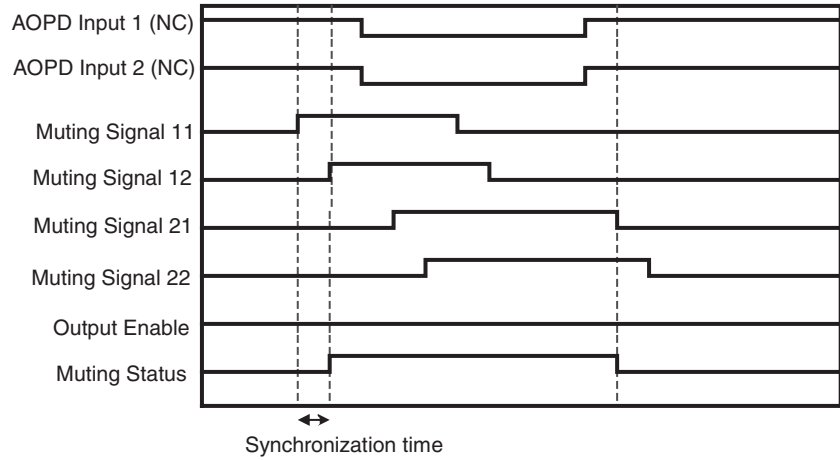

Exit

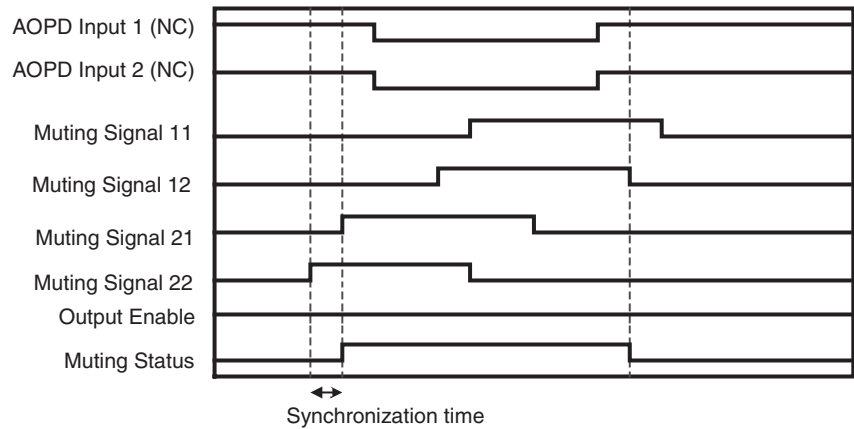

Muting Starting Conditions

1. Sequence Check

An entrance sequence occurs if Sensor MS11 is detected first. An exit sequence occurs if Sensor MS22 is detected first.

1. Conditions for All

A sequence error occurs in the following case.

- MS12 or MS21 is detected first.

2. Entrance

Detection is performed in the order of MS11 to MS12. A sequence error will occur in the following cases.

- MS11 and MS12 are detected at the same time.
- ON is detected for MS21 or MS22.

3. Exit

Detection will be performed in the order of MS22 to MS21. A sequence error will occur in the following cases.

- MS21 and MS22 are detected at the same time.
- ON is detected for MS11 or MS12.

2. Synchronization Time Check

1. Entrance

The time (T1) from when MS11 is detected until MS12 is detected must not be greater than the maximum synchronization time. A synchronization error will occur in the following case.

- The maximum synchronization time from detecting MS11 until detecting MS12 has elapsed.

2. Exit

The time (T1) from when MS22 is detected until MS21 is detected must not be greater than the maximum synchronization time. A synchronization error will occur in the following case.

- The maximum synchronization time from detecting MS22 until detecting MS21 has elapsed.

Muting Ending Conditions

1. Sequence Check

- If two or more Sensors are not ON, muting will end.

Note Muting will also end if the sensor status is not valid.

2. Maximum Time Check

- If the muting time exceeds the maximum muting time, muting will end.

Note The time for Safety Light Current muting to turn OFF is not monitored.

■ **Position Detection**

In this application, the workpiece is mounted on a machine turntable surrounded by a guard fence. The operator can disable the light-interruption signal of the light curtain safety function in order to set a workpiece on the turntable when he is on the opposite side of the machine's dangerous area.

Block Diagram

Machine's Dangerous Area is on the Operator's Side (Figure 1):

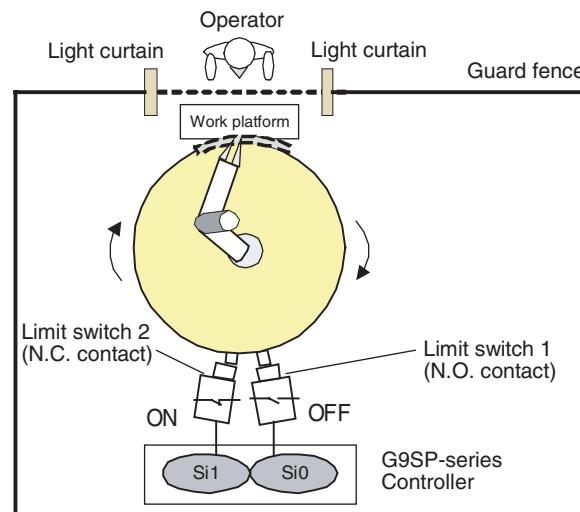

Machine's Dangerous Area is on the Opposite Side of the Operator (Figure 2):

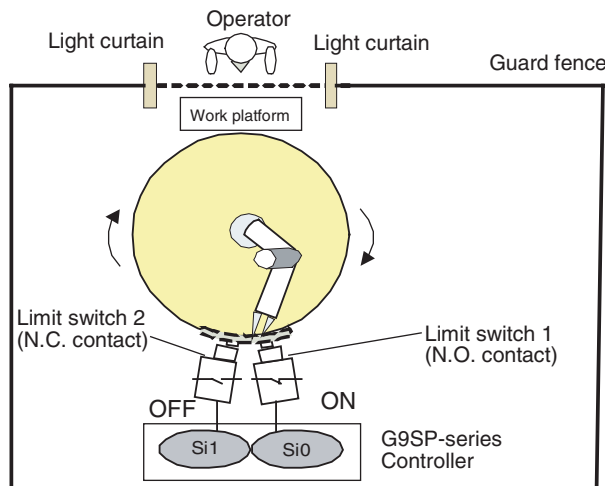

Note In the above example, limit switch 1 (S1) is wired to Si0 on the G9SP-series Controller and limit switch 2 (S2) is wired to Si1. Set the dual channel mode for local inputs in the G9SP-series Controller to dual channel complementary.

Program Example

Limit switches 1 and 2 connected to Si0 and Si1 on the G9SP-series Controller are connected to Muting Signal 11 of the Muting function block through the Safety Gate Monitoring function block.

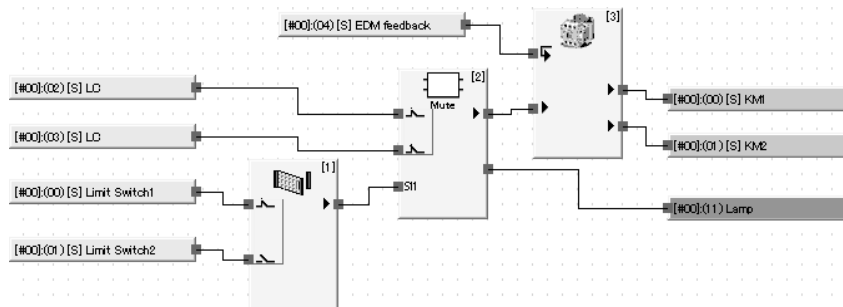

Note Limit switches 1 and 2 are set to the dual channel complementary setting for local inputs to evaluate the input data from the two switches.

Note The Safety Gate Monitoring function block is used as a function block for the limit switches. Set the input type of the Safety Gate Monitoring function block to Dual Channel Complementary (1 pair).

Muting Sequence

1. In figure 1 above, N.O. limit switch 1 is OFF and N.C. limit switch 2 is ON. In addition, the light curtain is not obstructed, so the Output Enable signal is ON. Muting Signal 11, which inputs the dual channel complementary signal for limit switches 1 and 2, goes OFF.
2. As the robotic arm rotates, limit switch 1 goes ON and limit switch 2 goes OFF as shown in figure 2. Muting Signal 11, which inputs the dual channel complementary signal for limit switches 1 and 2, goes ON, so muting is enabled, and the Muting Status goes ON.
3. At this point, the Output Enable signal is kept ON even if the Safety Light Current is obstructed so the operator can access the work platform.

- When the operator completes his task and the Safety Light Current is unobstructed as the robotic arm rotates, Muting Signal 11 goes OFF, the muting status is cleared, and the Muting Status goes OFF.

■ Timing Chart

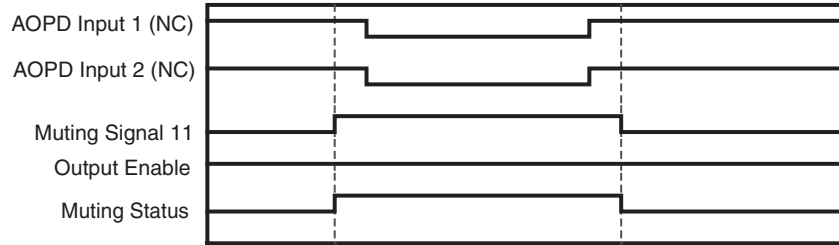

Conditions Required for Muting to Start

1) Sequence Check

- MS 11 turning ON is detected. S1 must be ON and S2 must be OFF.

Note Muting is not started at the start of operation (i.e., when changing from IDLE to RUN mode). MS11 must change from OFF to ON.

Conditions Required for Muting to End

1) Sequence Check

- MS11 turning OFF is detected. S1 must be OFF and S2 must be ON.

2) Maximum Time Check

- The maximum muting time has been exceeded.

Note The time for Safety Light Current muting to turn OFF is not monitored.

Override Function

The Override function can turn ON the safety output ON even though the light interruption signal of the Safety Light Current is inactive. If a workpiece gets jammed during transit as shown in the following diagram, the system cannot be returned to normal operation without forcibly removing the workpiece. In a situation like this, the Override function can be used to move the workpiece out of the light curtain detection zone.

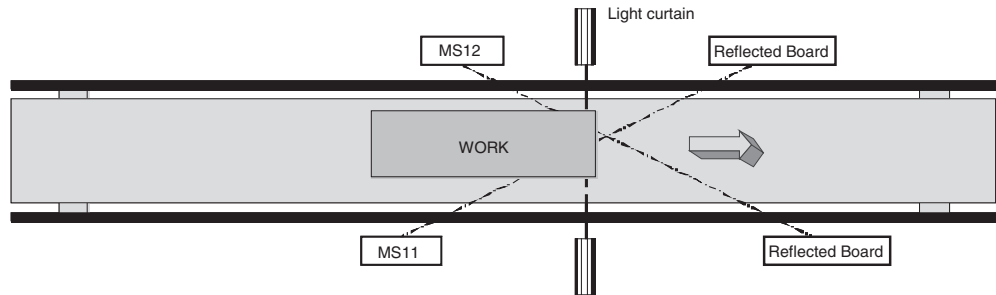

MS11: Muting sensor connected to Muting Signal 11

MS12: Muting sensor connected to Muting Signal 12

Override Sequence

- In the block diagram above, the Output Enable signal is OFF.
- When the Override Input goes ON, the Override starts and the Override Status goes ON. As long as the Override Input is ON, the muting status is continued, and the Output Enable signal is ON.

- When the workpiece moves to the right until it is no longer detected by the MS12, the muting status set for the Override will be cleared, and the Override Status will go OFF.

Note Muting Status

- ON during muting due to override function.

■ **Timing Chart**

Normal Operation of the Override Function (Muting Mode: Parallel Muting with 2 Sensors)

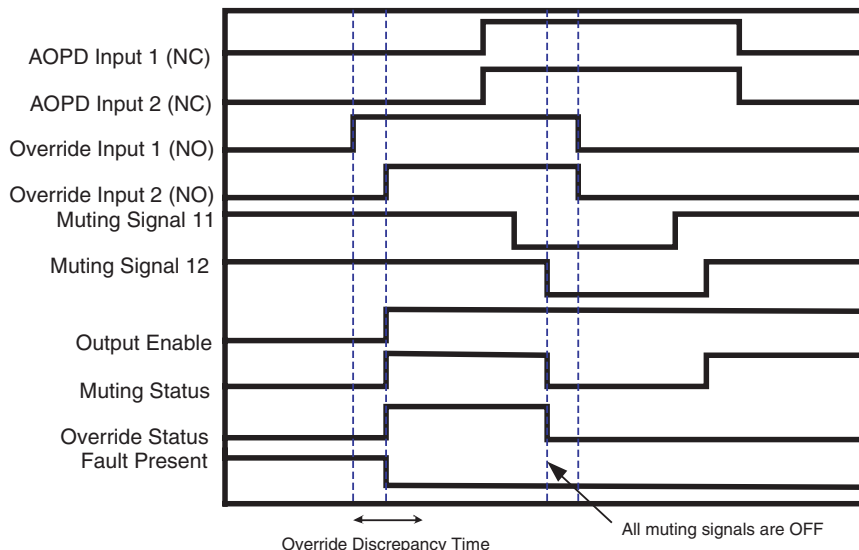

3-5-6 Safety Gate Monitoring

Basic Function

Monitors the status of a safety gate (i.e., a safety door switch or safety limit switch). Function tests can be set for Safety Category 2.

Diagram

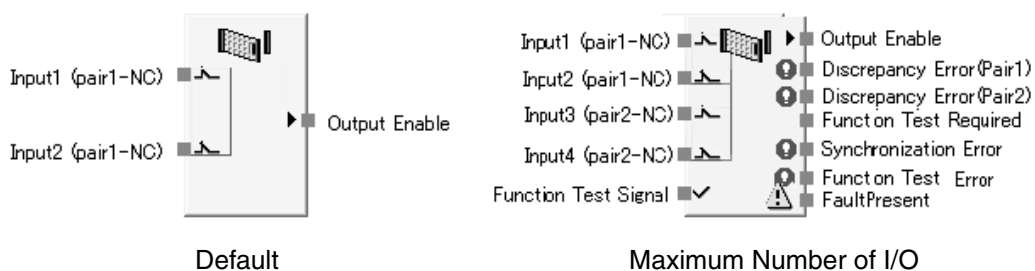

General Description

The Safety Gate Monitoring function block monitors the status of a safety gate. Safety gate status is monitored using an input signal from a safety door switch or safety limit switch connected to the door.

The Output Enable signal will turn ON if the input from the switch being monitored is active. The Output Enable signal will turn OFF if the input is inactive or if an error is detected for the function block.

Startup

All errors are turned OFF and all timers are reset at the start of operation. Outputs are turned ON or OFF according to the input status.

Refer to information later in this section if the function test has been enabled.

Set Parameters

Parameter	Setting range	Default setting
Input Type	Single Channel Dual Channel Equivalent (1 pair) Dual Channel Complementary (1 pair) Two Dual Channel Equivalent (2 pairs) Two Dual Channel Complementary (2 pairs)	Dual Channel Equivalent (1 pair)
Function Test	No Function Test/Function Test Required	No function test
Discrepancy Time Pair 1	0 to 30 s in 10-ms increments A discrepancy time check will not be performed if 0 is set.	30 ms
Discrepancy Time Pair 2		
Synchronization Time	0 to 30 s in 10-ms increments A synchronization time check will not be performed if 0 is set.	300 ms

The timer SV must be longer than the cycle time.

Optional Output Settings

The following outputs can also be used in programming. To enable any of these optional outputs, select the check box on the Output Point Tab Page of the function block properties dialog box.

- Discrepancy Error Pair 1
- Discrepancy Error Pair 2
- Function Test Required Signal
- Synchronization Error
- Function Test Error

Fault Present Output Setting

Fault Present output can also be used in programming. To enable this output, select the Fault Present check box on the Output Point Tab Page of the function block properties dialog box.

Truth Tables

Setting: Single Channel

Input 1 (pair 1-NC)	Output Enable
0	0
1	1

0: OFF, 1: ON

Setting: Dual Channel Equivalent (1 Pair)

Input 1 (pair 1-NC)	Input 2 (pair 1-NC)	Output Enable
0	0	0
0	1	0
1	0	0
1	1	1

0: OFF, 1: ON

Setting: Dual Channel Complementary (1 Pair)

Input 1 (pair 1-NC)	Input 2 (pair 1-NO)	Output Enable
0	0	0
0	1	0
1	0	1
1	1	0

0: OFF, 1: ON

Setting: Two Dual Channel Equivalent (2 Pairs)

Input 1 (pair 1-NC)	Input 2 (pair 1-NC)	Input 3 (pair 2-NC)	Input 4 (pair 2-NC)	Output Enable
0	0	0	0	0
0	0	0	1	0
0	0	1	0	0
0	0	1	1	0
0	1	0	0	0
0	1	0	1	0
0	1	1	0	0
0	1	1	1	0
1	0	0	0	0
1	0	0	1	0
1	0	1	0	0
1	0	1	1	0
1	1	0	0	0
1	1	0	1	0
1	1	1	0	0
1	1	1	1	1

0: OFF, 1: ON

Setting: Two Dual Channel Complementary (2 Pairs)

Input 1 (pair 1-NC)	Input 2 (pair 1-NO)	Input 3 (pair 2-NC)	Input 4 (pair 2-NO)	Output Enable
0	0	0	0	0
0	0	0	1	0
0	0	1	0	0
0	0	1	1	0
0	1	0	0	0
0	1	0	1	0
0	1	1	0	0
0	1	1	1	0
1	0	0	0	0
1	0	0	1	0
1	0	1	0	1
1	0	1	1	0
1	1	0	0	0
1	1	0	1	0
1	1	1	0	0
1	1	1	1	0

0: OFF, 1: ON

Error Handling and Error Resetting

Error condition	Behavior for error detection			Resetting the error condition
	Output Enable	Fault Present	Error output	
Discrepancy error at pair 1	OFF (safety state)	ON	Discrepancy Error Pair 1: ON	1. Function Test Disabled Remove the cause of the error and then make the inputs inactive and then active again (See note.) or change the G9SP-series Controller's operating mode to IDLE Mode and then back to RUN Mode. 2. Function Test Required If Function Test Required is active: Remove the cause of the error and then make the inputs active, inactive, and then active again (i.e., perform the safety gate test). If Function Test Required is inactive: Remove the cause of the error and then make the inputs in active and then active again.
Discrepancy error at pair 2			Discrepancy Error Pair 2: ON	
Function test error Safety gate test was not performed normally between Function Test signals.			Function Test Error: ON	
Synchronization Error (error detected in synchronization time evaluation between input pair 1 an input pair 2)			Synchronization Test Error: ON	

Note If a discrepancy error occurs in one of the pairs when set to Dual Channel Equivalent (2 pairs) or Dual Channel Complementary (2 pairs), make input pairs 1 and 2 both inactive and then active to reset the error. Errors that occur independently will be output even if they occur chronologically. (If there is a discrepancy error for input pair 1, input pair 1 will still be evaluated and then the synchronization time with input pair 2 will be evaluated.)

Function Tests

For some safety gate applications, safeguarding devices require physical verification that the device continues to operate properly (e.g., required for Category 2 safety gate applications).

If the function test is enabled for the Safety Gate Monitoring function block, a safety gate test in which the safety gate must be opened and then closed again can be added as a condition for turning ON the Output Enable signal.

If enabled, the safety gate test must be executed under the following conditions.

1. Startup
The safety gate test must be executed when the G9SP-series Controller is started (i.e., when the Controller's operating mode changes from IDLE Mode to RUN Mode). If the test ends normally, the Output Enable signal will turn ON.
2. Function Test Request from the Machine
The safety gate test must be executed after the G9SP-series Controller detects that the Function Test Signal from the machine turns ON and before the Function Test Signal turns ON again. If the Function Test Signal turns ON a second time before the safety gate test is completed normally, a function test error will occur, the Output Enable signal will turn OFF, and the Function Test Error signal will turn ON.
3. Error Detected in Safety Gate Monitoring Function Block
The safety gate test must be executed if a function test error, discrepancy error, or other function block error occurs (after removing the cause of the error).

The Function Test Required Signal from the Safety Gate Monitoring function block will turn ON when a safety gate test is required and it will remain ON until the safety gate test has been completed normally.

If a safety gate test ends and a function test request occur in the same cycle when there is a request for a function test, the function test will be given priority and a function test error will occur.

The safety gate must be closed (ON), opened (OFF), and then closed again for the safety gate test. If the gate is closed when the test is started, the test will end when the gate is opened and then closed. If there are two pairs of inputs, the test will end when both input pair 1 and input pair 2 turn ON, OFF, and then ON again independently (without synchronization).

Timing Charts

Single Channel, Function Test Set to Enabled

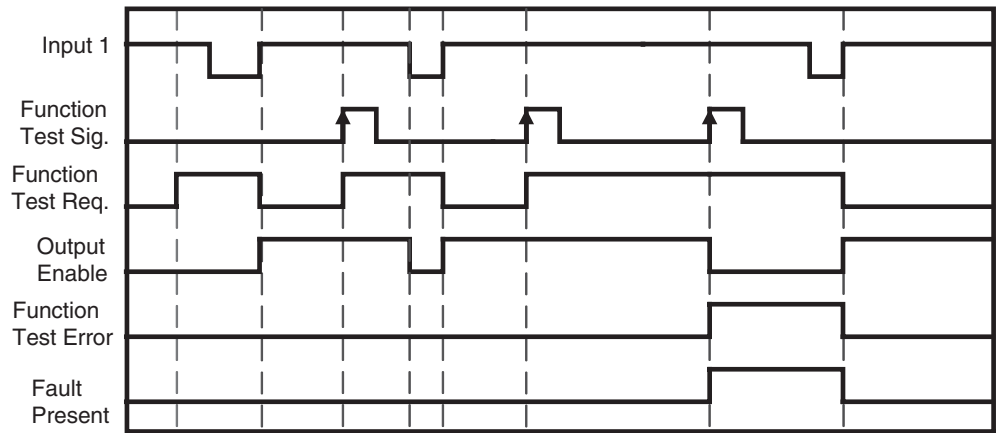

IDLE to RUN

Dual Channel Equivalent, Function Test Set to Disabled

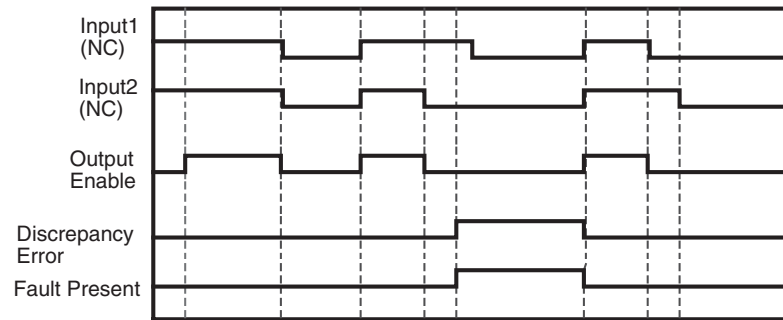

IDLE to RUN

Discrepancy time

Discrepancy time

Dual Channel Equivalent (2 pairs), Function Test Set to Disabled

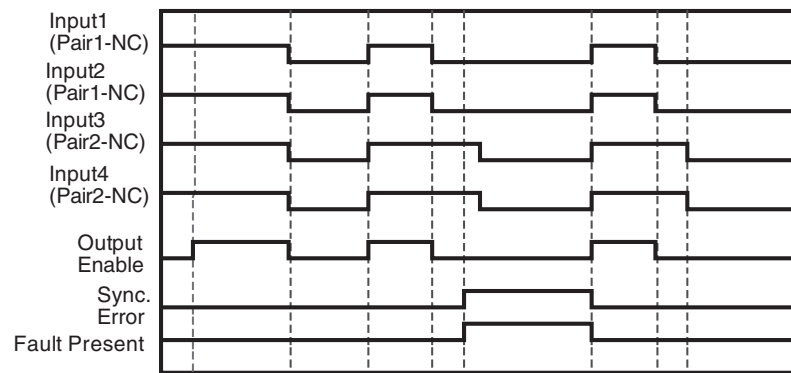

IDLE to RUN

Synchronization time

Synchronization time

3-5-7 Two-hand Control

Basic Function

The Two-hand Control function block enables monitoring the status of a two-hand switch.

Diagram

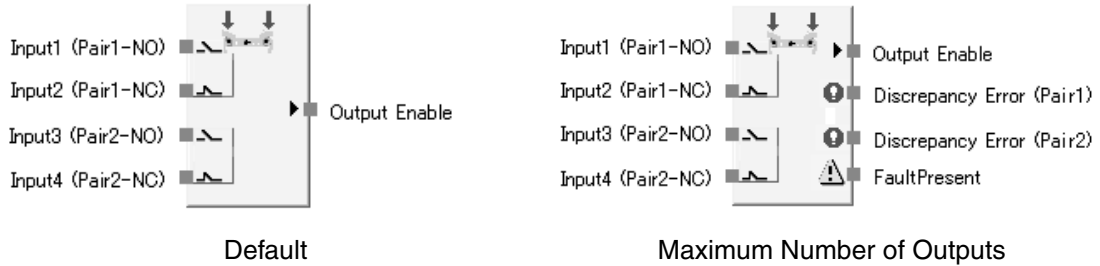

General Description

The Two-hand Control function block enables monitoring the status of a two-hand switch.

The Two-hand Control function block can be used with a suitable 2-hand switch to meet the requirements of type III C in ISO 13851, *Safety of machinery - Two-hand control devices - Principles for design and selection*. The Output Enable signal will turn ON only if both inputs from the two-hand switch are active and satisfy the requirements of ISO 13851. The Output Enable signal will turn OFF if the inputs from the two-hand switch do not satisfy the requirements of ISO 13851, an input is inactive, or if an error is detected for the function block.

Startup

All errors are turned OFF and all timers are reset at the start of operation. The Output Enable signal will turn OFF even if the evaluation for both input pair 1 and input pair 2 is “active.” The output condition must be satisfied before the Output Enable signal will turn ON.

Set Parameters

Parameter	Setting range	Default setting
Discrepancy Time Pair 1	0 to 500 ms in 10-ms increments A discrepancy time check will not be performed if 0 is set.	30 ms
Discrepancy Time Pair 2		

The timer SV must be longer than the G9SP-series Controller's cycle time.

Optional Output Settings

The following error outputs can also be used in programming. To enable either of these optional outputs, select the check box on the Output Point Tab Page of the function block properties dialog box.

- Discrepancy Error Pair 1
- Discrepancy Error Pair 2

Fault Present Output Setting

Fault Present output can also be used in programming. To enable this output, select the Use Fault Present check box on the Output Point Tab Page of the function block properties dialog box.

Truth Table

Truth Table for Two-hand Control

Input 1 (Pair 1-NO)	Input 2 (Pair 1-NC)	Input 3 (Pair 2-NO)	Input 4 (Pair 2-NC)	Output Enable
0	0	0	0	0
0	0	0	1	0
0	0	1	0	0
0	0	1	1	0
0	1	0	0	0
0	1	0	1	0
0	1	1	0	0
0	1	1	1	0
1	0	0	0	0
1	0	0	1	0
1	0	1	0	1
1	0	1	1	0
1	1	0	0	0
1	1	0	1	0
1	1	1	0	0
1	1	1	1	0

0: OFF, 1: ON

Error Handling and Error Resetting

Error condition	Behavior for error detection			Resetting the error condition
	Output Enable	Fault Present	Error output	
Discrepancy Error at Pair 1	OFF (safety state)	ON	Discrepancy Error Pair 1: ON	Remove the cause of the error and then do the following: 1. Make the both input pair 1 and pair 2 inactive and then active again. 2. Or change the G9SP-series Controller's operating mode to IDLE Mode and then back to RUN Mode.
Discrepancy Error at Pair 2			Discrepancy Error Pair 2: ON	

Note The Output Enable signal will not turn ON if the synchronization time requirement is not satisfied (i.e., operation inputs for both hands must be completed within 500 ms), but this is **not** considered an error.

Timing Chart

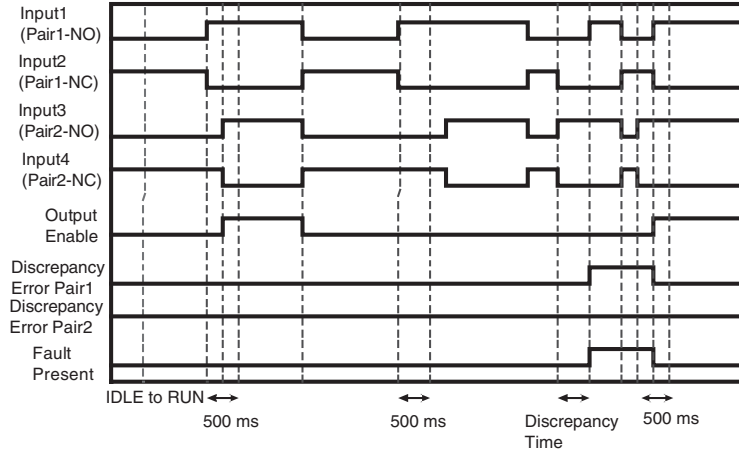

3-5-8 User Mode Switch

Basic Function

The User Mode Switch function block is used to monitor an operating mode switch in the user system or device.

Diagram

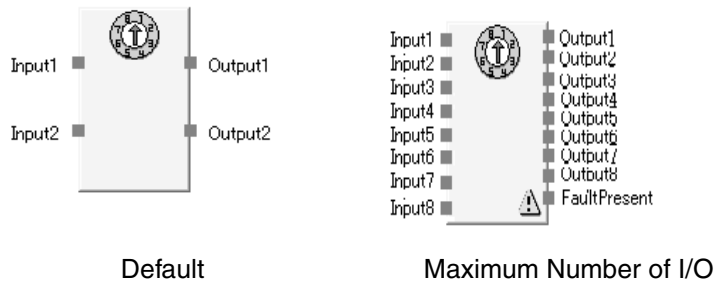

General Description

The User Mode Switch function block is used to monitor an operating mode switch in the user system or device.

The operating mode switch that can be connected with this function block must be a 1-of-N type switch (i.e., one of N contacts is ON). The function block supports a maximum of eight inputs and corresponding outputs.

The output corresponding to the input that is active is turned ON. If an error is detected for the function block, however, all outputs will turn OFF.

Startup

All errors are turned OFF and all timers are reset at the start of operation. Outputs are turned ON or OFF according to the input status.

Optional Output Settings

The number of I/O can be increased on the In/Out Setting Tab Page in the function block property dialog box.

Parameter	Setting range	Default setting
Number of inputs	2 to 8	2
Number of outputs	2 to 8	2

The number of inputs and the number of outputs will be the same.

Fault Present Output Setting

Fault Present output can also be used in programming. To enable this output, select the Fault Present check box on the In/Out Setting Tab Page of the function block properties dialog box.

Truth Table

Truth Table for User Mode Monitoring

Inputs								Outputs							
1	2	3	4	5	6	7	8	1	2	3	4	5	6	7	8
1	0	0	0	0	0	0	0	1	0	0	0	0	0	0	0
0	1	0	0	0	0	0	0	0	1	0	0	0	0	0	0
0	0	1	0	0	0	0	0	0	0	1	0	0	0	0	0
0	0	0	1	0	0	0	0	0	0	0	1	0	0	0	0
0	0	0	0	1	0	0	0	0	0	0	0	1	0	0	0
0	0	0	0	0	1	0	0	0	0	0	0	0	1	0	0
0	0	0	0	0	0	1	0	0	0	0	0	0	0	1	0
0	0	0	0	0	0	0	1	0	0	0	0	0	0	0	1

0: OFF, 1: ON

Error Handling and Error Resetting

Error condition	Behavior for error detection		Resetting the error condition
	Output	Fault Present	
More than one input was ON for more than 2 s	OFF (safety state)	ON	Remove the cause of the error. (Correct system so that only 1 contact is ON.)
All inputs were OFF for more than 2 s			

Note to the first input to turn ON will turn ON for 2 s. If more than one input turns ON in the same G9SP-series Controller cycle, then all outputs will turn OFF.

Timing Chart

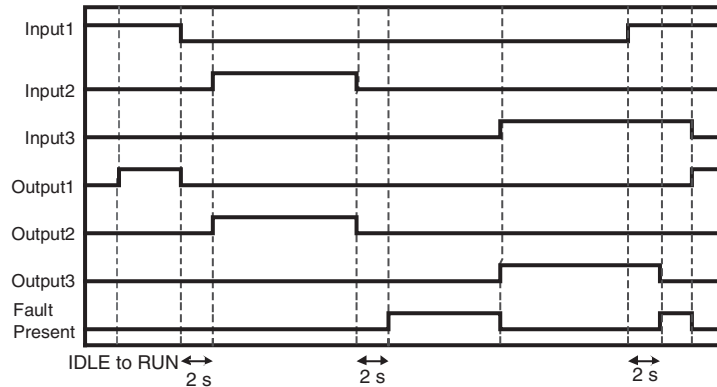

3-5-9 Redundant Input

Basic Function Generic function block for two-input signal monitoring.

Diagram

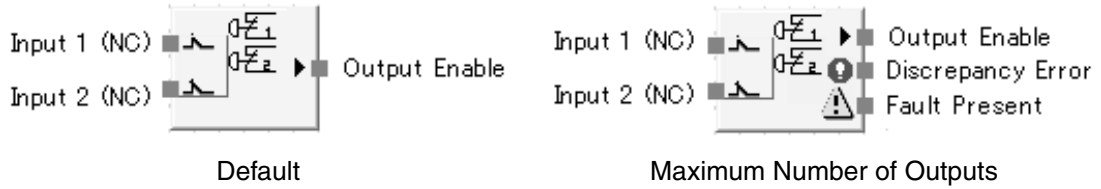

General Description

The Generic Two-input function block can be used for general-purpose monitoring of safety two-input sensors and switches.

The Enable Output signal turns ON when a monitored sensor or switch is activated, and it turns OFF when they are not active or when an error is detected in the function block.

This function block and the set parameters are equivalent to those of the Emergency Stop Switch Monitoring function block.

For details, refer to 3-5-3 Emergency Stop Pushbutton Monitoring (E-Stop).

3-5-10 Single Beam Safety Sensor Monitoring

Basic Function

The Single Beam Safety Sensor function block monitors the input signal of an OMRON E3ZS/E3FS Single-beam Safety Sensor.

Diagram

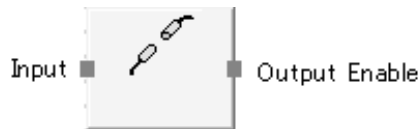

General Description

The Single-beam Safety Sensor function block is used to monitor a single-beam safety sensor. If the input from the single-beam safety sensor that is being monitored is active, the Output Enable signal will turn ON. If the input is not active or an error is detected (e.g., a short-circuit), the Output Enable signal will turn OFF.

Set Parameters

There are no set parameters.

Timing Chart

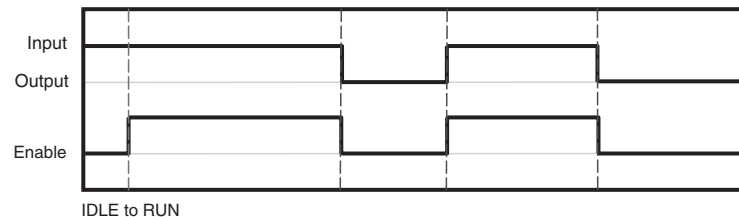

3-5-11 Non-Contact Door Switch

Basic Function

The Non-Contact Door Switch function block monitors the status of an OMRON D40A or D40Z Non-contact Door Switch.

Diagram

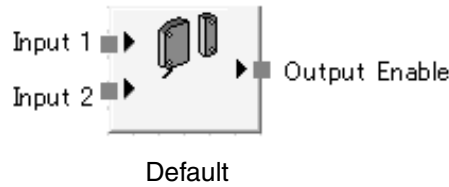

General Description

The OMRON D40A or D40Z Non-contact Switch performs diagnosis using the safety input terminals, and so the value is input to the function block after evaluation. Therefore, the Non-contact Door Switch Monitoring function block judges whether the values for Input 1 and Input 2 are the same. In other words, operation is the same as for the AND function block.

Truth Table

Input 1 (NC)	Input 2 (NC)	Output Enable
0	0	0
0	1	0
1	0	0
1	1	1

O: OFF, 1: ON

3-5-12 Safety Mat

Basic Function

The Safety Mat function Switch function block monitors the status of an OMRON UM Safety Mat.

Diagram

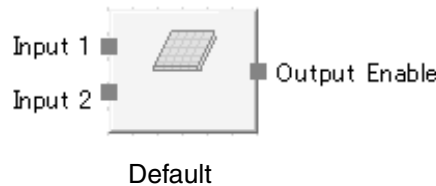

General Description

The OMRON UM Safety Mat performs diagnosis using the safety input terminals, and so the value is input to the function block after evaluation. Therefore, the Safety Mat Monitoring function block judges whether the values for Input 1 and Input 2 are the same. In other words, operation is the same as for the AND function block.

Truth Table

Input 1 (NO)	Input 2 (NO)	Output Enable
0	0	0
0	1	0
1	0	0
1	1	1

O: OFF, 1: ON

3-6 Reset and Restart Function Blocks

Section	Function Blocks		Support		Page	Compatible unit versions
	Notation in function list	Name	G9SP	NE1A		
3-6-1	Reset	Reset	○	○	76	
3-6-2	Restart	Restart	○	○	78	

×: No, ○: Yes

3-6-1 Reset

Basic Function

The Reset function block outputs ON if the reset signal is correctly input while the input signal is ON. This function block can be used to prevent equipment from starting automatically.

Diagram

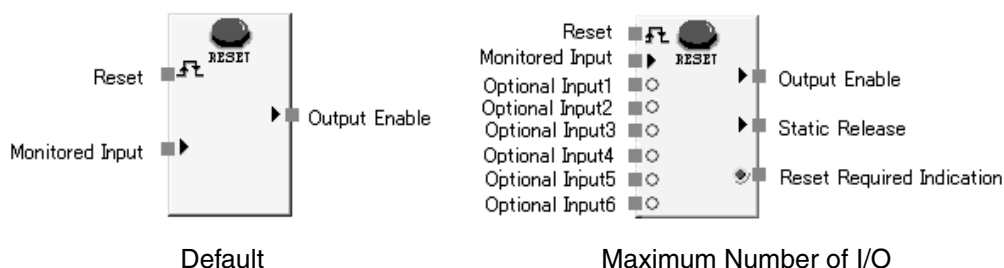

General Description

The Output Enable signal is turned ON when the Reset signal is correctly input while Monitored Input and Optional Input are ON for the Reset function block.

This function block can be used to prevent the machine from automatically resetting, e.g., when the power to the G9SP-series Controller is turned ON, when the operating mode is changed from IDLE Mode to RUN Mode, or when a signal from a safety input device turns ON.

Conditions for Output Enable Turning ON

- The Monitored Input and all enabled optional inputs must be ON. And the Reset signal must be input correctly.

Conditions for Static Release Turning ON

The Monitored Input and all enabled optional inputs must be ON.

Conditions for Reset Required Indication Turning ON

If the following condition is satisfied, the Reset Required Indication will become a 1-Hz pulse output.

- The Monitored Input and all enabled optional inputs must be ON.
- And Output Enable must be OFF.

If the Reset Signal is set to Low-High-Low, the Reset Required Indication will turn ON when the next condition is satisfied.

- The Reset signal turns ON.

Startup

All errors are turned OFF and all timers are reset at the start of operation.

Set Parameters

The Reset signal can be set.

Parameter	Setting range	Default setting
Reset Signal	<ul style="list-style-type: none"> • Low-High-Low • Rising Edge 	Low-High-Low

Low-High-Low

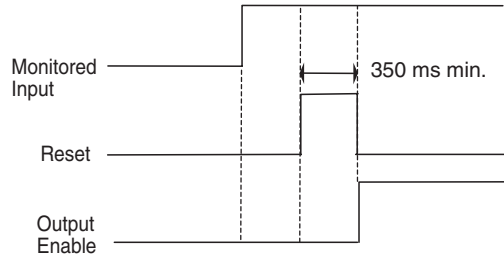

The reset input must turn OFF after 350 ms or longer has elapsed from when the reset signal turns from OFF to ON once the Monitored Input and all enabled Optional Inputs turn ON. (Resetting is disabled if the Reset signal turns ON in the same cycle as the cycle in which the Monitored Input and enabled Optional Input turn ON. Resetting is enabled if the signal turns OFF in the same cycle and ON in the next cycle, and reset will be performed if the conditions are satisfied.)

Rising Edge

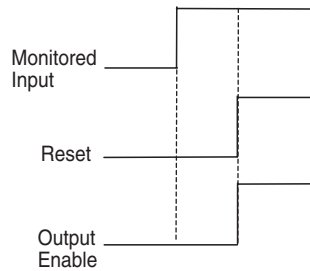

The Reset input signal must change from OFF to ON after the Monitored Input and all enabled Optional Inputs turn ON. (Resetting is disabled if the Reset signal turns ON in the same cycle as the cycle in which the Monitored Input and enabled Optional Input turn ON. Resetting is enabled if the signal turns OFF in the same cycle and ON in the next cycle, and reset will be performed.)

Number of Inputs Setting

The number of inputs can be increased on the In/Out Setting Tab Page in the function block property dialog box.

Parameter	Setting range	Default setting
Number of inputs	2 to 8 (Optional Input Settings)	2

Optional Output Settings

The outputs shown below can be used in the program. To enable either of these outputs, select the check box on the Output Point Tab Page of the function block properties dialog box.

- Static Release
- Reset Required Indication

Timing Chart

Reset Signal set to Low-High-Low:

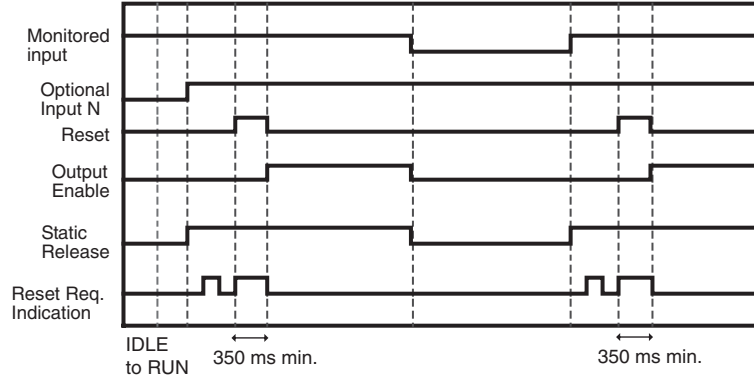

Reset Signal set to Rising Edge:

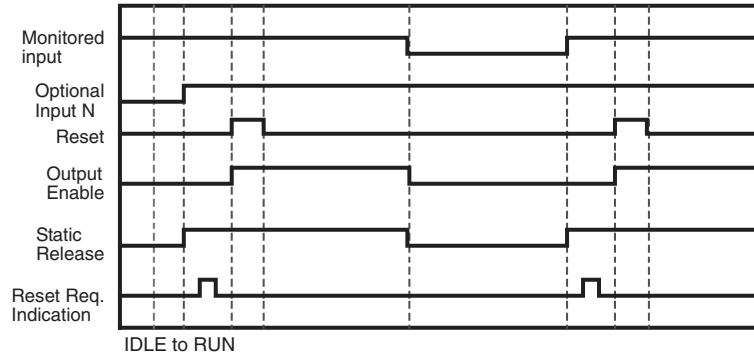

Precautions for Correct Use

When the Reset signal is set to the rising edge, noise or other instantaneous pulse signals may cause resetting and machinery or equipment to start operation due to the Output Enable signal turning ON. Therefore, using the Low-High-Low setting is recommended.

3-6-2 Restart

Basic Function

The Restart function block performs the same operation as a Reset function block. The icon is different.

Refer to 3-6-1 *Reset* for a description of functions and setting parameters.

Diagram

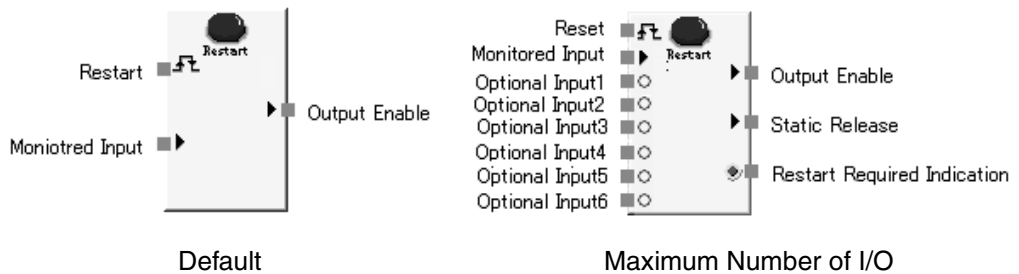

3-7 Connector Function Blocks

Section	Function Blocks		Support		Page	Compatible unit versions
	Notation in function list	Name	G9SP	NE1A		
3-7-1	Multi Connector	Multi Connector	○	○	79	NE1A-series Controllers with unit version 1.0 or later
3-7-2	Routing	Routing	○	○	80	

×: No, ○: Yes

3-7-1 Multi Connector

Basic Function

The Multi Connector function block outputs the status of the input signals.

Diagram

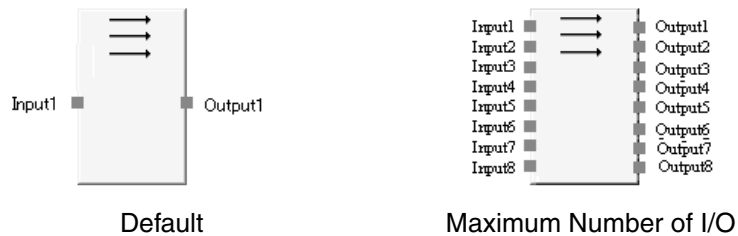

General Description

The Multi Connector function block outputs input signals (up to 8 inputs) to output signals (up to 8 outputs).

The input signals and output signals are associated one-to-one from number 1 to 8. The status of other input signals have no effect.

With an G9SP-series Controller, it is not possible to make a direct connection from an input tag signal to an output tag. To do so, connect the signal by using a Multi Connector function block.

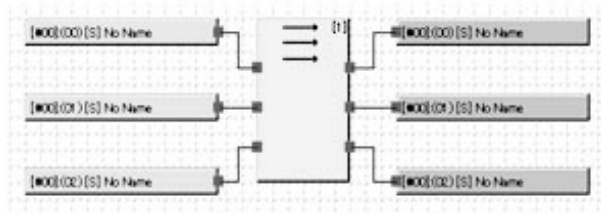
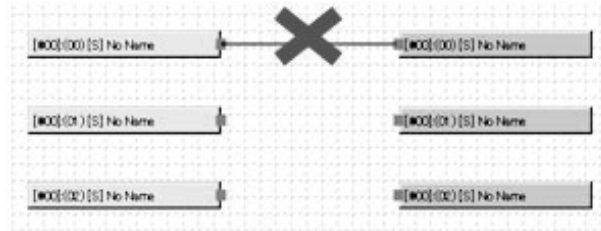

Optional Output Settings

The number of outputs can be increased on the In/Out Setting Tab Page in the function block property dialog box.

Parameter	Setting range	Default setting
Number of I/O	1 to 8	1

3-7-2 Routing

Basic Function

Used for routing an input signal to multiple signals.

Diagram

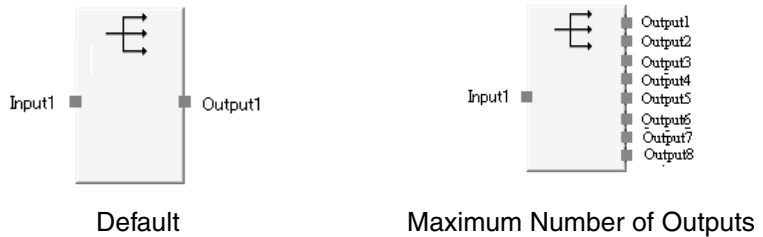

General Description

The Routing function block routes one input signal to a maximum of eight output signals. It is used to output a signal to more than one output tag. With an G9SP-series Controller, it is not possible to make a direct connection from one signal to two output tags. To do so, distribute the signal by using a Routing function block.

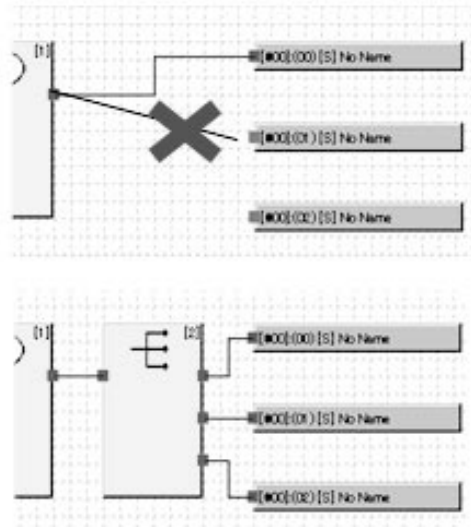

Optional Output Settings

The number of outputs can be increased on the In/Out Setting Tab Page in the function block property dialog box.

Parameter	Setting range	Default setting
Number of outputs	1 to 8	1

Truth Table

Truth Table for Routing Evaluation

Input 1	Output 1	Output 2	Output 3	Output 4	Output 5	Output 6	Output 7	Output 8
0	0	0	0	0	0	0	0	0
1	1	1	1	1	1	1	1	1

0: OFF, 1: ON

Index

A

AND, 19
Auto Reset, 37

C

comments, 6
Comparator, 30
Comparator2, 32
connector function blocks, 10
Counter, 36

D

discrepancy error, 18
discrepancy time, 15
dual channel, 12

E

EDM, 43
Emergency Stop Pushbutton Monitoring, 47
Enable Switch, 44
Enable Switch Monitoring, 44
E-Stop, 47
example for dual channel equivalent setting, 16
Exclusive NOR, 28
Exclusive OR, 28
EXNOR, 28
EXOR, 28
External Device Monitoring, 43

F

Fault Present, 6
function blocks, 2, 8, 11
function tests, 68

I

input and output size settings, 5
input tags, 2
input type settings, 13

L

Light Curtain Monitoring, 48
logic functions, 8

M

manual reset function, 47
Multi Connector, 79
Muting, 50

N

NAND, 24
Non-Contact Door Switch, 74
NOR, 26
NOT, 19

O

OFF-delay timer, 34
ON-delay timer, 34
operation at startup, 13
operation example for dual channel equivalent setting, 16
OR, 22
output points setting, 5
output tags, 3
override function, 52, 64

P

Parallel Muting with Two Sensors, 55
Position Detection, 62
Pulse Generator, 35

R

Redundant Input, 74
reset, 76
reset and restart function blocks, 10
reset condition, 5
Reset Set Flip-Flop, 29
restart, 78
routing, 80
RS-FF, 29

S

safety device function blocks, 9
safety gate, 65
Safety Gate Monitoring, 65
Safety Mat, 75
Sequential Muting in Both Directions, 60
Sequential Muting in Forward Direction, 58
Serial-Parallel Converter, 40
setting
 dual channel complementary, 14
 dual channel complementary (2 pairs), 15
 dual channel equivalent, 14
 dual channel equivalent (2 pairs), 14
 single channel, 14
Single Beam Safety Sensor Monitoring, 74

T

timer operation conditions for discrepancy time, 17
Timer/Counter Function Blocks, 34
timer/counter functions, 9
Two-hand Control, 70
two-hand control, 74
two-input signal monitoring, 74

U

Up-Down Counter, 38
User Mode Switch, 72

Revision History

A manual revision code appears as a suffix to the catalog number on the front cover of the manual.

Cat. No. Z923-E1-04



Revision code

The following table outlines the changes made to the manual during each revision. Page numbers refer to the previous version.

Revision code	Date	Revised content
01	June 2010	Original production
02	September 2010	Added D40Z No-contact Switch, added descriptions, and corrected mistakes.
03	June 2014	Corrected mistakes and added descriptions.
04	June 2023	Made changes accompanying revision to the standards.

Revision History

OMRON Corporation Industrial Automation Company

Kyoto, JAPAN

Contact : www.ia.omron.com

Regional Headquarters

OMRON EUROPE B.V.

Wegalaan 67-69, 2132 JD Hoofddorp
The Netherlands
Tel: (31) 2356-81-300 Fax: (31) 2356-81-388

OMRON ASIA PACIFIC PTE. LTD.

438B Alexandra Road, #08-01/02 Alexandra
Technopark, Singapore 119968
Tel: (65) 6835-3011 Fax: (65) 6835-3011

OMRON ELECTRONICS LLC

2895 Greenspoint Parkway, Suite 200
Hoffman Estates, IL 60169 U.S.A.
Tel: (1) 847-843-7900 Fax: (1) 847-843-7787

OMRON (CHINA) CO., LTD.

Room 2211, Bank of China Tower,
200 Yin Cheng Zhong Road,
PuDong New Area, Shanghai, 200120, China
Tel: (86) 21-6023-0333 Fax: (86) 21-5037-2388

Authorized Distributor:

©OMRON Corporation 2010-2023 All Rights Reserved.
In the interest of product improvement,
specifications are subject to change without notice.

Printed in Japan

Cat. No. Z923-E1-04 0623