

NJ/NX/NY-series Controller

# Startup Guide for Simulink® & Sysmac Studio

SYSMAC-SE20□□

NX701-□□□□

NX1P2-□□□□

NJ501-□□□□

NJ301-□□□□

NJ101-□□□□

NY532-□□□□

NY512-□□□□

R88D-KN□-ECT

R88D-1SN□-ECT

GX-AD0471/DA0271

NX-AD□□□□

NX-DA□□□□

NA5-□W□□□□

NA5-□□W□□□□



Startup  
Guide

©OMRON, 2013 - 2017

All rights reserved. No part of this publication may be reproduced, stored in a retrieval system, or transmitted, in any form, or by any means, mechanical, electronic, photocopying, recording, or otherwise, without the prior written permission of OMRON.

No patent liability is assumed with respect to the use of the information contained herein. Moreover, because OMRON is constantly striving to improve its high-quality products, the information contained in this manual is subject to change without notice. Every precaution has been taken in the preparation of this manual. Nevertheless, OMRON assumes no responsibility for errors or omissions. Neither is any liability assumed for damages resulting from the use of the information contained in this publication.

# Introduction

The *NJ/NX/NY-series Controller Startup Guide for Simulink® and Sysmac Studio* (hereinafter, may be referred to as “this Guide”) describes the startup procedures that are required to use a combination of Simulink® from The MathWorks® Inc. and the NJ/NX/NY-series Controller for the first time and the basic operating instructions for the Sysmac Studio. A simple single-axis positioning example is used for the discussion. You can perform the procedures that are presented in this Guide to quickly gain a basic understanding of the combination of Simulink® and the NJ/NX/NY-series Controller.

This Guide does not contain safety information and other details that are required for actual use. Thoroughly read and understand the manuals for all of the devices that are used in this Guide to ensure that the system is used safely. Review the entire contents of these materials, including all safety precautions, precautions for safe use, and precautions for correct use.

## Intended Audience

---

This guide is intended for the following personnel.

- Personnel in charge of introducing FA systems
- Personnel in charge of designing FA systems

The personnel must also have the following knowledge.

- Knowledge of electrical systems (an electrical engineer or the equivalent)
- Knowledge of MATLAB®/Simulink® from The MathWorks® Inc.
- Knowledge of the NJ/NX/NY-series Controller
- Knowledge of operation procedure of Sysmac Studio

## Applicable Products

---

This guide covers the following products.

- CPU Units of NJ/NX-series Machine Automation Controllers
- Industrial PC Platform NY-series IPC Machine Controller
- Sysmac Studio Automation Software
- MATLAB®/Simulink® from The MathWorks® Inc.
- Simulink® PLC Coder™ from The MathWorks® Inc.

## Special Information

---

The icons that are used in this Guide are described below.



### Precautions for Correct Use

---

Precautions on what to do and what not to do to ensure proper operation and performance.

---



### Additional Information

---

Additional information to read as required.

This information is provided to increase understanding or make operation easier.

---

# Terms and Conditions Agreement

## NJ/NX/NY-series Controller

### Warranties

(a) Exclusive Warranty. Omron's exclusive warranty is that the Products will be free from defects in materials and workmanship for a period of twelve months from the date of sale by Omron (or such other period expressed in writing by Omron). Omron disclaims all other warranties, express or implied.

(b) Limitations. OMRON MAKES NO WARRANTY OR REPRESENTATION, EXPRESS OR IMPLIED, ABOUT NON-INFRINGEMENT, MERCHANTABILITY OR FITNESS FOR A PARTICULAR PURPOSE OF THE PRODUCTS. BUYER ACKNOWLEDGES THAT IT ALONE HAS DETERMINED THAT THE

PRODUCTS WILL SUITABLY MEET THE REQUIREMENTS OF THEIR INTENDED USE.

Omron further disclaims all warranties and responsibility of any type for claims or expenses based on infringement by the Products or otherwise of any intellectual property right. (c) Buyer Remedy. Omron's sole obligation hereunder shall be, at Omron's election, to (i) replace (in the form originally shipped with Buyer responsible for labor charges for removal or replacement thereof) the non-complying Product, (ii) repair the non-complying Product, or (iii) repay or credit Buyer an amount equal to the purchase price of the non-complying Product; provided that in no event shall Omron be responsible for warranty, repair, indemnity or any other claims or expenses regarding the Products unless Omron's analysis confirms that the Products were properly handled, stored, installed and maintained and not subject to contamination, abuse, misuse or inappropriate modification. Return of any Products by Buyer must be approved in writing by Omron before shipment. Omron Companies shall not be liable for the suitability or unsuitability or the results from the use of Products in combination with any electrical or electronic components, circuits, system assemblies or any other materials or substances or environments. Any advice, recommendations or information given orally or in writing, are not to be construed as an amendment or addition to the above warranty.

See <http://www.omron.com/global/> or contact your Omron representative for published information.

### Limitation on Liability; Etc

OMRON COMPANIES SHALL NOT BE LIABLE FOR SPECIAL, INDIRECT, INCIDENTAL, OR CONSEQUENTIAL DAMAGES, LOSS OF PROFITS OR PRODUCTION OR COMMERCIAL LOSS IN ANY WAY CONNECTED WITH THE PRODUCTS, WHETHER SUCH CLAIM IS BASED IN CONTRACT, WARRANTY, NEGLIGENCE OR STRICT LIABILITY.

Further, in no event shall liability of Omron Companies exceed the individual price of the Product on which liability is asserted.

### Suitability of Use

Omron Companies shall not be responsible for conformity with any standards, codes or regulations which apply to the combination of the Product in the Buyer's application or use of the Product. At Buyer's request, Omron will provide applicable third party certification documents identifying ratings and limitations of use which apply to the Product. This information by itself is not sufficient for a

complete determination of the suitability of the Product in combination with the end product, machine, system, or other application or use. Buyer shall be solely responsible for determining appropriateness of the particular Product with respect to Buyer's application, product or system. Buyer shall take application responsibility in all cases.

NEVER USE THE PRODUCT FOR AN APPLICATION INVOLVING SERIOUS RISK TO LIFE OR PROPERTY WITHOUT ENSURING THAT THE SYSTEM AS A WHOLE HAS BEEN DESIGNED TO ADDRESS THE RISKS, AND THAT THE OMRON PRODUCT(S) IS PROPERLY RATED AND INSTALLED FOR THE INTENDED USE WITHIN THE OVERALL EQUIPMENT OR SYSTEM.

### **Programmable Products**

Omron Companies shall not be responsible for the user's programming of a programmable Product, or any consequence thereof.

### **Performance Data**

Data presented in Omron Company websites, catalogs and other materials is provided as a guide for the user in determining suitability and does not constitute a warranty. It may represent the result of Omron's test conditions, and the user must correlate it to actual application requirements. Actual performance is subject to the Omron's Warranty and Limitations of Liability.

### **Change in Specifications**

Product specifications and accessories may be changed at any time based on improvements and other reasons. It is our practice to change part numbers when published ratings or features are changed, or when significant construction changes are made. However, some specifications of the Product may be changed without any notice. When in doubt, special part numbers may be assigned to fix or establish key specifications for your application. Please consult with your Omron's representative at any time to confirm actual specifications of purchased Product.

### **Errors and Omissions**

Information presented by Omron Companies has been checked and is believed to be accurate; however, no responsibility is assumed for clerical, typographical or proofreading errors or omissions.

### **1. WARRANTY**

(1) The warranty period for the Software is one year from the date of purchase, unless otherwise specifically agreed.

(2) If the User discovers defect of the Software (substantial non-conformity with the manual), and return it to OMRON within the above warranty period, OMRON will replace the Software without charge by offering media or download from OMRON's website. And if the User discovers defect of media which is attributable to OMRON and return it to OMRON within the above warranty period, OMRON will replace defective media without charge. If OMRON is unable to replace defective media or correct the Software, the liability of OMRON and the User's remedy shall be limited to the refund of the license fee paid to OMRON for the Software.

### **2. LIMITATION OF LIABILITY**

(1) THE ABOVE WARRANTY SHALL CONSTITUTE THE USER'S SOLE AND EXCLUSIVE REMEDIES AGAINST OMRON AND THERE ARE NO OTHER WARRANTIES, EXPRESSED OR IMPLIED, INCLUDING BUT NOT LIMITED TO, WARRANTY OF MERCHANTABILITY OR FITNESS FOR PARTICULAR PURPOSE. IN NO EVENT, OMRON WILL BE LIABLE FOR ANY LOST PROFITS OR OTHER INDIRECT, INCIDENTAL, SPECIAL OR CONSEQUENTIAL DAMAGES ARISING OUT OF USE OF THE SOFTWARE.

(2) OMRON SHALL HAVE NO LIABILITY FOR DEFECT OF THE SOFTWARE BASED ON MODIFICATION OR ALTERNATION TO THE SOFTWARE BY THE USER OR ANY THIRD PARTY.

(3) OMRON SHALL HAVE NO LIABILITY FOR SOFTWARE DEVELOPED BY THE USER OR ANY THIRD PARTY BASED ON THE SOFTWARE OR ANY CONSEQUENCE THEREOF.

### **3. APPLICABLE CONDITIONS**

USER SHALL NOT USE THE SOFTWARE FOR THE PURPOSE THAT IS NOT PROVIDED IN THE ATTACHED USER MANUAL.

### **4. CHANGE IN SPECIFICATION**

The software specifications and accessories may be changed at any time based on improvements and other reasons.

### **5. EXTENT OF SERVICE**

The license fee of the Software does not include service costs, such as dispatching technical staff.

### **6. ERRORS AND OMISSIONS**

The information in this manual has been carefully checked and is believed to be accurate; however, no responsibility is assumed for clerical, typographical, or proofreading errors, or omissions.

## Precautions

- When building a system, check the specifications for all devices and equipment that will make up the system and make sure that the OMRON products are used well within their rated specifications and performances. Safety measures, such as safety circuits, must be implemented in order to minimize the risks in the event of a malfunction.
- Thoroughly read and understand the manuals for all devices and equipment that will make up the system to ensure that the system is used safely. Review the entire contents of these manuals, including all safety precautions, precautions for safe use, and precautions for correct use.
- Confirm all regulations, standards, and restrictions that the system must adhere to.
- Contact The MathWorks® Inc. for the codes that were outputted from Simulink® PLC Coder™.
- Applicability of codes that were outputted from Simulink® PLC Coder™ must be judged by the customer.
- Check the user program for proper execution before you use it for actual operation.

## Trademarks

- Sysmac and SYSMAC are trademarks or registered trademarks of OMRON Corporation in Japan and other countries for OMRON factory automation products.
- EtherCAT® is registered trademark and patented technology, licensed by Beckhoff Automation GmbH, Germany.
- MATLAB® and Simulink® are registered trademarks of The MathWorks® Inc.
- Microsoft product screen shot(s) reprinted with permission from Microsoft Corporation.

Other company names and product names in this Guide are the trademarks or registered trademarks of their respective companies.

## Software Licenses and Copyrights

The NJ/NX/NY-series Controller and the Sysmac Studio incorporate certain third party software. The license and copyright information associated with this software is available at [http://www.fa.omron.co.jp/nj\\_info\\_e/](http://www.fa.omron.co.jp/nj_info_e/).

## Related Manuals

The following manuals are related to the NJ/NX/NY-series Controller. Use these manuals for reference.

Manual name	Cat. No.	Model numbers	Application	Description
Sysmac Studio Version 1 Operation Manual	W504	SYSMAC-SE2□□□	Learning about the operating procedures and functions of the Sysmac Studio.	The operating procedures of the Sysmac Studio are described.
NX-series CPU Unit Hardware User's Manual	W535	NX701-□□□□	Learning the basic specifications of the NX-series CPU Units, including introductory information, designing, installation, and maintenance. Mainly hardware information is provided.	Provides an introduction to the entire NX701 system along with the following information on the CPU Unit. <ul style="list-style-type: none"> <li>• Features and system configuration</li> <li>• Introduction</li> <li>• Part names and functions</li> <li>• General specifications</li> <li>• Installation and wiring</li> <li>• Maintenance and inspection</li> </ul>
NX-series NX1P2 CPU Unit Hardware User's Manual	W578	NX1P2-□□□□	Learning the basic specifications of the NX1P2 CPU Units, including introductory information, designing, installation, and maintenance. Mainly hardware information is provided.	Provides an introduction to the entire NX1P2 system along with the following information on the CPU Unit. <ul style="list-style-type: none"> <li>• Features and system configuration</li> <li>• Introduction</li> <li>• Part names and functions</li> <li>• General specifications</li> <li>• Installation and wiring</li> <li>• Maintenance and inspection</li> </ul>
NJ-series CPU Unit Hardware User's Manual	W500	NJ501-□□□□ NJ301-□□□□ NJ101-□□□□	Learning the basic specifications of the NJ-series CPU Units, including introductory information, designing, installation, and maintenance. Mainly hardware information is provided.	Provides an introduction to the entire NJ-series system along with the following information on the CPU Unit. <ul style="list-style-type: none"> <li>• Features and system configuration</li> <li>• Introduction</li> <li>• Part names and functions</li> <li>• General specifications</li> <li>• Installation and wiring</li> <li>• Maintenance and inspection</li> </ul>



Manual name	Cat. No.	Model numbers	Application	Description
NY-series IPC Machine Controller Industrial Panel PC Hardware User's Manual	W557	NY532-□□□□	Learning the basic specifications of the NY-series Industrial Panel PCs, including introductory information, designing, installation, and maintenance.  Mainly hardware information is provided.	An introduction to the entire NY-series system is provided along with the following information on the Industrial Panel PC.  <ul style="list-style-type: none"> <li>• Features and system configuration</li> <li>• Introduction</li> <li>• Part names and functions</li> <li>• General specifications</li> <li>• Installation and wiring</li> <li>• Maintenance and inspection</li> </ul>
NY-series IPC Machine Controller Industrial Box PC Hardware User's Manual	W556	NY512-□□□□	Learning the basic specifications of the NY-series Industrial Box PCs, including introductory information, designing, installation, and maintenance. Mainly hardware information is provided.	An introduction to the entire NY-series system is provided along with the following information on the Industrial Box PC.  <ul style="list-style-type: none"> <li>• Features and system configuration</li> <li>• Introduction</li> <li>• Part names and functions</li> <li>• General specifications</li> <li>• Installation and wiring</li> <li>• Maintenance and inspection</li> </ul>
NY-series IPC Machine Controller Industrial Panel PC / Industrial Box PC Setup User's Manual	W568	NY532-□□□□ NY512-□□□□	Learning the initial settings of the NY-series Industrial PCs and preparations to use Controllers.	The following information is provided on an introduction to the entire NY-series system.  <ul style="list-style-type: none"> <li>• Two OS systems</li> <li>• Initial settings</li> <li>• Industrial PC Support Utility</li> <li>• NYCompolet</li> <li>• Industrial PC API</li> <li>• Backup and recovery</li> </ul>
NJ/NX-series CPU Unit Software User's Manual	W501	NX701-□□□□ NX1P2-□□□□ NJ501-□□□□ NJ301-□□□□ NJ101-□□□□	Learning how to program and set up an NJ/NX-series CPU Unit.  Mainly software information is provided.	Provides the following information on a Controller built with an NJ/NX-series CPU Unit.  <ul style="list-style-type: none"> <li>• CPU Unit operation</li> <li>• CPU Unit features</li> <li>• Initial settings</li> <li>• Language specifications and programming based on IEC 61131-3</li> </ul>
NY-series IPC Machine Controller Industrial Panel PC /Industrial Box PC Software User's Manual	W558	NY532-□□□□ NY512-□□□□	Learning how to program and set up the Controller functions in an NY-series Industrial PC.	The following information is provided on the NY-series Controller functions.  <ul style="list-style-type: none"> <li>• Controller operation</li> <li>• Controller features</li> <li>• Controller settings</li> <li>• Programming based on IEC 61131-3 language specifications</li> </ul>

Manual name	Cat. No.	Model numbers	Application	Description
NJ/NX-series CPU Unit Motion Control User's Manual	W507	NX701-□□□□ NX1P2-□□□□ NJ501-□□□□ NJ301-□□□□ NJ101-□□□□	Learning about motion control settings and programming concepts.	Describes the settings and operation of the CPU Unit and programming concepts for motion control.
NY-series IPC Machine Controller Industrial Panel PC / Industrial Box PC Motion Control User's Manual	W559	NY532-□□□□ NY512-□□□□	Learning about motion control settings and programming concepts of an NY-series Industrial PC.	The settings and operation of the Controller and programming concepts for motion control are described.
NJ/NX-series Instructions Reference Manual	W502	NX701-□□□□ NX1P2-□□□□ NJ501-□□□□ NJ301-□□□□ NJ101-□□□□	Learning detailed specifications on the basic instructions of an NJ/NX-series CPU Unit.	Describes the instructions in the instruction set (IEC 61131-3 specifications).
NY-series Instructions Reference Manual	W560	NY532-□□□□ NY512-□□□□	Learning detailed specifications on the basic instructions of an NY-series Industrial PC.	The instructions in the instruction set (IEC61131-3 specifications) are described.
NJ/NX-series Motion Control Instructions Reference Manual	W508	NX701-□□□□ NX1P2-□□□□ NJ501-□□□□ NJ301-□□□□ NJ101-□□□□	Learning about the specifications of the motion control instructions that are provided by OMRON.	Describes the motion control instructions.
NY-series Motion Control Instructions Reference Manual	W561	NY532-□□□□ NY512-□□□□	Learning about the specifications of the motion control instructions of an NY-series Industrial PC.	The motion control instructions are described.
NJ/NX-series Troubleshooting Manual	W503	NX701-□□□□ NX1P2-□□□□ NJ501-□□□□ NJ301-□□□□ NJ101-□□□□	Learning about the errors that may be detected in an NJ/NX-series Controller.	Describes concepts on managing errors that may be detected in an NJ/NX-series Controller and information on individual errors.
NY-series Troubleshooting Manual	W564	NY532-□□□□ NY512-□□□□	Learning about the errors that may be detected in an NY-series Industrial PC.	Concepts on managing errors that may be detected in an NY-series Controller and information on individual errors are described.
AC Servomotors/Servo Drives G5-series with Built-in EtherCAT Communications User's Manual	I576 I577	R88M-K□ R88D-KN□-ECT R88L-EC-□ R88D-KN□-ECT-L	Learning how to use the AC Servomotors/Servo Drives with built-in EtherCAT Communications.	Describes the hardware, setup methods and functions of the AC Servomotors/Servo Drives with built-in EtherCAT Communications. The linear motor type model and the model dedicated for position controls are available in G5-series.

Manual name	Cat. No.	Model numbers	Application	Description
AC Servomotors/Servo Drives 1S-series with Built-in EtherCAT Communications User's Manual	I586	R88M-1□ R88D-1SN□-ECT	Learning how to use the AC Servomotors/Servo Drives with built-in EtherCAT Communications.	Describes the hardware, setup methods and functions of the AC Servomotors/Servo Drives with built-in EtherCAT Communications.
GX-series EtherCAT Slave Units User's Manual	W488	GX-ID□□□□ GX-OD□□□□ GX-OC□□□□ GX-MD□□□□ GX-AD□□□□ GX-DA□□□□ GX-EC□□□□ XWT-ID□□ XWT-OD□□	Learning how to use the EtherCAT remote I/O terminals.	Describes the hardware, setup methods and functions of the EtherCAT remote I/O terminals.
NX-series EtherCAT Coupler Unit User's Manual	W519	NX-ECC□□□	Learning how to use an NX-series EtherCAT Coupler Unit and EtherCAT Slave Terminals	The system and configuration of EtherCAT Slave Terminals, which consist of an NX-series EtherCAT Coupler Unit and NX Units, are described along with the hardware, setup, and functions of the EtherCAT Coupler Unit that are required to configure, control, and monitor NX Units through EtherCAT.
NX-series NX Units User's Manual	W522	NX-AD□□□□ NX-DA□□□□	Learning how to use NX Units	Describes the hardware, setup methods, and functions of the NX Units. Manuals are available for the following Units. Digital I/O Units, Analog I/O Units, System Units, Position Interface Units, Communications Interface Units, Load Cell Input Units, and IOLink Master Units.
NA-series Programmable Terminal Hardware User's Manual	V117	NA5-□W□□□□ NA5-□□W□□□□	Learning the specifications and settings required to install an NA-series PT and connect peripheral devices.	Information is provided on NA-series PT specifications, part names, installation procedures, and procedures to connect an NA Unit to peripheral devices. Information is also provided on maintenance after operation and troubleshooting.
NA-series Programmable Terminal Software User's Manual	V118	NA5-□W□□□□ NA5-□□W□□□□	Learning about NA-series PT pages and object functions.	NA-series PT pages and object functions are described.

Manual name	Cat. No.	Model numbers	Application	Description
NA-series Programmable Terminal Device Connection User's Manual	V119	NA5-□W□□□□ NA5-□□W□□□□	Learning the specifications required to connect devices to an NA-series PT.	Information is provided on connection procedures and setting procedures to connect an NA-series PT to a Controller or other device.
NA-series Programmable Terminal Startup Guide	V120	NA5-□W□□□□ NA5-□□W□□□□	Learning in concrete terms information required to install and start the operation of an NA-series PT.	The part names and installation procedures are described followed by page creation and transfer procedures with the Sysmac Studio. Also operation, maintenance, and inspection procedures after the project is transferred are described. Sample screen captures are provided as examples.

## Revision History

A manual revision code appears as a suffix to the catalog number on the front and back covers of the manual.

<b>Cat. No.</b>	<b>W529-E1-05</b>
-----------------	-------------------

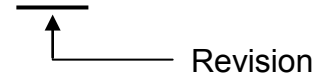
 Revision

Revision code	Date	Revised content
01	June 2013	Original production
02	January 2014	Revisions for adding the SILS (Software In the Loop Simulation) function.
03	January 2015	Revisions for adding the Sysmac IO Device simulation function and the Controller-to-Simulink data acquisition function.
04	June 2016	Revisions for adding AC Servomotors/Servo Drives 1S-Series with Built-in EtherCAT Communications
05	March 2017	Revisions for adding simulation target functions of Servo Drives (1S-series)

# CONTENTS

<b>Introduction</b> .....	<b>1</b>
Intended Audience .....	1
Applicable Products .....	1
Special Information .....	1
<b>Terms and Conditions Agreement</b> .....	<b>2</b>
NJ/NX/NY-series Controller .....	2
Sysmac Studio Automation Software .....	4
<b>Precautions</b> .....	<b>5</b>
Trademarks.....	5
Software Licenses and Copyrights .....	5
<b>Related Manuals</b> .....	<b>6</b>
<b>Revision History</b> .....	<b>11</b>
<b>1. System to Construct and Configuration Devices</b> .....	<b>13</b>
1.1. System Configuration and Configuration Devices .....	13
1.2. The Servo System Constructed in this Guide.....	15
1.3. Sample File List.....	16
<b>2. Before You Begin</b> .....	<b>17</b>
2.1. Wiring the Devices and Installing the Software .....	17
2.2. Designing the Control Algorithm .....	19
<b>3. Setting up the System</b> .....	<b>21</b>
3.1. System Setup Procedures .....	21
3.2. Simulink PLC Coder & Sysmac Studio Operation Procedure .....	23
3.2.1. Outputting the Code using the Simulink PLC Coder.....	23
3.2.2. Importing the Code into the Sysmac Studio.....	25
3.2.3. Checking the Calculation Accuracy .....	27
3.2.4. Creating the EtherCAT Network Configuration .....	29
3.2.5. Setting the Axis .....	30
3.2.6. Creating Programs .....	32
3.2.7. Creating the Programming Terminal Screen .....	35
3.2.8. Preparing the Co-simulation of Simulink and Sysmac Studio.....	36
3.2.9. Debugging by Simulation .....	43
3.2.10. Transferring the Programs to the CPU Unit and Servo Drive .....	47
3.2.11. Transferring Screen Data to Programmable Terminal.....	48
3.2.12. System Operation Check .....	49
<b>4. Appendix</b> .....	<b>56</b>
4.1. Programming in Ladder Diagram Language .....	56
4.2. Sysmac IO Device Support Models and Simulation Target Functions .....	58
(1) Simulation Target Functions of Servo Drives (G5-series).....	58
(2) Simulation Target Functions of Servo Drives (1S-series) .....	60
(3) Simulation Target Functions of Analog Input.....	62
(4) Simulation Target Functions of Analog Output.....	62

# 1. System to Construct and Configuration Devices

## 1.1. System Configuration and Configuration Devices

This section describes the system configuration and configuration devices used in this Guide.

The following figure represents the system configuration.

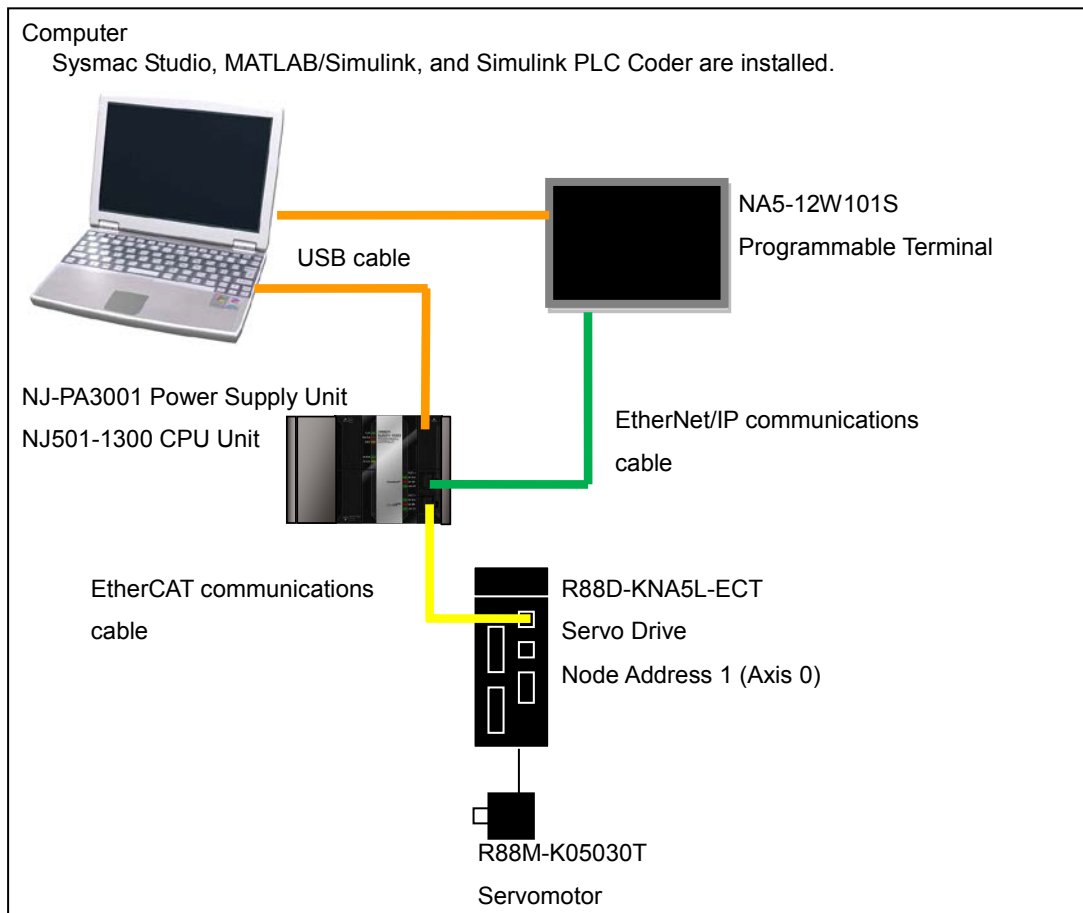

### Precautions for Correct Use

Please start only one session each for the MATLAB and the Sysmac Studio.

If more than one session is started for either of them, the co-simulation of Simulink and Sysmac Studio cannot run. Also, more than one Simulink model file cannot be executed in parallel (i.e., at the same time).

The models of the devices that are described in this Guide are given in the following table. When selecting devices for an actual application, refer to the device manuals.

Device name	Model	Manual name
NJ-series CPU Unit	NJ501-1300 (Unit version 1.09)	NJ-series CPU Unit Hardware User's Manual (Cat. No. W500)
NJ-series Power Supply Unit	NJ-PA3001	
EtherCAT communications cables EtherNet/IP communications cables	XS5W-T421-CMD-K	
Programmable Terminal	NA5-12W101S (version 1.01)	NA-series Programmable Terminal Hardware User's Manual (Cat. No. V117)
AC Servo Drives	R88D-KNA5L-ECT (version 2.10)	AC Servomotors/Servo Drives (Built-in EtherCAT Communications) User's Manual (Cat. No. I576)
AC Servomotors	R88M-K05030T	
Motor Power Cables (for the AC Servo Drives)	R88A-CAKA003S	
Encoder Cables (for the AC Servo Drives)	R88A-CRKA003C	
USB cable	Commercially available USB cable*1	---

\*1. Use a USB2.0 (or 1.1) cable (A connector - B connector), 5.0 m max.

The names and versions of the software that are used in this Guide are given below. Install the following software to a computer (OS: Windows 7 64bit).

Manufacturer	Name	Version
OMRON Corporation	Sysmac Studio	Version 1.12
The MathWorks Inc.	MATLAB/Simulink	R2014b
The MathWorks Inc.	Simulink PLC Coder	R2014b



## 1.2. The Servo System Constructed in this Guide

This guide describes the procedure to start up the system for single-axis positioning with a Servo Drive and Servomotor for one axis. The operations from creating the control algorithm using the Simulink® from the MathWorks® Inc. to operation check using the actual devices are given as the startup procedure.

The single-axis Servo system that is set up in this Guide performs the single-axis positioning operation on the following path.

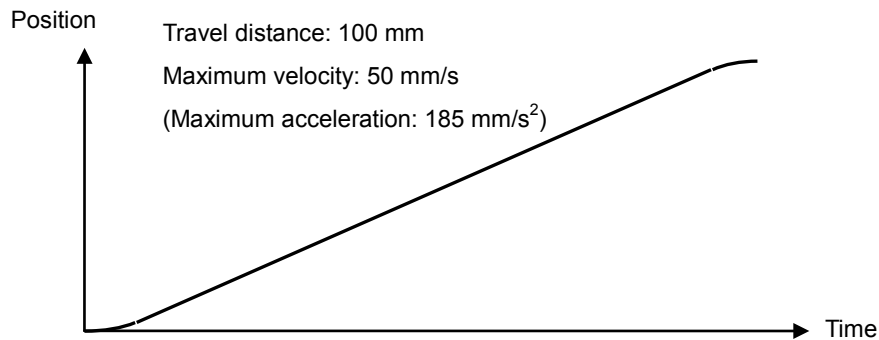

The mechanical configuration is as shown below.

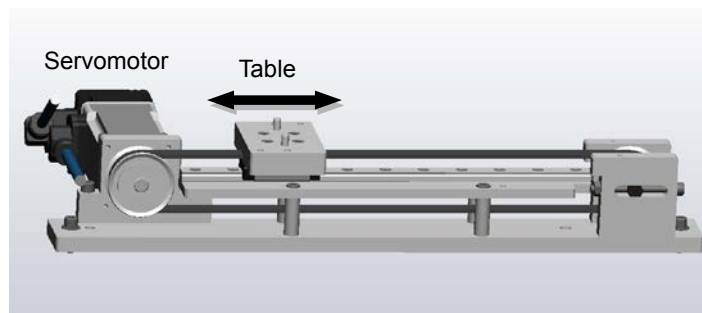

Item		Specifications
Servomotor	Rated speed	3,000 r/min
	Rotor inertia	$0.025 \times 10^{-4} \text{ kg m}^2$
	Rated torque	0.16 N m
	Command pulse count per motor rotation	131,072 <sup>*1</sup>
Mechanism	Work travel distance per motor rotation	96 mm
	Inertia	$0.375 \times 10^{-4} \text{ kg m}^2$ <sup>*2</sup>

\*1. This value is set to 131,072 to match the resolution of the servomotor with 17-bit absolute encoder.

\*2. Inertia ratio = Load inertia/rotor inertia x 100 % = 1500 %

### 1.3. Sample File List

The following sample files are related to this Guide.

We provide the sample files separately.

No.	File Name	Description
1	PLCCoderDemoMC.mdl	File that contains the Simulink model described in 2.2. <i>Designing the Control Algorithm</i> of this Guide.
2	PLCCoderDemoMC.smc2	Sysmac Studio project file that contains Sysmac Studio programs described in 3.2.6. <i>Creating Programs</i> of this Guide.
3	PLCCoderDemoMC_Torque.smc2	Sysmac Studio project file that contains the program to output torque commands cyclically.
4	PLCCoderDemoMC_ADDA.mdl	File that contains the Simulink model that shows the usage example of GX-AD0471 Analog Input Terminal and GX-DA0271 Analog Output Terminal.
5	PLCCoderDemoMC_ADDA.smc2	Sysmac Studio project file that shows the usage example of GX-AD0471 Analog Input Terminal and GX-DA0271 Analog Output Terminal.
6	SILSDemoMC.mdl	File that contains the Simulink model described in 3.2.8. <i>Preparing the Co-simulation of Simulink and Sysmac Studio</i> of this Guide.
7	RMCDemoMC.mdl	File that contains the Simulink model described in 3.2.12. <i>System Operation Check</i> of this Guide.
8	PLCCoderDemoMC_LD.mdl	File that contains the Simulink model described in 4.1. <i>Programming in Ladder Diagram Language</i> of this Guide.
9	PLCCoderDemoMC_LD.smc2	Sysmac Studio project file that contains Sysmac Studio programs described in 4.1. <i>Programming in Ladder Diagram Language</i> of this Guide.

## 2. Before You Begin

### 2.1. Wiring the Devices and Installing the Software

You wire the devices and install the software on the computer as described in 1.1. *System Configuration and Configuration Devices*.



#### Additional Information

- Refer to the manuals for the devices that are used in the system for wiring of the devices.
- Refer to the *Sysmac Studio Version 1 Operation Manual* (Cat. No. W504) for installation of the Sysmac Studio.
- Access the website of The MathWorks Inc. or refer to the *MATLAB & Simulink Installation Guide* that is provided by The MathWorks Inc. for installation of MATLAB/Simulink and Simulink PLC Coder.

You make the MATLAB environment settings for using the linked functions of Simulink and Sysmac Studio according to the following procedure.

- 1 Start the MATLAB and select the MATLAB folder in the directory where the Sysmac Studio is installed as the Current Folder. (The default installation folder is *C:\Program Files (x86)\OMRON\Sysmac Studio\MATLAB*.)

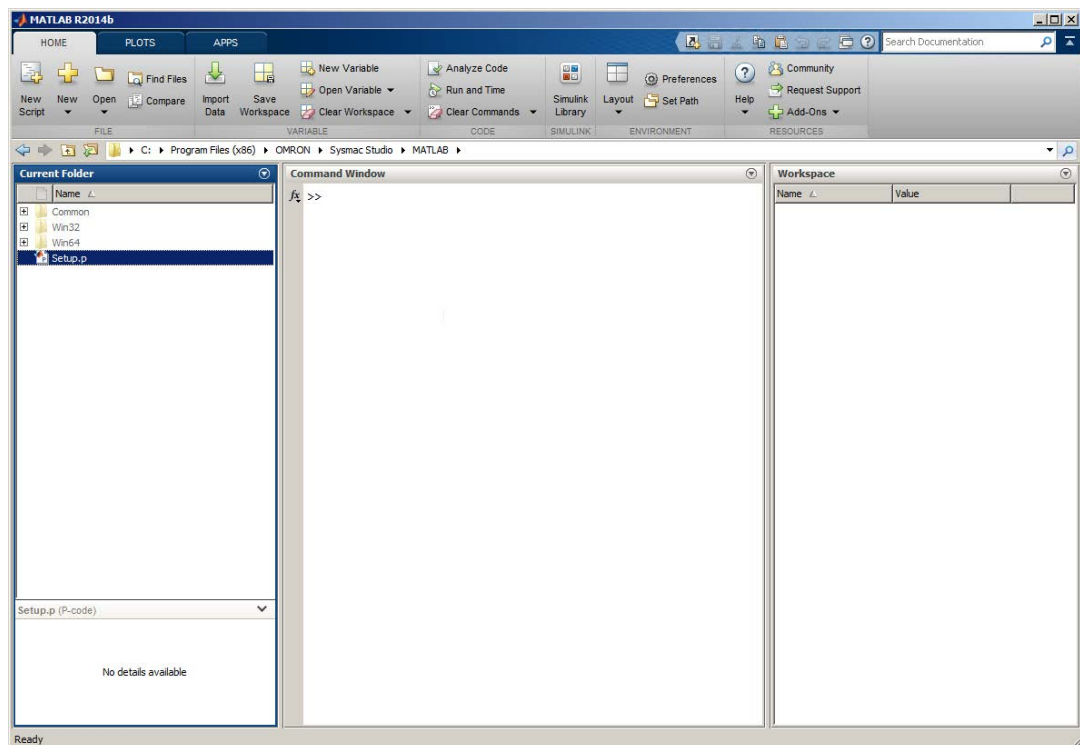

2 Right-click *Setup.p* and select **Run** from the menu.

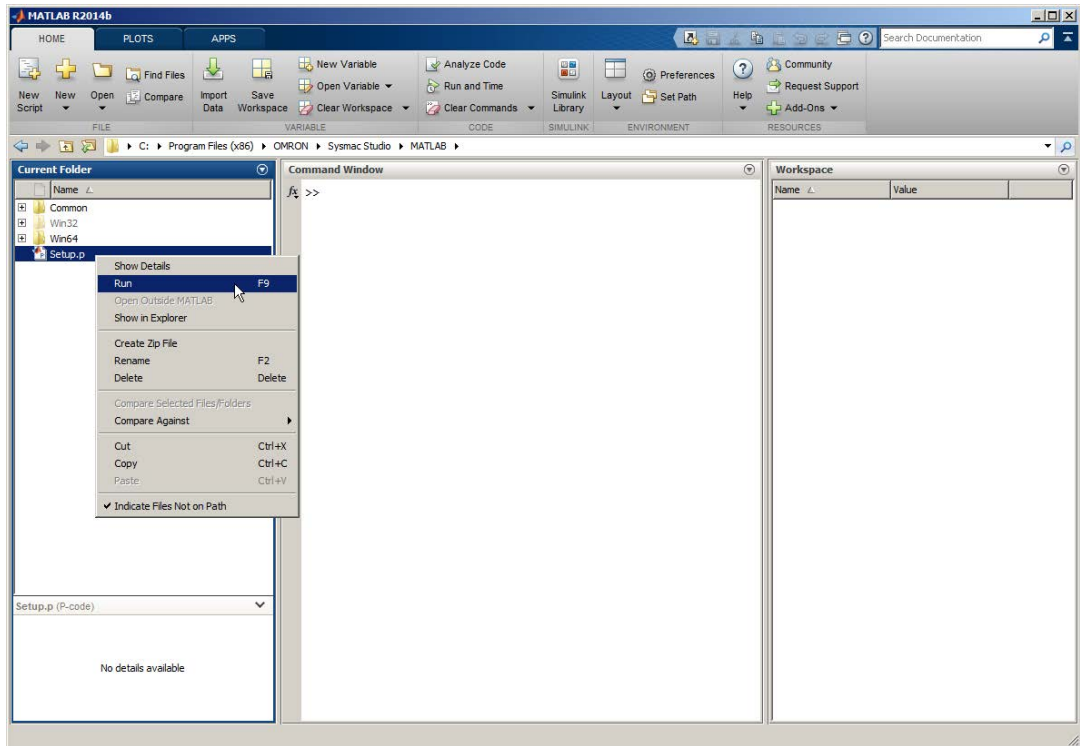

3 Confirm that *Sysmac Studio interface setup has been completed successfully* is displayed in the Command Window.

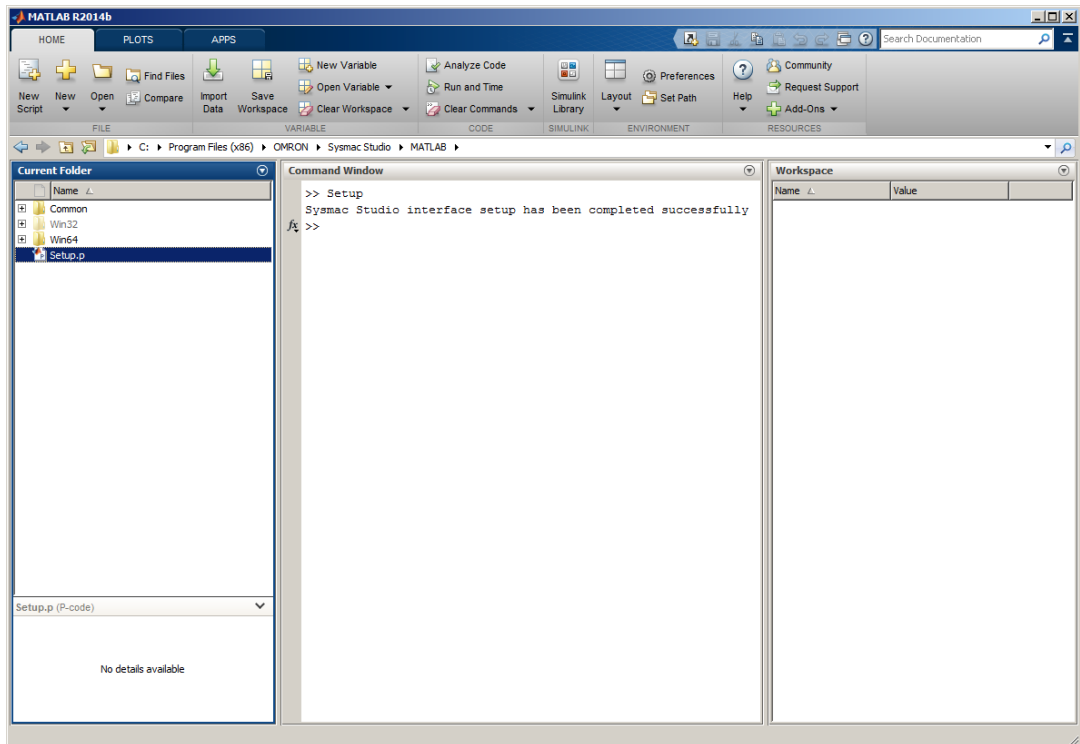

## 2.2. Designing the Control Algorithm

You build a model for the Controller and controlled system using the Simulink. The code is created for the Controller by the Simulink PLC Coder. Therefore, you need to build the model using a block supported by the Simulink PLC Coder.



### Additional Information

- Access the website of The MathWorks Inc. or refer to the *Simulink User Guide* that is provided by The MathWorks Inc. for how to use the Simulink.
- Access the website of The MathWorks Inc. or refer to the *Simulink PLC Coder User's Guide* that is provided by The MathWorks Inc. for the blocks supported by the Simulink PLC Coder.

This Guide gives an example for designing the control algorithm so that an NJ-series CPU Unit controls the position and a Servo Drive controls the velocity.

In the *Sample File No. 1 PLCCoderDemoMC.mdl* that is provided separately, a model is created for the Controller (Controller block) and controlled system (ControlledSystem block) by the Simulink as shown in the following figure.

The sampling time of the Controller is set to 1 ms in the sample.



### Additional Information

Set the sampling time of the Controller so that it matches the task period of the Sysmac Studio. (Primary periodic task period on the Sysmac Studio: 500  $\mu$ s, 1 ms, 2 ms, or 4 ms)

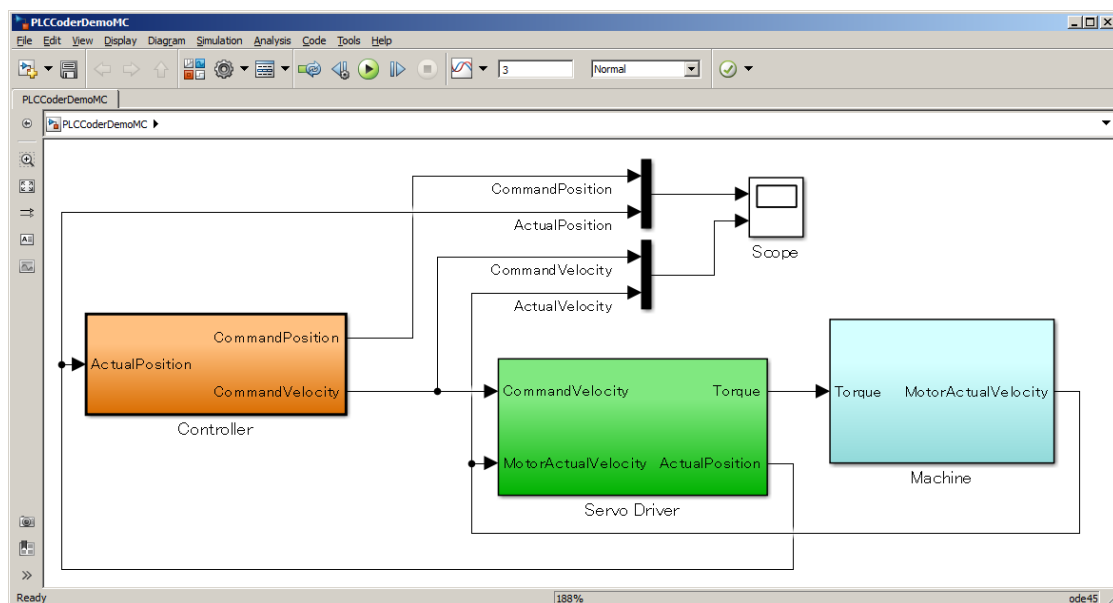

The following figure shows the inside of the Controller block.

The Controller block is composed of two blocks; the CommandPositionGenerator block for creating position command values and the PositionController block for position control.

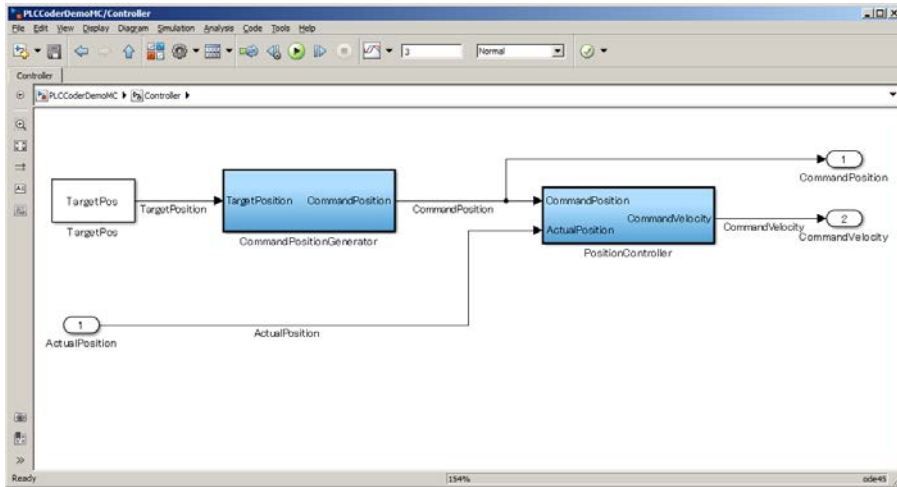

The inside of the PositionController block is shown below.

$K_p$  is the adjustable parameter.

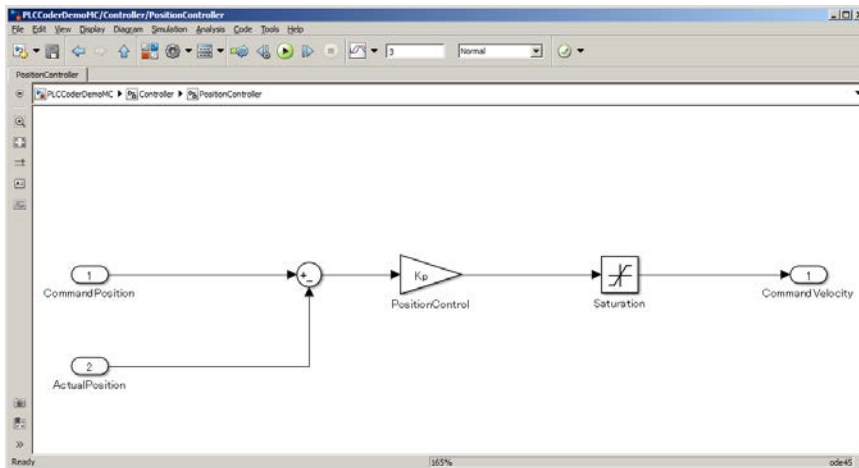

You will get the simulation execution results (Scope) as shown below. The characteristics will be changed by changing  $K_p$ .

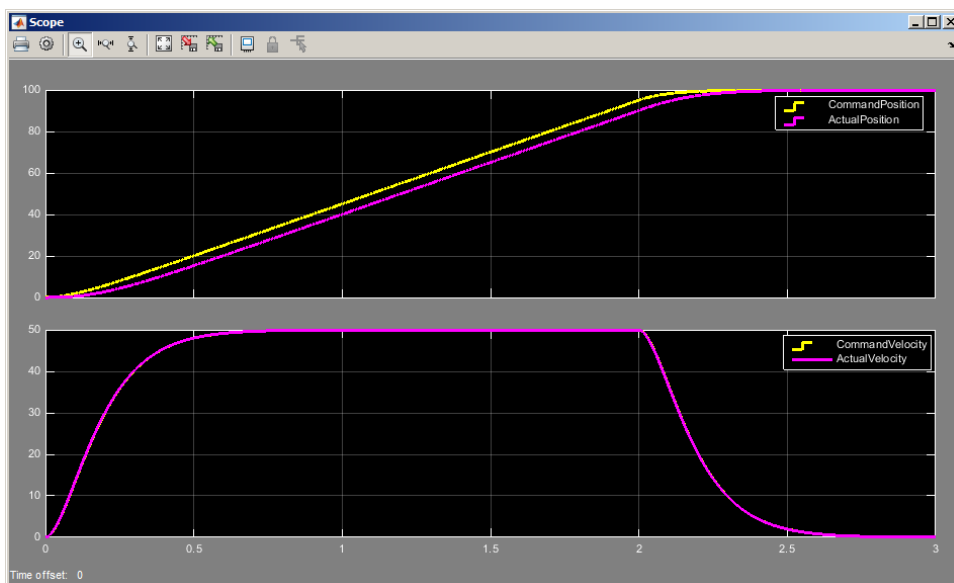

## 3. Setting up the System

### 3.1. System Setup Procedures

The operation procedure of Simulink and Sysmac Studio is given below.

3.2.1	Outputting the Code using the Simulink PLC Coder	You make a setting for outputting the code for the Sysmac Studio and output the code with test code.
	▼	
3.2.2	Importing the Code into the Sysmac Studio	You import the code outputted by the Simulink PLC Coder into the Sysmac Studio.
	▼	
3.2.3	Checking the Calculation Accuracy	You confirm that the code has the same calculation accuracy as the Simulink (within the acceptable error range) by a simulation.
	▼	
3.2.4	Creating the EtherCAT Network Configuration	You register a R88D-KN01L-ECT Servo Drive that operates as axis 0 on the EtherCAT network configuration.
	▼	
3.2.5	Setting the Axis	You add an axis to control the Servo Drive, assign the Servo Drive to the axis, and make the axis parameter settings.
	▼	
3.2.6	Creating Programs	You create a program for calling the function blocks whose code was outputted by the Simulink PLC Coder and a program for outputting command values to the Servo Drive.
	▼	
3.2.7	Creating the Programming Terminal Screen	You insert the Programmable Terminal in the Sysmac Studio project and create a Programmable Terminal screen for the operation and display.
	▼	
3.2.8	Preparing the Co-simulation of Simulink and Sysmac Studio	You add the Sysmac Controller Interface block to the Simulink model and make the setting for data exchange between Simulink and Sysmac Studio. Also, you add the Sysmac IO Device block to link with the parameter settings of the Servo Drive in the Sysmac Studio project.
	▼	
3.2.9	Debugging by Simulation	You debug the programs and screens that you created by the SILS (Software In the Loop Simulation).
	▼	

3.2.10	Transferring the Programs to the CPU Unit and Servo Drive	You transfer the programs and parameter settings to the physical CPU Unit and Servo Drive.
	▼	
3.2.11	Transferring Screen Data to Programmable Terminal	You transfer the screen data that you created to the physical Programmable Terminal.
	▼	
3.2.12	System Operation Check	You execute the operation according to the programs transferred to the physical device and check the operation by comparing it with the simulation using the function for data acquisition from the NJ-series CPU Unit to the Simulink.



## 3.2. Simulink PLC Coder & Sysmac Studio Operation Procedure

### 3.2.1. Outputting the Code using the Simulink PLC Coder

You make a setting for outputting the code for the Sysmac Studio and output the code with test code from the Simulink.

- 1 Open the *Sample File No. 1 PLCCoderDemoMC.mdl* that is provided separately on the Simulink.

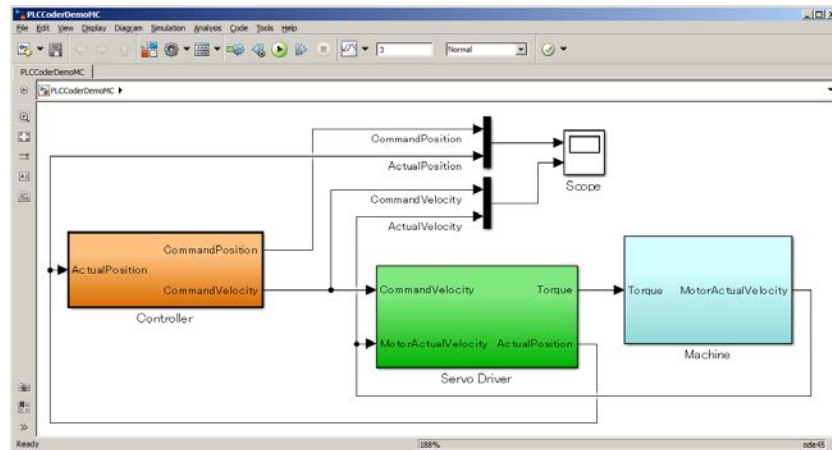

- 2 Click the Controller block to output the code and select **PLC Code - Options** from the Code Menu.

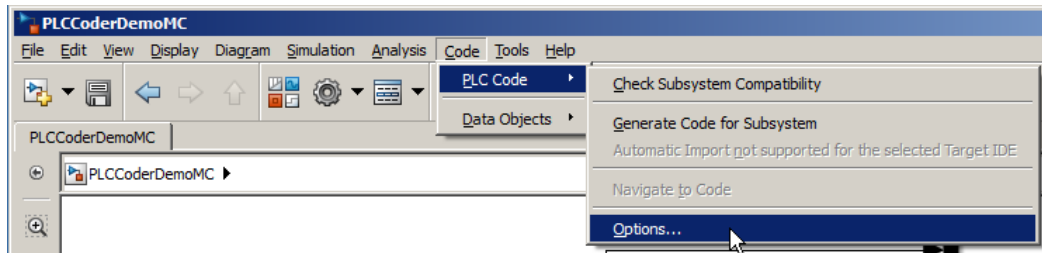

- 3 Select **PLC Code Generation**, and then select **OMRON Sysmac Studio** for Target IDE.

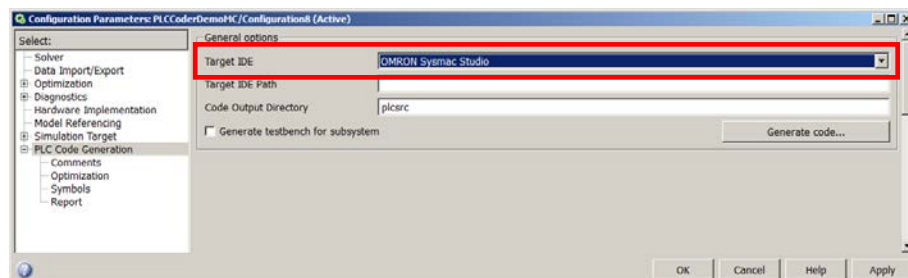

4 Select the *Generate testbench for subsystem* check box.

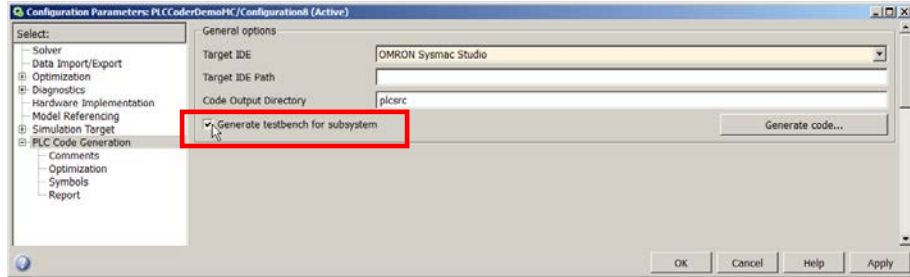

5 Click the **Apply** Button.

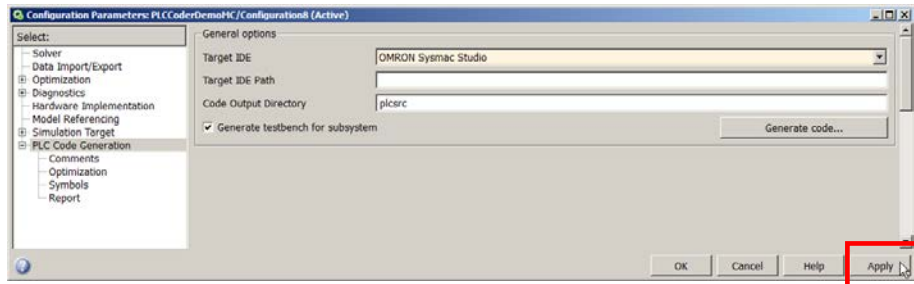

6 Click the **Generate Code** Button.

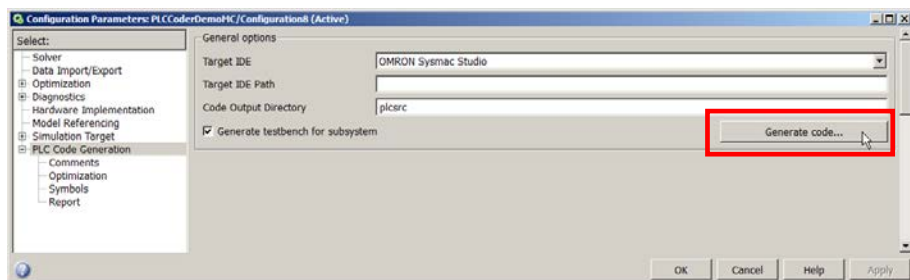

7 The PLCCoderDemoMC.xml file is saved into the *plcsrc* folder specified in *Code Output Directory*.

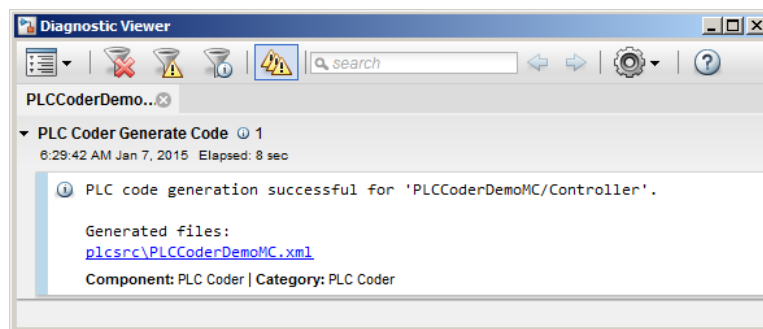

### Additional Information

When you adjust the parameters after code generation, you generate the code as a variable, not a constant (literal). Access the website of The MathWorks Inc. or refer to the *Simulink PLC Coder User's Guide* that is provided by The MathWorks Inc. for the setting procedure.

### 3.2.2. Importing the Code into the Sysmac Studio

You import the code outputted by the Simulink PLC Coder into the Sysmac Studio.



#### Additional Information

Refer to the *Sysmac Studio Version 1 Operation Manual* (Cat. No. W504) for how to use the Sysmac Studio.

- 1 Start the Sysmac Studio and create a new project.  
Set the Select Device Area as shown below.

Category: Controller

Device: NJ501-1300

Version: 1.09

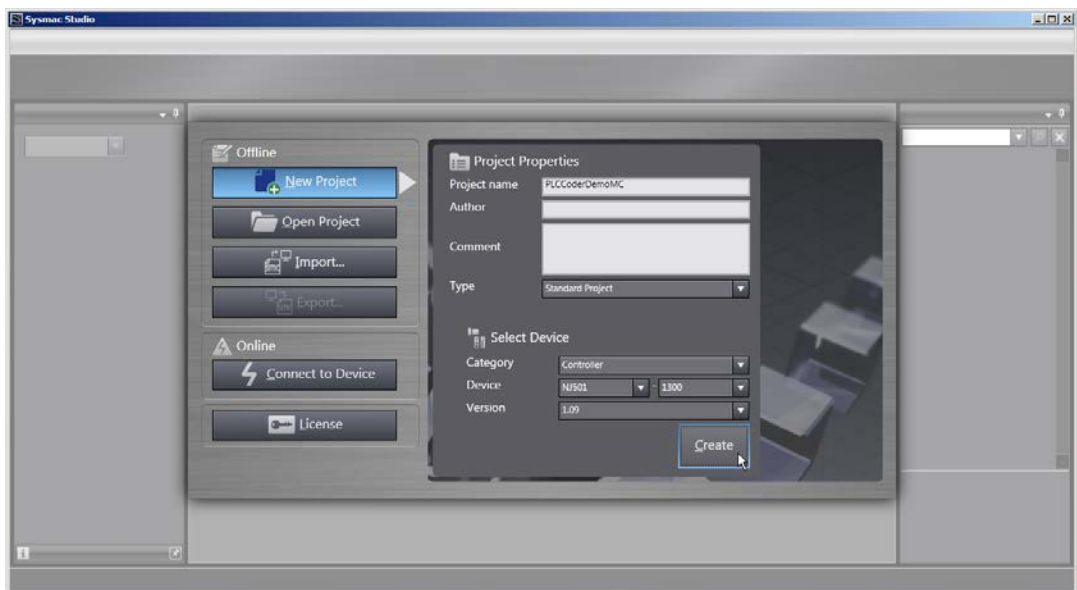

- 2 Delete the **Program0** that is automatically created when a new project is created because it is not used in this Guide.

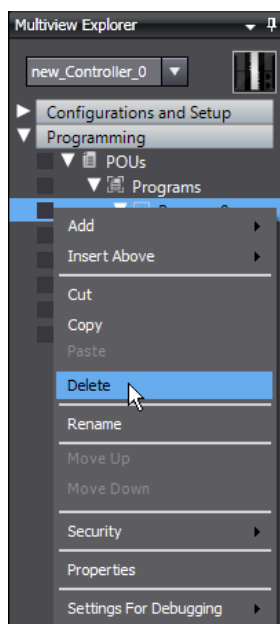

3 Select **Import ST Program** from the **Tools** Menu.

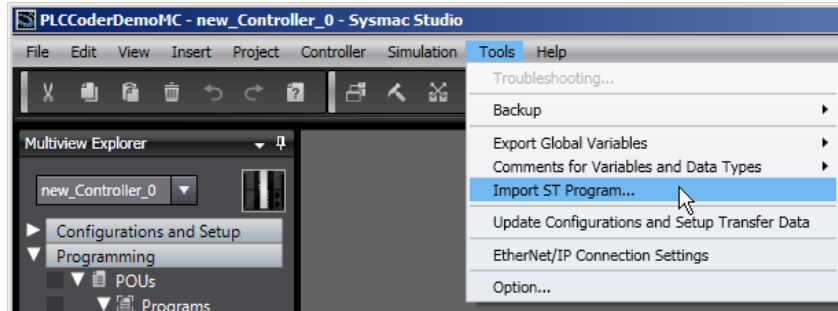

4 Select the PLCCoderDemoMC.xml file that was outputted in the previous section in the Import ST Program Dialog Box.

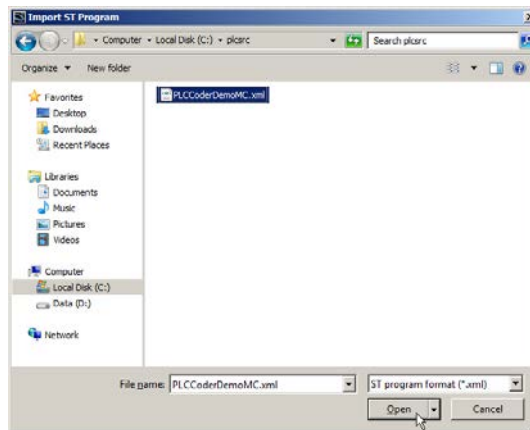

The data is imported and the programs, functions, function blocks, data types, and global variables in the XML file are added to the project of Sysmac Studio.

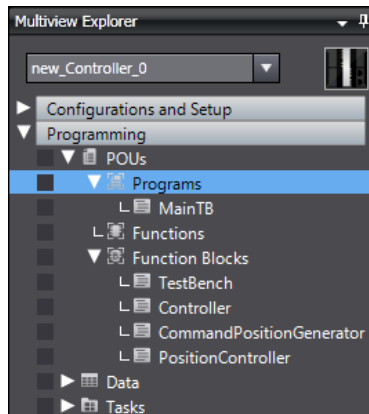

The **Controller** block whose code is outputted by the Simulink PLC Coder and its internal blocks **CommandPositionGenerator** and **PositionController** are imported as function blocks of Sysmac Studio.

**TestBench** is a function block for a test to call the Controller function block.

**MainTB** is a program to call the TestBench function block.

 **Additional Information**

The TestBench function block and the MainTB program are outputted when the *Generate testbench for subsystem* check box is selected in Step 4 of 3.2.1. *Outputting the Code using the Simulink PLC Coder.*

### 3.2.3. Checking the Calculation Accuracy

You confirm that the code has the same calculation accuracy as the Simulink (within the acceptable error range) by a simulation.

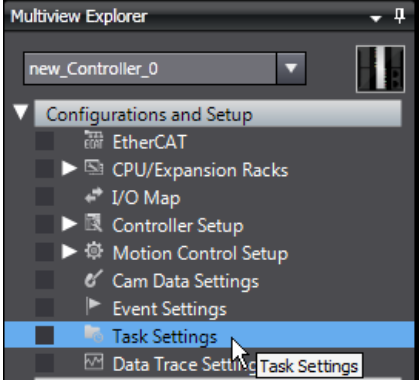
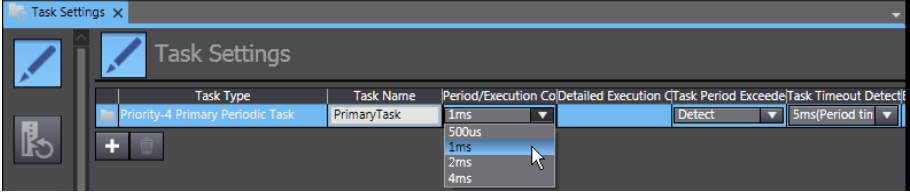
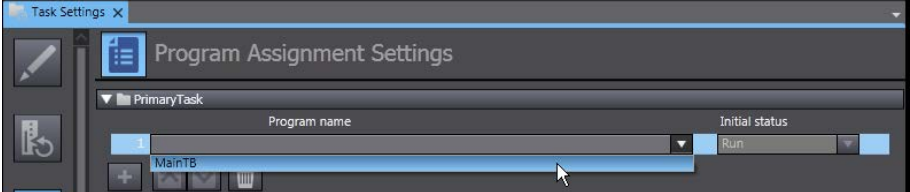
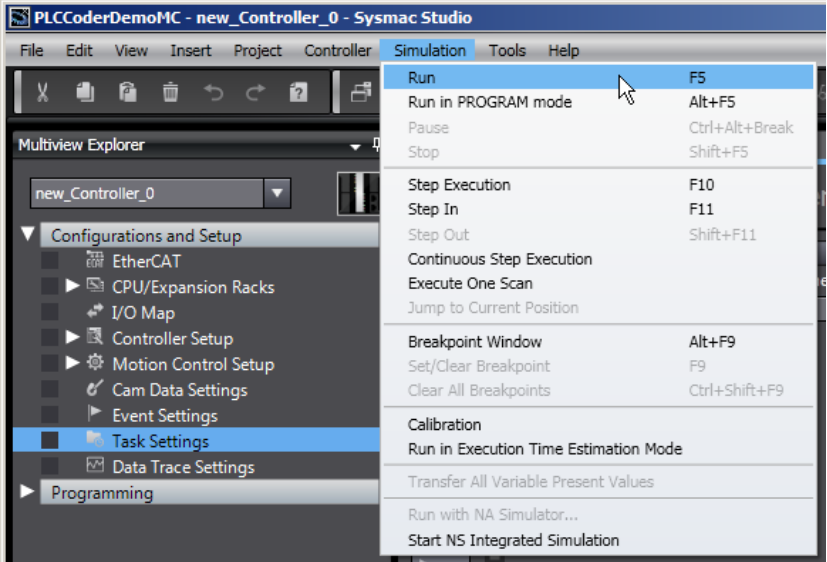
<p>1</p>	<p>Double-click <b>Task Settings</b> in the Multiview Explorer to display the Task Settings Tab Page.</p> 
<p>2</p>	<p>Set the task period to 1 ms in the Task Settings View on the Sysmac Studio so that the period matches the sampling time of the Controller on the Simulink.</p> 
<p>3</p>	<p>Select the MainTB program in the Program Assignment Settings View.</p> 
<p>4</p>	<p>Select <b>Run</b> from the <b>Simulation</b> Menu of the Sysmac Studio.</p> 

- 5 Double-click **TestBench** in the Multiview Explorer to display the program.

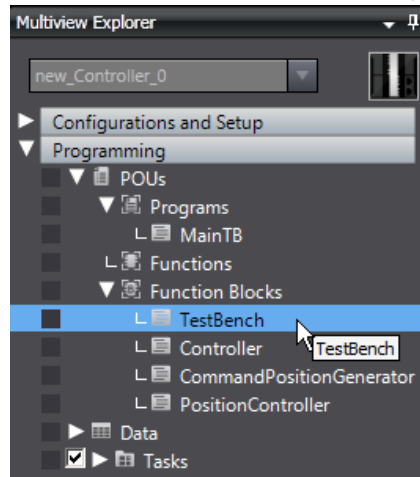

- 6 Confirm that *testVerify* is True and *testCycleNum* is the value of *TEST\_CYCLE\_COUNT* written in the comment.

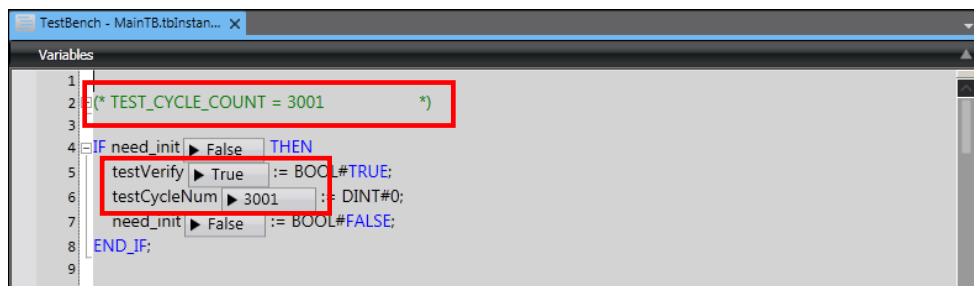

You can confirm that calculation accuracy of the output data is the same level as the Simulink (within the acceptable error range) if *testVerify* is True.

You can also confirm that the simulation has been completed if *testCycleNum* is the value of *TEST\_CYCLE\_COUNT* written in the comment.

### 3.2.4. Creating the EtherCAT Network Configuration

You register a R88D-KNA5L-ECT Servo Drive that operates as axis 0 on the EtherCAT network configuration.

- 1 Double-click **EtherCAT** in the Multiview Explorer to display the EtherCAT Tab Page where you edit the EtherCAT network configuration.

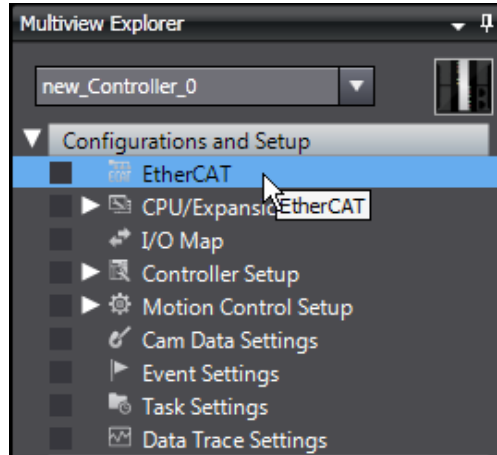

- 2 Drag the R88D-KNA5L-ECT from the Toolbox to the master. The Servo Drive is added under the master with a node address of 1.

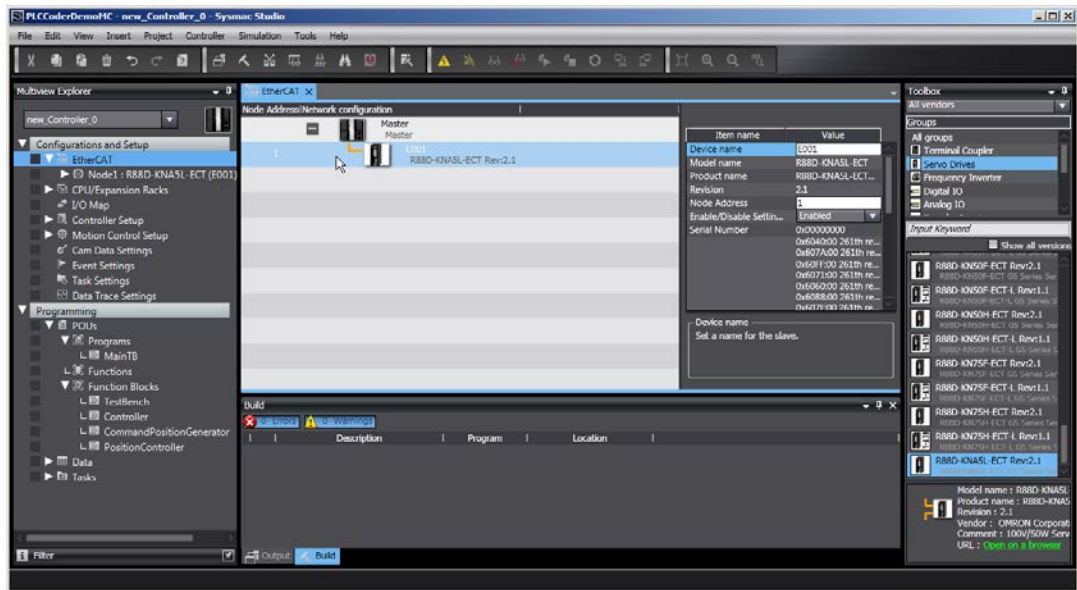

#### Additional Information

To use digital I/O devices, analog I/O devices, and encoder input devices, add the devices using the same procedure. For data access to the devices that you added, register the device variables in the I/O Map.

The examples for using GX-AD0471 Analog Input Terminal and GX-DA0271 Analog Output Terminal are provided as samples. Refer to the *Sample File No. 4 PLCCoderDemoMC\_ADDA.mdl* and *No. 5 PLCCoderDemoMC\_ADDA.smc2* that are provided separately.

### 3.2.5. Setting the Axis

You add an axis to control the Servo Drive, assign the Servo Drive to the axis, and make the axis parameter settings.

- 1 Double-click **Motion Control Setup** in the Multiview Explorer and right-click **Axis Settings** and select **Add - Axis Settings** from the menu.

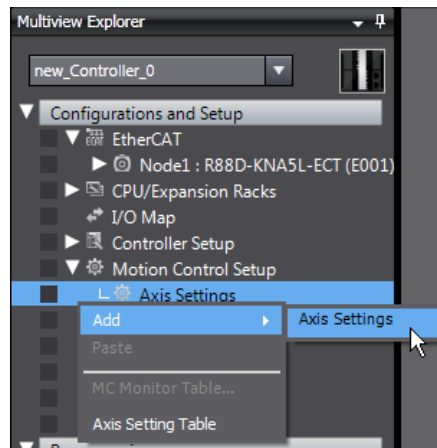

- 2 Double-click **MC\_Axis000(0)** (Axis 0) that was added under **Motion Control Setup - Axis Settings** in the Multiview Explorer to display the axis parameter setting view.

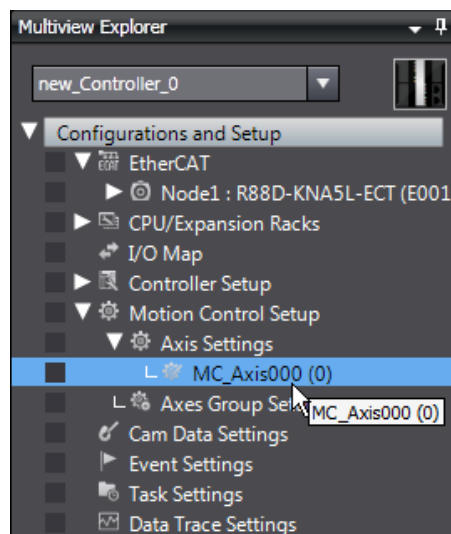

- 3 Make the Axis Basic Settings as shown below to assign the Servo Drive to the axis.  
Axis type: Servo axis  
Output device 1: Node : 1 R88D-KNA5L-ETC(E001)

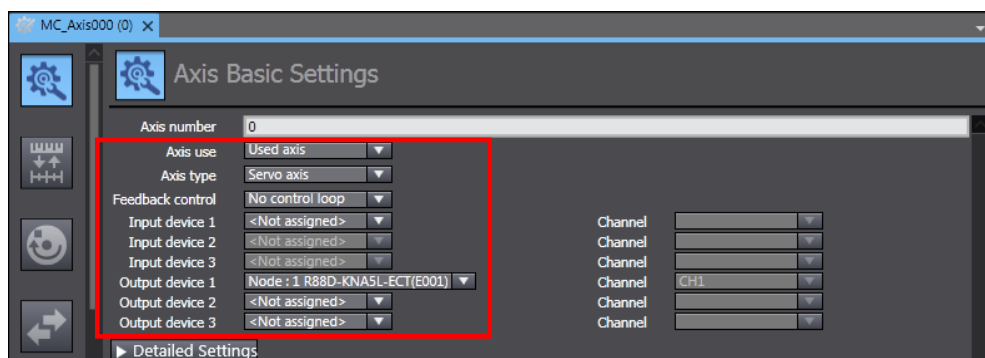



- 4 Make the Unit Conversion Settings according to the mechanical configuration.  
 Unit of display: mm  
 Command pulse count per motor rotation: 131072 pulse/rev  
 Work travel distance per motor rotation: 96 mm/rev

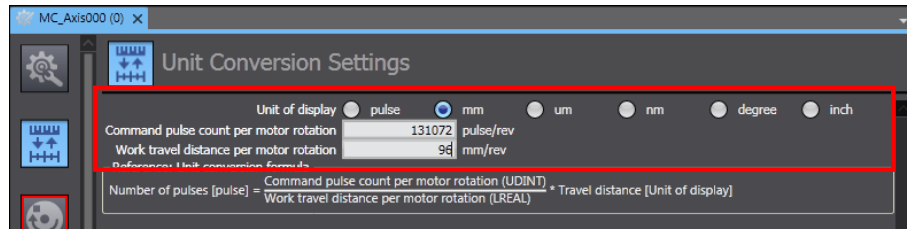

- 5 Make the Operation Settings according to the mechanical configuration.  
 Maximum velocity: 50 mm/s  
 Maximum jog velocity: 50 mm/s

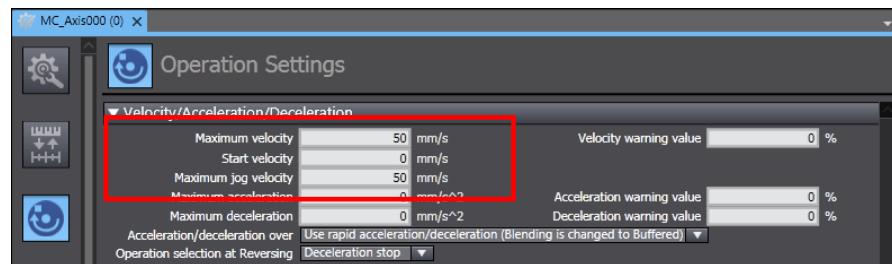

- 6 Right-click **Node1: R88D-KNA5L-ECT** under **EtherCAT** in the Multiview Explorer and select **Parameters** from the menu to display the Parameter Setting Tab Page.

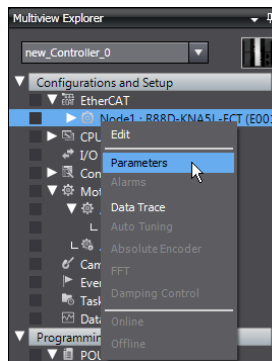

- 7 Set the Servo Drive parameters as shown below according to the mechanical configuration.  
 Inertia Ratio: 1500 %  
 Operation Switch When Using Absolute Encoder: 1: Use as incremental encoder  
 Input Signal Selection 1 to 3: 0: Disabled – Contact A

Disturb	Index	OC	Description	Value	Drive Value	Default	Range	Units
			Pos: Gain Parameters					
	Prd00	3000.00	Autotune Direction Selection	1	1	0	0 to 1	Hex
	Prd01	3001.00	Control Mode Selection	0	0	0	0 to 6	Hex
	Prd02	3002.00	Realtime Autotuning Mode Selection	1	1	0	0 to 6	Hex
	Prd03	3003.00	Realtime Autotuning Maximum Rigidity	10	10	10	10 to 30	%
	Prd04	3004.00	Auto Tuning	0	0	0	0 to 1	Hex
	Prd05	3005.00	Absolute Encoder	0	0	0	0 to 1	Hex
	Prd06	3006.00	FFT	0	0	0	0 to 1	Hex
	Prd07	3007.00	Damping Control	0	0	0	0 to 1	Hex
	Prd08	3008.00	Online	0	0	0	0 to 1	Hex
	Prd09	3009.00	Offline	0	0	0	0 to 1	Hex
	Prd10	3010.00	POU	0	0	0	0 to 1	Hex
			Pos: Inertia Ratio	1500	1500	1500	1500 to 1500	%
			Pos: Operation Switch When Using Absolute Encoder	1	1	0	0 to 2	Hex
			Pos: Regeneration Resistor Selection	3	3	0	0 to 3	Hex
			Pos: External Regeneration Inverter Setting	0	0	0	0 to 4	Hex
			Pos: Can Parameters					
			Pos: Motor Suppression Parameters					
			Pos: 3P Motor Setting Parameters					
	Prd11	3011.00	Input Signal Selection 1 - Position con...	0	0	0	0 to FF	Hex
	Prd12	3012.00	Input Signal Selection 1 - Speed control	0	0	0	0 to FF	Hex
	Prd13	3013.00	Input Signal Selection 1 - Torque control	0	0	0	0 to FF	Hex
	Prd14	3014.00	Input Signal Selection 2 - Inverter con...	0	0	0	0 to FF	Hex
	Prd15	3015.00	Input Signal Selection 2 - Speed control	0	0	0	0 to FF	Hex
	Prd16	3016.00	Input Signal Selection 2 - Torque control	0	0	0	0 to FF	Hex
	Prd17	3017.00	Input Signal Selection 3 - Position con...	0	0	0	0 to FF	Hex
	Prd18	3018.00	Input Signal Selection 3 - Speed control	0	0	0	0 to FF	Hex
	Prd19	3019.00	Input Signal Selection 3 - Torque control	0	0	0	0 to FF	Hex
	Prd20	3020.00	Input Signal Selection 4 - Position con...	0	0	0	0 to FF	Hex

### 3.2.6. Creating Programs

You create a program for calling the function blocks whose code was outputted by the Simulink PLC Coder and a program for outputting command values to the Servo Drive.

- 1 Delete *TestBench* and *MainTB* because they are used for the test to check the calculation accuracy.

Right-click **TestBench** in the Multiview Explorer and select **Delete** from the menu.

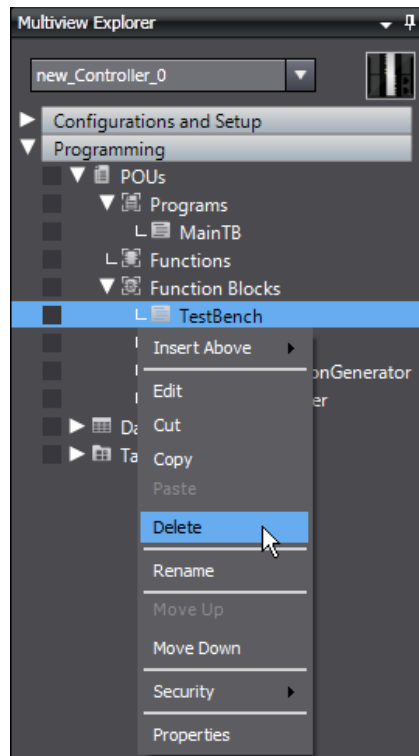

Right-click **MainTB** in the Multiview Explorer and select **Delete** from the menu.

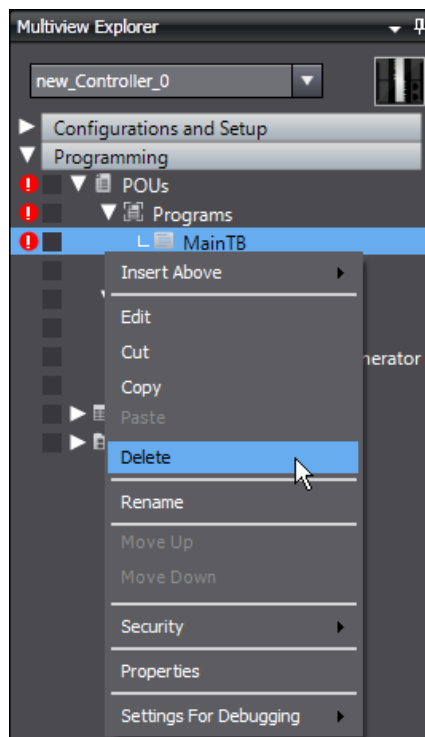

- 2 Create the PositionControl program for the following processing.
- Servo ON (by executing the MC\_Power instruction)
  - Homing (by executing the MC\_Home and MC\_MoveZeroPosition instructions)
  - Calculation of velocity command values by the Controller function block whose code was outputted by the Simulink PLC Coder
  - Output of velocity command values to the Servo Drive (by executing the MC\_SyncMoveVelocity instruction)
  - Execution of the above operations by the signals from the Programmable Terminal
  - Output of the execution status of the above operations to the Programmable Terminal

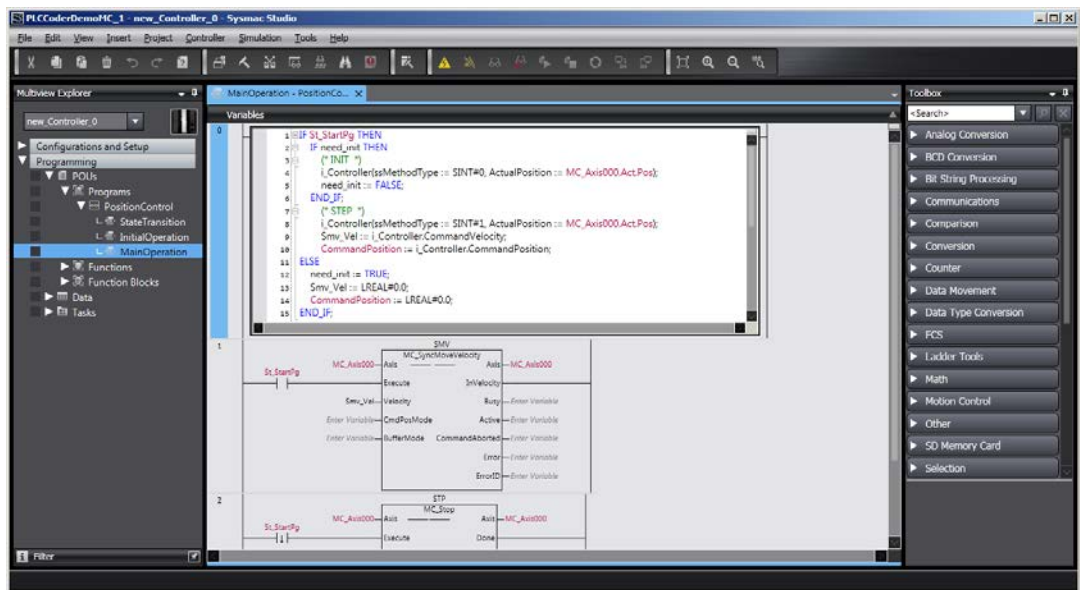

- 3 Double-click Task Settings in the Multiview Explorer to display the Task Settings Tab Page.

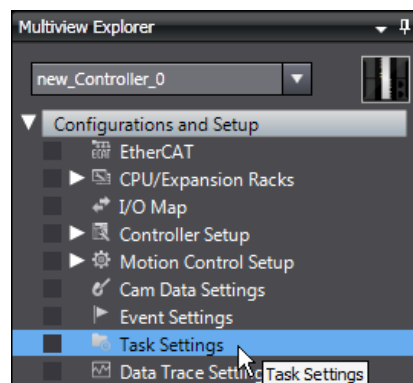

- 4 Set the task period to 1ms in the Task Settings View on the Sysmac Studio so that the period matches the sampling time of the Controller on the Simulink.

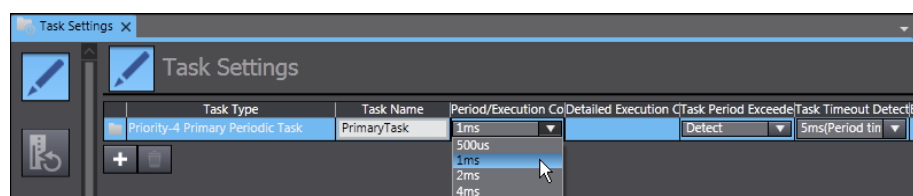

- 5 In the Program Assignment Settings View, select the PositionControl program that you created.

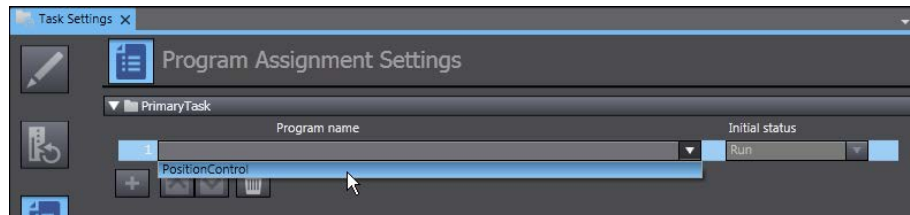

- 6 Check the program that you created.  
Select Check All Programs from the Project Menu.

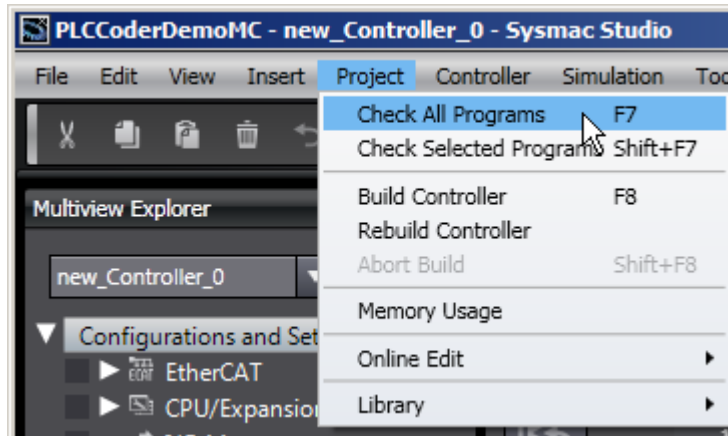

### Precautions for Correct Use

The sample programming that is provided in this Guide includes only the programming that is required to operate the Servomotors. When programming actual applications, also program EtherCAT communications, device interlocks, I/O with other devices, and other control procedures.



### Additional Information

- Refer to the *Sample File No. 2 PLCCoderDemoMC.smc2* that is provided separately for the above program.
- Refer to *4.1. Programming in Ladder Diagram Language* for programming in ladder diagram language.
- The instruction to use differs by the command given to the Servo Drive. Use the following instructions according to the command type.

Position command: MC\_SyncMoveAbsolute

Velocity command: MC\_SyncMoveVelocity

Torque command: MC\_TorqueControl

If you use a MC\_TorqueControl instruction, the command values are not outputted cyclically. You need to write the program so that the command values are outputted cyclically. Refer to the *MC\_mySyncTorqueControl* of the *Sample File No. 3 PLCCoderDemoMC\_Torque.smc2* that is provided separately for the program.

### 3.2.7. Creating the Programming Terminal Screen

You insert the Programmable Terminal in the Sysmac Studio project and create a Programmable Terminal screen for the operation and display.

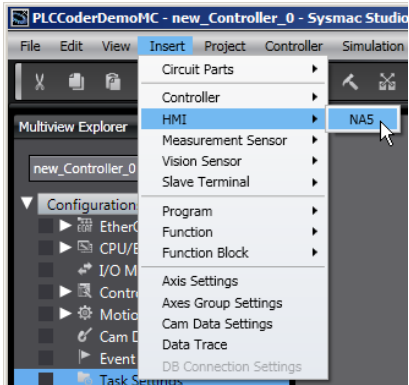
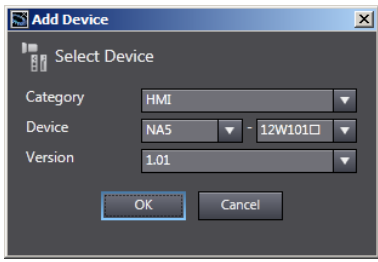
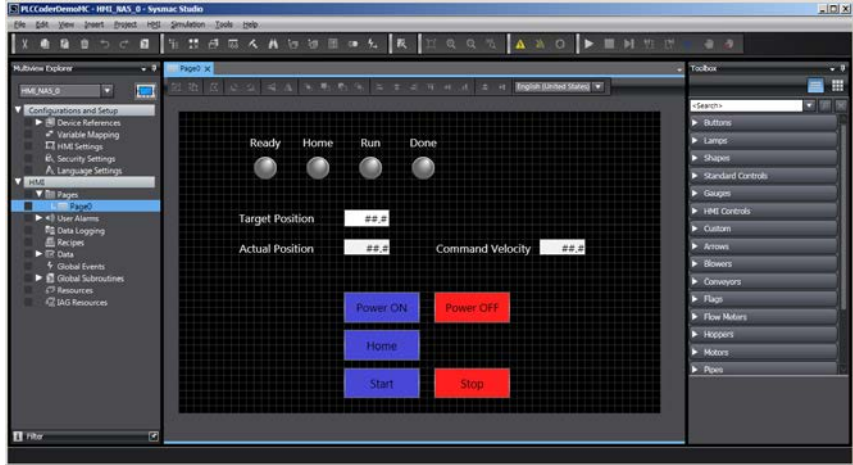
<p>1</p>	<p>Select <b>HMI – NA5</b> from the Insert Menu of the Sysmac Studio.</p> 
<p>2</p>	<p>Make the settings as shown below in the Add Device Dialog Box and click the <b>OK</b> Button.</p> <p>Category: HMI          Device: NA5-12W101 <input type="checkbox"/>          Version: 1.01</p> 
<p>3</p>	<p>Create a Programmable Terminal screen for the following processing.</p> <ul style="list-style-type: none"> <li>- Servo ON/OFF operation and status display</li> <li>- Homing operation</li> <li>- Start/stop of movement to the command position and status display</li> <li>- Status display of completion of movement to the command position</li> <li>- Command position setting and display</li> <li>- Current position display</li> <li>- Velocity command value display</li> </ul> 



#### Additional Information

Refer to the *Sample File No. 2 PLCCoderDemoMC.smc2* that is provided separately for the above program.

### 3.2.8. Preparing the Co-simulation of Simulink and Sysmac Studio

You add the Sysmac Controller Interface block to the Simulink model and make the setting for data exchange between Simulink and Sysmac Studio.

Also, you add the Sysmac IO Device block to link with the parameter settings of the Servo Drive in the Sysmac Studio project.

- 1 Open the *Sample File No. 1 PLCCoderDemoMC.mdl* that is provided separately on the Simulink.

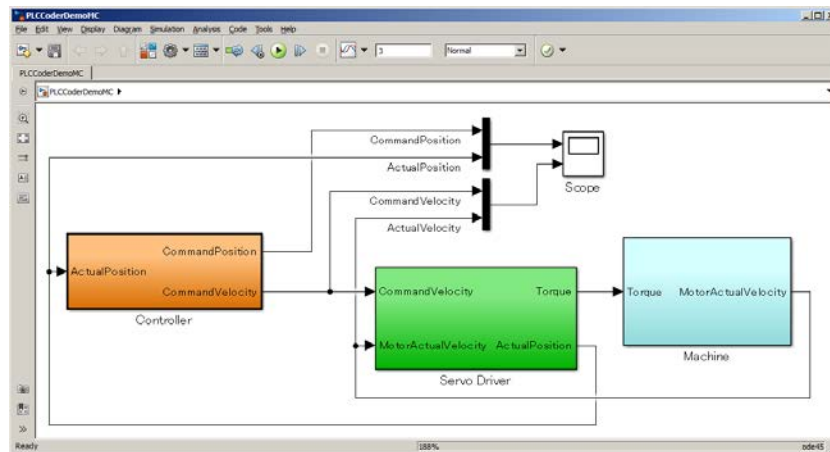

- 2 Select the Sysmac Controller Interface block from the Simulink Library Browser and add it to the Simulink model that you opened in Step 1.

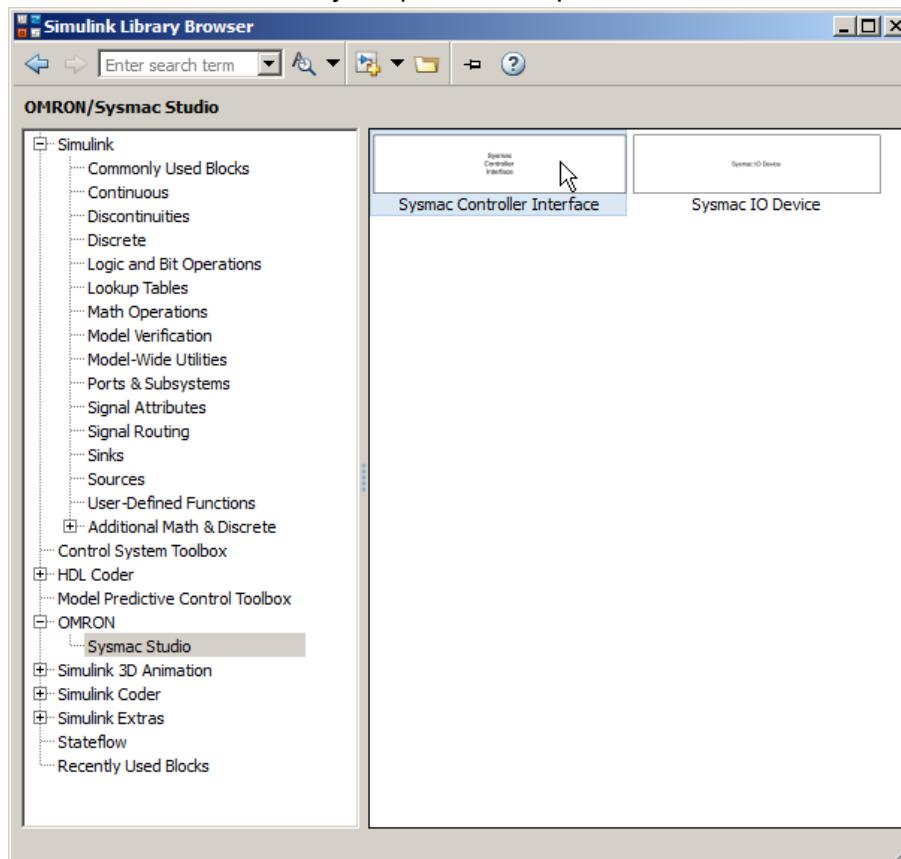

- 3 Double-click the Sysmac Controller Interface block that you added in Step 2 and display the dialog box where to make the setting for data exchange between Simulink and Sysmac Studio's Simulator.

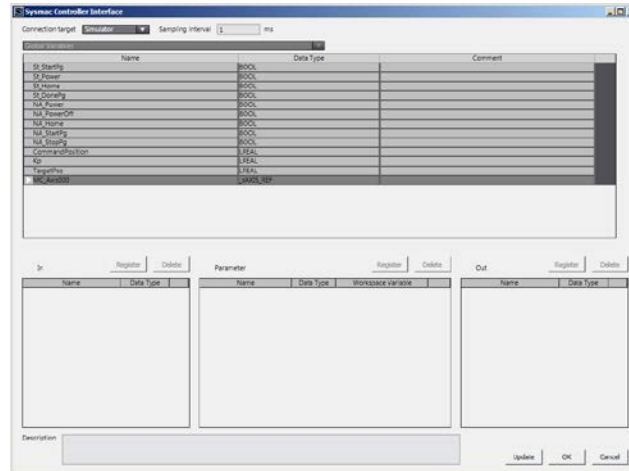

- 4 Select *MC\_Axis000.Act.Pos* from the list of variables in the Sysmac Studio project and click the **Register** Button for the In list to pass the actual current position calculated by the Simulink to the Sysmac Studio's Simulator.

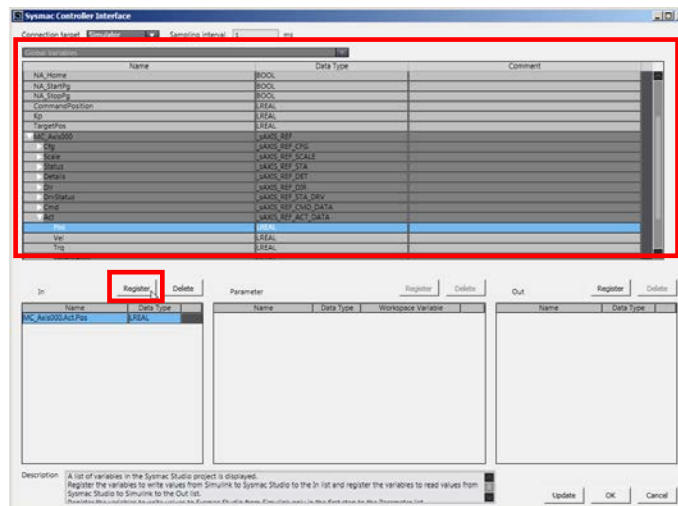

- 5 Select *CommandPosition* from the list of variables in the Sysmac Studio project and click the **Register** Button for the Out list to pass the position command value calculated by the Sysmac Studio's Simulator to the Simulink.

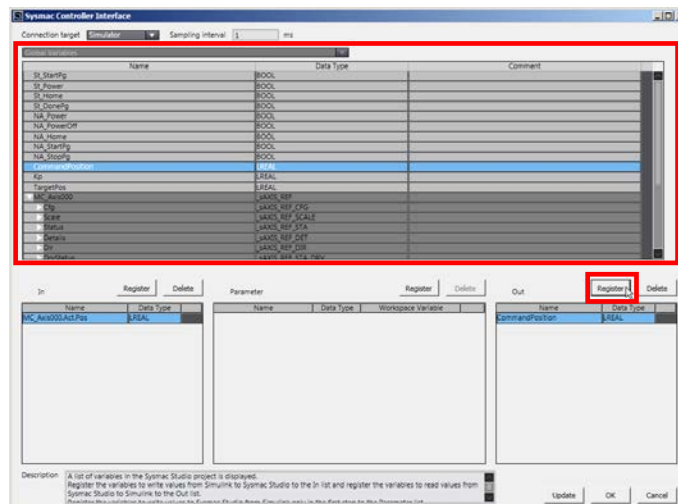

- 6 Select *MC\_Axis000.Cmd.Vel* from the list of variables in the Sysmac Studio project and click the **Register** Button for the Out list to pass the velocity command value for the Servo Drive calculated by the Sysmac Studio's Simulator to the Simulink.

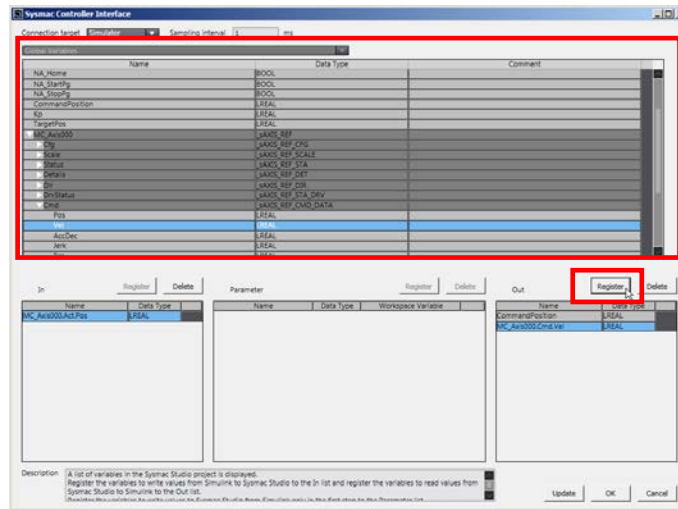

- 7 Select *Kp* from the list of variables in the Sysmac Studio project and click the **Register** Button for the Parameter list to pass the values from Simulink to Sysmac Studio only in the first step,

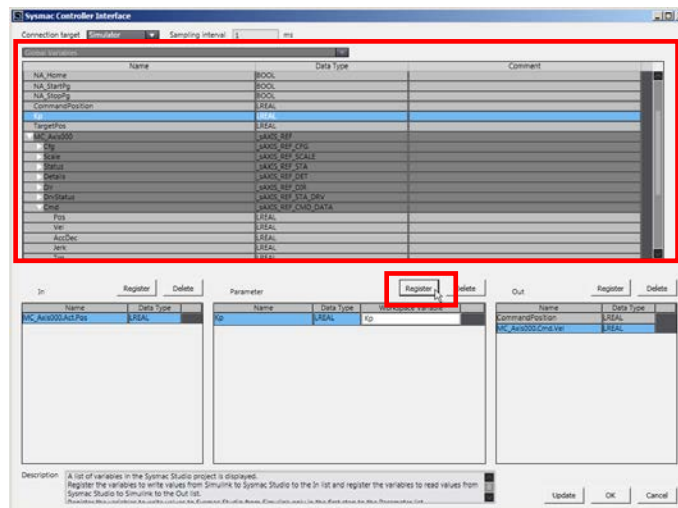

- 8 Click the **OK** Button to close the dialog box.

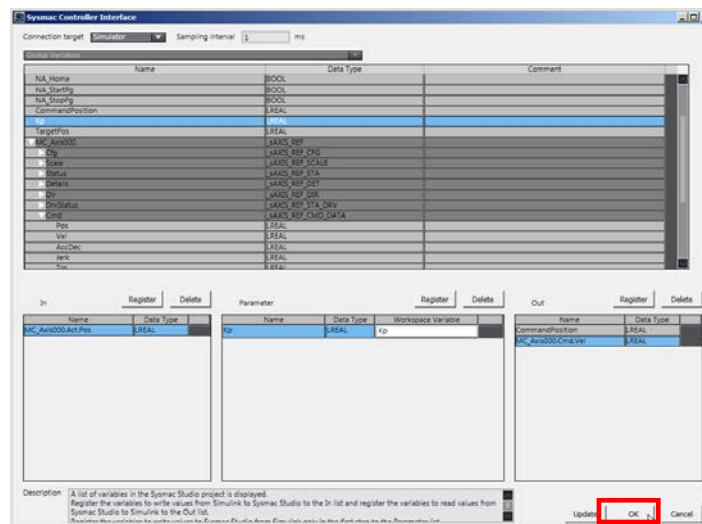



- 9 Delete the Controller block and replace it with the Sysmac Controller Interface block that you added.  
Connect the input signal line and output signal line of the Sysmac Controller Interface block.

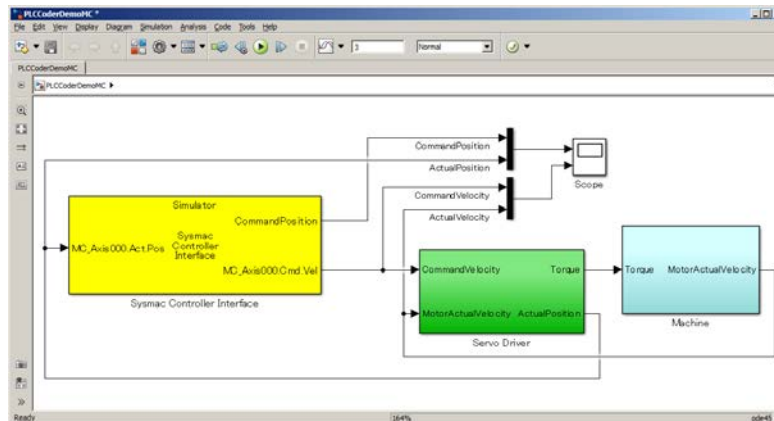

- 10 Select the Sysmac IO Device block from the Simulink Library Browser and add it to the Simulink model.

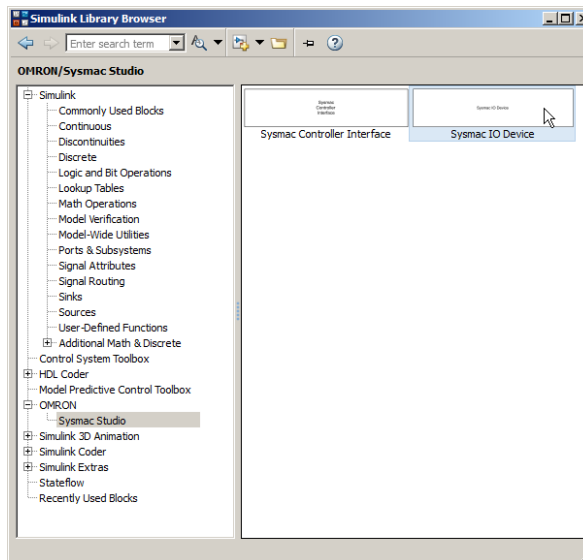

- 11 Double-click the Sysmac IO Device block added in Step 10. The setting dialog box for selecting a device in the Sysmac Studio project is displayed.

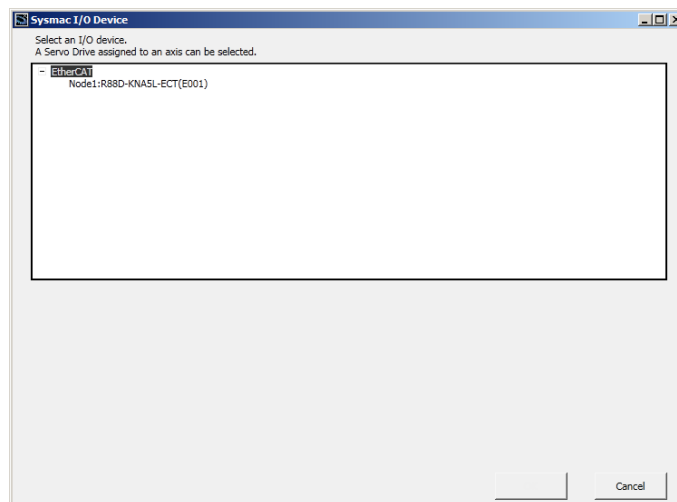

- 12 Select the Servo Drive whose node address is 1 from the EtherCAT network configuration in the Sysmac Studio project.

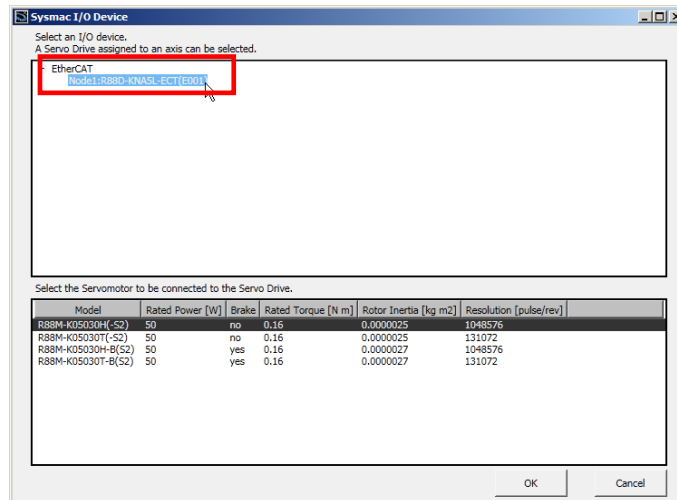

- 13 Select R88M-K10030T from the list of servomotors that can be connected to the Servo Drive selected in Step 12.

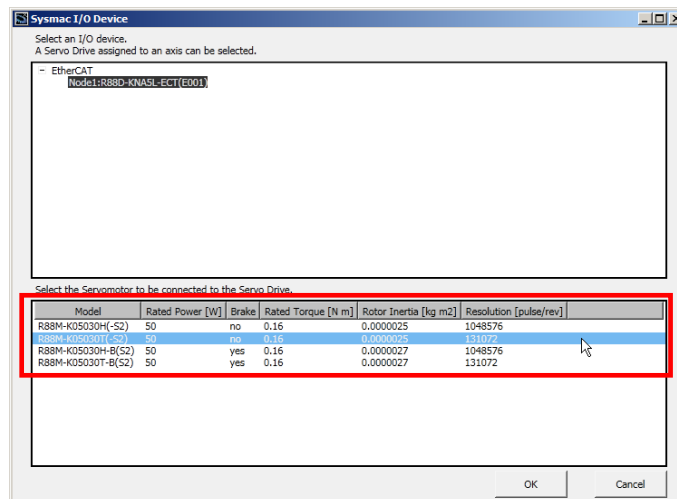

- 14 Click the **OK** Button to close the dialog box.

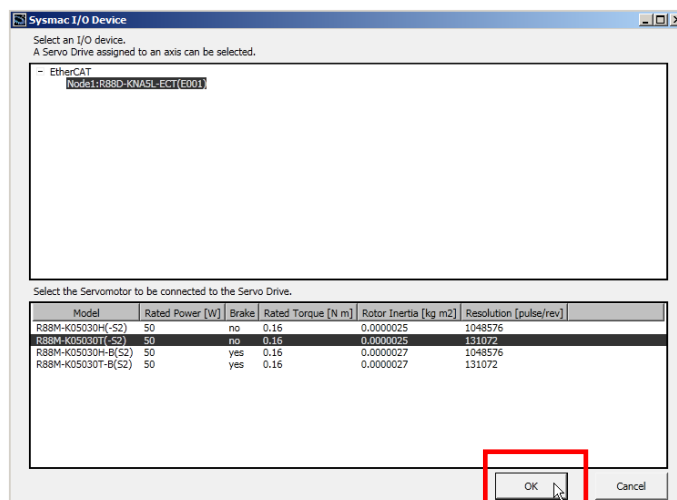

15 Delete the Servo Drive block and replace it with the Sysmac IO Device block that you added. Connect the input signal lines and output signal lines of the Sysmac IO Device block as shown below.

<Inputs>

Modes of operation: Constant (9: Cyclic synchronous velocity mode (csv))

Cmd.Pos: Ground (Not used)

Cmd.Vel: Output (MC\_Axis000.Cmd.Vel) from the Sysmac Controller Interface block

Motor actual velocity: Output (MotorActualVelocity) from the Machine block

<Outputs>

Modes of operation display: Terminator (Not used)

Torque demand: Input (Torque) to the Machine block

Act.Pos: Input (MC\_Axis000.Act.Pos) to the Sysmac Controller Interface block

Act.Vel: Scope

Act.Trq: Terminator (Not used)

Because the unit of input (Torque) to the Machine block is [%], convert the value to the torque in [N m].

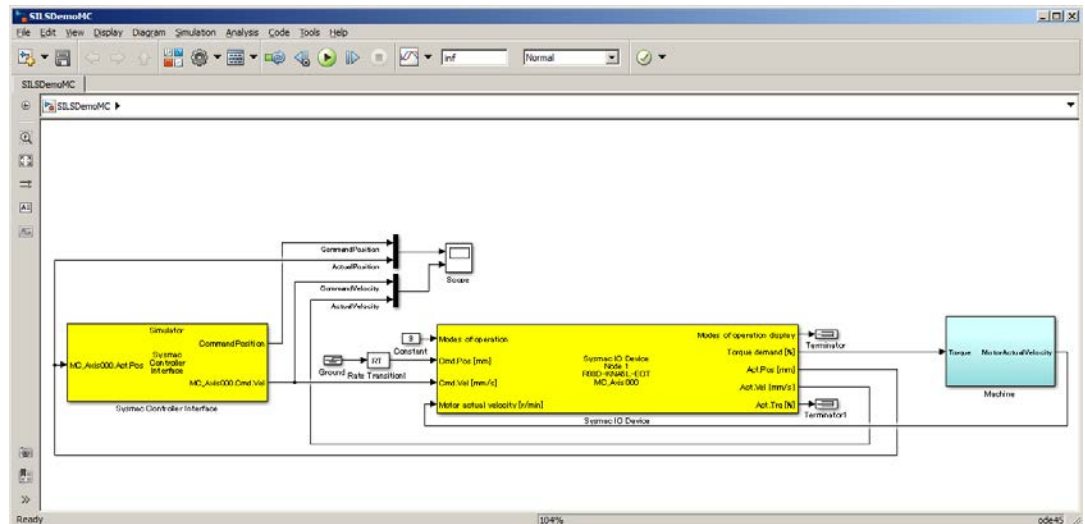



## Additional Information

- Refer to the *Sample File No. 6 SILSDemoMC.mdl* for the Simulink model that you created by the above operation.
- You can add the following axis variable members to the In list.

Variable name (Member)	Name
Act.Pos	Actual current position
Act.Vel	Actual current velocity
Act.Trq	Actual current torque

However, you can add only the axes whose *Axis use* parameter is set to *Unused axis (changeable to used axis)* or *Used axis* and whose *Axis type* parameter is set to *Servo axis* or *Encoder axis*. Like the actual access from Servo Drive or encoder to Controller, these variables are converted to the data type for the PDO communications (*Act.Pos* and *Act.Vel* are converted to DINT data and *Act.Trq* is converted to INT data) for unit conversion of axis variables (i.e., calculation based on the electronic gear ratio setting) using the command pulse count per motor rotation and work travel distance per motor rotation.

- The *Modes of operation* input to the Sysmac IO Device block is corresponding to the operation mode of the process data object (PDO) of the AC Servomotor/Servo Drives G5/1S-series with built-in EtherCAT communications (6060 hex) and refers to 8: *Cyclic synchronous position mode (csp)*, 9: *Cyclic synchronous velocity mode (csv)*, or 10: *Cyclic synchronous torque mode (cst)*.
- The unit of the *Torque demand* output from the Sysmac IO Device block is [%]. To convert the value to the torque in [N m], use the rated torque to calculate it as shown below.

$$\text{Torque [N m]} = \text{Torque [\%]} \times \text{rated torque} / 100$$

You can confirm the rated torque in the setting dialog box for the Sysmac IO Device block.

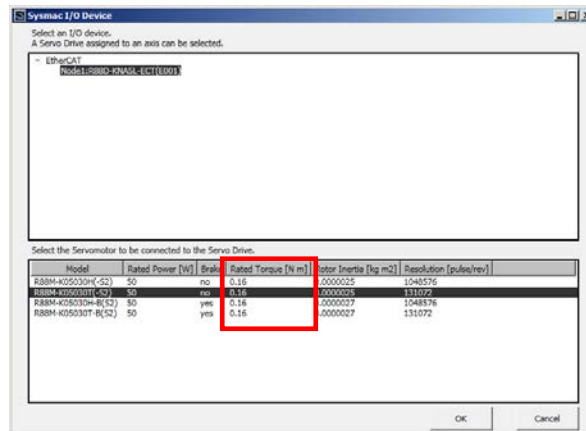

### 3.2.9. Debugging by Simulation

You debug the programs and screens that you created by the SILS (Software In the Loop Simulation).

- 1 Select **Run with NA Simulator** from the Simulation Menu of the Sysmac Studio.

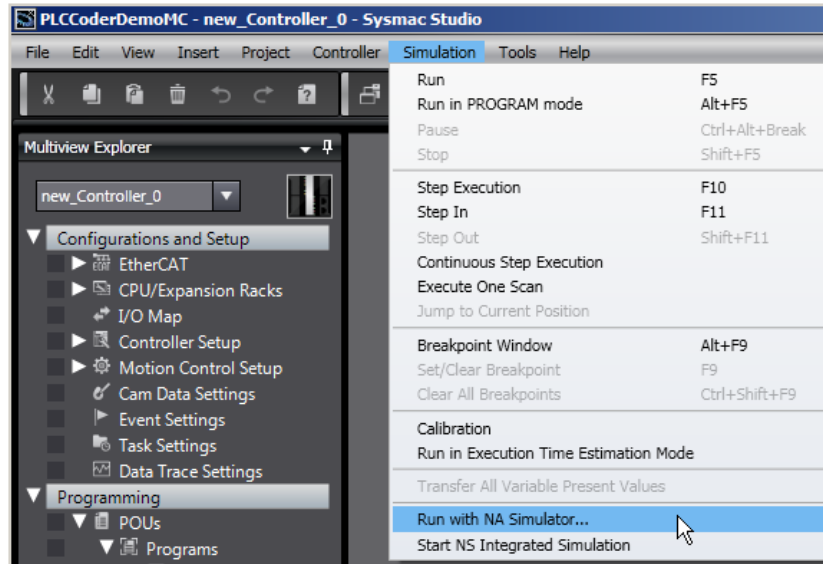

- 2 Select the HMI that you created in 3.2.7. *Creating the Programming Terminal Screen* in the Simulator Option Dialog Box and click the **OK** Button.

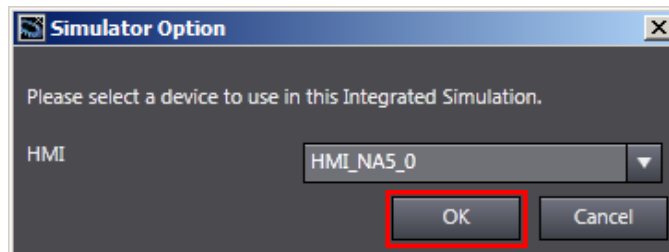

The Simulator of the Programmable Terminal is started.



3 Select **Run** from the Simulation Menu of the Simulink.

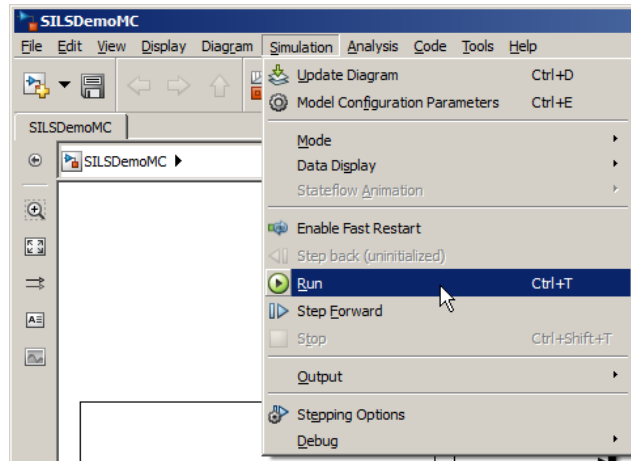

4 Click the **Power ON** Button on the Test Window for the Programmable Terminal. The Servo is turned ON and the **Ready** Lamp is lit.



5 Click the **Home** Button on the Test Window for the Programmable Terminal. The axis is returned to the home.

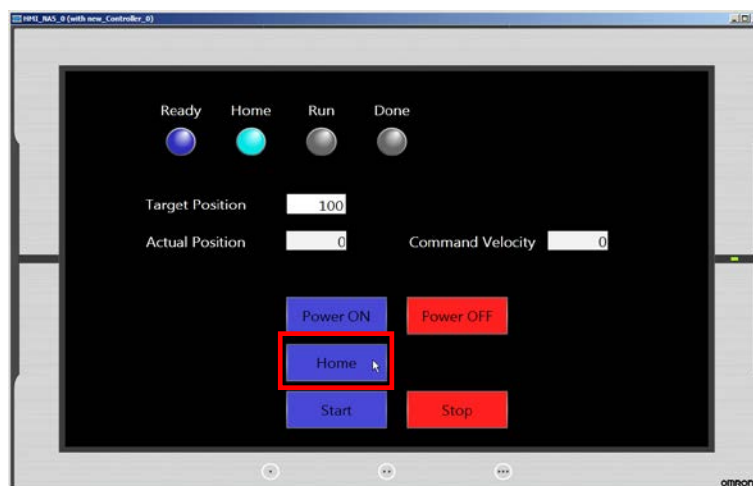

- 6 Click the **Start** Button on the Test Window for the Programmable Terminal. The axis starts moving to the Target Position and the **Run** Lamp is lit. The Actual Position value and Command Velocity value change. When the movement is completed, the **Done** Lamp is lit.



- 7 Check the simulation results (Scope) of the Simulink. You can confirm that you got the similar results as the waveform shown in 1.2. *The Servo System Constructed in this Guide* and 2.2. *Designing the Control Algorithm*.

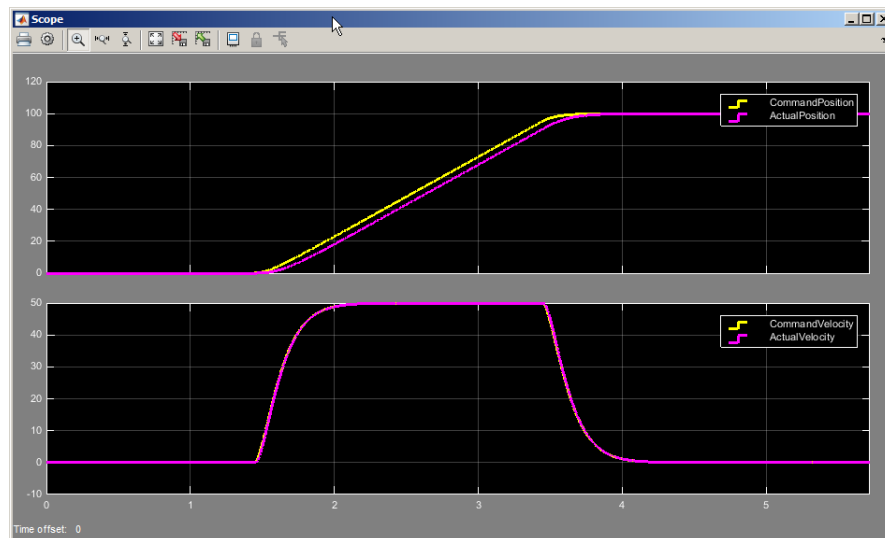

- 8 Use the following procedure to stop the simulation. Select **Stop** from the Simulation Menu of the Simulink.

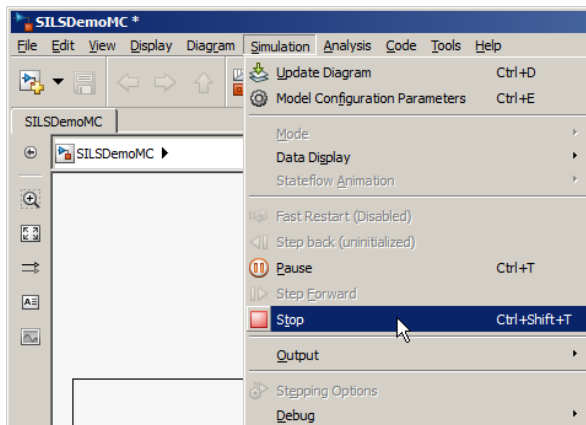

## 9 Select **Stop** from the Simulation Menu of the Sysmac Studio.

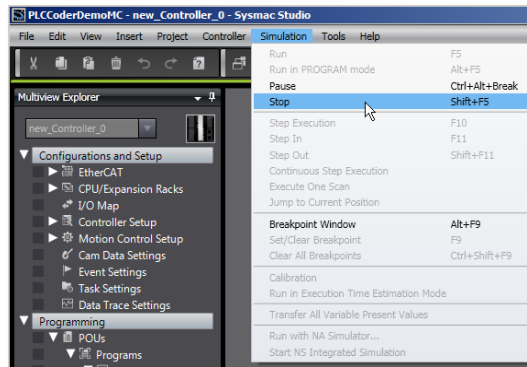

### Precautions for Correct Use

- When the SIM\_SetActPos, SIM\_SetActVel, or SIM\_SetActTrq simulation instruction is used, the Simulink cannot pass the value to the *Act.Pos* (actual current position), *Act.Vel* (actual current velocity), or *Act.Trq* (actual current torque) variable of the Sysmac Studio.  
Do not use the SIM\_SetActPos, SIM\_SetActVel, or SIM\_SetActTrq simulation instruction to pass the value from the Simulink to the *Act.Pos* (actual current position), *Act.Vel* (actual current velocity), or *Act.Trq* (actual current torque) variable of the Sysmac Studio.
- When the SIM\_SetVelocity simulation instruction is used for the encoder axis, the Simulink cannot pass the value to the *Act.Vel* (current velocity) variable of the Sysmac Studio.  
Do not use the SIM\_SetVelocity simulation instruction to pass the value from the Simulink to the *Act.Vel* (current velocity) variable of the Sysmac Studio.
- Unit conversion of the axis variables (i.e., calculation based on the electronic gear ratio setting) uses the command pulse count per motor rotation and work travel distance per motor rotation at the simulation start of the Simulink. Therefore, if the command pulse count per motor rotation or work travel distance per motor rotation is changed by the MC\_WriteAxisParameter instruction during the simulation, the Simulink cannot correctly write the values to the *Act.Pos* (actual current position) variable and the *Act.Vel* (actual current velocity) variable of the Sysmac Studio.  
Do not change the command pulse count per motor rotation or work travel distance per motor rotation when the values are written from the Simulink to the *Act.Pos* (actual current position) variable and the *Act.Vel* (actual current velocity) variable of the Sysmac Studio.



### Additional Information

- Refer to the *Sysmac Studio Version 1 Operation Manual* (Cat. No. W504) for the program debugging procedures.
- The control performance is changed by changing the gain and other parameters of the Servo Drive. Refer to 4.2. *Sysmac IO Device Support Models and Simulation Target Functions* for the simulation target functions.



### 3.2.10. Transferring the Programs to the CPU Unit and Servo Drive

You transfer the programs and parameter settings to the physical NJ-series CPU Unit and Servo Drive.

1 Select **Online** from the Controller Menu.

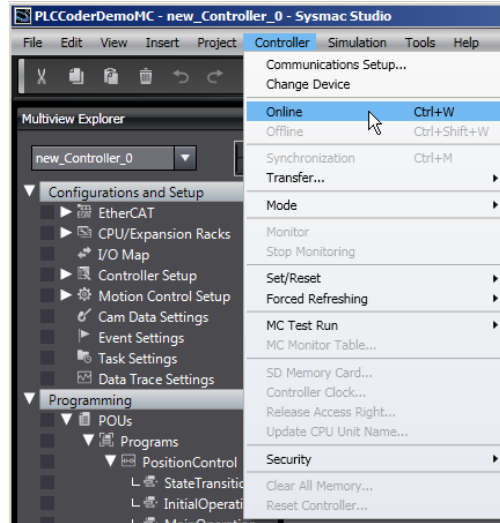

2 Select **Transfer - To Controller** from the Controller Menu.

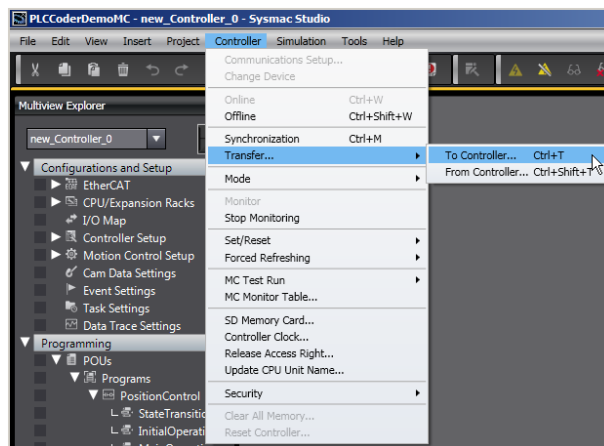

3 Clear the selection of the *Don't transfer the following.* (All items are not transferred.) Check Box.

Click the **Execute** Button.

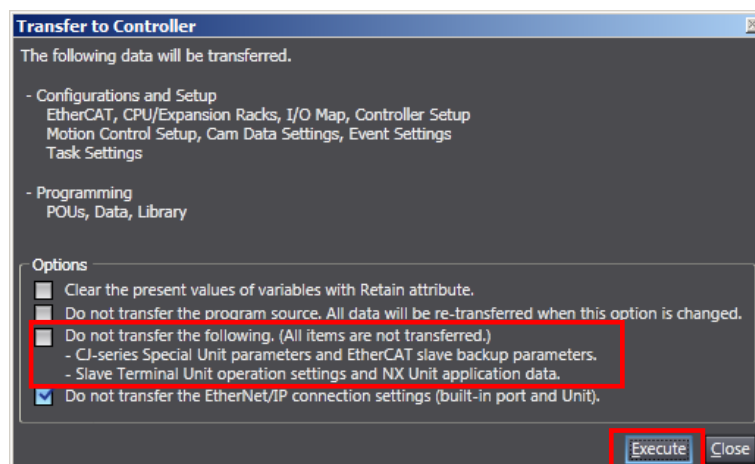

### 3.2.11. Transferring Screen Data to Programmable Terminal

You transfer the screen data that you created to the physical Programmable Terminal.

- 1 Select **Online** from the HMI Menu of the Sysmac Studio.

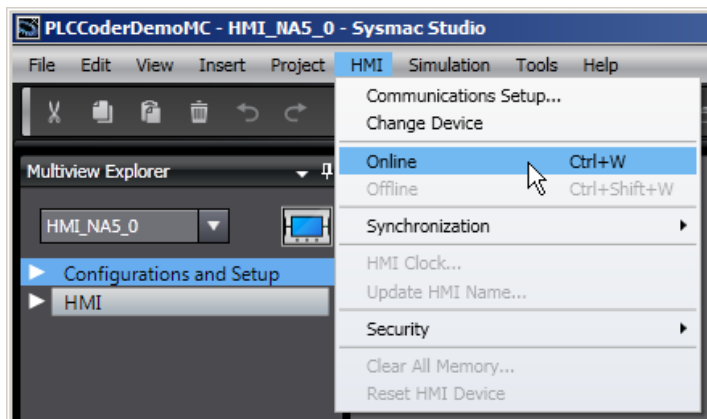

- 2 Select **Synchronization – NA Device** from the HMI Menu of the Sysmac Studio.

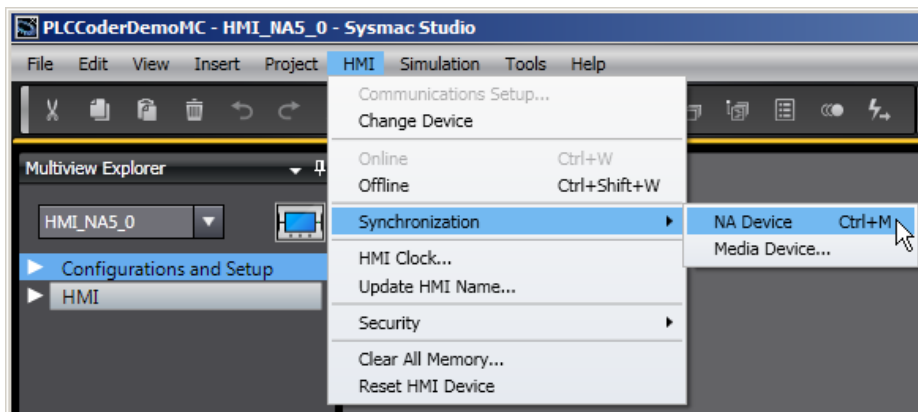

- 3 Click the **Transfer to Device** Button in the Synchronization Window.

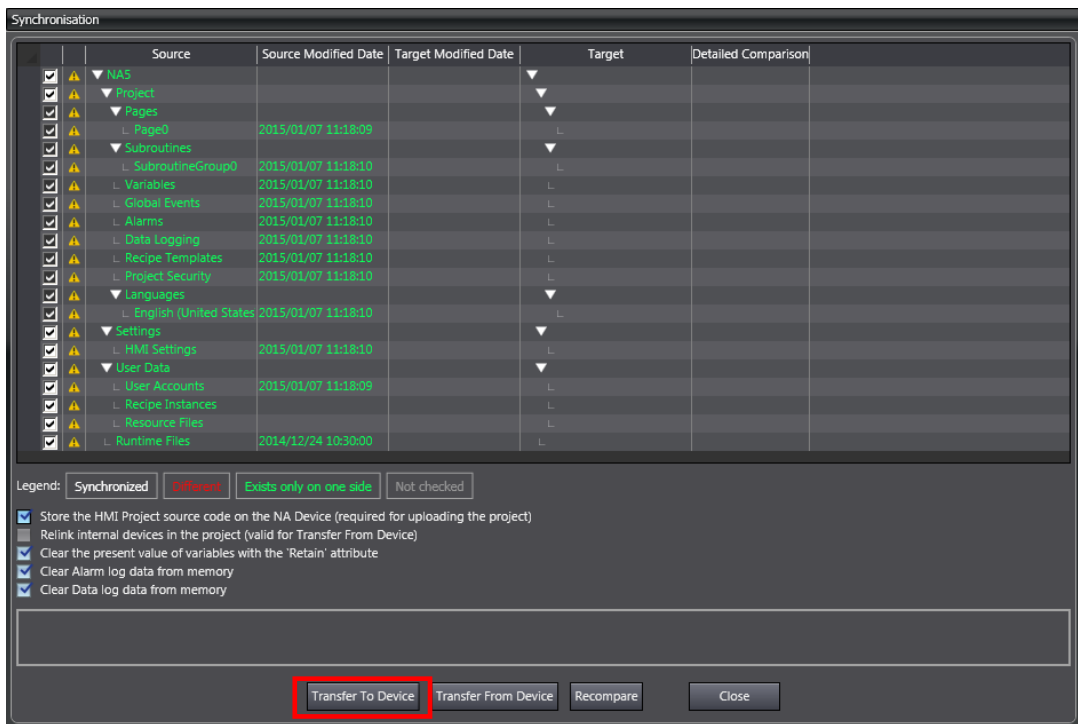

### 3.2.12. System Operation Check

You execute the operation according to the programs transferred to the physical device and check the operation by comparing it with the simulation results using the function for data acquisition from the NJ-series CPU Unit to the Simulink.

This function can be used when the data are synchronized between the Sysmac Studio and the NJ-series CPU Unit.



#### Precautions for Correct Use

The physical motor will run. Thoroughly read and understand the manuals for all devices that make up the system to ensure that the system is used safely. Review the entire contents of these manuals, including all safety precautions, precautions for safe use, and precautions for correct use before the actual operation.

1 Select **Online** from the Controller Menu of the Sysmac Studio.

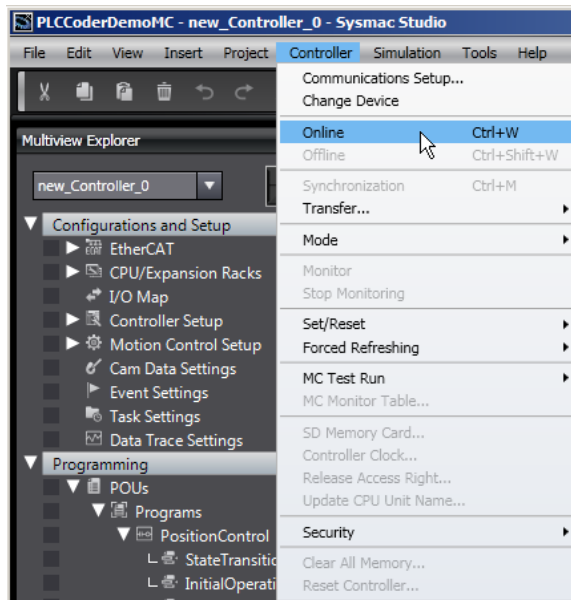

2 Select **Synchronization** from the Controller Menu of the Sysmac Studio.

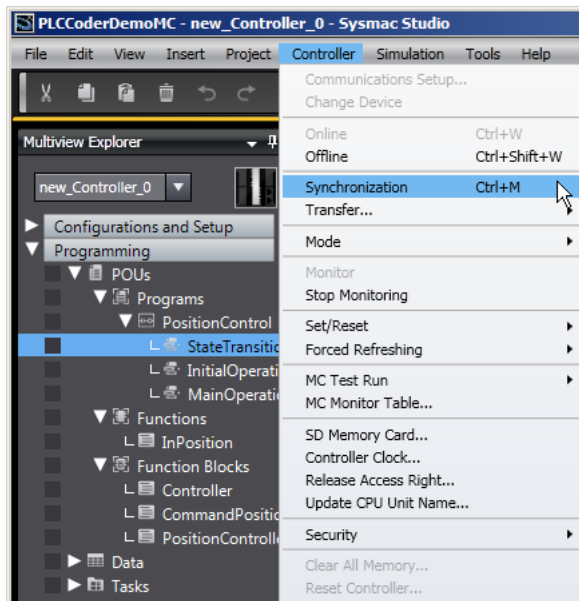

- 3 Confirm that the data are already synchronized in the Synchronization Window and click the **Close** Button.

The Synchronization window displays a comparison of data between two controllers. The window is titled "Synchronization" and contains a table with columns for "Computer: Data Name", "Computer: Update Date", "Controller: Update Date", "Controller: Data Name", and "Compare". The table lists various system components such as EtherCAT, CPU/Expansion Racks, CPU Rack, Units, Controller Setup, Operation Settings, Built-in EtherNet/IP Port, Motion Control Setup, Axis Settings, Axes Group Settings, Cam Data Settings, Event Settings, Task Settings, POU, Programs, PositionControl, Variables, StateTransition, InitialOperation, MainOperation, Functions, InPosition, and Variables. The "Compare" column shows the status of each item, with "Synchronized" items having a green checkmark. Below the table is a legend with four categories: "Synchronized" (green checkmark), "Different" (red X), "Exists only on one side" (yellow exclamation mark), and "Not checked" (grey square). There are also several checkboxes for transfer options: "Clear the present values of variables with Retain attribute (Valid for Transfer to Controller)", "Do not transfer the program source (Valid for Transfer to Controller). All data will be re-transferred when this option is changed.", "Do not transfer the following. (All items are not transferred.)" (with sub-items for CJ-series Special Unit parameters and EtherCAT slave backup parameters, and Slave Terminal Unit operation settings and NX Unit application data), and "Do not transfer the EtherNet/IP connection settings (built-in port and Unit)". At the bottom of the window are four buttons: "Transfer To Controller", "Transfer From Controller", "Recompare", and "Close". The "Close" button is highlighted with a red box.

- 4 Click the  Button in the Controller Status Pane.

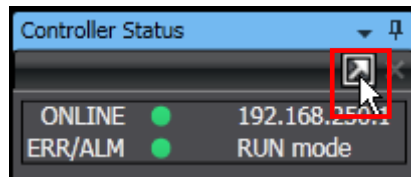

- 5 Confirm that *Synchronized* is displayed in the detailed view of controller status.

The Controller Status Details window shows the detailed view of the controller status. It displays "Normal communications" with a green dot and "No Controller error" with a green dot. The "RUN mode" status is highlighted with a red box. Below this, the IP address is "192.168.250.1", Subnet mask is "255.255.255.0", Operation authority is "Unused", Primary periodic task execution time is "282.560 us", Primary period is "1000.000 us", EtherNet/IP Tag Data Link is "One or more connections are stopped, or no connection setting.", EtherCAT Process Data Communications is "Communicating", Serial ID is "R01-29713-4218", and Variable in Forced Refreshing is "None". Below this is a table titled "List of Controllers Connected Online" with columns for "CPU Unit name", "IP address", "Communications", "Operating mode", "Controller error", and "User-defined error". The table shows "new\_Controller\_0" with IP address "192.168.250.1", Normal communications, RUN mode, No Controller error, and No user-defined error.

- 6 Open the Simulink model file that you used in 3.2.9. *Debugging by Simulation* or the separately provided the *Sample File No. 6 SILSDemoMC.mdl* on the Simulink.

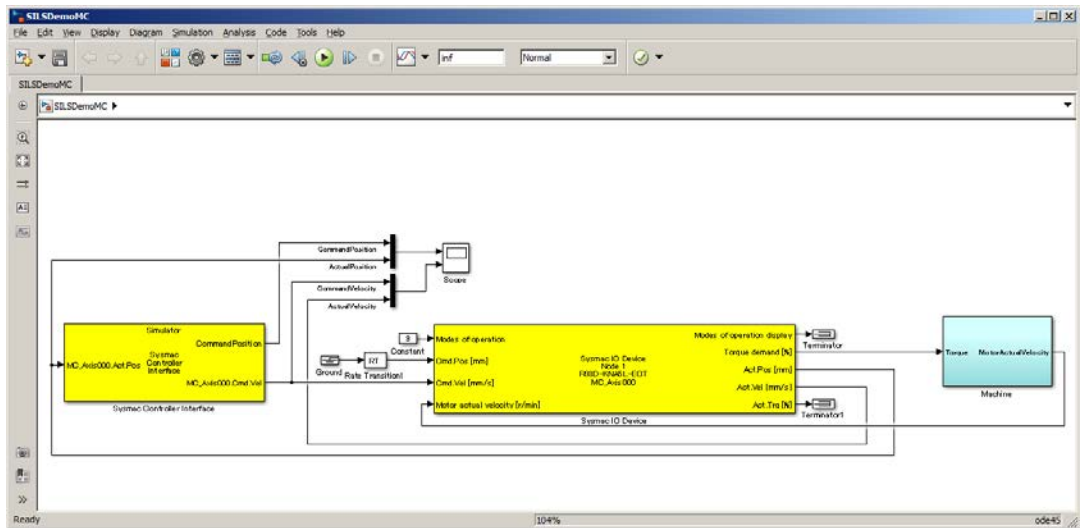

- 7 Double-click the Sysmac Controller Interface block. The setting dialog box for exchanging the data between Simulink and Sysmac Studio is displayed.

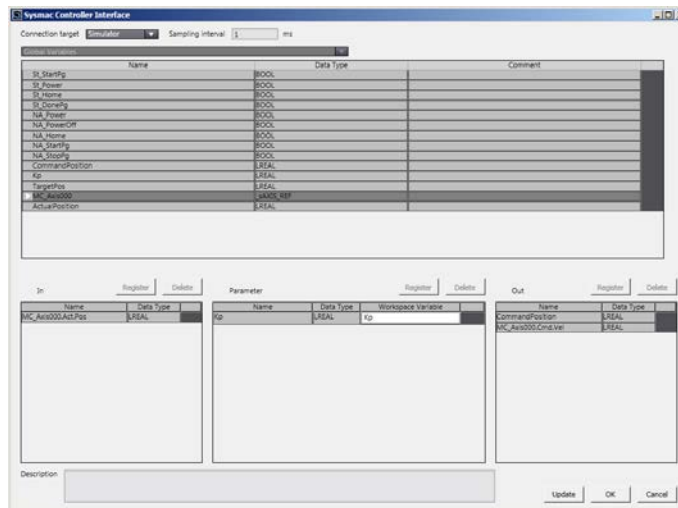

- 8 Select *Controller* for the connection target to get the Controller data.

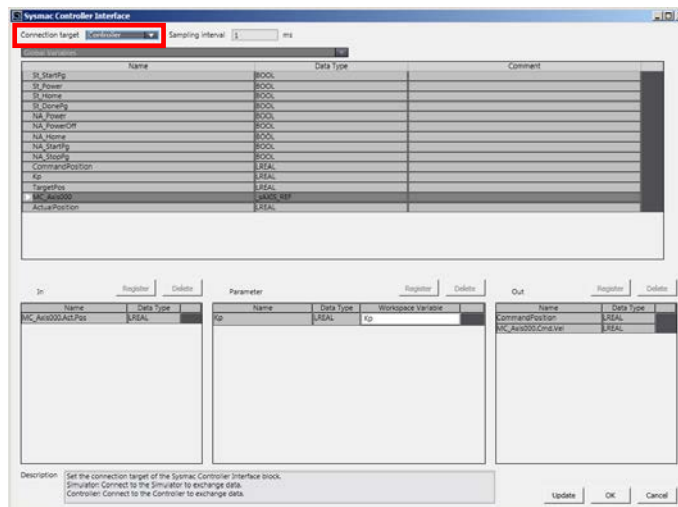

- 9 Because the In list is not used, delete the variable in the list.  
Select *MC\_Axis000.Act.Pos* and click the **Delete** Button.

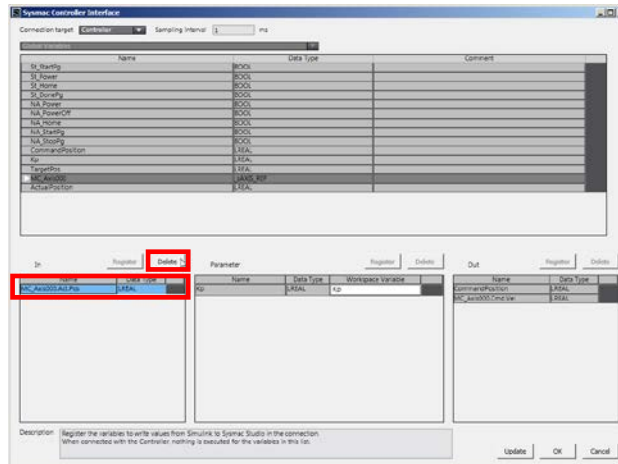

- 10 In order to pass the actual current position and actual current velocity of the NJ-series CPU Unit to the Simulink, select *MC\_Axis000.Act.Pos* and *MC\_Axis000.Act.Vel* from the list of variables in the Sysmac Studio project and click the **Register** Button for the Out list.

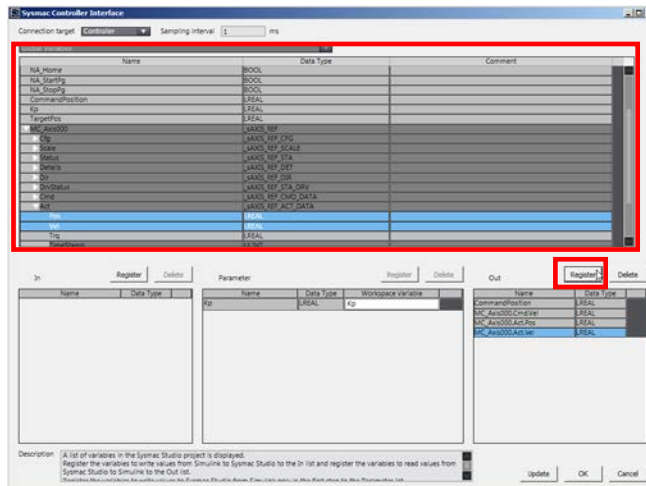

- 11 Click the **OK** Button to close the dialog box.

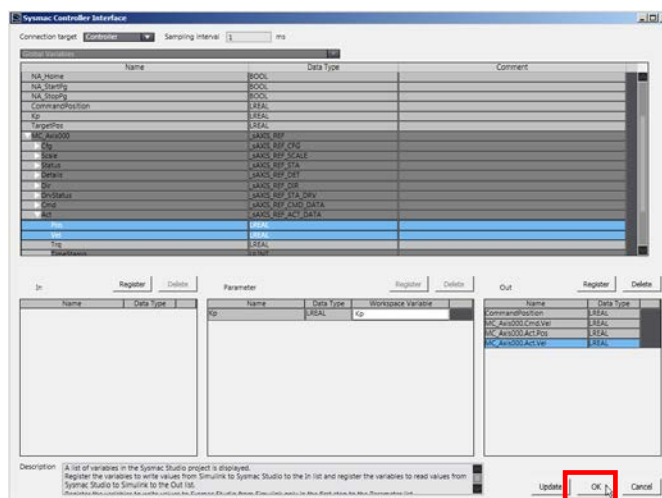

- 12 Connect the output signal lines from the Sysmac Controller Interface block to the Scope block. By keeping *MC\_Axis000.Cmd.Vel* connected with the Sysmac IO Device block, the value of the *MC\_Axis000.Cmd.Vel* of the NJ-series CPU Unit is used in the simulation.

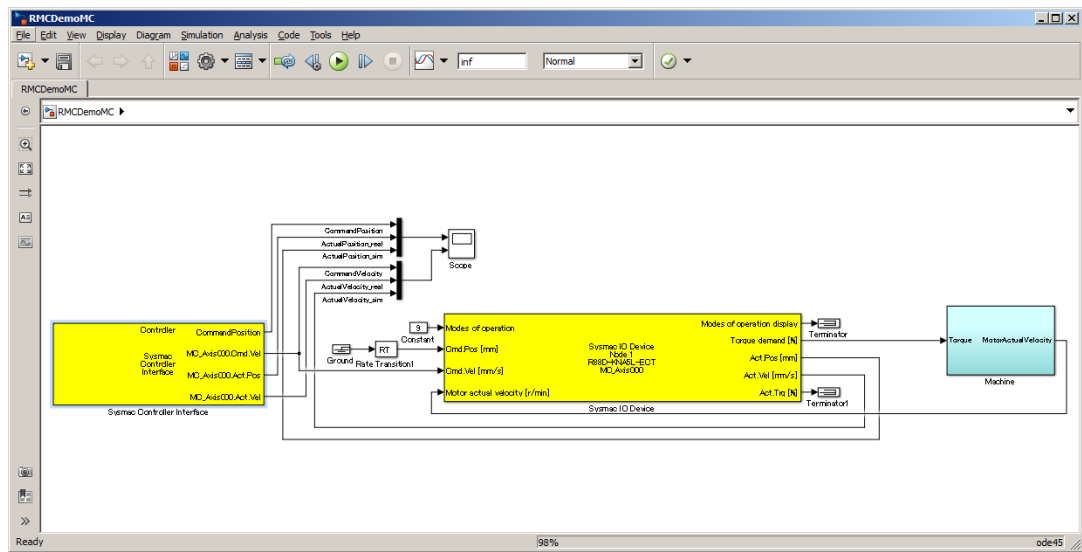

- 13 Select **Run** from the Simulation Menu of the Simulink.

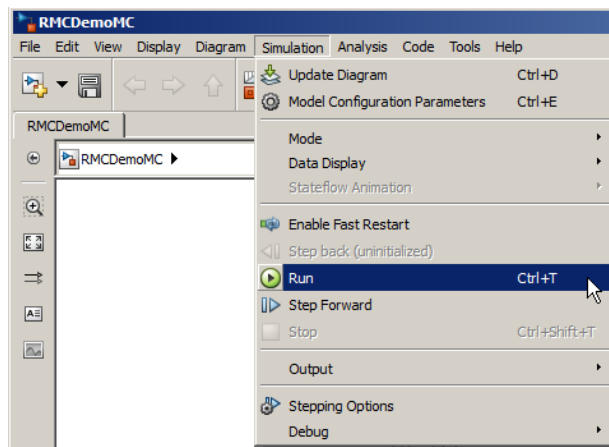

- 14 Click the **Yes** Button in the Sysmac Controller Interface Dialog Box. The value of the  $K_p$  workspace variable of the MATLAB (10 in the Sample File No. 9) is written to the  $K_p$  variable of the Controller.

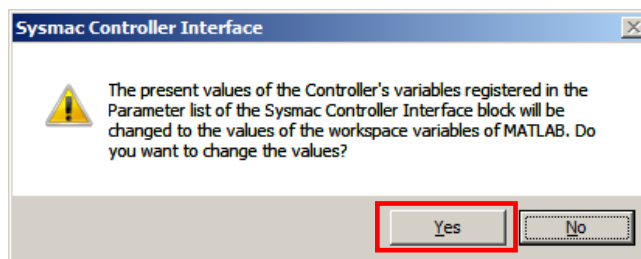

- 15 Press the **Power ON** Button on the physical Programmable Terminal.  
The Servo is turned ON and the **Ready** Lamp is lit.

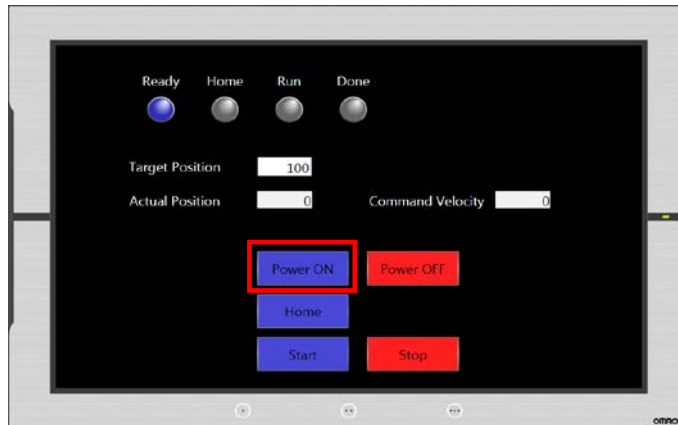

- 16 Press the **Home** Button on the physical Programmable Terminal.  
The axis is returned to the home.

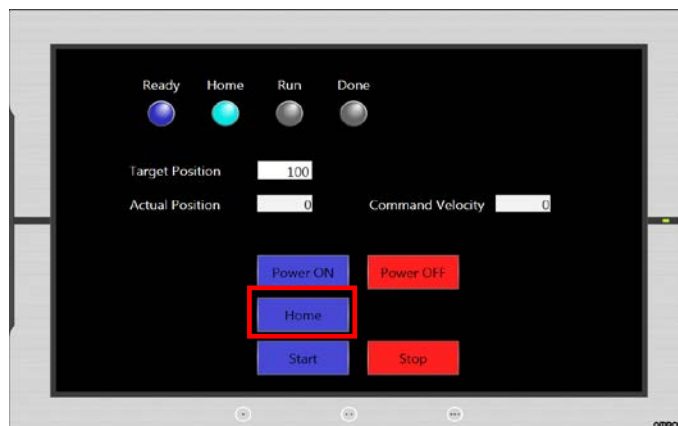

- 17 Press the **Start** Button on the physical Programmable Terminal.  
The axis starts moving to the Target Position and the **Run** Lamp is lit.  
The Actual Position value and Command Velocity value change.  
When the movement is completed, the **Done** Lamp is lit.

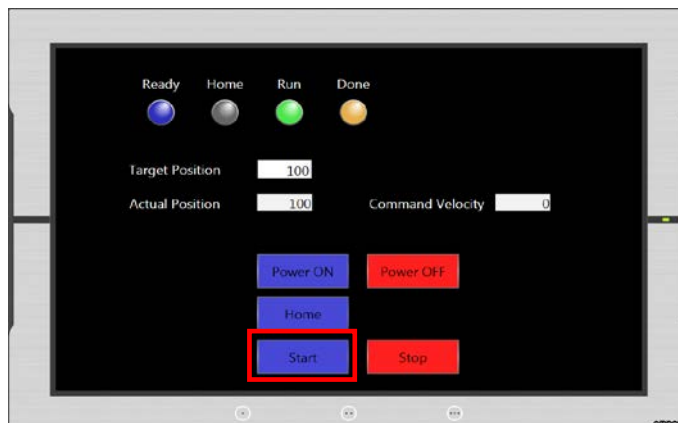



- 18 Check the simulation results (Scope) of the Simulink. You can confirm that you got the similar results as the waveform shown in 1.2. *The Servo System Constructed in this Guide* and 2.2. *Designing the Control Algorithm*.

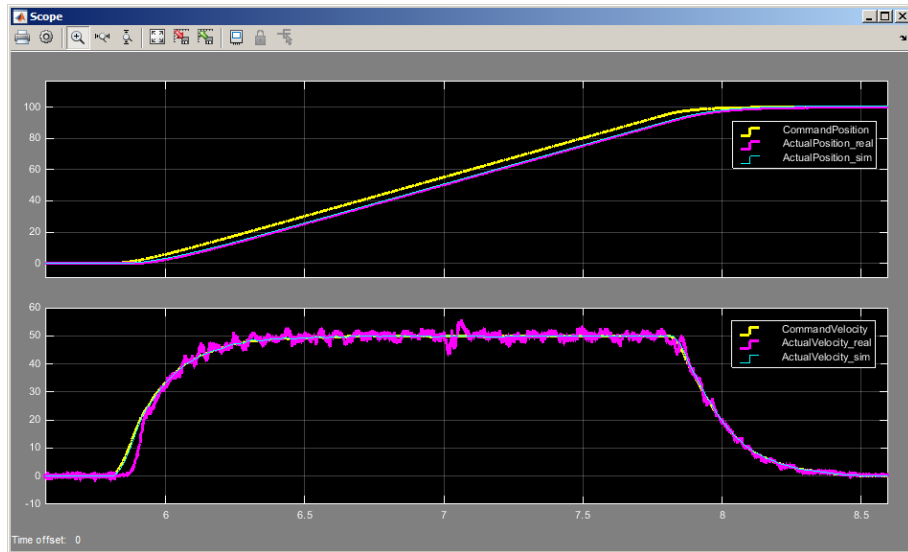

- 19 Use the following procedure to stop the simulation (i.e. monitoring on the Simulink). Select **Stop** from the Simulation Menu of the Simulink.

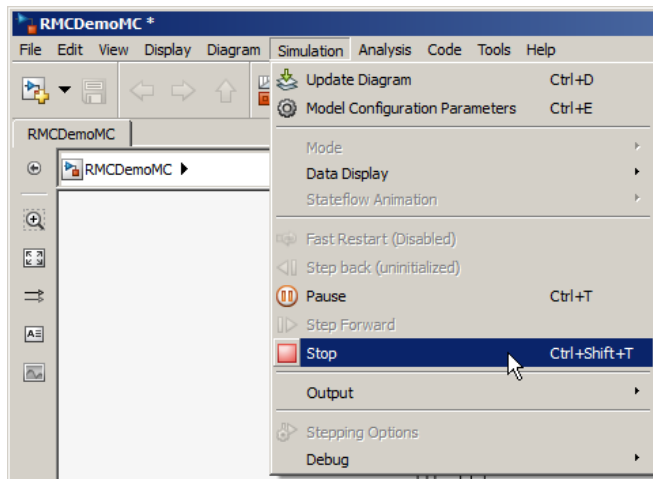

#### Additional Information

- Refer to the *Sample File No. 7 RMC DemoMC.mdl* for the Simulink model created above.
- Perform either of the following operations to change the value of the MATLAB workspace variable to adjust the parameter.
  - ✧ Set the Retain attribute for the variable on the Sysmac Studio in advance.
  - ✧ After the adjustment, change the initial value of the variable to the new value on the Sysmac Studio and send the data to the Controller again.

The present values of non-retained variables will change to their initial values when the power supply to the CPU Unit is turned ON, when the operation mode is changed, and after data download from the Sysmac Studio.

# 4. Appendix

## 4.1. Programming in Ladder Diagram Language

To call a function block from a program written in the ladder diagram language, the function block must have at least one BOOL input variable and one BOOL output variable.

This section describes the procedure for adding boolean signals to the block on the Simulink.



### Additional Information

You also can add BOOL variables on the Sysmac Studio after importing the code without changing the block on the Simulink.

1 Add boolean signals to the Controller block on the Simulink.

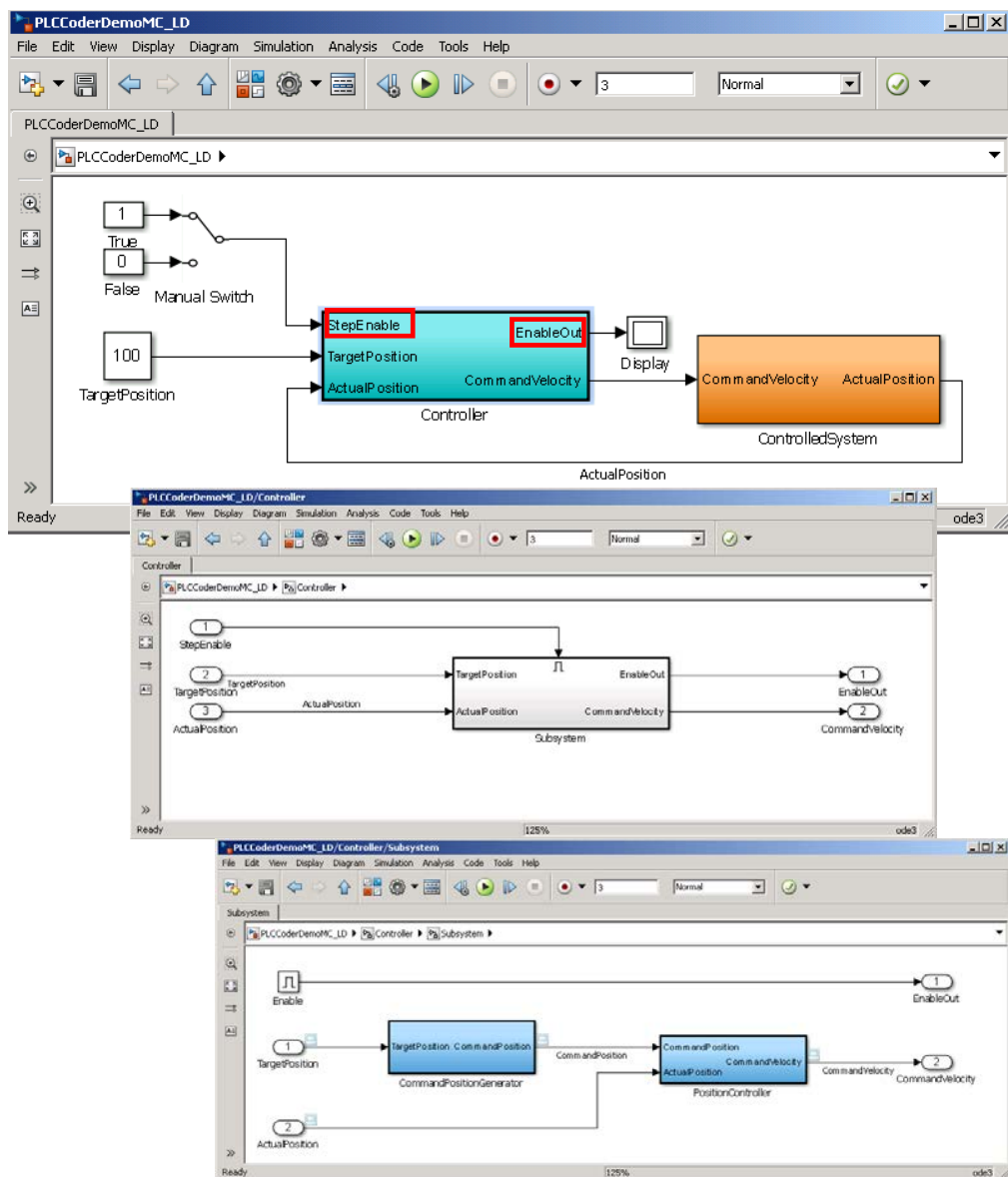

- 2 When the code is imported to the Sysmac Studio, the BOOL variables are added as shown below.

Controller X			
Variables			
Namespace - Using			
	Name	In/Out	Data Type
In/Out	ssMethodType	Input	SINT
Externals	StepEnable	Input	BOOL
	TargetPosition	Input	LREAL
	ActualPosition	Input	LREAL
	EnableOut	Output	BOOL
	CommandVelocity	Output	LREAL

- 3 The program to call the function block is written in the ladder diagram language as shown below.

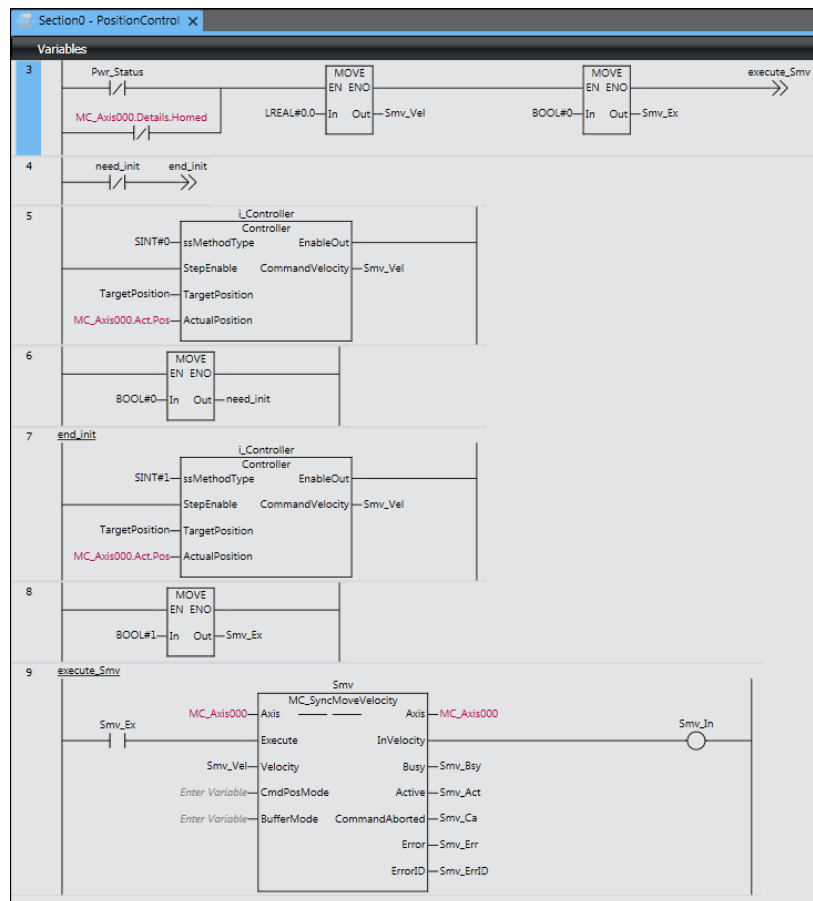

### Additional Information

Refer to the *Sample File No. 8 PLCCoderDemoMC\_LD.mdl* that is provided separately for the Simulink model used in this section.

Refer to the *Sample File No. 9 PLCCoderDemoMC\_LD.smc2* that is provided separately for the program used in this section.

## 4.2. Sysmac IO Device Support Models and Simulation Target Functions

The following models can be selected for Sysmac IO Device.

No.	Category	Target Model	
1	Servo Drive	AC Servo Drives [G5-series Servo Drives with EtherCAT communications]	R88D-KN□-ECT
		AC Servo Drives [G5-series Linear Servo Drives with EtherCAT communications]	R88D-KN□-ECT-L
2	Servo Drive	AC Servo Drives [1S-series Servo Drives with EtherCAT communications]	R88D-1SN□-ECT
3	Analog Input	GX-series EtherCAT Remote I/O Terminal	GX-AD0471
		NX-series EtherCAT Slave Terminals	NX-AD□□□□
4	Analog Output	GX-series EtherCAT Remote I/O Terminal	GX-DA0271
		NX-series EtherCAT Slave Terminals	NX-DA□□□□

### (1) Simulation Target Functions of Servo Drives (G5-series)

The control mode is switched between position control mode and velocity control mode by specifying 8: *Cyclic synchronous position mode (csp)* or 9: *Cyclic synchronous velocity mode (csv)* in the *Modes of operation* input to the Sysmac IO Device block.

Torque control mode and control mode change during simulation are not supported.

Function	No.	Name
Smoothing filter (first-order lag filter)	Pn222	Position Command Filter Time Constant
Damping control	Pn213	Damping Filter Selection (Only "0" is supported. Even if other value is set, it operates as if "0" is set.)
	Pn214	Damping Frequency 1
	Pn215	Damping Filter 1 Setting
	Pn216	Damping Frequency 2
	Pn217	Damping Filter 2 Setting
Speed Feed-forward	Pn110	Speed Feed-forward Gain
	Pn111	Speed Feed-forward Command Filter
Gain switching (Only "Always gain 1" and "Always gain 2" are supported.)	Pn114	Gain Switching Input Operation Mode Selection
	Pn115	Switching Mode in Position Control (Only "0", "1", and "4" are supported. If other value is set, it operates as if "0: Always gain 1" is set.)
	Pn120	Switching Mode in Speed Control (Only "0" and "1" are supported. If other value is set, it operates as if "0: Always gain 1" is set.)
Position control	Pn100	Position Loop Gain 1
	Pn105	Position Loop Gain 2
Speed control	Pn101	Speed Loop Gain 1
	Pn106	Speed Loop Gain 2
	Pn102	Speed Loop Integral Time Constant 1
	Pn107	Speed Loop Integral Time Constant 2
	Pn004	Inertia Ratio

Function	No.	Name
Notch filter	Pn201	Notch 1 Frequency Setting
	Pn202	Notch 1 Width Setting
	Pn203	Notch 1 Depth Setting
	Pn204	Notch 2 Frequency Setting
	Pn205	Notch 2 Width Setting
	Pn206	Notch 2 Depth Setting
	Pn207	Notch 3 Frequency Setting
	Pn208	Notch 3 Width Setting
	Pn209	Notch 3 Depth Setting
	Pn210	Notch 4 Frequency Setting
	Pn211	Notch 4 Width Setting
	Pn212	Notch 4 Depth Setting
Torque (Force) filter	Pn104	Torque (Force) Command Filter Time Constant 1
	Pn109	Torque (Force) Command Filter Time Constant 2
Torque (Force) limit	Pn753	External Torque (Force) Limit 1 (PDO: 3013 hex)
	Pn754	External Torque (Force) Limit 2 (PDO: 3522 hex)
	Axis setting	Positive Torque Limit (PDO: 60E0 hex)
	Axis setting	Negative Torque Limit (PDO: 60E1 hex)
Unit conversion settings	Axis setting	Command pulse count per motor rotation
	Axis setting	Work travel distance per motor rotation
	Axis setting	Unit of display

## (2) Simulation Target Functions of Servo Drives (1S-series)

The control mode is switched between position control mode, velocity control mode, and torque control mode by specifying 8: *Cyclic synchronous position mode (csp)*, 9: *Cyclic synchronous velocity mode (csv)*, or 10: *Cyclic synchronous torque mode (cst)* in the *Modes of operation* input to the Sysmac IO Device block.

Torque control mode and control mode change during simulation are not supported.

Function	OD	Name
Basic Functions	3000.03	Control Method Selection
Machine	3001.01	Inertia Ratio
Position Command Filter	3011.01	FIR Filter Enable
	3011.02	FIR Filter Moving Average Time
	3011.03	IIR Filter Enable
	3011.04	IIR Filter Cutoff Frequency
Damping Control	3012.01	Damping Filter 1 Selection
	3012.02	Damping Filter 2 Selection
Damping Filter 1	3013.01	1st Frequency
	3013.02	1st Damping Time Coefficient
	3013.03	2nd Frequency
	3013.04	2nd Damping Time Coefficient
	3013.05	3rd Frequency
	3013.06	3rd Damping Time Coefficient
	3013.07	4th Frequency
	3013.08	4th Damping Time Coefficient
Damping Filter 2	3014.01	1st Frequency
	3014.02	1st Damping Time Coefficient
	3014.03	2nd Frequency
	3014.04	2nd Damping Time Coefficient
	3014.05	3rd Frequency
	3014.06	3rd Damping Time Coefficient
	3014.07	4th Frequency
	3014.08	4th Damping Time Coefficient
Velocity Command Filter	3021.03	IIR Filter Enable
	3021.04	Filter Cutoff Frequency
Velocity Limit in Torque Control	3031.01	Velocity Limit Value
ODF Velocity Feed-forward	3112.01	Gain
	3112.02	LPF Enable
	3112.03	LPF Cutoff Frequency
ODF Torque Feed-forward	3113.01	Gain
	3113.02	LPF Enable
	3113.03	LPF Cutoff Frequency
TDF Position Control	3120.01	Command Following Gain
	3120.10	Command Following Gain Selection
	3120.11	Command Following Gain 2

Function	OD	Name
Speed Detection Function	3B60.04	Excessive Speed Detection Level
TDF Velocity Control	3121.01	Command Following Gain
	3121.10	Command Following Gain Selection
	3121.11	Command Following Gain 2
TDF Velocity Feed-forward	3122.01	Gain
TDF Torque Feed-forward	3123.01	Gain
Gain Switching in Position Control	3212.01	Mode Selection (Only "0" and "1" are supported. If other value is set, it operates as if "0: Always gain 1" is set.)
1st Position Control Gain	3213.01	Proportional Gain
2nd Position Control Gain	3214.01	Proportional Gain
Gain Switching in Velocity Control	3222.01	Mode Selection (Only "0" and "1" are supported. If other value is set, it operates as if "0: Always gain 1" is set.)
1st Velocity Control Gain	3223.01	Proportional Gain
	3223.02	Integral Gain
2nd Velocity Control Gain	3224.01	Proportional Gain
	3224.02	Integral Gain
Filter Switching in Torque Control	3232.01	Mode Selection (Only "0" and "1" are supported. If other value is set, it operates as if "0: Always 1st Filter" is set.)
1st Torque Command Filter	3233.01	Enable
	3233.02	Cutoff Frequency
2nd Torque Command Filter	3234.01	Enable
	3234.02	Cutoff Frequency
Torque Compensation	3310.01	Viscous Friction Coefficient
	3310.02	Unbalanced Load Compensation
	3310.03	Positive Dynamic Friction Compensation
	3310.04	Negative Dynamic Friction Compensation
1st Notch Filter	3321.01	Enable
	3321.02	Frequency
	3321.03	Q-value
	3321.04	Depth
2nd Notch Filter	3322.01	Enable
	3322.02	Frequency
	3322.03	Q-value
	3322.04	Depth
3rd Notch Filter	3323.01	Enable
	3323.02	Frequency
	3323.03	Q-value
	3323.04	Depth

Function	OD	Name
4th Notch Filter	3324.01	Enable
	3324.02	Frequency
	3324.03	Q-value
	3324.04	Depth
Torque Limit	3330.01	Switching Selection (Only "0" is supported. Even if other value is set, it operates as if "0" is set.)
	3330.02	Max Torque
	Axis setting	Positive Torque Limit (PDO: 60E0 hex)
	Axis setting	Negative Torque Limit (PDO: 60E1 hex)
Unit conversion settings	Axis setting	Command pulse count per motor rotation
	Axis setting	Work travel distance per motor rotation
	Axis setting	Unit of display

### (3) Simulation Target Functions of Analog Input

- GX-series EtherCAT Remote I/O Terminal

Function	Index	Name
Available channel	0x3100:00	Analog Input Available Channel Choice
Range	0x3101:01-04	Analog Input Range
Moving average	0x3132:01-04	Analog Input Moving Average

- NX-series EtherCAT Slave Terminals

Function	Index	Name
Available channel	0x5002:01-08	Ch1-8 Enabled/Disabled
Range	0x5003:01-08	Ch1-8 Range Setting
Moving average	0x5004:01-08	Ch1-8 Input Moving Average Time

### (4) Simulation Target Functions of Analog Output

- GX-series EtherCAT Remote I/O Terminal

Function	Index	Name
Available channel	0x3200:00	Analog Output Available Channel Choice
Range	0x3201:01-02	Analog Output Range

- NX-series EtherCAT Slave Terminal

Function	Index	Name
Available channel	0x5010:01-04	Ch1-4 Enabled/Disabled
Range	0x5011:01-04	Ch1-4 Range Setting





**OMRON Corporation Industrial Automation Company**

Tokyo, JAPAN

Contact: [www.ia.omron.com](http://www.ia.omron.com)

**Regional Headquarters**

**OMRON EUROPE B.V.**

Wegalaan 67-69, 2132 JD Hoofddorp  
The Netherlands  
Tel: (31)2356-81-300/Fax: (31)2356-81-388

**OMRON ELECTRONICS LLC**

2895 Greenspoint Parkway, Suite 200  
Hoffman Estates, IL 60169 U.S.A  
Tel: (1) 847-843-7900/Fax: (1) 847-843-7787

**OMRON ASIA PACIFIC PTE. LTD.**

No. 438A Alexandra Road # 05-05/08 (Lobby 2),  
Alexandra Technopark,  
Singapore 119967  
Tel: (65) 6835-3011/Fax: (65) 6835-2711

**OMRON (CHINA) CO., LTD.**

Room 2211, Bank of China Tower,  
200 Yin Cheng Zhong Road,  
PuDong New Area, Shanghai, 200120, China  
Tel: (86) 21-5037-2222/Fax: (86) 21-5037-2200

**Authorized Distributor:**

© OMRON Corporation 2016 All Rights Reserved.  
In the interest of product improvement,  
specifications are subject to change without notice.

**Cat. No. W529-E1-05**

0317(0613)