

## Machine Automation Controller NJ/NX-series

### Motion Control Instructions Reference Manual

NX701-1□□□

NX502-1□□□

NX102-1□□□

NX102-90□□

NX1P2-1□□□□□

NX1P2-9□□□□□

NJ501-□□□□



NJ301-1□□□

NJ101-10□□

## NOTE

1. All rights reserved. No part of this publication may be reproduced, stored in a retrieval system, or transmitted, in any form, or by any means, mechanical, electronic, photocopying, recording, or otherwise, without the prior written permission of OMRON.
2. No patent liability is assumed with respect to the use of the information contained herein.  
Moreover, because OMRON is constantly striving to improve its high-quality products, the information contained in this manual is subject to change without notice.
3. Every precaution has been taken in the preparation of this manual. Nevertheless, OMRON assumes no responsibility for errors or omissions.  
Neither is any liability assumed for damages resulting from the use of the information contained in this publication.

## Trademarks

- Sysmac and SYSMAC are trademarks or registered trademarks of OMRON Corporation in Japan and other countries for OMRON factory automation products.
- Microsoft, Windows, Excel, Visual Basic and Microsoft Edge are either registered trademarks or trademarks of Microsoft Corporation in the United States and other countries.
- EtherCAT® is registered trademark and patented technology, licensed by Beckhoff Automation GmbH, Germany.
- ODVA, CIP, CompoNet, DeviceNet, and EtherNet/IP are trademarks of ODVA.
- The SD and SDHC logos are trademarks of SD-3C, LLC.  

Other company names and product names in this document are the trademarks or registered trademarks of their respective companies.

## Copyrights

- Microsoft product screen shots used with permission from Microsoft.
- This product incorporates certain third party software. The license and copyright information associated with this software is available at [http://www.fa.omron.co.jp/nj\\_info\\_e/](http://www.fa.omron.co.jp/nj_info_e/).

# Introduction

---

Thank you for purchasing an NJ/NX-series CPU Unit.

This manual describes the motion control instructions. Please be sure you sufficiently understand the operations and handling procedures, and use the Motion Control Function Module (abbreviated as “MC Function Module”) correctly.

Use this manual together with the user’s manuals for the NJ/NX-series CPU Unit.

When you have finished reading this manual, keep it in a safe location where it will be readily available for future use.

## Intended Audience

This manual is intended for the following personnel, who must also have knowledge of electrical systems (an electrical engineer or the equivalent).

- Personnel in charge of introducing FA systems.
- Personnel in charge of designing FA systems.
- Personnel in charge of installing and maintaining FA systems.
- Personnel in charge of managing FA systems and facilities.

For programming, this manual is intended for personnel who understand the programming language specifications in international standard IEC 61131-3 or Japanese standard JIS B 3503.

## Applicable Products

This manual covers the following products.

- NX-series CPU Units
  - NX701-1□□□
  - NX502-1□□□
  - NX102-1□□□
  - NX102-90□□
  - NX1P2-1□□□□□
  - NX1P2-9□□□□□
- NJ-series CPU Units
  - NJ501-□□□□
  - NJ301-1□□□
  - NJ101-10□□

Part of the specifications and restrictions for the CPU Units are given in other manuals. Refer to *Relevant Manuals* on page 2 and *Related Manuals* on page 24.

# Relevant Manuals

The following table provides the relevant manuals for the NJ/NX-series CPU Units. Read all of the manuals that are relevant to your system configuration and application before you use the NJ/NX-series CPU Unit.

Most operations are performed from the Sysmac Studio Automation Software. Refer to the *Sysmac Studio Version 1 Operation Manual (Cat. No. W504)* for information on the Sysmac Studio.

Purpose of use	Manual												
	Basic information						NJ/NX-series Motion Control Instructions Reference Manual	NJ/NX-series CPU Unit Motion Control User's Manual	NJ/NX-series Instructions Reference Manual	NJ/NX-series NX1P2 CPU Unit Built-in I/O and Option Board User's Manual	NJ/NX-series CPU Unit Software User's Manual	NJ-series CPU Unit Hardware User's Manual	NX-series NX1P2 CPU Unit Hardware User's Manual
	NX-series NX102 CPU Unit Hardware User's Manual	NX-series NX502 CPU Unit Hardware User's Manual	NX-series CPU Unit Hardware User's Manual	NJ-series Robot Integrated CPU Unit User's Manual	NJ-series NJ Robotics CPU Unit User's Manual	NJ/NY-series NC Integrated Controller User's Manual							
Introduction to NX701 CPU Units	<input type="checkbox"/>												
Introduction to NX502 CPU Units	<input type="checkbox"/>												
Introduction to NX102 CPU Units		<input type="checkbox"/>											
Introduction to NX1P2 CPU Units			<input type="checkbox"/>										
Introduction to NJ-series Controllers				<input type="checkbox"/>									
Setting devices and hardware													
Using motion control							<input type="checkbox"/>						
Using EtherCAT	<input type="checkbox"/>	<input type="checkbox"/>	<input type="checkbox"/>	<input type="checkbox"/>	<input type="checkbox"/>				<input type="checkbox"/>				
Using EtherNet/IP									<input type="checkbox"/>				
Using robot control for OMRON robots											<input type="checkbox"/>		

Purpose of use	Manual											
	Basic information											
	NJ/NX-series Troubleshooting Manual	NJ/NY-series NC Integrated Controller User's Manual	NJ-series NJ Robotics CPU Unit User's Manual	NJ-series Robot Integrated CPU Unit User's Manual	NJ-series SECS/GEM CPU Units User's Manual	NJ/NX-series Database Connection CPU Units User's Manual	NX-series CPU Unit FINS User's Manual	NJ/NX-series CPU Unit OPC UA User's Manual	NJ/NX-series CPU Unit Built-in EtherNet/IP Port User's Manual	NJ/NX-series CPU Unit Built-in EtherCAT Port User's Manual	NJ/NX-series Motion Control Instructions Reference Manual	NJ/NX-series CPU Unit Motion Control User's Manual
Software settings												
Using motion control												
Using EtherCAT												
Using EtherNet/IP												
Using OPC UA												
Using FINS												
Using the database connection service												
Using the GEM Services												
Using robot control for OMRON robots												
Using robot control by NJ Robotics function												
Using numerical control												
Using the NX1P2 CPU Unit functions												
Writing the user program												
Using motion control												
Using EtherCAT												
Using EtherNet/IP												
Using OPC UA												
Using FINS												
Using the database connection service												
Using the GEM Services												
Using robot control for OMRON robots												
Using robot control by NJ Robotics function												
Using numerical control												
Programming error processing												
Using the NX1P2 CPU Unit functions												

Purpose of use	Manual													
	Basic information					NJ/NX-series Motion Control Instructions Reference Manual	NJ/NX-series Motion Control User's Manual	NJ/NX-series CPU Unit	NJ/NX-series CPU Unit	NJ/NX-series CPU Unit	NJ/NX-series CPU Unit	NJ/NX-series CPU Unit	NJ/NX-series CPU Unit	NJ/NX-series CPU Unit
	NJ/NX-series CPU Unit Software User's Manual	NJ-series CPU Unit Hardware User's Manual	NX-series NX1P2 CPU Unit Hardware User's Manual	NX-series NX102 CPU Unit Hardware User's Manual	NX-series NX502 CPU Unit Hardware User's Manual									
Testing operation and debugging														
Using motion control														
Using EtherCAT														
Using EtherNet/IP														
Using OPC UA														
Using FINS														
Using the database connection service														
Using the GEM Services														
Using robot control for OMRON robots														
Using robot control by NJ Robotics function														
Using numerical control														
Using the NX1P2 CPU Unit functions														
Learning about error management and corrections*1														
Maintenance														
Using motion control														
Using EtherCAT														
Using EtherNet/IP														

\*1. Refer to the *NJ/NX-series Troubleshooting Manual (Cat. No. W503)* for the error management concepts and the error items. However, refer to the manuals that are indicated with triangles for details on errors corresponding to the products with the manuals that are indicated with triangles.

# Manual Structure

## Page Structure

The following page structure is used in this manual.

Level-1 section heading →

Level-2 section heading →

Level-3 section heading →

3 Axis Command Instructions

### MC\_Power

The MC\_Power instruction makes a Servo Drive ready to operate.

Instruction	Name	FB/FUN	Graphic expression	ST expression
MC_Power	Power Servo	FB		MC_Power_instance ( Axis =>parameter, Enable =>parameter, Status =>parameter, Busy =>parameter, Error =>parameter, ErrorID =>parameter );

#### Variables

##### Input Variables

Name	Meaning	Data type	Valid range	Default	Description
Enable	Enable	BOOL	TRUE or FALSE	FALSE	The device is ready for operation when Enable is TRUE, and not ready when it is FALSE.

##### Output Variables

Name	Meaning	Data type	Valid range	Description
Status	Servo ON	BOOL	TRUE or FALSE	TRUE when the device is ready for operation.
Busy	Executing	BOOL	TRUE or FALSE	TRUE when the instruction is acknowledged.
Error	Error	BOOL	TRUE or FALSE	TRUE while there is an error.
ErrorID	Error Code	WORD	*	Contains the error code when an error occurs. A value of 16#0000 indicates normal execution.

\* Refer to A-1 Error Codes.

##### Output Variable Update Timing

Name	Timing for changing to TRUE	Timing for changing to FALSE
Status	When the specified axis becomes ready for operation.	<ul style="list-style-type: none"> <li>When operation ready status for the specified axis is cleared.</li> <li>When Error changes to TRUE.</li> </ul>
Busy	When Enable changes to TRUE.	<ul style="list-style-type: none"> <li>When Enable changes to FALSE.</li> <li>When Error changes to TRUE.</li> </ul>
Error	When there is an error in the execution conditions or input parameters for the instruction.	When the error is cleared.

3-2 NJ-series Motion Control Instructions Reference Manual (W508)

Manual name

3 Axis Command Instructions

**In-Out Variables**

Name	Meaning	Data type	Valid range	Description
Axis	Axis	_SAXIS_REF	---	Specify the axis.

\* Specify an Axis Variable that was created in the Axis Basic Settings of the Sysmac Studio. (The default axis variable names are MC\_Axis\*\*.)

**Function**

- When Enable changes to TRUE, the axis specified by Axis is made ready to operate. You can control the axis when it is ready to operate.
- When Enable changes to FALSE, the ready status is cleared for the axis specified by Axis. You cannot control the axis after the ready status is cleared because it will not acknowledge operation commands. Also, an error occurs if a motion command is executed for an axis for which the ready status is cleared. You can execute the MC\_Power (Power Servo) and MC\_Reset (Reset Axis Error) instructions even for axes that are not ready.
- You can use this instruction to disable the operation of axes while they are in motion. In this case, CommandAborted will change to TRUE. Output of the operation command will stop and the axis will not longer be ready for operation.
- If home is not defined for a Servomotor with an absolute encoder, compensation is performed using the absolute encoder home offset to define home when the axis is ready to operate. For details on the absolute encoder home offset, refer to the *NJ-series CPU Unit Motion Control User's Manual* (Cat. No. W507).

**Precautions for Correct Use**

- You can use this instruction for servo axes and virtual servo axes. If the instruction is used for encoder axes or virtual encoder axes, an error will occur.
- **Executing this instruction for the Master Axis of Synchronized Control**  
When master axis operation is disabled for a vertical axis, the position of the master axis may change rapidly. This may cause the motion of the slave axis to change rapidly. Take suitable measures to prevent the slave axis from moving rapidly, such as applying a brake to the master axis or leaving master axis operation enabled until after synchronized control is completed.

**Timing Charts**

- When Enable changes to TRUE, Busy (Executing) changes to TRUE to indicate that the instruction was acknowledged.
- After the axis becomes ready for operation, Status (Servo ON) changes to TRUE.
- When Enable changes to FALSE, Busy (Executing) changes to FALSE. Status (Servo ON) changes to FALSE when ready status is cleared. Status (Servo ON) outputs the axis ready status regardless of whether Enable is TRUE or FALSE.

Special information  
Icons indicate precautions, additional information, or reference information.



Level-2 section heading  
The level-2 section heading is given.

Level-1 section number  
The level-1 section number is given.

Level-3 section heading  
The level-3 section heading is given.

**Note** These pages are for illustrative purposes only. They may not literally appear in this manual.

## Special Information

Special information in this manual is classified as follows:



### Precautions for Safe Use

Precautions on what to do and what not to do to ensure safe usage of the product.



### Precautions for Correct Use

Precautions on what to do and what not to do to ensure proper operation and performance.



### Additional Information

Additional information to read as required.

This information is provided to increase understanding or make operation easier.



### Version Information

Information on differences in specifications and functionality for Controller with different unit versions and for different versions of the Sysmac Studio is given.



## Precaution on Terminology

In this manual, "download" refers to transferring data from the Sysmac Studio to the physical Controller and "upload" refers to transferring data from the physical Controller to the Sysmac Studio. For the Sysmac Studio, "synchronization" is used to both "upload" and "download" data. Here, "synchronize" means to automatically compare the data for the Sysmac Studio on the computer with the data in the physical Controller and transfer the data in the direction that is specified by the user.



# Sections in this Manual

---

<b>1</b>	<b>Introduction to Motion Control Instructions</b>	<b>1</b>
<b>2</b>	<b>Variables and Instructions</b>	<b>2</b>
<b>3</b>	<b>Axis Command Instructions</b>	<b>3</b>
<b>4</b>	<b>Axes Group Instructions</b>	<b>4</b>
<b>5</b>	<b>Common Command Instructions</b>	<b>5</b>
<b>A</b>	<b>Appendices</b>	<b>A</b>
<b>I</b>	<b>Index</b>	<b>I</b>

# CONTENTS

---

<b>Introduction .....</b>	<b>1</b>
Intended Audience .....	1
Applicable Products .....	1
<b>Relevant Manuals .....</b>	<b>2</b>
<b>Manual Structure .....</b>	<b>5</b>
Page Structure .....	5
Special Information .....	6
Precaution on Terminology .....	7
<b>Sections in this Manual .....</b>	<b>9</b>
<b>Terms and Conditions Agreement .....</b>	<b>16</b>
Warranty, Limitations of Liability .....	16
Application Considerations .....	17
Disclaimers .....	17
Statement of security responsibilities for assumed use cases and against threats .....	18
<b>Safety Precautions .....</b>	<b>19</b>
<b>Precautions for Safe Use .....</b>	<b>20</b>
<b>Precautions for Correct Use .....</b>	<b>21</b>
<b>Regulations and Standards .....</b>	<b>22</b>
<b>Versions .....</b>	<b>23</b>
Unit Versions of CPU Units and Sysmac Studio Versions .....	23
<b>Related Manuals .....</b>	<b>24</b>
<b>Revision History .....</b>	<b>28</b>

## Section 1 Introduction to Motion Control Instructions

---

<b>1-1 Motion Control Instructions .....</b>	<b>1-2</b>
1-1-1 Function Blocks for PLCopen® Motion Control .....	1-2
1-1-2 Overview of Motion Control Instructions .....	1-2
1-1-3 Precautions for Master and Auxiliary Axes in Synchronized Control .....	1-6
<b>1-2 Basic Information on Motion Control Instructions .....</b>	<b>1-9</b>
1-2-1 Motion Control Instruction Names .....	1-9
1-2-2 Languages for Motion Control Instructions .....	1-9
1-2-3 Motion Control Instruction Locations .....	1-10
1-2-4 Multi-execution of Motion Control Instructions .....	1-17
1-2-5 Online Editing of Motion Control Instructions .....	1-18
1-2-6 Changes in the Operating Mode of the CPU Unit .....	1-19

## Section 2 Variables and Instructions

---

<b>2-1 Variables .....</b>	<b>2-2</b>
----------------------------	------------

2-1-1	MC Common Variables .....	2-3
2-1-2	Axis Variables .....	2-4
2-1-3	Axes Group Variables .....	2-10
2-1-4	Input Variables for Motion Control Instructions .....	2-13
2-1-5	Output Variables for Motion Control Instructions .....	2-28
2-1-6	In-Out Variables for Motion Control Instructions .....	2-31
<b>2-2</b>	<b>Instructions .....</b>	<b>2-34</b>
2-2-1	Common Commands .....	2-34
2-2-2	Axis Commands .....	2-35
2-2-3	Axes Group Commands .....	2-37
<b>2-3</b>	<b>PDO Mapping .....</b>	<b>2-39</b>
2-3-1	Required Objects .....	2-39
2-3-2	Objects Required for Specific Instructions .....	2-40

## Section 3 Axis Command Instructions

<b>MC_Power</b> .....	<b>3-3</b>
Variables .....	3-3
Function .....	3-4
<b>MC_MoveJog</b> .....	<b>3-8</b>
Variables .....	3-8
Function .....	3-9
<b>MC_Home</b> .....	<b>3-18</b>
Variables .....	3-18
Function .....	3-19
<b>MC_HomeWithParameter</b> .....	<b>3-41</b>
Variables .....	3-41
Function .....	3-44
<b>MC_Move</b> .....	<b>3-47</b>
Variables .....	3-47
Function .....	3-49
<b>MC_MoveAbsolute</b> .....	<b>3-52</b>
Variables .....	3-52
Function .....	3-54
Sample Programming 1 .....	3-60
Sample Programming 2 .....	3-69
<b>MC_MoveRelative</b> .....	<b>3-79</b>
Variables .....	3-79
Function .....	3-81
<b>MC_MoveVelocity</b> .....	<b>3-87</b>
Variables .....	3-87
Function .....	3-89
Sample Programming .....	3-93
<b>MC_MoveZeroPosition</b> .....	<b>3-103</b>
Variables .....	3-103
Function .....	3-105
<b>MC_MoveFeed</b> .....	<b>3-110</b>
Variables .....	3-110
Function .....	3-114
Sample Programming .....	3-126
<b>MC_Stop</b> .....	<b>3-139</b>
Variables .....	3-139
Function .....	3-140
<b>MC_ImmediateStop</b> .....	<b>3-148</b>
Variables .....	3-148
Function .....	3-149

<b>MC_SetPosition</b> .....	<b>3-153</b>
Variables .....	3-153
Function .....	3-154
<b>MC_SetOverride</b> .....	<b>3-160</b>
Variables .....	3-160
Function .....	3-161
<b>MC_ResetFollowingError</b> .....	<b>3-166</b>
Variables .....	3-166
Function .....	3-167
<b>MC_CamIn</b> .....	<b>3-173</b>
Variables .....	3-173
Function .....	3-177
Sample Programming 1 .....	3-201
Sample Programming 2 .....	3-212
<b>MC_CamOut</b> .....	<b>3-232</b>
Variables .....	3-232
Function .....	3-233
<b>MC_CamMonitor</b> .....	<b>3-237</b>
Variables .....	3-237
Function .....	3-240
Precautions for Correct Use .....	3-245
<b>MC_GearIn</b> .....	<b>3-246</b>
Variables .....	3-246
Function .....	3-248
Sample Programming .....	3-255
<b>MC_GearInPos</b> .....	<b>3-267</b>
Variables .....	3-267
Function .....	3-270
Sample Programming .....	3-278
<b>MC_GearOut</b> .....	<b>3-290</b>
Variables .....	3-290
Function .....	3-291
<b>MC_MoveLink</b> .....	<b>3-295</b>
Variables .....	3-295
Function .....	3-298
Sample Programming .....	3-308
<b>MC_CombineAxes</b> .....	<b>3-319</b>
Variables .....	3-319
Function .....	3-322
<b>MC_Phasing</b> .....	<b>3-331</b>
Variables .....	3-331
Function .....	3-333
<b>MC_TorqueControl</b> .....	<b>3-338</b>
Variables .....	3-338
Function .....	3-340
<b>MC_SetTorqueLimit</b> .....	<b>3-351</b>
Variables .....	3-351
Function .....	3-353
<b>MC_ZoneSwitch</b> .....	<b>3-358</b>
Variables .....	3-358
Function .....	3-359
<b>MC_TouchProbe</b> .....	<b>3-364</b>
Variables .....	3-364
Function .....	3-367
Sample Programming .....	3-379
<b>MC_AbortTrigger</b> .....	<b>3-386</b>

Variables .....	3-386
Function .....	3-387
<b>MC_AxesObserve.....</b>	<b>3-390</b>
Variables .....	3-390
Function .....	3-392
<b>MC_SyncMoveVelocity .....</b>	<b>3-397</b>
Variables .....	3-397
Function .....	3-399
<b>MC_SyncMoveAbsolute .....</b>	<b>3-407</b>
Variables .....	3-407
Function .....	3-409
<b>MC_Reset.....</b>	<b>3-414</b>
Variables .....	3-414
Function .....	3-415
<b>MC_ChangeAxisUse .....</b>	<b>3-418</b>
Variables .....	3-418
Function .....	3-419
<b>MC_DigitalCamSwitch .....</b>	<b>3-424</b>
Variables .....	3-425
Function .....	3-426
Sample Programming .....	3-435
<b>MC_TimeStampToPos .....</b>	<b>3-444</b>
Variables .....	3-444
Function .....	3-445
Sample Programming .....	3-448
<b>MC_PeriodicSyncVariables .....</b>	<b>3-456</b>
Variables .....	3-456
Function .....	3-457
Sample Programming .....	3-460
<b>MC_SyncOffsetPosition .....</b>	<b>3-464</b>
Variables .....	3-464
Function .....	3-466
<b>MC_OffsetPosition .....</b>	<b>3-474</b>
Variables .....	3-474
Function .....	3-476

## Section 4 Axes Group Instructions

<b>MC_GroupEnable .....</b>	<b>4-2</b>
Variables .....	4-2
Function .....	4-3
<b>MC_GroupDisable .....</b>	<b>4-6</b>
Variables .....	4-6
Function .....	4-7
<b>MC_MoveLinear.....</b>	<b>4-11</b>
Variables .....	4-11
Function .....	4-13
Sample Programming .....	4-24
<b>MC_MoveLinearAbsolute .....</b>	<b>4-40</b>
Variables .....	4-40
Function .....	4-42
<b>MC_MoveLinearRelative.....</b>	<b>4-43</b>
Variables .....	4-43
Function .....	4-45
<b>MC_MoveCircular2D .....</b>	<b>4-46</b>

Variables .....	4-46
Function .....	4-49
Sample Programming .....	4-61
<b>MC_GroupStop .....</b>	<b>4-74</b>
Variables .....	4-74
Function .....	4-76
<b>MC_GroupImmediateStop .....</b>	<b>4-82</b>
Variables .....	4-82
Function .....	4-83
<b>MC_GroupSetOverride .....</b>	<b>4-86</b>
Variables .....	4-86
Function .....	4-87
<b>MC_GroupReadPosition .....</b>	<b>4-91</b>
Variables .....	4-91
Function .....	4-92
<b>MC_ChangeAxesInGroup .....</b>	<b>4-95</b>
Variables .....	4-95
Function .....	4-96
<b>MC_GroupSyncMoveAbsolute .....</b>	<b>4-99</b>
Variables .....	4-99
Function .....	4-101
<b>MC_GroupReset .....</b>	<b>4-106</b>
Variables .....	4-106
Function .....	4-107

## Section 5 Common Command Instructions

<b>MC_SetCamTableProperty .....</b>	<b>5-2</b>
Variables .....	5-2
Function .....	5-3
<b>MC_SaveCamTable .....</b>	<b>5-8</b>
Variables .....	5-8
Function .....	5-9
<b>MC_Write .....</b>	<b>5-13</b>
Variables .....	5-13
Function .....	5-16
<b>MC_GenerateCamTable .....</b>	<b>5-19</b>
Variables .....	5-19
Function .....	5-21
Sample Programming .....	5-35
<b>MC_WriteAxisParameter .....</b>	<b>5-49</b>
Variables .....	5-49
Function .....	5-50
<b>MC_ReadAxisParameter .....</b>	<b>5-64</b>
Variables .....	5-64
Function .....	5-66

## Appendices

<b>A-1 Instructions for Which Multi-execution Is Supported .....</b>	<b>A-2</b>
A-1-1 Axis and Axes Group Status .....	A-2
A-1-2 State Transitions and Instructions for which Multi-execution Is Supported .....	A-4
<b>A-2 Version Information .....</b>	<b>A-11</b>



## Index

---

# Terms and Conditions Agreement

## Warranty, Limitations of Liability

### Warranties

#### ● Exclusive Warranty

Omron's exclusive warranty is that the Products will be free from defects in materials and workmanship for a period of twelve months from the date of sale by Omron (or such other period expressed in writing by Omron). Omron disclaims all other warranties, express or implied.

#### ● Limitations

OMRON MAKES NO WARRANTY OR REPRESENTATION, EXPRESS OR IMPLIED, ABOUT NON-INFRINGEMENT, MERCHANTABILITY OR FITNESS FOR A PARTICULAR PURPOSE OF THE PRODUCTS. BUYER ACKNOWLEDGES THAT IT ALONE HAS DETERMINED THAT THE PRODUCTS WILL SUITABLY MEET THE REQUIREMENTS OF THEIR INTENDED USE.

Omron further disclaims all warranties and responsibility of any type for claims or expenses based on infringement by the Products or otherwise of any intellectual property right.

#### ● Buyer Remedy

Omron's sole obligation hereunder shall be, at Omron's election, to (i) replace (in the form originally shipped with Buyer responsible for labor charges for removal or replacement thereof) the non-complying Product, (ii) repair the non-complying Product, or (iii) repay or credit Buyer an amount equal to the purchase price of the non-complying Product; provided that in no event shall Omron be responsible for warranty, repair, indemnity or any other claims or expenses regarding the Products unless Omron's analysis confirms that the Products were properly handled, stored, installed and maintained and not subject to contamination, abuse, misuse or inappropriate modification. Return of any Products by Buyer must be approved in writing by Omron before shipment. Omron Companies shall not be liable for the suitability or unsuitability or the results from the use of Products in combination with any electrical or electronic components, circuits, system assemblies or any other materials or substances or environments. Any advice, recommendations or information given orally or in writing, are not to be construed as an amendment or addition to the above warranty.

See <https://www.omron.com/global/> or contact your Omron representative for published information.

### Limitation on Liability; Etc

OMRON COMPANIES SHALL NOT BE LIABLE FOR SPECIAL, INDIRECT, INCIDENTAL, OR CONSEQUENTIAL DAMAGES, LOSS OF PROFITS OR PRODUCTION OR COMMERCIAL LOSS IN ANY

WAY CONNECTED WITH THE PRODUCTS, WHETHER SUCH CLAIM IS BASED IN CONTRACT, WARRANTY, NEGLIGENCE OR STRICT LIABILITY.

Further, in no event shall liability of Omron Companies exceed the individual price of the Product on which liability is asserted.

## Application Considerations

### Suitability of Use

Omron Companies shall not be responsible for conformity with any standards, codes or regulations which apply to the combination of the Product in the Buyer's application or use of the Product. At Buyer's request, Omron will provide applicable third party certification documents identifying ratings and limitations of use which apply to the Product. This information by itself is not sufficient for a complete determination of the suitability of the Product in combination with the end product, machine, system, or other application or use. Buyer shall be solely responsible for determining appropriateness of the particular Product with respect to Buyer's application, product or system. Buyer shall take application responsibility in all cases.

NEVER USE THE PRODUCT FOR AN APPLICATION INVOLVING SERIOUS RISK TO LIFE OR PROPERTY OR IN LARGE QUANTITIES WITHOUT ENSURING THAT THE SYSTEM AS A WHOLE HAS BEEN DESIGNED TO ADDRESS THE RISKS, AND THAT THE OMRON PRODUCT(S) IS PROPERLY RATED AND INSTALLED FOR THE INTENDED USE WITHIN THE OVERALL EQUIPMENT OR SYSTEM.

### Programmable Products

Omron Companies shall not be responsible for the user's programming of a programmable Product, or any consequence thereof.

## Disclaimers

### Performance Data

Data presented in Omron Company websites, catalogs and other materials is provided as a guide for the user in determining suitability and does not constitute a warranty. It may represent the result of Omron's test conditions, and the user must correlate it to actual application requirements. Actual performance is subject to the Omron's Warranty and Limitations of Liability.

### Change in Specifications

Product specifications and accessories may be changed at any time based on improvements and other reasons. It is our practice to change part numbers when published ratings or features are changed, or when significant construction changes are made. However, some specifications of the Product may

be changed without any notice. When in doubt, special part numbers may be assigned to fix or establish key specifications for your application. Please consult with your Omron's representative at any time to confirm actual specifications of purchased Product.

### **Errors and Omissions**

Information presented by Omron Companies has been checked and is believed to be accurate; however, no responsibility is assumed for clerical, typographical or proofreading errors or omissions.

### **Statement of security responsibilities for assumed use cases and against threats**

OMRON SHALL NOT BE RESPONSIBLE AND/OR LIABLE FOR ANY LOSS, DAMAGE, OR EXPENSES DIRECTLY OR INDIRECTLY RESULTING FROM THE INFECTION OF OMRON PRODUCTS, ANY SOFTWARE INSTALLED THEREON OR ANY COMPUTER EQUIPMENT, COMPUTER PROGRAMS, NETWORKS, DATABASES OR OTHER PROPRIETARY MATERIAL CONNECTED THERETO BY DISTRIBUTED DENIAL OF SERVICE ATTACK, COMPUTER VIRUSES, OTHER TECHNOLOGICALLY HARMFUL MATERIAL AND/OR UNAUTHORIZED ACCESS.

It shall be the users sole responsibility to determine and use adequate measures and checkpoints to satisfy the users particular requirements for (i) antivirus protection, (ii) data input and output, (iii) maintaining a means for reconstruction of lost data, (iv) preventing Omron Products and/or software installed thereon from being infected with computer viruses and (v) protecting Omron Products from unauthorized access.

# Safety Precautions

---

Refer to the following manuals for safety precautions.

- *NX-series CPU Unit Hardware User's Manual (Cat. No. W535)*
- *NX-series NX502 CPU Unit Hardware User's Manual (Cat. No. W629)*
- *NX-series NX102 CPU Unit Hardware User's Manual (Cat. No. W593)*
- *NX-series NX1P2 CPU Unit Hardware User's Manual (Cat. No. W578)*
- *NJ-series CPU Unit Hardware User's Manual (Cat No. W500)*

# Precautions for Safe Use

---

Refer to the following manuals for precautions for safe use.

- *NX-series CPU Unit Hardware User's Manual (Cat. No. W535)*
- *NX-series NX502 CPU Unit Hardware User's Manual (Cat. No. W629)*
- *NX-series NX102 CPU Unit Hardware User's Manual (Cat. No. W593)*
- *NX-series NX1P2 CPU Unit Hardware User's Manual (Cat. No. W578)*
- *NJ-series CPU Unit Hardware User's Manual (Cat No. W500)*

# Precautions for Correct Use

---

Refer to the following manuals for precautions for correct use.

- *NX-series CPU Unit Hardware User's Manual (Cat. No. W535)*
- *NX-series NX502 CPU Unit Hardware User's Manual (Cat. No. W629)*
- *NX-series NX102 CPU Unit Hardware User's Manual (Cat. No. W593)*
- *NX-series NX1P2 CPU Unit Hardware User's Manual (Cat. No. W578)*
- *NJ-series CPU Unit Hardware User's Manual (Cat No. W500)*

# Regulations and Standards

---

Refer to the following manuals for regulations and standards.

- *NX-series CPU Unit Hardware User's Manual (Cat. No. W535)*
- *NX-series NX502 CPU Unit Hardware User's Manual (Cat. No. W629)*
- *NX-series NX102 CPU Unit Hardware User's Manual (Cat. No. W593)*
- *NX-series NX1P2 CPU Unit Hardware User's Manual (Cat. No. W578)*
- *NJ-series CPU Unit Hardware User's Manual (Cat No. W500)*



# Versions

---

Hardware revisions and unit versions are used to manage the hardware and software in NJ/NX-series Units and EtherCAT slaves. The hardware revision or unit version is updated each time there is a change in hardware or software specifications. Even when two Units or EtherCAT slaves have the same model number, they will have functional or performance differences if they have different hardware revisions or unit versions.

Refer to the following manuals for versions.

- *NX-series CPU Unit Hardware User's Manual (Cat. No. W535)*
- *NX-series NX502 CPU Unit Hardware User's Manual (Cat. No. W629)*
- *NX-series NX102 CPU Unit Hardware User's Manual (Cat. No. W593)*
- *NX-series NX1P2 CPU Unit Hardware User's Manual (Cat. No. W578)*
- *NJ-series CPU Unit Hardware User's Manual (Cat No. W500)*

## Unit Versions of CPU Units and Sysmac Studio Versions

The functions that are supported depend on the unit version of the NJ/NX-series CPU Unit. The version of Sysmac Studio that supports the functions that were added for an upgrade is also required to use those functions.

Refer to the *NJ/NX-series CPU Unit Software User's Manual (Cat. No. W501)* for the relationship between the unit versions of the CPU Unit and the Sysmac Studio versions, and for the functions that are supported by each unit version.

# Related Manuals

The following are the manuals related to this manual. Use these manuals for reference.

Manual name	Cat. No.	Model numbers	Application	Description
NX-series CPU Unit Hardware User's Manual	W535	NX701-□□□□	Learning the basic specifications of the NX701 CPU Units, including introductory information, designing, installation, and maintenance. Mainly hardware information is provided.	An introduction to the entire NX701 system is provided along with the following information on the CPU Unit. <ul style="list-style-type: none"> <li>• Features and system configuration</li> <li>• Introduction</li> <li>• Part names and functions</li> <li>• General specifications</li> <li>• Installation and wiring</li> <li>• Maintenance and inspection</li> </ul>
NX-series NX502 CPU Unit Hardware User's Manual	W629	NX502-□□□□	Learning the basic specifications of the NX502 CPU Units, including introductory information, designing, installation, and maintenance. Mainly hardware information is provided.	An introduction to the entire NX502 system is provided along with the following information on the CPU Unit. <ul style="list-style-type: none"> <li>• Features and system configuration</li> <li>• Introduction</li> <li>• Part names and functions</li> <li>• General specifications</li> <li>• Installation and wiring</li> <li>• Maintenance and inspection</li> </ul>
NX-series NX102 CPU Unit Hardware User's Manual	W593	NX102-□□□□	Learning the basic specifications of the NX102 CPU Units, including introductory information, designing, installation, and maintenance. Mainly hardware information is provided.	An introduction to the entire NX102 system is provided along with the following information on the CPU Unit. <ul style="list-style-type: none"> <li>• Features and system configuration</li> <li>• Introduction</li> <li>• Part names and functions</li> <li>• General specifications</li> <li>• Installation and wiring</li> <li>• Maintenance and inspection</li> </ul>
NX-series NX1P2 CPU Unit Hardware User's Manual	W578	NX1P2-□□□□	Learning the basic specifications of the NX1P2 CPU Units, including introductory information, designing, installation, and maintenance. Mainly hardware information is provided.	An introduction to the entire NX1P2 system is provided along with the following information on the CPU Unit. <ul style="list-style-type: none"> <li>• Features and system configuration</li> <li>• Introduction</li> <li>• Part names and functions</li> <li>• General specifications</li> <li>• Installation and wiring</li> <li>• Maintenance and inspection</li> </ul>
NJ-series CPU Unit Hardware User's Manual	W500	NJ501-□□□□ NJ301-□□□□ NJ101-□□□□	Learning the basic specifications of the NJ-series CPU Units, including introductory information, designing, installation, and maintenance. Mainly hardware information is provided.	An introduction to the entire NJ-series system is provided along with the following information on the CPU Unit. <ul style="list-style-type: none"> <li>• Features and system configuration</li> <li>• Introduction</li> <li>• Part names and functions</li> <li>• General specifications</li> <li>• Installation and wiring</li> <li>• Maintenance and inspection</li> </ul>
NJ/NX-series CPU Unit Software User's Manual	W501	NX701-□□□□ NX502-□□□□ NX102-□□□□ NX1P2-□□□□ NJ501-□□□□ NJ301-□□□□ NJ101-□□□□	Learning how to program and set up an NJ/NX-series CPU Unit. Mainly software information is provided.	The following information is provided on a Controller built with an NJ/NX-series CPU Unit. <ul style="list-style-type: none"> <li>• CPU Unit operation</li> <li>• CPU Unit features</li> <li>• Initial settings</li> <li>• Programming based on IEC 61131-3 language specifications</li> </ul>

Manual name	Cat. No.	Model numbers	Application	Description
NX-series NX1P2 CPU Unit Built-in I/O and Option Board User's Manual	W579	NX1P2-□□□□	Learning about the details of functions only for an NX-series NX1P2 CPU Unit and an introduction of functions for an NJ/NX-series CPU Unit.	Of the functions for an NX1P2 CPU Unit, the following information is provided. <ul style="list-style-type: none"> <li>Built-in I/O</li> <li>Serial Communications Option Boards</li> <li>Analog I/O Option Boards</li> </ul> An introduction of following functions for an NJ/NX-series CPU Unit is also provided. <ul style="list-style-type: none"> <li>Motion control functions</li> <li>EtherNet/IP communications functions</li> <li>EtherCAT communications functions</li> </ul>
NJ/NX-series Instructions Reference Manual	W502	NX701-□□□□ NX502-□□□□ NX102-□□□□ NX1P2-□□□□ NJ501-□□□□ NJ301-□□□□ NJ101-□□□□	Learning detailed specifications on the basic instructions of an NJ/NX-series CPU Unit.	The instructions in the instruction set (IEC 61131-3 specifications) are described.
NJ/NX-series CPU Unit Motion Control User's Manual	W507	NX701-□□□□ NX502-□□□□ NX102-□□□□ NX1P2-□□□□ NJ501-□□□□ NJ301-□□□□ NJ101-□□□□	Learning about motion control settings and programming concepts.	The settings and operation of the CPU Unit and programming concepts for motion control are described.
NJ/NX-series Motion Control Instructions Reference Manual	W508	NX701-□□□□ NX502-□□□□ NX102-□□□□ NX1P2-□□□□ NJ501-□□□□ NJ301-□□□□ NJ101-□□□□	Learning about the specifications of the motion control instructions.	The motion control instructions are described.
NJ/NX-series CPU Unit Built-in EtherCAT® Port User's Manual	W505	NX701-□□□□ NX502-□□□□ NX102-□□□□ NX1P2-□□□□ NJ501-□□□□ NJ301-□□□□ NJ101-□□□□	Using the built-in EtherCAT port on an NJ/NX-series CPU Unit.	Information on the built-in EtherCAT port is provided. This manual provides an introduction and provides information on the configuration, features, and setup.
NJ/NX-series CPU Unit Built-in EtherNet/IP™ Port User's Manual	W506	NX701-□□□□ NX502-□□□□ NX102-□□□□ NX1P2-□□□□ NJ501-□□□□ NJ301-□□□□ NJ101-□□□□	Using the built-in EtherNet/IP port on an NJ/NX-series CPU Unit.	Information on the built-in EtherNet/IP port is provided. Information is provided on the basic setup, tag data links, and other features.
NJ/NX-series CPU Unit OPC UA User's Manual	W588	NX701-□□□□ NX502-□□□□ NX102-□□□□ NJ501-1□00	Using the OPC UA.	Describes the OPC UA.
NX-series CPU Unit FINS Function User's Manual	W596	NX701-□□20 NX502-□□□□ NX102-□□□□	Using the FINS function of an NX-series CPU Unit.	Describes the FINS function of an NX-series CPU Unit.
NJ/NX-series Database Connection CPU Units User's Manual	W527	NX701-□□20 NX502-□□□□ NX102-□□20 NJ501-□□20 NJ101-□□20	Using the database connection service with NJ/NX-series Controllers.	Describes the database connection service.
NJ-series SECS/GEM CPU Units User's Manual	W528	NJ501-1340	Using the GEM Services with NJ-series Controllers.	Provides information on the GEM Services.

Manual name	Cat. No.	Model numbers	Application	Description
NJ-series Robot Integrated CPU Unit User's Manual	O037	NJ501-R□□□	Using the NJ-series Robot Integrated CPU Unit.	Describes the settings and operation of the CPU Unit and programming concepts for OMRON ro- bot control.
Sysmac Studio Robot Integrated System Build- ing Function with Robot Inte- grated CPU Unit Operation Manual	W595	SYSMAC-SE2□□ □ SYSMAC- SE200D-64	Learning about the operating procedures and functions of the Sysmac Studio to configure Robot Inte- grated System using Robot Integrated CPU Unit.	Describes the operating procedures of the Sys- mac Studio for Robot Integrated CPU Unit.
Sysmac Studio Robot Integrated System Build- ing Function with IPC Applica- tion Controller Operation Man- ual	W621	SYSMAC-SE2□□ □ SYSMAC- SE200D-64	Learning about the operating procedures and functions of the Sysmac Studio to configure Robot Inte- grated System using IPC Application Con- troller.	Describes the operating procedures of the Sys- mac Studio for IPC Application Controller.
Sysmac Studio 3D Simulation Function Opera- tion Manual	W618	SYSMAC-SE2□□ □ SYSMAC-SA4□□ □-64	Learning about an outline of the 3D sim- ulation function of the Sysmac Studio and how to use the func- tion.	Describes an outline, execution procedures, and operating procedures for the 3D simulation func- tion of the Sysmac Studio.
NJ-series NJ Robotics CPU Unit User's Manual	W539	NJ501-4□□□ NJ501-R□□□	Controlling robots with NJ-series CPU Units.	Describes the functionality to control robots.
NJ/NY-series NC Integrated Controller User's Manual	O030	NJ501-5300 NY532-5400	Performing numerical control with NJ/NY- series Controllers.	Describes the functionality to perform the numeri- cal control.
NJ/NY-series G code Instructions Reference Manual	O031	NJ501-5300 NY532-5400	Learning about the specifications of the G code/M code in- structions.	The G code/M code instructions are described.
NJ/NX-series Troubleshooting Manual	W503	NX701-□□□□ NX502-□□□□ NX102-□□□□ NX1P2-□□□□ NJ501-□□□□ NJ301-□□□□ NJ101-□□□□	Learning about the errors that may be detected in an NJ/NX-series Con- troller.	Concepts on managing errors that may be detect- ed in an NJ/NX-series Controller and information on individual errors are described.
Sysmac Studio Version 1 Operation Manual	W504	SYSMAC -SE2□□□	Learning about the operating procedures and functions of the Sysmac Studio.	Describes the operating procedures of the Sys- mac Studio.
CNC Operator Operation Manual	O032	SYSMAC-RTNC□ □□D	Learning an introduc- tion of the CNC Op- erator and how to use it.	An introduction of the CNC Operator, installation procedures, basic operations, connection opera- tions, and operating procedures for main func- tions are described.
NX-series EtherCAT® Coupler Unit User's Manual	W519	NX-ECC□□□	Learning how to use the NX-series Ether- CAT Coupler Unit and EtherCAT Slave Terminals.	The following items are described: the overall system and configuration methods of an Ether- CAT Slave Terminal (which consists of an NX-ser- ies EtherCAT Coupler Unit and NX Units), and in- formation on hardware, setup, and functions to set up, control, and monitor NX Units through EtherCAT.

Manual name	Cat. No.	Model numbers	Application	Description
NX-series Data Reference Manual	W525	NX-□□□□□□	Referencing lists of the data that is required to configure systems with NX-series Units.	Lists of the power consumptions, weights, and other NX Unit data that is required to configure systems with NX-series Units are provided.
NX-series NX Units User's Manual	W521	NX-ID□□□□ NX-IA□□□□ NX-OC□□□□ NX-OD□□□□ NX-MD□□□□	Learning how to use NX Units.	Describes the hardware, setup methods, and functions of the NX Units. Manuals are available for the following Units. Digital I/O Units, Analog I/O Units, System Units, Position Interface Units, Communications Interface Units, Load Cell Input Unit, and IO-Link Master Units.
	W522	NX-AD□□□□ NX-DA□□□□		
	W592	NX-HAD□□□		
	W566	NX-TS□□□□ NX-HB□□□□		
	W523	NX-PD1□□□ NX-PF0□□□ NX-PC0□□□ NX-TBX01		
	W524	NX-EC0□□□ NX-ECS□□□ NX-PG0□□□		
	W540	NX-CIF□□□		
	W565	NX-RS□□□□		
	W567	NX-ILM□□□		
GX-series EtherCAT Slave Units User's Manual	W488	GX-ID□□□□ GX-OD□□□□ GX-OC□□□□ GX-MD□□□□ GX-AD□□□□ GX-DA□□□□ GX-EC□□□□ XWT-ID□□ XWT-OD□□	Learning how to use the EtherCAT remote I/O terminals.	Describes the hardware, setup methods and functions of the EtherCAT remote I/O terminals.
AC Servomotors/Servo Drives 1S-series with Built-in EtherCAT® Communications User's Manual	I586	R88M-1□ R88D-1SN□-ECT	Learning how to use the Servomotors/Servo Drives with built-in EtherCAT Communications.	Describes the hardware, setup methods and functions of the Servomotors/Servo Drives with built-in EtherCAT Communications.
	I621	R88M-1AL□/ -1AM□ R88D-1SAN□-ECT		
AC Servomotors/Servo Drives G5 Series with Built-in EtherCAT® Communications User's Manual	I576	R88M-K□ R88D-KN□-ECT	Learning how to use the AC Servomotors/Servo Drives with built-in EtherCAT Communications.	Describes the hardware, setup methods and functions of the AC Servomotors/Servo Drives with built-in EtherCAT Communications. The Linear Motor Type models and dedicated models for position control are available in G5-series.
	I577	R88L-EC-□ R88D-KN□-ECT-L		

# Revision History

A manual revision code appears as a suffix to the catalog number on the front and back covers of the manual.

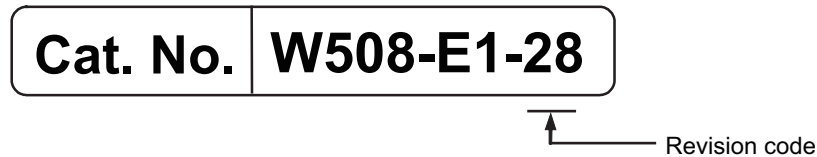

Revision code	Date	Revised content
01	July 2011	Original production
02	January 2012	<ul style="list-style-type: none"> <li>• Added the following axes group instructions               <ul style="list-style-type: none"> <li>• MC_GroupReadPosition (Read Axes Group Position)</li> <li>• MC_ChangeAxesInGroup (Change Axes in Group)</li> <li>• MC_GroupSyncMoveAbsolute (Axes Group Cyclic Synchronous Absolute Positioning)</li> </ul> </li> <li>• Corrected mistakes.</li> </ul>
03	May 2012	<ul style="list-style-type: none"> <li>• Made changes accompanying the upgrade to unit version 1.02 of the CPU Unit.</li> <li>• Corrected mistakes.</li> </ul>
04	August 2012	Made changes accompanying the upgrade to unit version 1.03 of the CPU Unit.
05	February 2013	Made changes accompanying the upgrade to unit version 1.04 of the CPU Unit.
06	April 2013	<ul style="list-style-type: none"> <li>• Made changes accompanying the upgrade to unit version 1.05 of the CPU Unit.</li> <li>• Corrected mistakes.</li> </ul>
07	June 2013	<ul style="list-style-type: none"> <li>• Made changes accompanying the upgrade to unit version 1.06 of the CPU Unit.</li> <li>• Corrected mistakes.</li> </ul>
08	December 2013	<ul style="list-style-type: none"> <li>• Made changes accompanying the upgrade to unit version 1.08 of the CPU Unit.</li> <li>• Corrected mistakes.</li> </ul>
09	July 2014	<ul style="list-style-type: none"> <li>• Made changes accompanying the upgrade to unit version 1.09 of the CPU Unit.</li> <li>• Corrected mistakes.</li> </ul>
10	January 2015	<ul style="list-style-type: none"> <li>• Made changes accompanying the upgrade to unit version 1.10 of the CPU Unit.</li> <li>• Corrected mistakes.</li> </ul>
11	April 2015	<ul style="list-style-type: none"> <li>• Made changes accompanying the addition of NX-series NX701-□□□□ CPU Units and NJ-series NJ101-□□□□ CPU Units.</li> <li>• Corrected mistakes.</li> </ul>
12	April 2016	<ul style="list-style-type: none"> <li>• Made changes accompanying the upgrade to unit version 1.11 of the CPU Unit.</li> <li>• Corrected mistakes.</li> </ul>
13	July 2016	<ul style="list-style-type: none"> <li>• Made changes accompanying the upgrade to unit version 1.12 of the CPU Unit.</li> <li>• Corrected mistakes.</li> </ul>

Revision code	Date	Revised content
14	October 2016	<ul style="list-style-type: none"> <li>• Made changes accompanying the addition of NX-series NX1P2 CPU Units.</li> <li>• Made changes accompanying the upgrade to unit version 1.13 of the CPU Unit.</li> <li>• Corrected mistakes.</li> </ul>
15	April 2017	Corrected mistakes.
16	October 2017	Corrected mistakes.
17	April 2018	<ul style="list-style-type: none"> <li>• Made changes accompanying the addition of NX-series NX102 CPU Units.</li> <li>• Made changes accompanying the transfer of event codes to the <i>NJ/NX-series Troubleshooting Manual (Cat. No. W503)</i>.</li> <li>• Corrected mistakes.</li> </ul>
18	July 2018	Corrected mistakes.
19	January 2019	Corrected mistakes.
20	April 2019	<ul style="list-style-type: none"> <li>• Made changes accompanying the addition of 1S-series AC Servomotors/ Servo Drives.</li> <li>• Made changes accompanying the addition of the MC_CamMonitor (Cam Monitor) instruction and MC_OffsetPosition (Position Offset Compensation) instruction.</li> </ul>
21	July 2019	Made changes accompanying the release of version 1.29 of the Sysmac Studio.
22	October 2019	<ul style="list-style-type: none"> <li>• Made changes accompanying addition of NX1P2-9B□□□□.</li> <li>• Corrected mistakes.</li> </ul>
23	August 2020	Made changes accompanying the addition of NJ501-R□□□.
24	April 2022	Corrected mistakes.
25	April 2022	Added information to Terms and Conditions Agreement.
26	April 2023	Made changes accompanying addition of NX502-1□□□.
27	April 2024	Made changes accompanying the addition of NX502-1700 and NX502-1600.
28	October 2024	Corrected mistakes.





# 1

# Introduction to Motion Control Instructions

This section gives an introduction to motion control instructions supported by NJ/NX-series CPU Units.

---

<b>1-1</b>	<b>Motion Control Instructions .....</b>	<b>1-2</b>
1-1-1	Function Blocks for PLCopen® Motion Control .....	1-2
1-1-2	Overview of Motion Control Instructions.....	1-2
1-1-3	Precautions for Master and Auxiliary Axes in Synchronized Control .....	1-6
<b>1-2</b>	<b>Basic Information on Motion Control Instructions .....</b>	<b>1-9</b>
1-2-1	Motion Control Instruction Names .....	1-9
1-2-2	Languages for Motion Control Instructions.....	1-9
1-2-3	Motion Control Instruction Locations .....	1-10
1-2-4	Multi-execution of Motion Control Instructions .....	1-17
1-2-5	Online Editing of Motion Control Instructions .....	1-18
1-2-6	Changes in the Operating Mode of the CPU Unit .....	1-19

# 1-1 Motion Control Instructions

Motion control instructions are used in the user program to execute motion controls for an NJ/NX-series CPU Unit. These instructions are defined as function blocks.

The motion control instructions of the MC Function Module are based on the technical specifications of function blocks for PLCopen<sup>®</sup> motion control.

There are two types of motion control instructions: PLCopen<sup>®</sup>-defined instructions and instructions that are unique to the MC Function Module.

This section provides an overview of the PLCopen<sup>®</sup> motion control function blocks and motion control instructions.

For details on motion control instructions, refer to the *NJ/NX-series CPU Unit Motion Control User's Manual (Cat. No. W507)*.

Refer to the *NX-series Position Interface Units User's Manual (Cat. No. W524)* for information on using the NX-series Position Interface Units.



## Version Information

A CPU Unit with unit version 1.05 or later and Sysmac Studio version 1.06 or higher are required to use NX-series Position Interface Units.

## 1-1-1 Function Blocks for PLCopen<sup>®</sup> Motion Control

PLCopen<sup>®</sup> standardizes motion control function blocks to define a program interface for the languages specified in IEC 61131-3 (JIS B 3503).

Single-axis positioning, electronic cams, and multi-axes coordinated control are defined along with basic procedures for executing instructions.

By using PLCopen<sup>®</sup> motion control function blocks, programming can be more easily reused without hardware dependence.

Costs for training and support are also reduced.



## Additional Information

### PLCopen<sup>®</sup>

PLCopen<sup>®</sup> is a promotion body for IEC 61131-3 that has its headquarters in Europe and a worldwide membership structure.

IEC 61131-3 is an international standard for PLC programming.

PLCopen<sup>®</sup> Japan is the promotion committee for the Japanese market and consists of members that have concerns related to the Japanese market.

- The website of PLCopen<sup>®</sup> Japan is <http://www.plcopen-japan.jp/>.
- The website of PLCopen<sup>®</sup> Europe (headquarters) is <http://www.plcopen.org/>.

## 1-1-2 Overview of Motion Control Instructions

This section describes items defined in the technical specifications of function blocks for PLCopen<sup>®</sup> motion control and provides an overview of their application in the MC Function Module.

## Types of Motion Control Instructions

The following table list the different types of motion control instructions.

Classification	Type	Functional group	Description
Instructions for common commands	Common administration instructions	Cam tables	These instructions are used to control the common status of the MC Function Module, and to manipulate and monitor data.
		Parameters	
Instructions for axis commands	Single-axis motion instructions	Single-axis position control	These instructions move single axes.
		Single-axis velocity control	
		Single-axis torque control	
		Single-axis synchronized control	
		Single-axis manual operation	
	Single-axis administration instructions	Auxiliary functions for single-axis control	This instructions control or monitor axis status.
Instructions for axes group commands	Multi-axes motion instructions	Multi-axes coordinated control	These instructions perform coordinated movement of an axes group.
	Multi-axes administration instructions	Auxiliary functions for multi-axes coordinated control	These instructions control or monitor axes group status.

## State Transitions

State transitions are defined for axes, axes groups, and instruction execution.

For details on the state and state transitions of the MC Function Module, refer to the *NJ/NX-series CPU Unit Motion Control User's Manual (Cat. No. W507)*.

## Execution and Status of Motion Control Instructions

Variables that start instruction execution or that indicate the execution status are defined as common rules for the instructions.

There are two input variables that start instruction execution: *Execute* and *Enable*.

The output variables that indicate the execution status of an instruction include *Busy*, *Done*, *CommandAborted*, and *Error*.

For detailed specifications of the MC Function Module, refer to the *NJ/NX-series CPU Unit Motion Control User's Manual (Cat. No. W507)*.



### Precautions for Correct Use

The timing in the timing charts that are given in this manual may not necessarily be the same as the timing displayed for data traces on the Sysmac Studio.

Refer to the *NJ/NX-series CPU Unit Software User's Manual (Cat. No. W501)* for details on data tracing.

## Error Processing

You execute motion control instructions to implement motion control with the MC Function Module. When motion control instructions are executed, input parameters and instruction processing are checked for errors.

If an error occurs in an instruction, the *Error* output variable from the instruction changes to TRUE and an error code is output to *ErrorID* output variable.

There are two ways that you can use to program processing of errors for motion control instructions.

### ● Error Processing for Individual Instructions

You can use the *Error* and *ErrorID* output variables from the instruction to process errors that occur for each instruction.

The following example shows how to determine if an Illegal Axis Specification occurs for the instruction with the instance name PWR1.

The instructions are programmed so that error processing is executed if *NoAxisErr* changes to TRUE.

Turning ON the Servo

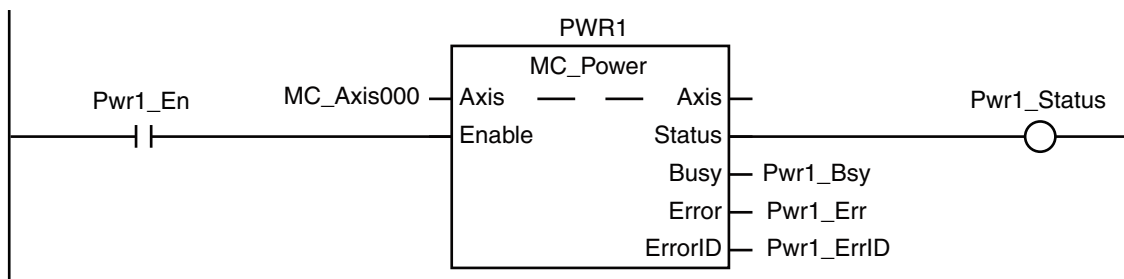

Checking to See If the Specified Axis Exists

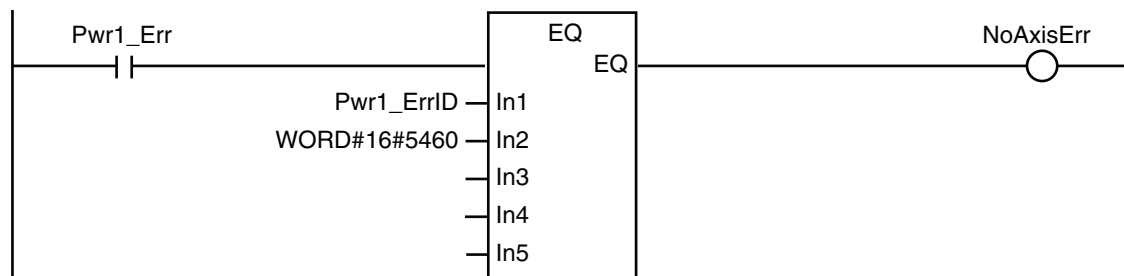

### ● Error Processing for Different Types of Errors

You can use the error status that is provided by the system-defined variables for motion control to process each type of error separately.

The following example shows how to determine if a Slave Communications Error occurs for the axis that is called *MC\_Axis000*. The instructions are programmed so that error processing is executed if *ConnectErr* changes to TRUE.

Checking for Communications Errors between the CPU Unit and Servo Drive

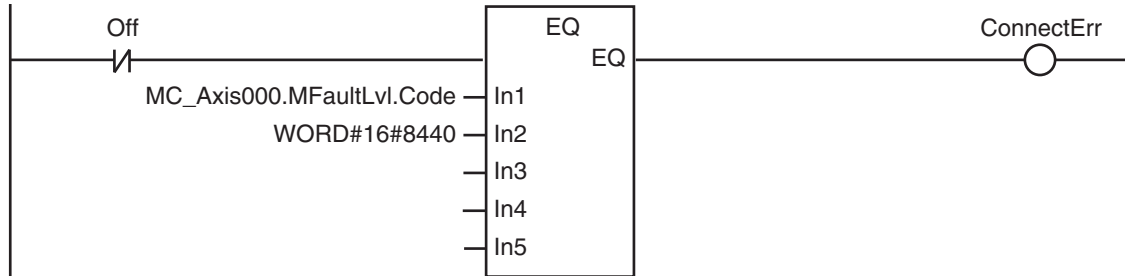

## Changing Input Variables during Execution of Motion Control Instructions (Restarting Instructions)

If the values of the input variables to an instruction instance are changed while the motion control instruction is under execution and then *Execute* is changed to TRUE again, operation will follow the new values.

For details on re-execution of MC Function Module instructions, refer to the *NJ/NX-series CPU Unit Motion Control User's Manual (Cat. No. W507)*.

## Multi-execution of Instructions with *BufferMode*

A different instruction instance can be executed during axis motion.

You can specify when a motion starts by setting an input variable called *BufferMode*.

The following Buffer Modes are supported for *BufferMode*.

- Aborting : Abort (Aborting)
- Buffered : Standby (Buffered)
- Blending Low : Blending with the low velocity (BlendingLow)
- Blending Previous : Blending with the previous velocity (BlendingPrevious)
- Blending Next : Blending with the next velocity (BlendingNext)
- Blending High : Blending with the high velocity (BlendingHigh)

In **Aborting** mode, other motions are aborted and the function block is executed immediately.

In other buffer modes, the next instruction waits until an output variable such as *Done* or *InVelocity* from the currently executed instruction changes to TRUE.

For **Buffered** mode, the next instruction is executed after the current instruction is executed and *Done* changes to TRUE.

For the **Blending** modes, two instruction motions are executed consecutively without pausing. The transition velocity between the two motions is selected from four buffer modes.

For the MC Function Module, *BufferMode* is also referred to as multi-execution of instructions.

For details on multi-execution of instructions for the MC Function Module, refer to the *NJ/NX-series CPU Unit Motion Control User's Manual (Cat. No. W507)*.

Whether multi-execution of instructions is supported in the MC Function Module depends on the current axis status, the current axes group status, and the instruction to execute. Refer to *A-1 Instructions for Which Multi-execution Is Supported* on page A-2 for detailed information.

## Structures Used for Motion Control

Information required for motion control are defined as structures in PLCopen® technical materials. Data type names and basic aspects are defined, but the contents of the structures are not defined.

The main data types defined in PLCopen® and the data types used in the MC Function Module are shown in the following table.

Data type		Definition
PLCopen®	MC Function Module	
AXIS_REF	_sAXIS_REF	This is a structure that contains information on the corresponding axis.
AXES_GROUP_REF	_sGROUP_REF	This is a structure that contains information on the corresponding axes group.
TRIGGER_REF	_sTRIGGER_REF	This is a structure that contains information on trigger inputs. <ul style="list-style-type: none"> <li>• Trigger specifications</li> <li>• Detection pattern information (positive, negative, both, edge, level, pattern recognition, etc.)</li> </ul>
INPUT_REF	---	This is a structure that contains information relating to the input specifications. It may include virtual data. This data type is not used by the MC Function Module.
OUTPUT_REF	_sOUTPUT_REF	This is a structure relating to physical outputs. A CPU Unit with unit version 1.06 or later and Sysmac Studio version 1.07 or higher are required to use the MC Function Module data type.

As shown in the above table, the MC Function Module uses some data types that are defined by PLCopen® and some that are defined specifically for the MC Function Module.

Refer to the *NJ/NX-series CPU Unit Motion Control User's Manual (Cat. No. W507)* for definitions of the data types and structures that are handled by the MC Motion Module.

### 1-1-3 Precautions for Master and Auxiliary Axes in Synchronized Control

Precautions that are related to sudden changes in velocity and conditions that lead to errors are given below for master and auxiliary axes in synchronized control.

#### Sudden Changes in Velocity

When the velocity of the master or auxiliary axis changes suddenly when synchronized motion is started or during synchronized motion, the motion of the slave axis can change suddenly and sometimes place an excessive load on the machine.

Take suitable precautions in the following cases because the velocity of the master or auxiliary axis may change suddenly.

- When one of the following four instructions is executed for the master or auxiliary axis:  
MC\_ImmediateStop instruction  
MC\_SetPosition instruction  
MC\_ResetFollowingError instruction  
MC\_SyncMoveVelocity (Cyclic Synchronous Velocity Control) instruction  
To ensure that the slave axis does not move suddenly, set suitable input parameters and execution timing for the above instructions or execute them after synchronized control has been released.
- When the immediate stop input signal or limit stop input signal changes to TRUE for the master or auxiliary axis
- When the Servo turns OFF for the master or auxiliary axis  
When the Servo is turned OFF when the master or auxiliary axis is a vertical axis, the position of the axis may change suddenly.  
Take suitable measures to prevent the slave axis from moving suddenly, such as applying a brake to the master or auxiliary axis or turning OFF the Servo after synchronized control has been released.
- When you change the control mode of the Servo Drive  
Take suitable precautions for changes in the velocity when an instruction is executed.  
Set suitable input parameters for the instruction.



#### Version Information

With a CPU Unit with unit version 1.10 or later, the operation of the slave axis does not change suddenly even if you use the MC\_SetPosition (Set Position) instruction to change the command current position of the master axis or auxiliary axis for a synchronized control instruction.

## Conditions That Lead to Errors

Some conditions apply to NJ/NX-series CPU Units, and other conditions apply only to NX701 CPU Units.

### ● Conditions for NJ/NX-series CPU Units

When any of the following four conditions occurs for the master or auxiliary axis when synchronized motion is started or during synchronized motion, a Master Axis Position Read Error or Auxiliary Axis Position Read Error occurs for the slave axis.

The *CommandAborted* output variable from the synchronized control instruction changes to TRUE at the same time.

- EtherCAT process data communications are not established.
- An EtherCAT Slave Communications Error occurs while EtherCAT communications are not established.
- An Absolute Encoder Current Position Calculation Failed error occurs.
- The slave is disconnected.

The following occur if multi-execution of instructions is used for synchronized control instructions for the slave axis.

- Even if the master or auxiliary axis is in one of the four conditions given above, multi-execution of instructions is acknowledged normally and the instruction is buffered.
- The motion for the buffered instruction is started as normal if none of the above four conditions exist.



### Additional Information

---

If the MC\_Home or MC\_HomeWithParameter instruction is executed for the master or auxiliary axis or if the MC\_Power instruction is executed for an axis that uses an absolute encoder, the slave ignores the changes in position of the master or auxiliary axis. Therefore, the slave axis does not move suddenly when defining home.

---

### ● Conditions for NX701 CPU Units

If the master axis and auxiliary axis are assigned to a different task from the slave axis, an Illegal Master Axis Specification (error code 5462 hex) occurs for the slave axis and the *Error* output variable from the synchronized control instructions change to TRUE.



## 1-2 Basic Information on Motion Control Instructions

This section describes basic specifications and restrictions for programming with motion control instructions for the MC Function Module built into the NJ/NX-series CPU Unit.

For details on motion control instructions, refer to *Section 3 Axis Command Instructions* on page 3-1, *Section 4 Axes Group Instructions* on page 4-1, and *Section 5 Common Command Instructions* on page 5-1.

### 1-2-1 Motion Control Instruction Names

All motion control instructions for the MC Function Module begin with "MC\_".

To see whether an instruction is defined by PLCopen® or whether it is an instruction defined for the MC Function Module itself, refer to *2-2 Instructions* on page 2-34.

### 1-2-2 Languages for Motion Control Instructions

Motion control instructions of the MC Function Module can be used in the following programming languages.

- Ladder diagrams (LD)
- Structured text (ST)

### Ladder Diagrams (LD)

Instruction instances of motion control instructions are located in ladder diagrams.

The instruction instances can be named.

The following example shows the MC\_MoveAbsolute (Absolute Positioning) instruction.

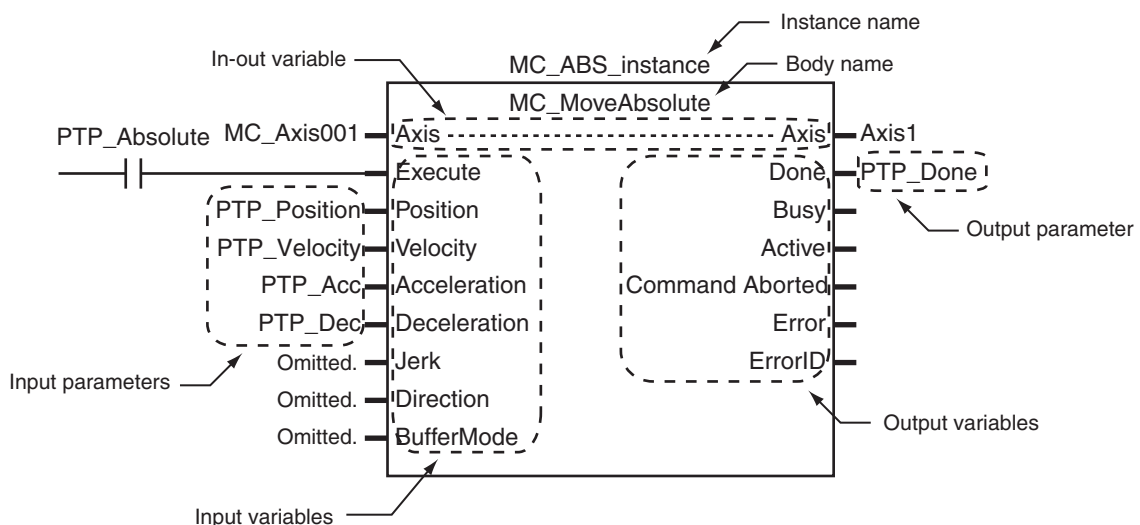

- The axis variable name of the Servo Drive or other device to control is specified with the in-out variable *Axis*.
- Motion conditions, such as the target position or target velocity, are specified with input variables.

- The status of the instruction or the status of the Servo Drive is output with output variables.
- If input parameters are omitted, input variables are set to default values.

## Structured Text (ST)

The instruction instance name is specified.

Instruction variables are written from upper left to lower left, then upper right to lower right.

The following example shows MC\_MoveAbsolute (Absolute Positioning).

```
MC_ABS_instance (
  Axis := MC_Axis001 ,
  Execute := PTP_Absolute ,
  Position := PTP_Position ,
  Velocity := PTP_Velocity ,
  Acceleration := PTP_Acc ,
  Deceleration := PTP_Dec ,
  Jerk := PTP_Jerk ,
  Direction := _mcNoDirection ,
  BufferMode := _mcAborting ,
  Axis => MC_Axis001 ,
  Done => PTP_Done
);
```

### 1-2-3 Motion Control Instruction Locations

This section describes the tasks in which motion control instructions can be located, and the differences in operation that can occur for different locations in the user program.

## Task Types

Motion control instructions can be used in the primary periodic task, in a priority-5 periodic task, or in a priority-16 periodic task. If you use motion control instructions in any other task, an error will occur when you build the program.

Task type	Applicability	Remarks
Primary periodic task	Applicable	<ul style="list-style-type: none"> <li>• Common instructions for which an axis or axes group is not specified.</li> <li>• Instructions for an axis or axes group assigned to the primary periodic task</li> </ul>
Periodic task (execution priority: 5)	Applicable <sup>*1</sup>	<ul style="list-style-type: none"> <li>• Common instructions for which an axis or axes group is not specified.</li> <li>• Instructions for an axis or axes group assigned to a priority-5 periodic task</li> </ul>
Periodic task (execution priority: 16)	Applicable <sup>*2</sup>	<ul style="list-style-type: none"> <li>• Common instructions for which an axis or axes group is not specified.</li> <li>• Instructions for an axis or axes group assigned to the primary periodic task</li> </ul>

Task type	Applicability	Remarks
Periodic task (execution priority: 17)	Not Applicable	
Periodic task (execution priority: 18)	Not Applicable	
Event task (execution priority: 8)	Not Applicable	
Event task (execution priority: 48)	Not Applicable	

\*1. You can use it only with NX701 CPU Units.

\*2. You cannot use it with NX102 CPU Units and NX1P2 CPU Units.

## Function Block Definitions

You can also use motion control instructions in user-defined function block definitions.



### Additional Information

Design efficiency is improved through program structuring, and program visibility is improved if a process with multiple operations is treated as a single function block.

## Master Control Regions

The area in a ladder diagram between the Master Control Start instruction (MC) and the Master Control End instruction (MCR) is the master control region.

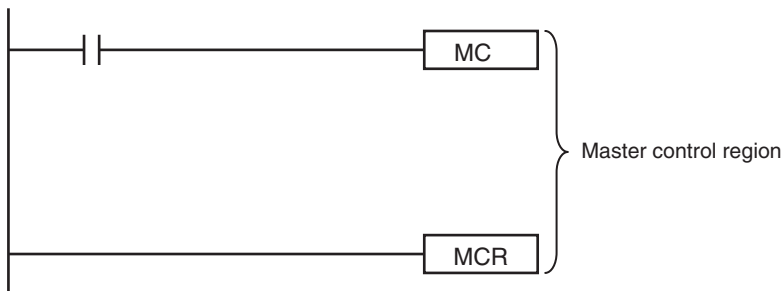

If a motion control instruction is located in the master control region, and the MC input condition is FALSE, the following will occur.

- Motion control instructions for which the input variable, *Enable* or *Execute*, is connected directly to the left bus bar are executed with a FALSE value for the input value.
- The values of the output parameters are updated as normal even when the *Enable* or *Execute* input variables to the motion control instructions are FALSE.



### Precautions for Correct Use

Master controls are not available in the ST language and inline ST in ladder diagram programs. Refer to *Master Control* in the *NJ/NX-series CPU Unit Software User's Manual (Cat. No. W501)* and *MC and MCR* in the *NJ/NX-series Instructions Reference Manual (Cat. No. W502)* for details.

● **Enable-type Motion Control Instructions**

- Instructions located in master control regions are equivalent to the programming shown on the right in the following figure.
- When G0 is TRUE, MC\_Power is executed normally.
- When G0 is FALSE, MC\_Power is executed as if the *Enable* input variable was FALSE.
- Instructions executed when G0 is TRUE is interrupted if G0 becomes FALSE during operation.

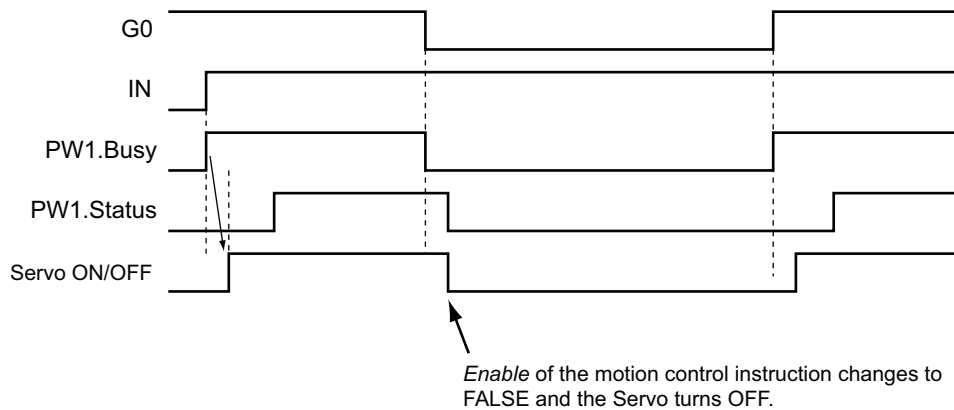
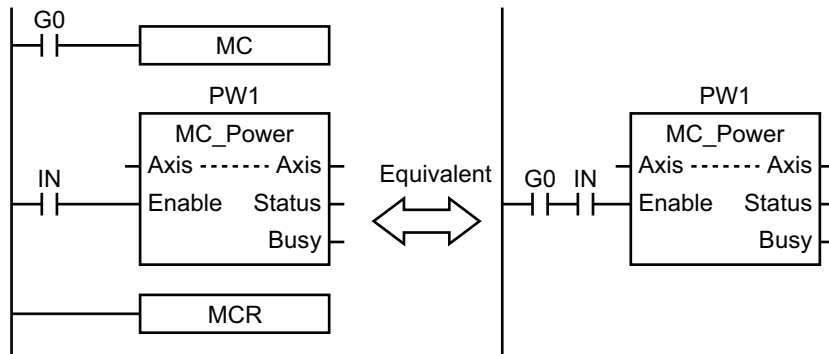

● **Execute-type Motion Control Instructions**

- Instructions located in master control regions are equivalent to the programming shown on the right in the following figure.
- When G0 is TRUE, MC\_MoveRelative is executed normally.
- When G0 is FALSE, MC\_MoveRelative is executed as if the *Execute* input variable was FALSE.
- Instructions executed when G0 is TRUE continue operation until completion, even if G0 changes to FALSE during operation. The values of output parameters are also updated in the normal way.

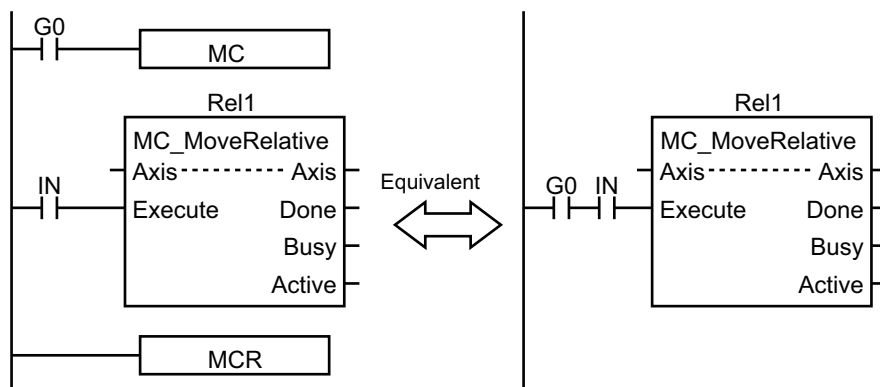

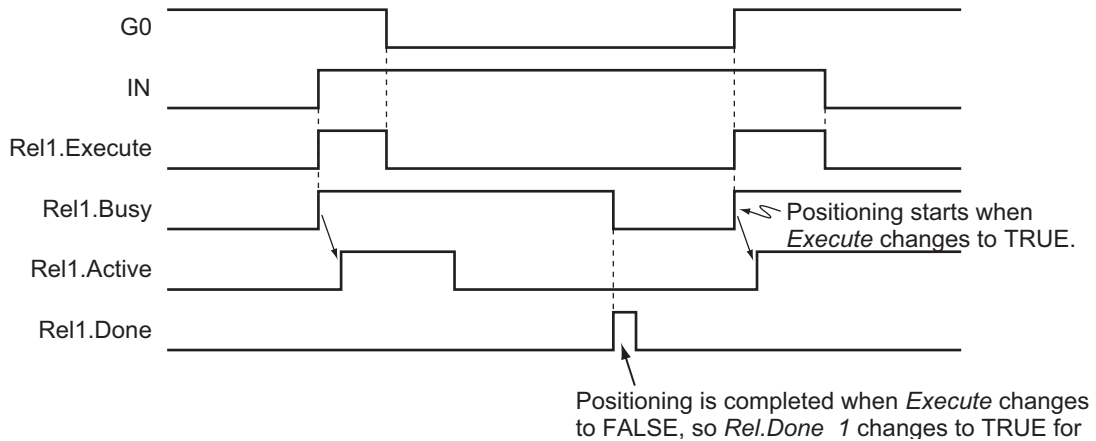

### Precautions for Correct Use

Execute-type motion control instructions are executed when G0 changes to TRUE. It is not recommended to use them in the master control region. If they must be used, be careful of the operation.

## Motion Control Instructions in ST Structure Instructions

This section describes the operation of motion control instructions when they are located in ST structures, such as IF, CASE, WHILE, or REPEAT structures.

When the evaluation result for the condition expression of an ST structure instruction is FALSE, the motion control instructions within the structure are not executed. Also, the values of the output variables are not updated.

If execution of an execute-type instruction is started and then the evaluation result changes to FALSE, processing is continued until it is completed. In that case, however, the values of the output variables are not updated.



### Precautions for Correct Use

The execution status of an execute-type instruction in an ST structure will not be clear if the evaluation result of the condition expression changes to FALSE during execution of the instruction. We therefore do not recommend using execution-type instructions in ST structures. If they must be used, be careful of the operation.



### Additional Information

To switch the execution of an execute-type instruction with the condition expression, place only the *Execute* input parameter in the ST structure. Place the execute-type instruction itself outside of the ST structure.

For details on the ST structure instructions, refer to the *NJ/NX-series Instructions Reference Manual (Cat. No. W502)*.

## Treatment of REAL and LREAL Data

REAL and LREAL are floating-point decimal data types.

This section describes how they are expressed and processed.

## ● REAL and LREAL Data Sizes

The data sizes of REAL data and LREAL data are different.  
REAL data has 32 bits and LREAL data has 64 bits.

## ● Floating-point Decimal Data Format

A real number in floating-point decimal format is expressed using a sign, exponent, and mantissa. When a real number is substituted in the following formulas, the value corresponding to "s" becomes the sign, "e" the exponent, and "f" the mantissa.

- REAL Data

$$\text{Number} = (-1)^s 2^{e-127} (1 + f \times 2^{-23})$$

- LREAL Data

$$\text{Number} = (-1)^s 2^{e-1023} (1 + f \times 2^{-52})$$

The floating-point data format conforms to the IEEE754 standards. The following formats are used.

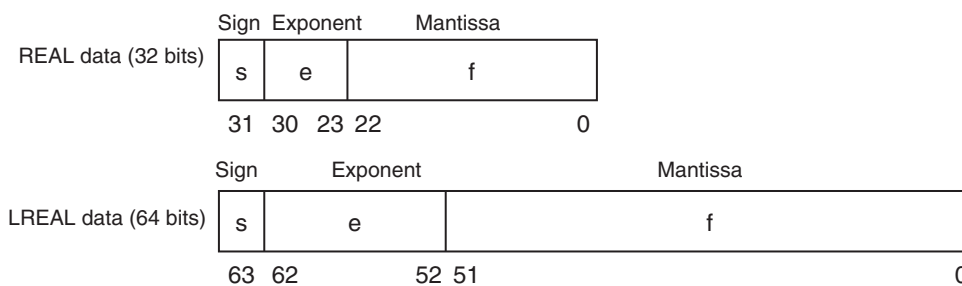

### Example: Expressing -86.625 as REAL Data

#### 1 Setting the Sign

The number is negative, so  $s = 1$ .

#### 2 Binary Expression

The number 86.625 is 1010110.101 as a binary number.

#### 3 Normalized Binary Expression

When the above number is normalized, it becomes  $1.010110101 \times 2^6$ .

#### 4 Exponent Expression

From the previous equation,  $e-127 = 6$ . Therefore  $e = 133$ .

The number 133 is 10000101 as a binary number. This expresses the exponent.

#### 5 Mantissa Expression

Numbers following the decimal point in 1.010110101 are 010110101.

This number is expressed using 23 bits, but here there are insufficient digits. Therefore zeros are added. The 23-bit figure becomes f.

Therefore  $f = 01011010100000000000000$ .

Therefore, -86.625 is expressed as shown in the following figure.

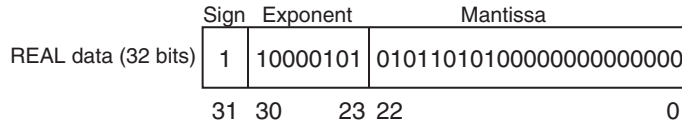

● **Valid Ranges**

The valid ranges of REAL and LREAL are shown in the following table.

Data type	-∞	Negative numbers	0	Positive number	+∞
REAL	-∞	-3.402823e+38 to -1.175495e-38	0	+1.175495e-38 to +3.402823e+38	+∞
LREAL	-∞	-1.79769313486231e+308 to -2.22507385850721e-308	0	+2.22507385850721e-308 to +1.79769313486231e+308	+∞

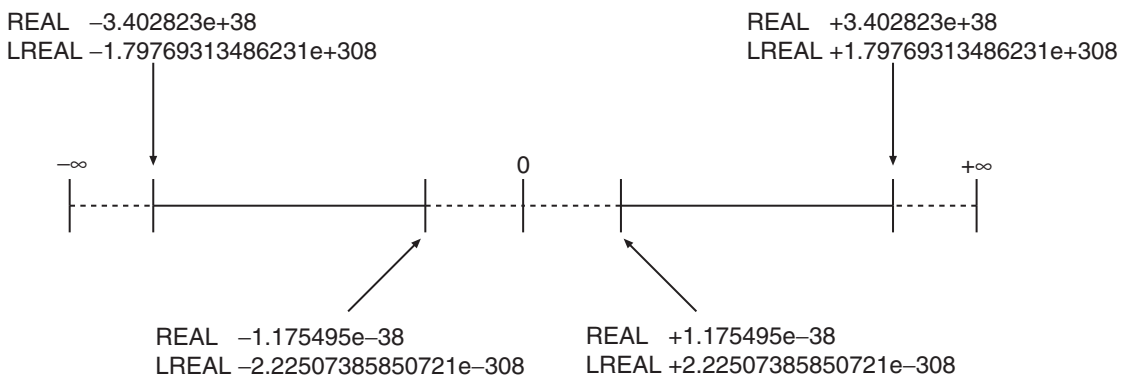

● **Special Numbers**

Positive infinity, negative infinity, +0, -0, and nonnumeric data are called special numbers.

Nonnumeric data is data that cannot be expressed in floating-point decimal format. They are not treated as numbers.

Mathematically, +0 and -0 both mean the same as 0, but in data processing it is treated differently.

A detailed explanation is given later.

The sign "s", exponent "e", and mantissa "f" for special numbers take on the following values.

Data type	Special number	Sign s	Exponent e	Mantissa f
REAL	+∞	0	255	0
	-∞	1	255	0
	+0	0	0	0
	-0	1	0	0
	Nonnumeric data	---	255	Not 0
LREAL	+∞	0	2047	0
	-∞	1	2047	0
	+0	0	0	0
	-0	1	0	0
	Nonnumeric data	---	2047	Not 0

● **Subnormal Numbers**

Numbers that are very close to 0 (with very small absolute values) cannot be expressed using the floating-point decimal format.

Subnormal numbers were introduced to expand the validity of numbers near 0.

Subnormal numbers can be used to express numbers whose absolute values are smaller than numbers expressed in the normal data format.



### Additional Information

Values expressed in the normal data format are called normalized numbers or normal numbers.

Numbers with exponent  $e = 0$  and mantissa  $f \neq 0$  are considered subnormal numbers and their values are expressed in the following manner.

- REAL Data

$$\text{Number} = (-1)^s 2^{-126} (f \times 2^{-23})$$

- LREAL Data

$$\text{Number} = (-1)^s 2^{-1022} (f \times 2^{-52})$$

### Example: Expressing $0.75 \times 2^{-127}$ as REAL Data

#### 1 Setting the Sign

The number is positive, so  $s = 0$ .

#### 2 Binary Expression

The number 0.75 is 0.11 as a binary number.

#### 3 Mantissa Calculation

From  $(0.11)_2 \times 2^{-127} = 2^{-126} (f \times 2^{-23})$ ,  $f = (0.11)_2 \times 2^{22}$ .

#### 4 Mantissa Expression

From the previous equation,  $f = 0110000000000000000000$ .

Therefore,  $0.75 \times 2^{-127}$  is expressed as shown in the following figure.

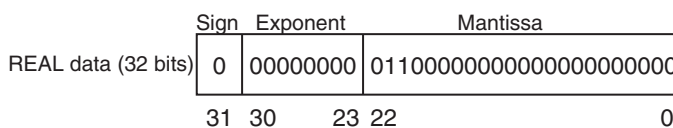

Subnormal numbers have fewer effective digits than normalized numbers. Therefore, if the calculation of a normalized number results in a subnormal number, or if an intermediate result is a subnormal number, the number of effective digits of the calculated result may be less than that of the normalized number.

## ● Data Processing

The floating-point decimal format is an approximate expression of a value, with a slight error from the actual value. There is a limit to the valid range of the value. For these reasons, the following process should be used for calculation.

### Rounding

If the actual value exceeds the effective digits of the mantissa, the value must be rounded according to the following rules.



- Of the values that can be expressed in floating-point decimal format, the value that is closest to the actual value is taken as the calculation result.
- If there are two values that are equally close to the actual value that can be expressed in floating-point decimal format, the value with the lowest significant 0 bit is taken as the calculation result.

When there are two values that are equally close to the actual value, the actual value is exactly in the middle of the two values.

### Overflows and Underflows

When the true absolute value exceeds the values that can be expressed by a floating-point data type, it is called an overflow. On the other hand, if the value is smaller than the values that can be expressed by a floating-point decimal data type, it is called an underflow.

- If the sign of the true value is positive, the processing result will be positive infinity when an overflow occurs.

If the sign of the true value is negative, the processing result will be negative infinity when an overflow occurs.

- If the sign of the true value is positive, the processing result will be +0 when an underflow occurs. If the sign of the true value is negative, the processing result will be -0 when an overflow occurs.

### Calculating with Special Numbers

The following rules apply when calculating with special numbers.

For details on special values, refer to *Special Numbers* on page 1-15.

- Adding positive infinity and negative infinity results in nonnumeric data.
- Subtracting infinity from infinity with the same signs results in nonnumeric data.
- Multiplying +0 by infinity or -0 by infinity results in nonnumeric data.
- Dividing +0 by +0, -0 by -0, or infinity by infinity results in nonnumeric data.
- Adding +0 and -0 results in +0.
- Subtracting +0 from +0, or -0 from -0 results in +0.
- Basic arithmetic operations including nonnumeric data results in nonnumeric data.
- Comparison instructions such as the CMP instruction treat +0 and -0 as the same value.
- If a nonnumeric number is included in a comparison, the comparison instruction always returns "Not Equal".



#### Precautions for Correct Use

Floating-point decimal (LREAL) variables are used to set electronic gears, target positions, and other parameters of motion control instructions in the MC Function Module. For this reason, calculation results contain rounding errors.

For example, if the MC\_MoveRelative (Relative Positioning) instruction is repeatedly executed, following error will accumulate.

If the accumulated error becomes a problem, set the command unit to pulses, or specify an absolute position with the MC\_MoveAbsolute (Absolute Positioning) instruction.

## 1-2-4 Multi-execution of Motion Control Instructions

This section describes executing multiple motion control instructions for the same axis within the same task period.

- In the following programming, the instruction instances, Move1 and Move2, start in the same task period when bit a turns ON.

- Instructions in a program are executed from the top. Therefore Move1 is started first, and then Move2 is started before Move1 is finished.
- This is considered multi-execution of the motion control instructions. In this example, **Blending** is used to execute Move2 in relation to Move1.

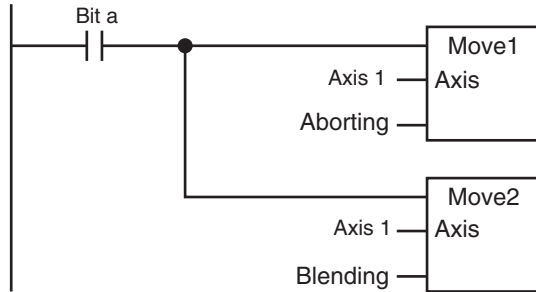

For details on multi-execution of motion control instructions, refer to the *NJ/NX-series CPU Unit Motion Control User's Manual (Cat. No. W507)*.



### Additional Information

If the MC\_SetOverride (Set Override Factors) instruction is executed simultaneously in the same way as the instructions shown above, the override value is valid even when it is placed on the bottom. When different override values are set with the MC\_SetOverride (Set Override Factors) instruction, the following type of programming is recommended.

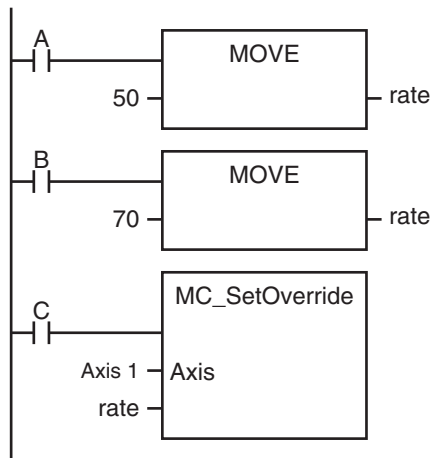

## 1-2-5 Online Editing of Motion Control Instructions

You can perform the following online editing operations for motion control instructions from the Sysmac Studio.

### Online editing operations

Deleting motion control instructions

Adding motion control instructions

Adding input variables, output variables, and in-out variables to motion control instructions

Changing input variables, output variables, and in-out variables in motion control instructions

Deleting input variables, output variables, and in-out variables in motion control instructions



### Precautions for Correct Use

If instructions to stop the axis motion, such as MC\_Stop or MC\_GroupStop, are deleted while the axis is still moving, the axis may not stop depending on the contents of the user program. Make sure that it is safe to use the online editing before using it for motion control instructions.

## 1-2-6 Changes in the Operating Mode of the CPU Unit

An NJ/NX-series CPU Unit has two operating modes: PROGRAM mode and RUN mode. This section describes the operation of the MC Function Module when the operating mode changes.

### Changes from RUN Mode to PROGRAM Mode

- The motion control instruction that is under execution will be aborted. The *CommandAborted* output variable remains FALSE, but the operation is the same as when *CommandAborted* is TRUE.
- If the axis is moving, it will decelerate to a stop at the maximum deceleration. The Servo ON/OFF status will continue.
- If saving the cam table is in progress for the Save Cam Table instruction, the save operation continues.
- If creation of the cam table is in progress for the Generate Cam Table instruction, the creation operation continues.
- Motion control instructions located in a priority 16 periodic task perform the above process after the END instruction in the task is executed.

### Changes from PROGRAM Mode to RUN Mode

- The output variables of the motion control instructions are cleared.
- The axis decelerates to a stop when the mode changes from RUN mode to PROGRAM mode. If the operating mode is changed back to RUN mode while the axis is decelerating, the output variables from the motion control instruction are cleared. Therefore, *CommandAborted* of the motion control instruction that was under execution remains FALSE.



### Additional Information

- To enable accessing output variables for motion control instructions even after the operating mode changes, assign variables that have output parameters with a Retain attribute. By accessing the assigned output parameter, you can access the output variable immediately before the operating mode changes.
- The Servo ON/OFF status will continue even if the operating mode is changed.



# 2

## Variables and Instructions

This section describes the variables and instructions for the Motion Control Function Module.

---

<b>2-1</b>	<b>Variables .....</b>	<b>2-2</b>
2-1-1	MC Common Variables .....	2-3
2-1-2	Axis Variables .....	2-4
2-1-3	Axes Group Variables .....	2-10
2-1-4	Input Variables for Motion Control Instructions .....	2-13
2-1-5	Output Variables for Motion Control Instructions .....	2-28
2-1-6	In-Out Variables for Motion Control Instructions .....	2-31
<b>2-2</b>	<b>Instructions .....</b>	<b>2-34</b>
2-2-1	Common Commands .....	2-34
2-2-2	Axis Commands .....	2-35
2-2-3	Axes Group Commands .....	2-37
<b>2-3</b>	<b>PDO Mapping .....</b>	<b>2-39</b>
2-3-1	Required Objects .....	2-39
2-3-2	Objects Required for Specific Instructions .....	2-40

## 2-1 Variables

There are two types of variables for the MC Function Module.

The first type is system-defined variables, which you use to monitor axis status and some of the parameter settings. System-defined variables that are used by the MC Function Module are called system-defined variables for motion control.

The second type is variables that are used to input arguments to motion control instructions and to output execution status from motion control instructions. Some input variables to motion control instruction are enumerated variables. With enumerated variables, selections are made from a set of enumerators.

This section describes the variable types, the valid ranges of motion control instruction input variables, and the enumerated variables.

### ● System-defined Variables for Motion Control

Level 1	Level 2	Level 3	Description
System-defined variables	System-defined variables for motion control	MC Common Variable	You can monitor the overall status of the MC Function Module.
		Axis Variables	You can monitor axis status and the settings of part of the axis parameters.
		Axes Group Variable	You can monitor axes group status and the settings of part of the axes group parameters.

For details on system-defined variables for motion control, refer to the *NJ/NX-series CPU Unit Motion Control User's Manual (Cat. No. W507)*.



#### Additional Information

Axis Variables and Axes Group Variables are system-defined variables.

When you use them in the user program, use the system-defined variable names (`_MC_AX[*]`, `_MC1_AX[*]`, `_MC2_AX[*]`, `_MC_GRP[*]`, `_MC1_GRP[*]`, and `_MC2_GRP[*]`).

You can also use the variable names that are set on the Sysmac Studio in the user program. You can change the names of any of the Axis Variables or Axes Group Variables that you create on the Sysmac Studio.

In the following example, the Axis Variable name for the axis that was added for the system-defined Axis Variable name of `_MC_AX[0]` has been changed to `MyAxis1` in the Sysmac Studio.

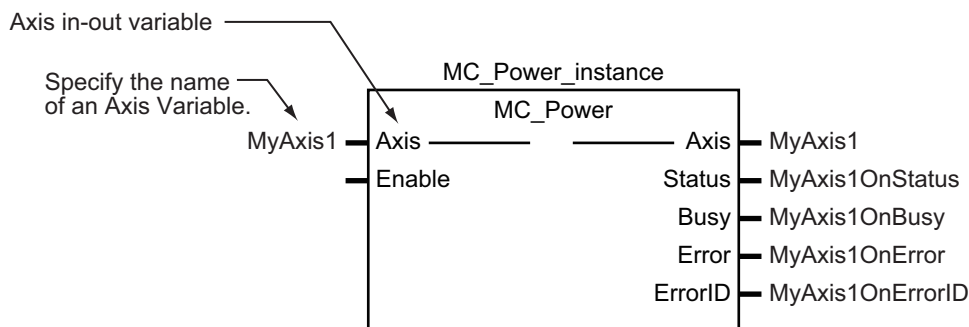

### ● Variables for Motion Control Instructions

Type	Outline
Input variables	Instruction arguments

Type	Outline
Output variables	Instruction execution status monitoring information
In-out variables	Specify data to process with the instruction



### Additional Information

- Data types that start with "\_e" are enumerations.
- Data types that start with "\_s" are structures.

For details on the data types that are handled by the MC Function Module, refer to the *NJ/NX-series CPU Unit Motion Control User's Manual (Cat. No. W507)*.

## 2-1-1 MC Common Variables

The variable name `_MC_COM` is used for the MC Common Variables. The data type is `_sCOMMON_REF`, which is a structure.

This section describes the configuration of the MC Common Variables and provides details on the members.

Name	Data type	Meaning	Function
<code>_MC_COM</code>	<code>_sCOMMON_REF</code>	MC Common Variable	
Status	<code>_sCOMMON_REF_STA</code>	MC Common Status	
RunMode	BOOL	MC Run	TRUE during MC Function Module operation.
TestMode	BOOL	MC Test Run	TRUE during test mode operation from the Sysmac Studio.
CamTableBusy	BOOL	Cam Table File Save Busy	TRUE while the Cam Table is being saved or on standby.
Generate-CamBusy*1	BOOL	Cam Table Creation Busy	TRUE while the cam table is being created.
PFaultLvl	<code>_sMC_REF_EVENT</code>	MC Common Partial Fault	
Active	BOOL	MC Common Partial Fault Occurrence	TRUE while there is an MC common partial fault.
Code	WORD	MC Common Partial Fault Code	Contains the code for an MC common partial fault. The upper four digits of the event code have the same value.
MFaultLvl	<code>_sMC_REF_EVENT</code>	MC Common Minor Fault	
Active	BOOL	MC Common Minor Fault Occurrence	TRUE while there is an MC common minor fault.
Code	WORD	MC Common Minor Fault Code	Contains the code for an MC common minor fault. The upper four digits of the event code have the same value.
Obsr	<code>_sMC_REF_EVENT</code>	MC Common Observation	
Active	BOOL	MC Common Observation Occurrence	TRUE while there is an MC common observation.
Code	WORD	MC Common Observation Code	Contains the code for an MC common observation. The upper four digits of the event code have the same value.

\*1. A CPU Unit with unit version 1.08 or later and Sysmac Studio version 1.09 or higher are required.

### 2-1-2 Axis Variables

The variable names of the system-defined Axis Variables are `_MC_AX[0..255]`, `_MC1_AX[0..255]`, and `_MC2_AX[0..255]`. The data type is `_sAXIS_REF`, which is a structure.

This section describes the configuration of the Axis Variables and provides details on the members using `_MC_AX[0..255]` as an example. The same information applies to `_MC1_AX[0..255]` and `_MC2_AX[0..255]`.



Name	Data type	Meaning	Function
<code>_MC_AX[0..255]</code>	<code>_sAXIS_REF</code>	Axis Variable	
Status	<code>_sAXIS_REF_STA</code>	Axis Status	
Ready	BOOL	Axis Ready-to-execute	TRUE when preparations for axis execution are finished and the axis is stopped. This variable gives the same status as <code>_MC_AX[*].Status.Standstill</code> (TRUE: standstill).
Disabled	BOOL	Axis Disabled	TRUE while the Servo is OFF for the axis. The following axis status are mutually exclusive. Only one of them can be TRUE at a time. Disabled, Standstill, Discrete, Continuous, Synchronized, Homing, Stopping, ErrorStop, or Coordinated
Standstill	BOOL	Standstill	TRUE while the Servo is ON for the axis.
Discrete	BOOL	Discrete Motion	TRUE while position control is executed toward the target position. This includes when the velocity is 0 because the override factor was set to 0 during a discrete motion.
Continuous	BOOL	Continuous Motion	TRUE during continuous motion without a target position. This state exists during velocity control and torque control. This includes when the velocity is 0 because the target velocity is set to 0 and when the velocity is 0 due to an override factor set to 0 during continuous motion.
Synchronized	BOOL	Synchronized Motion	TRUE during execution of synchronized control. This includes waiting for synchronization after changing to synchronized control instructions.
Homing	BOOL	Homing	TRUE when homing for the <code>MC_Home</code> or <code>MC_HomeWithParameter</code> instruction.
Stopping	BOOL	Deceleration Stopping	TRUE until the axis stops for a <code>MC_Stop</code> or <code>MC_TouchProbe</code> instruction. This includes when <code>Execute</code> is TRUE after the axis stops for an <code>MC_Stop</code> instruction. Axis motion instructions are not executed while decelerating to a stop. ( <code>CommandAborted</code> is TRUE)
ErrorStop	BOOL	Error Deceleration Stopping	This status exists when the axis is stopping or stopped for execution of the <code>MC_ImmediateStop</code> instruction or a minor fault (while <code>_MC_AX[*].MFAultLvl.Active</code> is TRUE (Axis Minor Fault Occurrence)). Axis motion instructions are not executed in this state. ( <code>CommandAborted</code> is TRUE)
Coordinated	BOOL	Coordinated Motion	TRUE when an axes group is enabled by a multi-axes coordinated control instruction.
Details	<code>_sAXIS_REF_DET</code>	Axis Control Status*1	

Name	Data type	Meaning	Function
Idle	BOOL	Idle	TRUE when processing is not currently performed for the command value, except when waiting for in-position state.* <sup>2</sup> <i>Idle</i> and <i>InPosWaiting</i> are mutually exclusive. They cannot both be TRUE at the same time.
InPosWaiting	BOOL	In-position Waiting	TRUE when waiting for in-position state. The in-position check is performed when positioning for the in-position check.
Homed	BOOL	Home Defined	TRUE when home is defined.* <sup>3</sup> TRUE: Home defined FALSE: Home not defined
InHome	BOOL	In Home Position	TRUE when the axis is in the range for home. It gives an AND of the following conditions. <ul style="list-style-type: none"> <li>• Home defined</li> <li>• The actual current position is in the zero position range with home as the center.</li> </ul> TRUE also when the zero position is passed by while the axis is moving in command status.
VelLimit* <sup>4</sup>	BOOL	Command Velocity Saturation	TRUE while the axis velocity is held to the maximum velocity during synchronized control.
Dir	_sAXIS_REF_DIR	Command Direction* <sup>5</sup>	
Posi	BOOL	Positive Direction	TRUE when there is a command in the positive direction.
Nega	BOOL	Negative Direction	TRUE when there is a command in the negative direction.
DrvStatus	_sAXIS_REF_STA_DRV	Servo Drive Status* <sup>6</sup>	
ServoOn	BOOL	Servo ON	TRUE when the Servomotor is powered.
Ready	BOOL	Servo Ready	TRUE when the Servo is ready.
MainPower	BOOL	Main Power	TRUE when the Servo Drive main power is ON.
P_OT	BOOL	Positive Limit Input	TRUE when the positive limit input is enabled.
N_OT	BOOL	Negative Limit Input	TRUE when the negative limit input is enabled.
HomeSw	BOOL	Home Proximity Input	TRUE when the home proximity input is enabled.
Home	BOOL	Home Input	TRUE when the home input is enabled.* <sup>7</sup>
ImdStop	BOOL	Immediate Stop Input	TRUE when the immediate stop input is enabled.
Latch1	BOOL	External Latch Input 1	TRUE when latch input 1 is enabled.
Latch2	BOOL	External Latch Input 2	TRUE when latch input 2 is enabled.
DrvAlarm	BOOL	Drive Error Input	TRUE while there is a Servo Drive error.
DrvWarning	BOOL	Drive Warning Input	TRUE while there is a Servo Drive warning.
ILA	BOOL	Drive Internal Limiting	TRUE when the Servo Drive limiting function actually limits the axis.* <sup>8</sup>
CSP	BOOL	Cyclic Synchronous Position (CSP) Control Mode	TRUE when the Servo is ON at the Servo Drive and the current mode is CSP Mode.* <sup>9</sup>

Name	Data type	Meaning	Function
CSV	BOOL	Cyclic Synchronous Velocity (CSV) Control Mode	TRUE when the Servo is ON at the Servo Drive and the current mode is CSV Mode.* <sup>9</sup>
CST	BOOL	Cyclic Synchronous Torque (CST) Control Mode	TRUE when the Servo is ON at the Servo Drive and the current mode is CST Mode.* <sup>9</sup>
Cmd	<u>s</u> AXIS_REF_CMD_DATA	Axis Command Value	
Pos	LREAL	Command Current Position	Contains the current value of the command position. (Unit: command units) When the Servo is OFF and the mode is not position control mode, this variable contains the actual current position.* <sup>10</sup>
Vel	LREAL	Command Current Velocity	Contains the current value of the command velocity. (Unit: command units/s) A plus sign is added when traveling in the positive direction, and a minus sign when traveling in the negative direction. The velocity is calculated from the difference with the command current position. When the Servo is OFF and the mode is not the position control mode, the velocity is calculated based on the actual current position.
AccDec	LREAL	Command Current Acceleration/Deceleration	Contains the current value of the command acceleration/deceleration rate. (Unit: command units/s <sup>2</sup> ) The acceleration/deceleration rate is calculated from the difference with the command current velocity. A plus sign is added for acceleration, and a minus sign is added for deceleration. Zero when the command acceleration/deceleration rate of the instruction under execution is 0.
Jerk	LREAL	Command Current Jerk	Contains the current value of the command jerk. (Unit: command units/s <sup>3</sup> ) A plus sign is added when the absolute value of acceleration/deceleration is increasing, and a minus sign is added when it is decreasing. Zero when the command acceleration/deceleration rate and command jerk of the instruction under execution is 0.
Trq	LREAL	Command Current Torque	Contains the current value of the command torque. (Unit: %) A plus sign is added when traveling in the positive direction, and a minus sign when traveling in the negative direction. Contains the same value as the actual current torque except in torque control mode.
Act	<u>s</u> AXIS_REF_ACT_DATA	Axis Current Value	
Pos	LREAL	Actual Current Position	Contains the actual current position. (Unit: command units)* <sup>10</sup>

Name	Data type	Meaning	Function
Vel	LREAL	Actual Current Velocity	Contains the actual current velocity. (Unit: command units/s) A plus sign is added when traveling in the positive direction, and a minus sign when traveling in the negative direction.
Trq	LREAL	Actual Current Torque	Contains the current value of the actual torque. (Unit: %) A plus sign is added when traveling in the positive direction, and a minus sign when traveling in the negative direction.
TimeStamp <sup>*11</sup>	ULINT	Time Stamp	Contains the time when the current position of the axis was updated. This variable is valid for an axis for which time stamping is operating. (Unit: ns)
MFaultLvl	_sMC_REF_EVENT	Axis Minor Fault	
Active	BOOL	Axis Minor Fault Occurrence	TRUE while there is an axis minor fault.
Code	WORD	Axis Minor Fault Code	Contains the code for an axis minor fault. The upper four digits of the event code have the same value.
Obsr	_sMC_REF_EVENT	Axis Observation	
Active	BOOL	Axis Observation Occurrence	TRUE while there is an axis observation.
Code	WORD	Axis Observation Code	Contains the code for an axis observation. The upper four digits of the event code have the same value.
Cfg	_sAXIS_REF_CFG	Axis Basic Settings <sup>*12</sup>	
AxNo	UINT	Axis Number	Contains the logical number of the axis. This number is accessed to recognize the axis number when accessing _sAXIS_REF.
AxEnable	_eMC_AXIS_USE	Axis Use	Shows if the axis is enabled or disabled. 0: _mcNoneAxis (Undefined Axis) 1: _mcUnusedAxis (Unused Axis) 2: _mcUsedAxis (Used Axis)
AxType	_eMC_AXIS_TYPE	Axis Type	Contains the axis type. I/O wiring is not required for virtual axes. 0: _mcServo (Servo Axis) 1: _mcEncdr (Encoder Axis) 2: _mcVirServo (Virtual Servo Axis) 3: _mcVirEncdr (Virtual Encoder Axis)
NodeAddress	UINT	Node Address	Contains the EtherCAT slave address. <sup>*13</sup> A value of 16#FFFF indicates that there is no address.
ExecID <sup>*14</sup>	UINT	Execution ID	Contains the task execution ID. 0: Not assigned to task (undefined axis) 1: Assigned to primary periodic task 2: Assigned to priority-5 periodic task
Scale	_sAXIS_REF_SCALE	Unit Conversion Settings <sup>*15</sup>	

Name	Data type	Meaning	Function
Num	UDINT	Command Pulse Count Per Motor Rotation	Contains the number of pulses per motor rotation for command positions. The command value is converted to a number of pulses based on the electronic gear ratio.
Den	LREAL	Work Travel Distance Per Motor Rotation	Contains the workpiece travel distance per motor rotation for command positions.*16
Units	_eMC_UNITS	Unit of Display	Contains the display unit for command positions. 0: _mcPls(pulse) 1: _mcMm(mm) 2: _mcUm(μm) 3: _mcNm(nm) 4: _mcDeg(degree) 5: _mcInch(inch)
CountMode*14	_eMC_COUNT_MODE	Count Mode	Contains the count mode. 0: _mcCountModeLinear (Linear Mode) 1: _mcCountModeRotary (Rotary Mode)
MaxPos*14	LREAL	Maximum current position	Contains the maximum value of the current position indication.*17
MinPos*14	LREAL	Minimum current position	Contains the minimum value of the current position indication.*18

\*1. Gives the control status of the command.

\*2. This also includes states where processing is performed while in motion at velocity 0, during following error counter resets, during synchronized control, and during multi-axes coordinated control motion.

\*3. Even if the variable is TRUE, the home must be defined again in the following cases.

- When you make a change in the position count settings or the unit conversion settings.
- If an error or erroneous operation occurs on the Servo Drive, which leads to loss of absolute position data. Examples of errors and erroneous operations include breaks of encoder cables and clear of absolute encoder data.

\*4. Use *VelLimit* only for a slave axis that is currently in synchronized control.

\*5. Gives the command travel direction.

\*6. Gives the status of the Servo Drive or other device.

\*7. This variable shows the status of the signal that is set for **Encoder Z-Phase Search of Digital inputs** in the **Detailed Settings** Area of the **Axis Basic Settings** Display of the Sysmac Studio. You may not be able to map this signal to a PDO for a servo driver from another manufacturer. Refer to the manual for the servo driver.

\*8. This variable shows the status of bit 11(internal limit active) of the Status word (6041 hex) mapped to a PDO. The condition for it to change to TRUE depends on the specifications of the Servo Drive. Refer to the manual for the servo driver. For the OMRON 1S-series Servo Drive or G5-series Servo Drive, this variable gives one of the following limits: torque limits, velocity limit, drive prohibit inputs, and software limits.

\*9. These variables are based on the value of the Modes of operation display (6061 hex) mapped to a PDO. The conditions for *CSP*, *CSV*, and *CST* to change to TRUE depend on the specifications of the Servo Drive. Refer to the manual for the servo driver.

If the Modes of Operation Display (6061 hex) is not mapped to a PDO, the values of these variables depend on the unit version of the CPU Unit as follows:

- For a CPU Unit with unit version 1.10 or later, they are TRUE when the status of the Statusword (6041 hex) that was mapped to a PDO is Operation Enabled.
- For a CPU Unit with unit version 1.09 or earlier, they are always FALSE.

\*10. Operation when process data communications is not established between the CPU Unit and an EtherCAT slave assigned to an axis or between the CPU Unit and an NX Unit depends on the version of the CPU Unit as follows:

- For CPU Unit version 1.10 or later, the actual current position and command current position in the Axis Variable will be the actual current position from just before process data communications changed to a non-established state.
- For CPU Unit version 1.09 or earlier, the actual current position and command current position in the Axis Variable will be either 0 or the lower limit value. The lower limit value is used when the Count Mode is set to Rotary Mode and 0 is not included in the positioning range.

- \*11. A CPU Unit with unit version 1.06 or later and Sysmac Studio version 1.07 or higher are required to use this variable.
- \*12. This variable shows the settings in the Axis Basic Settings.
- \*13. For an NX-series Position Interface Unit, this is the node address of the EtherCAT Coupler Unit under which the Position Interface Unit is mounted.
- \*14. A CPU Unit with unit version 1.10 or later and Sysmac Studio version 1.12 or higher are required to use this variable.
- \*15. This variable shows the settings of the electronic gear ratio.
- \*16. The parameter is disabled if you set to use a reducer in the unit conversion settings, which is the function added for CPU Units with unit version 1.11 or later. To confirm alternatively enabled parameters, i.e. **Work Travel Distance Per Rotation**, **Work Gear Ratio**, and **Motor Gear Ratio**, use the MC\_ReadAxisParameter (Read Axis Parameters) instruction.
- \*17. If the Count Mode is set to Linear Mode, the position just before an overflow is given. In Rotary Mode, the modulo maximum position is given.
- \*18. If the Count Mode is set to Linear Mode, the position just before an underflow is given. In Rotary Mode, the modulo minimum position is given.

### 2-1-3 Axes Group Variables

The variable names of the system-defined Axes Group Variables are `_MC_GRP[0..63]`, `_MC1_GRP[0..63]`, and `_MC2_GRP[0..63]`. The data type is `_sGROUP_REF`, which is a structure. This section describes the configuration of the Axes Group Variables and provides details on the members using `_MC_GRP[0..63]` as an example. The same information applies to `_MC1_GRP[0..63]` and `_MC2_GRP[0..63]`.

In the descriptions of functions, `_MC_AX[*]` is used as an example, but the same information applies to `_MC1_AX[*]` and `_MC2_AX[*]`.

Name	Data type	Meaning	Function
<code>_MC_GRP[0..63]</code>	<code>_sGROUP_REF</code>	Axes Group Variable	
Status	<code>_sGROUP_REF_STA</code>	Axes Group Status	
Ready	BOOL	Ready-to-execute	TRUE when the axes group is stopped and is ready to execute. The condition for being ready to execute is an AND of the following conditions. <ul style="list-style-type: none"> <li>• Execution of the MC_Stop instruction is not in progress for a composition axis.</li> <li>• <code>_MC_GRP[*].Status.Standby</code> (standby) is TRUE.</li> <li>• The Servo is ON for the composition axes.</li> <li>• <code>_MC_AX[*].Details.Homed</code> is TRUE (home defined) for the composition axes.</li> </ul>
Disabled	BOOL	Axes Group Disabled	TRUE when the axes group is disabled and stopped. The following axes group status are mutually exclusive. Only one of them can be TRUE at a time. Disabled, Standby, Moving, Stopping, or ErrorStop
Standby	BOOL	Standby	TRUE when the axes group motion instruction is stopped. This is not related to the Servo ON/OFF status of the composition axes in the axes group.

Name	Data type	Meaning	Function
Moving	BOOL	Moving	TRUE while an axes group motion instruction is executed toward the target position. This includes in-position waiting status and when the velocity is 0 for an override.
Stopping	BOOL	Deceleration Stopping	TRUE until the axes group stops for an MC_GroupStop instruction. This includes when <i>Execute</i> is TRUE after the axis stops for an MC_GroupStop instruction. Axes group motion instructions are not executed while decelerating to a stop. (CommandAborted is TRUE)
ErrorStop	BOOL	Error Deceleration Stopping	TRUE while the axes group is stopping or stopped for the MC_GroupImmediateStop instruction or during an axes group minor fault (when <i>_MC_GRP[*].MFaultLvl.Active</i> is TRUE). Axes group motion instructions are not executed in this state. (CommandAborted is TRUE)
Details	_sGROUP_REF_DET	Axes Group Control Status*1	
Idle	BOOL	Idle	TRUE when processing is not currently performed for the command value, except when waiting for in-position state. *2 <i>Idle</i> and <i>InPosWaiting</i> are mutually exclusive. They cannot both be TRUE at the same time.
InPosWaiting	BOOL	In-position Waiting	TRUE when any of the composition axes are waiting for in-position state. The in-position check performed when positioning for the in-position check.
Cmd	_sGROUP_REF_CMD_DATA	Axes Group Command Values	
Vel	LREAL	Command Interpolation Velocity	Contains the current value of the command interpolation velocity. The interpolation velocity is calculated from the difference with the interpolation command current position. A plus sign is added when traveling in the positive direction, and a minus sign is added when traveling in the negative direction. The value is 0 when the axes group is disabled.

Name	Data type	Meaning	Function
AccDec	LREAL	Command Interpolation Acceleration/Deceleration	Contains the current value of the command interpolation acceleration/deceleration. The interpolation acceleration/deceleration rate is calculated from the difference with the command interpolation velocity. A plus sign is added for acceleration, and a minus sign is added for deceleration. The value is 0 when the axes group is disabled, or when the command acceleration/deceleration rate of the current axes group motion instruction is 0.
MFaultLvl	_sMC_REF_EVENT	Axes Group Minor Fault	
Active	BOOL	Axes Group Minor Fault Occurrence	TRUE while there is an axes group minor fault.
Code	UINT	Axes Group Minor Fault Code	Contains the code for an axes group minor fault. The upper four digits of the event code have the same value.
Obsr	_sMC_REF_EVENT	Axes Group Observation	
Active	BOOL	Axes Group Observation Occurrence	TRUE while there is an axes group observation.
Code	WORD	Axes Group Observation Code	Contains the code for an axes group observation. The upper four digits of the event code have the same value.
Cfg	_sGROUP_REF_CFG	Axes Group Basic Settings	
GrpNo	UINT	Axes Group Number	Contains the logical number of the axes group. This number is accessed to recognize the axes group number when accessing _sGROUP_REF.
GrpEnable	_eMC_GROUP_USE	Axes Group Use	Shows if the axes group is enabled or disabled. 0: _mcNoneGroup (Undefined Axes Group) 1: _mcUnusedGroup (Unused Axes Group) 2: _mcUsedGroup (Used Axes Group)
ExecID <sup>*3</sup>	UINT	Execution ID	Contains the assigned task execution ID. 0: Not assigned to task (undefined axes group) 1: Assigned to primary periodic task 2: Assigned to priority-5 periodic task
Kinematics	_sGROUP_REF_KIM	Kinematics Transformation Settings <sup>*4</sup>	
GrpType	_eMC_GROUP_TYPE	Composition	Gives the axis composition for multi-axes coordinated control. 0: _mcXY (two axes) 1: _mcXYZ (three axes) 2: _mcXYZU (four axes)
Axis[0]	UINT	Axis Selection for Axis A0	Gives the axis number that is assigned to axis A0.
Axis[1]	UINT	Axis Selection for Axis A1	Gives the axis number that is assigned to axis A1.



Name	Data type	Meaning	Function
Axis[2]	UINT	Axis Selection for Axis A2	Gives the axis number that is assigned to axis A2.
Axis[3]	UINT	Axis Selection for Axis A3	Gives the axis number that is assigned to axis A3.

- \*1. Gives the control status of the command.
- \*2. This also includes states where processing is performed while in motion at a velocity of 0.
- \*3. A CPU Unit with unit version 1.10 or later and Sysmac Studio version 1.12 or higher are required to use this variable.
- \*4. Gives the definition of the kinematic conversions for the axes group.

## 2-1-4 Input Variables for Motion Control Instructions

The following tables list the input variables and the valid ranges for motion control instructions, and the valid ranges of enumerations.

### Input Variables

Name	Meaning	Data type	Valid range	Default	Description
Execute	Execute	BOOL	TRUE or FALSE	FALSE	The instruction is executed when the value of this variable changes to TRUE. Other input variables are also input when <i>Execute</i> changes to TRUE. If input values are changed, they will be updated when <i>Execute</i> changes to TRUE again. The output variables are valid as long as <i>Execute</i> remains TRUE even after the instruction is completed. Then, all output variables except for <i>Error</i> and <i>ErrorID</i> are disabled when <i>Execute</i> changes to FALSE. If <i>Execute</i> changes to FALSE before the instruction is completed, output variables are valid for at least one period.
Enable	Enable	BOOL	TRUE or FALSE	FALSE	The instruction function is enabled when the value of this variable changes to TRUE and disabled when it changes to FALSE. While <i>Enable</i> is TRUE, the other input variables are input every period. If <i>Enable</i> changes to FALSE, all output variables except for <i>Error</i> and <i>ErrorID</i> are disabled.

Name	Meaning	Data type	Valid range	Default	Description
PositiveEnable	Positive Direction Enable	BOOL	TRUE or FALSE	FALSE	<ul style="list-style-type: none"> <li>MC_MoveJog Instruction When this variable changes to TRUE, the axis starts moving in the positive direction. When it changes to FALSE, the axis stops moving. The <i>Velocity</i>, <i>Acceleration</i>, and <i>Deceleration</i> input variables to the MC_MoveJog instruction are read when <i>PositiveEnable</i> changes to TRUE.</li> <li>MC_SetTorqueLimit Instruction When this variable changes to TRUE, the positive torque limit is enabled. When it changes to FALSE, the positive torque limit is disabled.</li> </ul>
NegativeEnable	Negative Direction Enable	BOOL	TRUE or FALSE	FALSE	<ul style="list-style-type: none"> <li>MC_MoveJog Instruction When this variable changes to TRUE, the axis starts moving in the negative direction. When it changes to FALSE, the axis stops moving. The <i>Velocity</i>, <i>Acceleration</i>, and <i>Deceleration</i> input variables to the MC_MoveJog instruction are read when <i>NegativeEnable</i> changes to TRUE.</li> <li>MC_SetTorqueLimit Instruction When this variable changes to TRUE, the negative torque limit is enabled. When it changes to FALSE, the negative torque limit is disabled.</li> </ul>
BufferMode	Buffer Mode Selection	_eMC_BUFFER_MODE	0: _mcAborting 1: _mcBuffered 2: _mcBlendingLow 3: _mcBlendingPrevious 4: _mcBlendingNext 5: _mcBlendingHigh	0*1	Specifies the operation when executing more than one motion instruction. 0: Aborting 1: Buffered 2: Blending low 3: Blending previous 4: Blending next 5: Blending high
Velocity	Target Velocity	LREAL	Positive number*2	0	Specifies the target velocity. *3
Acceleration	Acceleration Rate	LREAL	Non-negative number	0	Specifies the acceleration rate. *4
Deceleration	Deceleration Rate	LREAL	Non-negative number	0	Specifies the deceleration rate. *4
Jerk	Jerk	LREAL	Non-negative number	0	Specifies the jerk. *5

Name	Meaning	Data type	Valid range	Default	Description
Distance	Travel Distance	LREAL	Negative number, positive number, or 0	0	Specifies the travel distance from the command current position.
		ARRAY [0..3] OF LREAL	Negative number, positive number, or 0	0	Specifies the target position for linear interpolation. *6
Position	Target Position	LREAL	Negative number, positive number, or 0	0	Specifies the absolute target position. *6
		ARRAY [0..3] OF LREAL	Negative number, positive number, or 0	0	Specifies the target position for linear interpolation. *6
VelFactor	Velocity Override Factor	LREAL	0 to 500	100	Specifies the velocity override factor. The valid range of the override factors is between 0.01 and 500.00. Values above 500.00 are treated as 500 and values less than 0.01 (including negative values) are treated as 0.01. The override factor will be 0 only when 0 is specified. The unit is %.
AccFactor (Reserved)	Acceleration/Deceleration Override Factor	LREAL	0 to 500	100	(Reserved)
JerkFactor (Reserved)	Jerk Override Factor	LREAL	0 to 500	100	(Reserved)
Reference-Type*7	Position Type Selection	_eMC_REFERENCE_TYPE	0: _mcCommand 1: _mcFeedback 2: _mcLatestCommand	0*1	Specifies the master axis input information. 0: Command position (value calculated in the previous task period*8) 1: Actual position (value obtained in the same task period*8) 2: Command position (value calculated in the same task period*8)
FeedDistance	Feed Distance	LREAL	Negative number, positive number, or 0	0	Specifies the travel distance after the interrupt feed input.
FeedVelocity	Feed Velocity	LREAL	Positive number	0	Specifies the travel target velocity after the interrupt feed input.
ErrorDetect	Error Detection Selection	BOOL	TRUE or FALSE	FALSE	Specifies whether to detect an error when there is no interrupt feed input. TRUE: Detect errors. FALSE: Do not detect errors.
Periodic	Periodic Mode	BOOL	TRUE or FALSE	FALSE	Specifies whether to execute the specified cam table periodically or only once. TRUE: Periodic FALSE: Non-periodic
StartMode	Start Mode	_eMC_START_MODE	0: _mcAbsolutePosition 1: _mcRelativePosition	0*1	Specifies the coordinates used by <i>MasterStartDistance</i> (master following distance). 0: Absolute position 1: Relative position

Name	Meaning	Data type	Valid range	Default	Description
StartPosition	Cam Table Start Position	LREAL	Negative number, positive number, or 0	0	Specifies the starting point of the cam table (0 phase) as an absolute position of the master axis.
MasterStart Distance	Master Following Distance	LREAL	Negative number, positive number, or 0	0	Specifies the position of the master axis when the following axis starts the cam motion. If you specify <b>Absolute Positioning</b> for <i>StartMode</i> , specify the absolute position of the master axis. If you specify <b>Relative Positioning</b> , specify the relative position of the master axis from <i>StartPosition</i> (Cam Table Start Position).
MasterScaling	Master Coefficient	LREAL	Positive value (> 0.0)	1.0	The master axis phase is extended or contracted using the specified scale.
SlaveScaling	Slave Axis Coefficient	LREAL	Positive value (> 0.0)	1.0	The slave axis displacement is extended or contracted using the specified scale.
MasterOffset	Master Offset	LREAL	Negative number, positive number, or 0	0	The phase of the master axis is shifted using the specified offset value.
SlaveOffset	Slave Offset	LREAL	Negative number, positive number, or 0	0	The displacement of the slave axis is shifted using the specified offset value.
CamTransition (Reserved)	Cam Transition Selection	_eMC_CAM_TRANSITION	0: _mcCTNone	0*1	(Reserved)
OutMode (Reserved)	Sync End Mode Selection	_eMC_OUT_MODE	0: _mcStop	0*1	(Reserved)
CamMonitorMode *9	Cam Monitor Mode Selection	_eMC_CAM_MONITOR_MODE	0: _mcCalcCamDistance-Diff	0 *1	Specifies information on the cam operation to be monitored. 0: Displacement following error calculation
Direction	Direction	_eMC_DIRECTION	0: _mcPositiveDirection 1: _mcShortestWay 2: _mcNegativeDirection 3: _mcCurrentDirection 4: _mcNoDirection	4/0 *1	Specifies the travel direction. 0: Positive direction 1: Shortest way 2: Negative direction 3: Current direction 4: No direction specified
Continuous (Reserved)	Continuation Mode Selection	BOOL	TRUE or FALSE	FALSE	(Reserved)
RatioNumerator	Gear Ratio Numerator	DINT*10	Positive or negative number*10	10,000	Specifies the electronic gear ratio numerator between the master and slave axes.
RatioDenominator	Gear Ratio Denominator	UDINT*11	Positive number	10,000	Specifies the electronic gear ratio denominator between the master and slave axes.
MasterSync Position	Master Sync Position	LREAL	Negative number, positive number, or 0	0	Specifies the absolute master sync position.

Name	Meaning	Data type	Valid range	Default	Description
SlaveSyncPosition	Slave Sync Position	LREAL	Negative number, positive number, or 0	0	Specifies the absolute slave sync position.
SlaveDistance	Slave Axis Travel Distance	LREAL	Negative number, positive number, or 0	0	Specifies the travel distance for the slave axis.
MasterDistance	Master Axis Travel Distance	LREAL	Non-negative number	0	Specifies the travel distance of the master axis.
MasterDistanceInACC	Master Distance in Acceleration	LREAL	Non-negative number	0	Specifies the travel distance of the master axis while the slave axis is accelerating.
MasterDistanceInDEC	Master Distance in Deceleration	LREAL	Non-negative number	0	Specifies the travel distance of the master axis while the slave axis is decelerating.
LinkOption	Synchronization Start Condition	_eMC_LINK-OPTION	0: _mcCommandExecution 1: _mcTriggerDetection 2: _mcMasterReach	0*1	Specifies the condition for the slave axis to synchronize with the master axis. 0: When instruction execution starts 1: When trigger is detected 2: When the master axis reaches the master following distance.
Combine-Mode	Combine Mode	_eMC_COMBINE_MODE	0: _mcAddAxes 1: _mcSubAxes	0*1	Specifies the combining method. 0: Addition 1: Subtraction
RatioNumeratorMaster (Reserved)	Master Axis Gear Ratio Numerator	DINT*10	Positive or negative number*10	10,00 0	Specifies the electronic gear ratio numerator between the master and slave axes.
RatioDenominatorMaster (Reserved)	Master Axis Gear Ratio Denominator	UDINT*11	Positive number	10,00 0	Specifies the denominator of the electronic gear ratio between the master and slave axes.
RatioNumeratorAuxiliary (Reserved)	Auxiliary Axis Gear Ratio Numerator	DINT*10	Positive or negative number*10	10,00 0	Specifies the numerator of the electronic gear ratio between the auxiliary and slave axes.
RatioDenominatorAuxiliary (Reserved)	Auxiliary Axis Gear Ratio Denominator	UDINT*11	Positive number	10,00 0	Specifies the denominator of the electronic gear ratio between the auxiliary and slave axes.
Reference-TypeMaster	Master Axis Position Type	_eMC_REFERENCE_TYPE	1: _mcFeedback 2: _mcLatestCommand	2*1	Specifies the position type of the master axis. 1: Actual position (value obtained in the same task period*8) 2: Command position (value calculated in the same task period*8)
Reference-TypeAuxiliary	Auxiliary Axis Position Type	_eMC_REFERENCE_TYPE	1: _mcFeedback 2: _mcLatestCommand	2*1	Specifies the position type of the auxiliary axis. 1: Actual position (value obtained in the same task period*8) 2: Command position (value calculated in the same task period*8)

Name	Meaning	Data type	Valid range	Default	Description
PhaseShift	Phase Shift Amount	LREAL	Negative number, positive number, or 0	0	Specifies the master phase shift amount. *6
Torque	Target Torque	LREAL	0 to 1000.0	300.0	Specify the target torque to output to the Servo Drive in increments of 0.1%. The target torque is specified as a percentage of the rated torque. The unit is %.
TorqueRamp	Torque Ramp	LREAL	Non-negative number	0	Specifies the rate of change in the torque from the current value to the target torque. The unit is %/s.
PositiveValue	Positive Torque Limit	LREAL	0.1 to 1000.0 or 0.0	300.0	Specifies the torque limit in the positive direction in increments of 0.1%. If a value that exceeds the <b>Maximum Positive Torque Limit</b> axis parameter, the positive torque will be the <b>Maximum Positive Torque Limit</b> . The value will be 0 if 0 or a negative value is specified.
NegativeValue	Negative Torque Limit	LREAL	0.1 to 1000.0 or 0.0	300.0	Specifies the torque limit in the negative direction in increments of 0.1%. If a value that exceeds the <b>Maximum Negative Torque Limit</b> axis parameter, the negative torque will be the <b>Maximum Negative Torque Limit</b> . The value will be 0 if 0 or a negative value is specified.
WindowOnly	Window Only	BOOL	TRUE or FALSE	FALSE	Specify whether to enable or disable the window mask.
FirstPosition	First Position	LREAL	Negative number, positive number, or 0	0	Specify the first position.
LastPosition	Last Position	LREAL	Negative number, positive number, or 0	0	Specify the last position.
StopMode	Stopping Mode Selection	_eMC_STOP_MODE	1: _mcImmediateStop 2: _mcImmediateStopFEReset 3: _mcFreeRunStop 4: _mcNonStop	4*1	Specifies the stopping method. 1: Perform an immediate stop 2: Perform an immediate stop and reset the following error counter 3: Perform an immediate stop and turn OFF the Servo 4: Do not stop
Relative (Reserved)	Relative Position Selection	BOOL	TRUE or FALSE	FALSE	(Reserved)
Execution-Mode (Reserved)	Execution Mode	_eMC_EXECUTION_MODE	0: _mcImmediately	0*1	(Reserved)
Permitted-Deviation	Permitted Following Error	LREAL	Non-negative number	0	Specifies the permitted maximum value for the following error between the master and slave axes.

Name	Meaning	Data type	Valid range	Default	Description
CmdPos-Mode	Command Current Position Count Selection	_eMC_CMDP OS_MODE	0: _mcCount	0*1	0: Use the actual current position and update the command current position. Home remains defined.
CoordSystem	Coordinate System	_eMC_CO- ORD_SYS- TEM	0: _mcACS	0*1	Specifies the coordinate system. 0: Axis coordinate system (ACS)
Transition-Mode	Transition Mode	_eMC_TRAN- SI- TION_MODE	0: _mcTMNone 10: _mcTMCornerSuper- imposed	0*1	Specifies the path of motion. 0: Transition disabled 10: Superimpose corners
MoveMode	Travel Mode	_eMC_MOVE _MODE	0: _mcAbsolute 1: _mcRelative	0*1	Selects the travel method. 0: Absolute positioning 1: Relative positioning
CircAxes	Circular Axes	ARRAY [0,1] OF UINT	0 to 3	0	Specifies the axes for circular interpolation. 0: Axis A0 1: Axis A1 2: Axis A2 3: Axis A3
CircMode	Circular Interpolation Mode	_eMC_CIRC_ MODE	0: _mcBorder 1: _mcCenter 2: _mcRadius	0*1	Specifies the method for circular interpolation. 0: Border point 1: Center 2: Radius
AuxPoint	Auxiliary Point	ARRAY [0,1] OF LREAL	Negative number, positive number, or 0	0	Specifies the border point, center, or radius.
EndPoint	End Point	ARRAY [0,1] OF LREAL	Negative number, positive number, or 0	0	Specifies the target position.
PathChoice	Path Choice	_eMC_CIRC_ PATHCHOICE	0: _mcCW 1: _mcCCW	0*1	Specifies the path direction. 0: CW 1: CCW
Parameter-Number	Parameter Number	_eMC_PA- RAME- TER_NUM- BER	0: _mcChkVel 1: _mcChkAcc 2: _mcChkDec 3: _mcPosiChkTrq* <sup>12</sup> 4: _mcNegaChkTrq* <sup>12</sup> 5: _mcFELmt 6: _mcChkFELmt 7: _mcSwLmtMode 8: _mcPosiSwLmt 9: _mcNegaSwLmt 10: _mcInPosTime 11: _mcInPosRange* <sup>13</sup> 12: _mcStartVel* <sup>14</sup>	0*1	Specifies the parameter to write. 0: Velocity Warning Value/Interpolation Velocity Warning Value 1: Acceleration Warning Value/Interpolation Acceleration Warning Value 2: Deceleration Warning Value/Interpolation Deceleration Warning Value 3: Positive Torque Warning Value 4: Negative Torque Warning Value 5: Following Error Over Value 6: Following Error Warning Value 7: Software Limits 8: Positive Software Limit 9: Negative Software Limit 10: In-position Check Time 11: In-position Range 12: Start Velocity

Name	Meaning	Data type	Valid range	Default	Description
HomingMode <sup>*15</sup>	Homing Method	_eMC_HOMING_MODE	0: _mcHomeSwTurnHomeSwOff 1: _mcHomeSwTurnHomeSwOn 4: _mcHomeSwOff 5: _mcHomeSwOn 8: _mcLimitInputOff 9: _mcHomeSwTurnHomeMask 11: _mcLimitInputOnly 12: _mcHomeSwTurnHoldingTime 13: _mcNoHomeSwHoldingHomeInput 14: _mcHomePreset	0 <sup>*1</sup>	Specify the new setting of the <b>Homing Method</b> . 0: Proximity reverse turn/home proximity input OFF 1: Proximity reverse turn/home proximity input ON 4: Home proximity input OFF 5: Home proximity input ON 8: Limit input OFF 9: Proximity reverse turn/home input mask distance 11: Limit inputs only 12: Proximity reverse turn/holding time 13: No home proximity input/holding home input 14: Zero position preset
AxisUse <sup>*16</sup>	Axis Use	_eMC_AXIS_USE	1: _mcUnusedAxis 2: _mcUsedAxis	1 <sup>*1</sup>	Specifies a used axis or an unused axis. 1: Unused axis 2: Used axis
EnableMask <sup>*17</sup>	Enable Tracks	WORD	16#0000 to FFFF	0	Specifies whether to enable or disable each track. There are a maximum of 16 tracks. Specify enable or disable for track 0 with bit 0 and track 15 with bit 15. 0: Disabled, 1: Enable
ValueSource (Reserved)	Input Information	_sMC_SOURCE	---	---	(Reserved)
TimeStamp <sup>*17</sup>	Time Stamp	ULINT	Non-negative number	0	Specifies the time stamp for which to calculate the position. A time stamp that is based on the time in a Digital Input Unit, Encoder Input Unit, or OMRON 1S-series Servo Drive with built-in EtherCAT communications that supports time stamp refreshing is specified. The unit is nanoseconds.
ExecID <sup>*18</sup>	Execution ID	UINT	2	2	Specifies the ID of the task with which the variable is synchronized. 2: Priority-5 periodic task
OffsetPosition <sup>*14</sup>	Position Offset	LREAL	Negative number, positive number, or 0	0	Specifies the position offset to add to the command current position. <sup>*6</sup>

- \*1. The default value for an enumeration variable is actually not the number, but the enumerator.
- \*2. You can use instructions, such as the MC\_MoveJog or MC\_MoveVelocity instruction, to set the velocity to 0.
- \*3. The unit is command units/s. The command unit is millimeters, micrometers, nanometers, degrees, inches, or pulses.
- \*4. The unit is command units/s<sup>2</sup>.
- \*5. The unit is command units/s<sup>3</sup>.
- \*6. This unit is command units.
- \*7. To use \_mcLatestCommand, the following condition must be met for the master and slave axes.  
The axis number set for the master axis in the system-defined variable for motion control must be lower than the axis number set for the slave axis in the system-defined variable for motion control.



- \*8. The task period is the primary period if the task is the primary periodic task and the task period of the priority-5 periodic task if the task is the priority-5 periodic task.
- \*9. If you use an NX102 CPU Unit, the CPU Unit with unit version 1.32 or later and Sysmac Studio version 1.28 or higher are required to use this variable.  
If you use an NX1P2 CPU Unit or NJ-series CPU Unit, the CPU Unit with unit version 1.21 or later and Sysmac Studio version 1.28 or higher are required to use this variable.
- \*10. A CPU Unit with unit version 1.02 or later and Sysmac Studio version 1.03 or higher are required to use this data type. For any previous version combinations, the data type is UINT and the valid range is positive numbers.
- \*11. A CPU Unit with unit version 1.02 or later and Sysmac Studio version 1.03 or higher are required to use this data type. For any previous version combinations, the data type is UINT.
- \*12. This parameter is enabled only for torque control.
- \*13. A CPU Unit with unit version 1.01 or later and Sysmac Studio version 1.02 or higher are required to use this variable.
- \*14. A CPU Unit with unit version 1.10 or later and Sysmac Studio version 1.12 or higher are required to use this variable.
- \*15. A CPU Unit with unit version 1.03 or later and Sysmac Studio version 1.04 or higher are required to use this variable.
- \*16. A CPU Unit with unit version 1.04 or later and Sysmac Studio version 1.05 or higher are required to use this variable.
- \*17. A CPU Unit with unit version 1.06 or later and Sysmac Studio version 1.07 or higher are required to use this variable.
- \*18. NX102 CPU Units, NX1P2 CPU Units, and NJ-series CPU Units do not have this input variable.

## Valid Range of Input Variables

This section gives the valid ranges of input variables to motion control instructions. Refer to individual instruction descriptions for the valid ranges for each instruction.

### ● BOOL Input Variables

Any value other than FALSE is treated as TRUE. For this reason, out-of-range errors do not occur.

### ● Enumerated (ENUM) Input Variables

Values that are outside of the valid range will result in an error.

### ● Input Variables Given as Full Range, Positive Number, or Negative Number

Operation when an input variable is set inside or outside the valid range is described in the following table.

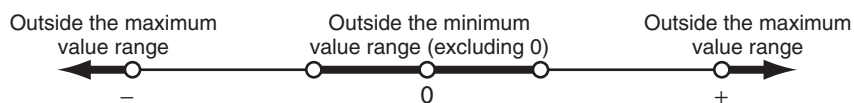

Name	Meaning	Valid range	Outside the maximum value range	Outside the minimum value range (excluding 0)
Velocity	Velocity	0, (-1 ≤ and ≤ - <b>Maximum Velocity</b> ), or (1 ≤ and ≤ <b>Maximum Velocity</b> )* <sup>1</sup>	Set to the <b>Maximum Velocity</b> for a positive number, and to the - <b>Maximum Velocity</b> for a negative number.* <sup>2</sup>	Set to 1 pulse/s when positive number, and -1 pulse/s when negative number.* <sup>2</sup>
Acceleration	Acceleration Rate	0 or (0.004 ≤ and ≤ <b>Maximum Acceleration</b> )* <sup>3</sup>	Set to the <b>Maximum Acceleration</b> . If the <b>Acceleration time</b> * <sup>4</sup> is less than 125 μs, it will always be 125 μs.	Set to 0.004 pulses/s <sup>2</sup> when positive number. If the <b>Acceleration time</b> * <sup>4</sup> is greater than 250 s, it will always be 250 s. Error when negative number.

Name	Meaning	Valid range	Outside the maximum value range	Outside the minimum value range (excluding 0)
Deceleration	Deceleration Rate	0 or $(0.004 \leq \text{and} \leq \text{Maximum Deceleration})^{*5}$	Set to the <b>Maximum Deceleration</b> . If the <b>Deceleration time</b> <sup>*4</sup> is less than 125 $\mu\text{s}$ , it will always be 125 $\mu\text{s}$ .	Set to 0.004 pulses/s <sup>2</sup> when positive number. If the <b>Deceleration time</b> <sup>*4</sup> is greater than 250 s, it will always be 250 s. Error when negative number.
Jerk	Jerk	0 or $(0.000016 \leq \text{and} \leq 25,600,000,000,000,000 \text{ pulses/s}^3)$	Set to 25,600,000,000,000,000 pulses/s <sup>3</sup> . If the <b>Acceleration jerk application time</b> <sup>*6</sup> or the <b>Deceleration jerk application time</b> <sup>*6</sup> is less than 125 $\mu\text{s}$ , it will always be 125 $\mu\text{s}$ .	Set to 0.000016 pulses/s <sup>3</sup> . If the <b>Acceleration jerk application time</b> <sup>*6</sup> or the <b>Deceleration jerk application time</b> <sup>*6</sup> is greater than 250 s, it will always be 250 s. Error when negative number.
Distance	Travel Distance	$(0 \times \text{FFFFFF0000000001}) \leq \text{and} \leq (0 \times \text{000000FFFFFFFFFFFF})$	Error	Values outside of the minimum value range do not occur.
Position	Command Position	$(0 \times \text{FFFFFF8000000000}) \leq \text{and} < (0 \times \text{0000007FFFFFFFFF} + 1)^{*7}$	Error	Values outside of the minimum value range do not occur.
VelFactor	Velocity Override Factor	0 or $0.01 \leq \text{and} \leq 500.00^{*8}$	Set to 500.00% if higher than 500.00%.	Set to 0.01% if less than 0.01%.
Velocity	Interpolation Velocity	$0.000\ 000\ 000\ 000\ 01 \leq \text{and} \leq \text{Maximum Interpolation Velocity}^{*9}$	Set to the <b>Maximum Interpolation Velocity</b> .	Set to 0.000 000 000 1 pulses/s.
Acceleration	Interpolation Acceleration	0 or $(0.000\ 000\ 000\ 000\ 04 \leq \text{and} \leq \text{Maximum Interpolation Acceleration})^{*10}$	Set to the <b>Maximum Interpolation Acceleration</b> . If the <b>Interpolation acceleration time</b> <sup>*11</sup> is less than 125 $\mu\text{s}$ , it will always be 125 $\mu\text{s}$ .	Set to 0.000 000 000 000 4 pulses/s <sup>2</sup> when positive number. If the <b>Interpolation acceleration time</b> <sup>*11</sup> is greater than 250 s, it will always be 250 s. Error when negative number.
Deceleration	Interpolation Deceleration	0 or $(0.000\ 000\ 000\ 000\ 04 \leq \text{and} \leq \text{Maximum Interpolation Deceleration})^{*12}$	Set to the <b>Maximum Interpolation Deceleration</b> . If the <b>Interpolation deceleration time</b> <sup>*11</sup> is less than 125 $\mu\text{s}$ , it will always be 125 $\mu\text{s}$ .	Set to 0.000 000 000 000 4 pulses/s <sup>2</sup> when positive number. If the <b>Interpolation deceleration time</b> <sup>*11</sup> is greater than 250 s, it will always be 250 s. Error when negative number.

Name	Meaning	Valid range	Outside the maximum value range	Outside the minimum value range (excluding 0)
Jerk	Interpolation Jerk	0 or (0.000 000 000 000 0016 ≤ and ≤ 51,200,000,000,000,000 pulses/s <sup>3</sup> )	Set to 51,200,000,000,000,000 pulses/s <sup>3</sup> . If the <b>Interpolation acceleration jerk application time</b> <sup>*13</sup> or the <b>Interpolation deceleration jerk application time</b> <sup>*13</sup> is less than 125 μs, it will always be 125 μs.	Set to 0.000 000 000 000 0016 pulses/s <sup>3</sup> . If the <b>Interpolation acceleration jerk application time</b> <sup>*13</sup> or the <b>Interpolation deceleration jerk application time</b> <sup>*13</sup> is greater than 250 s, it will always be 250 s. Error when negative number.

- \*1. The maximum value that you can set is as follows when the value is converted to pulses:
- For a CPU Unit with unit version 1.11 or later, the value is 2,147,483,647 [pulses/s].
  - For a CPU Unit with unit version 1.03 or later and 1.11 or earlier, the value is 500,000,000 [pulses/s].
  - For a CPU Unit with unit version 1.02 or earlier, the value is 400,000,000 [pulses/s].
- \*2. If a negative number or 0 is specified when negative numbers and 0 are not included in the effective range, an error occurs.
- \*3. The upper limit of the **Maximum Acceleration** in the axis parameters is 3,200,000,000,000 pulses/s<sup>2</sup>.
- \*4. Calculated as follows: Acceleration time = Velocity/Acceleration rate, Deceleration time = Velocity/Deceleration rate, and Acceleration/deceleration time = Acceleration time + Deceleration time.
- \*5. The upper limit of the **Maximum Deceleration** in the axis parameters is 3,200,000,000,000 pulses/s<sup>2</sup>.
- \*6. The acceleration jerk application time and the deceleration jerk application time are the times that jerk is applied. Calculated as follows: Acceleration jerk application time = Acceleration rate/Jerk and Deceleration jerk application time = Deceleration rate/Jerk.
- \*7. Position must be an absolute value in pulses and must be no more than 40 bits signed.
- \*8. The unit is %.
- \*9. The upper limit of the **Maximum Interpolation Velocity** in the axis parameters is the twice as high as the upper limit of the **Maximum Velocity** in the axis parameters.
- \*10. The upper limit of the **Maximum Interpolation Acceleration** in the axis parameters is 6,400,000,000,000 pulses/s<sup>2</sup>.
- \*11. Calculated as follows: Interpolation acceleration time = Interpolation velocity/Interpolation acceleration rate, Interpolation deceleration time = Interpolation velocity/Interpolation deceleration rate, and Acceleration/deceleration time = Acceleration time + Deceleration time.
- \*12. The upper limit of the **Maximum Interpolation Deceleration** in the axis parameters is 6,400,000,000,000 pulses/s<sup>2</sup>.
- \*13. The interpolation acceleration jerk application time and the interpolation deceleration jerk application time are the times that interpolation jerk is applied. Calculated as follows: Interpolation acceleration jerk application time = Interpolation acceleration rate/Interpolation jerk and Interpolation deceleration jerk application time = Interpolation deceleration rate/Interpolation jerk.

## Enumerations

This ENUM data is used by input variables to motion control instructions.

An enumeration input variable is not actually set to the number, but to the enumerator.

Data type	Valid range	Description	Corresponding instruction variable (Meaning)
_eMC_BUFFER_MODE	0: _mcAborting 1: _mcBuffered 2: _mcBlendingLow 3: _mcBlendingPrevious 4: _mcBlendingNext 5: _mcBlendingHigh	Specifies the operation for multi-execution of motion control instructions. 0: Aborting 1: Buffered 2: Blending low 3: Blending previous 4: Blending next 5: Blending high	BufferMode (Buffer Mode Selection)
_eMC_CIRC_MODE	0: _mcBorder 1: _mcCenter 2: _mcRadius	Specifies the method for circular interpolation. 0: Border point 1: Center 2: Radius	CircMode (Circular Interpolation Mode)
_eMC_CAM_TRANSITION	0: _mcCTNone	Specifies the slave axis command value output method when the cam is restarted. 0: No limit or correction	CamTransition (Cam Transition Selection)
_eMC_CIRC_PATHCHOICE	0: _mcCW 1: _mcCCW	Specifies the path direction. 0: CW 1: CCW	PathChoice (Path Choice)
_eMC_COMBINE_MODE	0: _mcAddAxes 1: _mcSubAxes	Specifies the combining method. 0: Addition 1: Subtraction	CombineMode (Combine Mode)
_eMC_COORD_SYSTEM	0: _mcACS	Specifies the coordinate system. 0: Axis coordinate system (ACS)	CoordSystem (Coordinate System)
_eMC_DIRECTION	0: _mcPositiveDirection 1: _mcShortestWay 2: _mcNegativeDirection 3: _mcCurrentDirection 4: _mcNoDirection	Specifies the direction of motion. 0: Positive direction 1: Shortest way 2: Negative direction 3: Current direction 4: No direction specified	Direction
_eMC_EXECUTION_MODE	0: _mcImmediately	(Reserved)	ExecutionMode (Execution Mode)
_eMC_LINKOPTION	0: _mcCommandExecution 1: _mcTriggerDetection 2: _mcMasterReach	Specifies the condition for the slave axis to synchronize with the master axis. 0: Start of instruction 1: When trigger is detected 2: When the master axis reaches the master following distance	LinkOption (Synchronization Start Condition)
_eMC_MOVE_MODE	0: _mcAbsolute 1: _mcRelative 2: _mcVelocity	Selects the travel method. 0: Absolute positioning 1: Relative positioning 2: Velocity control	MoveMode (Travel Mode)
_eMC_OUT_MODE	0: _mcStop	Specifies the mode to disable the synchronized control instruction. 0: Deceleration stop	OutMode (Sync End Mode Selection) (Reserved)

Data type	Valid range	Description	Corresponding instruction variable (Meaning)
_eMC_PARAMETER_NUMBER	0: _mcChkVel 1: _mcChkAcc 2: _mcChkDec 3: _mcPosiChkTrq* <sup>1</sup> 4: _mcNegaChkTrq* <sup>1</sup> 5: _mcFELmt 6: _mcChkFELmt 7: _mcSwLmtMode 8: _mcPosiSwLmt 9: _mcNegaSwLmt 10: _mcInPosTime 11: _mcInPosRange* <sup>2</sup> 12: _mcStartVel* <sup>3</sup>	Specifies the parameter to write. 0: Velocity Warning Value/Interpolation Velocity Warning Value 1: Acceleration Warning Value/Interpolation Acceleration Warning Value 2: Deceleration Warning Value/Interpolation Deceleration Warning Value 3: Positive Torque Warning Value 4: Negative Torque Warning Value 5: Following Error Over Value 6: Following Error Warning Value 7: Software Limits 8: Positive Software Limit 9: Negative Software Limit 10: In-position Check Time 11: In-position Range 12: Start Velocity	ParameterNumber (Parameter Number)
_eMC_SWLMT_MODE	0: _mcNonSwLmt 1: _mcCmdDecelerationStop 2: _mcCmdImmediateStop 3: _mcActDecelerationStop 4: _mcActImmediateStop	Enables and disables the software limits and specifies the Stop Mode. 0: Disable software limits 1: Deceleration stopping enabled for command position 2: Enable software limits and perform immediate stop for command position 3: Enable software limits and decelerate to stop for actual position 4: Enable software limits and perform immediate stop for actual position	SettingValue (Setting Value)
_eMC_REFERENCE_TYPE* <sup>4</sup>	0: _mcCommand 1: _mcFeedback 2: _mcLatestCommand	Specifies the position type. 0: Command position (value calculated in the previous task period* <sup>5</sup> ) 1: Actual position (value obtained in the same task period* <sup>5</sup> ) 2: Command position (value calculated in the same task period* <sup>5</sup> )	ReferenceType (Position Type Selection) ReferenceTypeMaster (Master Axis Position Type Selection) ReferenceTypeAuxiliary (Auxiliary Axis Position Type Selection)
_eMC_START_MODE	0: _mcAbsolutePosition 1: _mcRelativePosition	Specifies the coordinate system used by <i>MasterStartDistance</i> (master following distance). 0: Absolute position 1: Relative position	StartMode (Start Mode)
_eMC_STOP_MODE	0: _mcDecelerationStop 1: _mcImmediateStop 2: _mcImmediateStopFEReset 3: _mcFreeRunStop 4: _mcNonStop	Specifies the stopping method. 0: Deceleration stop 1: Perform an immediate stop 2: Perform an immediate stop and reset the following error counter 3: Turn OFF the Servo 4: Do not stop	StopMode (Stopping Mode Selection)

Data type	Valid range	Description	Corresponding instruction variable (Meaning)
_eMC_TRIGGER_LATCH_ID	0: _mcLatch1 1: _mcLatch2	Specifies which of the two latch functions to use. 0: Latch 1 1: Latch 2	LatchID
_eMC_CMDPOS_MODE	0: _mcCount	0: Use the actual current position and update the command current position. Home remains defined.	CmdPosMode (Command Current Position Count Selection)
_eMC_TRANSITION_MODE	0: _mcTMNone 10: _mcTMCornerSuperimposed	Specifies the path of motion. 0: Transition disabled 10: Superimpose corners	TransitionMode (Transition Mode)
_eMC_TRIGGER_MODE	0: _mcDrive 1: _mcController	Specifies the trigger mode. 0: Drive Mode 1: Controller Mode	Mode
_eMC_TRIGGER_INPUT_DRIVE	0: _mcEncoderMark 1: _mcEXT	Specifies the trigger signal in Drive Mode. 0: Z-phase signal 1: External input	InputDrive (Trigger Input Signal)
_eMC_HOMING_MODE* <sup>6</sup>	0: _mcHomeSwTurnHomeSwOff 1: _mcHomeSwTurnHomeSwOn 4: _mcHomeSwOff 5: _mcHomeSwOn 8: _mcLimitInputOff 9: _mcHomeSwTurnHomeMask 11: _mcLimitInputOnly 12: _mcHomeSwTurnHoldingTime 13: _mcNoHomeSwHoldingHomeInput 14: _mcHomePreset	Specify the new setting of the <b>Homing Method</b> . 0: Proximity reverse turn/home proximity input OFF 1: Proximity reverse turn/home proximity input ON 4: Home proximity input OFF 5: Home proximity input ON 8: Limit input OFF 9: Proximity reverse turn/home input mask distance 11: Limit inputs only 12: Proximity reverse turn/holding time 13: No home proximity input/holding home input 14: Zero position preset	---
_eMC_HOME_INPUT* <sup>6</sup>	0: _mcZPhase 1: _mcExternalSignal	Select the input to use for the home input signal. 0: Use Z-phase input as home. 1: Use external home input.	---
_eMC_LIMIT_REVERSE_MODE* <sup>6</sup>	0: _mcErrorStop 1: _mcRevImmediateStop 2: _mcRevDecelerationStop	Sets the stopping method when the limit input turns ON during homing. 0: No reverse turn/minor fault stop (Stop according to Limit Input Stop Method parameter.) 1: Reverse turn/immediate stop 2: Reverse turn/deceleration stop	---

Data type	Valid range	Description	Corresponding instruction variable (Meaning)
_eMC_CAM_CURVE <sup>*7</sup>	0: _mcConstantLine 1: _mcStraightLine 2: _mcParabolic 3: _mcModifiedConstantVel 4: _mcModifiedTrapezoid 5: _mcModifiedSine 6: _mcCycloidal 7: _mcTrapeclod 8: _mcReverseTrapeclod 9: _mcSimpleHarmonic 10: _mcDoubleHarmonic 11: _mcReverseDoubleHarmonic 12: _mcNC2Curve 13: _mcPolynomic3 14: _mcPolynomic5	Specifies the shape of the cam curve to the node point. 0: Constant 1: Straight line 2: Parabolic 3: Modified constant velocity 4: Modified trapezoid 5: Modified sine 6: Cycloidal 7: Trapeclod 8: Reverse trapeclod 9: Simple harmonic 10: Double harmonic 11: Reverse double harmonic 12: NC2 curve 13: Polynomic 3 14: Polynomic 5	Curve (Curve Shape)
_eMC_ACCDEC-COVER <sup>*7</sup>	0: _mcAccDecOverBuffer 1: _mcAccDecOverRapid 2: _mcAccDecOverErrorStop	Sets the operation for when the maximum acceleration/deceleration rate would be exceeded after excessive acceleration/deceleration during acceleration/deceleration control of the axis because stopping at the target position is given priority. 0: Use rapid acceleration/deceleration. (Blending is changed to Buffered.) <sup>*8</sup> 1: Use rapid acceleration/deceleration. 2: Minor fault stop <sup>*9</sup>	---
_eMC_REVERSE_MODE <sup>*7</sup>	0: _mcReverseModeDecelerationStop 1: _mcReverseModeImmediateStop	Specifies the operation for reversing rotation for multi-execution of instructions, re-execution of instructions, and interrupt feeding. 0: Deceleration stop 1: Immediate stop	---
_eMC_COUNT_MODE <sup>*7</sup>	0: _mcCountModeLinear 1: _mcCountModeRotary	Sets the count mode for the position. 0: Linear Mode (finite length) 1: Rotary Mode (infinite length)	---
_eMC_UNITS <sup>*7</sup>	0: _mcPls 1: _mcMm 2: _mcUm 3: _mcNm 4: _mcDeg 5: _mcInch	Sets the unit for command positions. 0: pulse 1: mm 2: $\mu\text{m}$ 3: nm 4: degree 5: inch	---
_eMC_CAM_MONITOR_MODE <sup>*10</sup>	0: _mcCalcCamDistanceDiff	Specifies information on the cam operation to be monitored. 0: Displacement following error calculation	---

\*1. This parameter is enabled only for torque control.



- \*2. A CPU Unit with unit version 1.01 or later and Sysmac Studio version 1.02 or higher are required to use this setting.
- \*3. A CPU Unit with unit version 1.10 or later and Sysmac Studio version 1.12 or higher are required to use this setting.
- \*4. To use `_mcLatestCommand`, the following condition must be met for the master and slave axes.  
When you use `mcLatestCommand`, the axis number set for the master axis in the system-defined variable for motion control must be lower than the axis number set for the slave axis in the system-defined variable for motion control.
- \*5. The task period is the primary period if the task is the primary periodic task and the task period of the priority-5 periodic task if the task is the priority-5 periodic task.
- \*6. A CPU Unit with unit version 1.03 or later and Sysmac Studio version 1.04 or higher are required to use this variable.
- \*7. A CPU Unit with unit version 1.08 or later and Sysmac Studio version 1.09 or higher are required to use this variable.
- \*8. For a CPU Unit with unit version 1.10 or later, blending is not changed to Buffered. For details, refer to the *NJ/NX-series CPU Unit Motion Control User's Manual (Cat. No. W507)*.
- \*9. For a CPU Unit with unit version 1.10 or later, the axis does not stop with an error and operation continues if blending operation is used. For details, refer to the *NJ/NX-series CPU Unit Motion Control User's Manual (Cat. No. W507)*.
- \*10. If you use an NX102 CPU Unit, the CPU Unit with unit version 1.32 or later and Sysmac Studio version 1.28 or higher are required to use this variable.  
If you use an NX1P2 CPU Unit or NJ-series CPU Unit, the CPU Unit with unit version 1.21 or later and Sysmac Studio version 1.28 or higher are required to use this variable.

### 2-1-5 Output Variables for Motion Control Instructions

The following table lists the output variables for motion control instructions.

Name	Meaning	Data type	Valid range	Description
Done	Done	BOOL	TRUE or FALSE	TRUE when the instruction is completed. At this time, output variables <i>Active</i> , <i>Error</i> , and <i>CommandAborted</i> are FALSE. <i>Done</i> will be TRUE for at least one period if the input variable <i>Execute</i> is FALSE when the instruction is completed. If <i>Execute</i> is TRUE, <i>Done</i> remains TRUE until <i>Execute</i> changes to FALSE.
Busy	Executing	BOOL	TRUE or FALSE	Changes to TRUE when an instruction is acknowledged.
Active	Controlling	BOOL	TRUE or FALSE	Changes to TRUE when the instruction is executed. This variable is TRUE while the instruction is actually controlling an axis or axes group. At this time, output variables <i>Done</i> , <i>Error</i> , and <i>CommandAborted</i> are FALSE.
Enabled	Enabled	BOOL	TRUE or FALSE	Changes to TRUE when busy.



Name	Meaning	Data type	Valid range	Description
CommandAborted	Instruction Aborted	BOOL	TRUE or FALSE	<p>TRUE when an instruction could not be executed or when it was aborted during execution.</p> <p>The instruction is not executed if there is an error with the target axis or axes group. Similarly, the instruction is not executed while the target axis or axes group is decelerating to a stop.</p> <p>The instruction is aborted when another instruction is executed, or if an error other than for this instruction occurs.</p> <p>At this time, output variables <i>Done</i>, <i>Active</i>, and <i>Error</i> change to FALSE. If the instruction is aborted while the input variable <i>Execute</i> is FALSE, <i>CommandAborted</i> will be TRUE for at least one period.</p> <p>If <i>Execute</i> or <i>Enable</i> is TRUE, <i>CommandAborted</i> remains TRUE until <i>Execute</i> or <i>Enable</i> changes to FALSE.</p>
Error	Error	BOOL	TRUE or FALSE	TRUE when there is an error caused by a mistake in an input variable or instruction processing. *1
ErrorID	Error Code	WORD	*2	Contains the error code when an error occurs. 16#0000 indicates normal operation.
Failure	Failure End	BOOL	TRUE or FALSE	TRUE when the instruction was not executed correctly.
Status	Servo ON	BOOL	TRUE or FALSE	TRUE when the device is ready for operation.
EndOfProfile	End of Cam Cycle	BOOL	TRUE or FALSE	Changes to TRUE when the cam table end point is executed.
Index	Index	UINT	Non-negative number	Contains the cam data index number.
StartSync	Following	BOOL	TRUE or FALSE	TRUE when acceleration/deceleration is started for synchronization and the device is ready for operation.
RecordedPosition	Latched Position	LREAL	Negative number, positive number, or 0	Contains the latched position. *3
Invalid	Excessive Following Error between Axes	BOOL	TRUE or FALSE	TRUE when the permitted following error between axes is exceeded.
DeviatedValue	Following Error between Axes	LREAL	Negative number, positive number, or 0	Contains the difference between the specified master and slave axes. *3
EndPointIndex	End Point Index	UINT	Non-negative number	Contains the cam table end point index.
MaxDataNumber	Maximum Number of Cam Data	UINT	Positive number	Contains the maximum cam data number.

Name	Meaning	Data type	Valid range	Description
InVelocity	Target Velocity Reached	BOOL	TRUE or FALSE	TRUE when the target velocity is reached.
InSync	In Sync	BOOL	TRUE or FALSE	TRUE when slave axis is synchronized to the master axis, or when the slave axis reaches the slave sync position.
InGear	Gear Ratio Achieved	BOOL	TRUE or FALSE	TRUE when the slave axis reaches the target velocity.
InCombination	Axes Combined	BOOL	TRUE or FALSE	TRUE when axes are combined.
InCam	Cam Motion	BOOL	TRUE or FALSE	TRUE when the cam table start point is executed.
InTorque	Target Torque Reached	BOOL	TRUE or FALSE	TRUE when the target torque is reached.
InFeed	Feeding	BOOL	TRUE or FALSE	TRUE while feeding after receiving a latch input.
InZone	In Zone	BOOL	TRUE or FALSE	TRUE when the axes position is within the zone range.
Valid <sup>*4</sup>	Enabled	BOOL	TRUE or FALSE	TRUE when the axes group is being controlled.
CommandPosition <sup>*4</sup>	Command Current Position	ARRAY [0..3] OF LREAL	Negative number, positive number, or 0	Contains the current value of the command position. <sup>*3</sup>
ActualPosition <sup>*4</sup>	Actual Current Position	ARRAY [0..3] OF LREAL	Negative number, positive number, or 0	Contains the actual current position. <sup>*3</sup>
InPosition <sup>*4</sup>	In Position	BOOL	TRUE or FALSE	TRUE when the actual current positions for all composition axes are within the in-position range of their target positions.
InOperation <sup>*5</sup>	In Operation	BOOL	TRUE or FALSE	TRUE when the operation for the instruction is in progress.
CalcPosition <sup>*5</sup>	Calculated Position	LREAL	Negative number, positive number, or 0	Contains the position for the specified time stamp. <sup>*3</sup>
ErrorParameter-Code <sup>*6</sup>	Parameter Detail Code	WORD	<sup>*2</sup>	Contains the attached information for some error codes. If the information is saved, the detail code of the parameter for which the error occurred is output.
ErrorNodePointIndex <sup>*6</sup>	Node Point Element Number	UINT	<sup>*2</sup>	Contains the attached information for some error codes. If the information is saved, the element number of the node point for which the error occurred is output.

Name	Meaning	Data type	Valid range	Description
OutputtedOffset-Position *7	Position Offset Output Value	LREAL	Negative number, positive number, or 0	Contains the position offset that was added to the command current position. The value is updated when <i>Active</i> is TRUE. Updating is stopped and the value is retained when <i>CommandAborted</i> or <i>Error</i> is TRUE.

- \*1. *Error* is not reset to FALSE until you execute one of the following instructions: MC\_Reset, MC\_GroupReset, or ResetMCErrror.  
This behavior is different from the PLCopen® specifications. With PLCopen® specifications, it changes to FALSE when *Execute* changes to FALSE.  
When *Error* is TRUE, the motion control instruction is not executed. Instructions are not executed after an error is cleared even if *Execute* is TRUE. The value of this variable must change from FALSE to TRUE to execute the instruction. Enable-type motion control instructions are executed whenever their *Enable* variable is TRUE.
- \*2. The upper four digits of the event code give the error code for ErrorID. Refer to the *NJ/NX-series Troubleshooting Manual (Cat. No. W503)* for the event codes.
- \*3. This unit is command units. The command unit is millimeters, micrometers, nanometers, degrees, inches, or pulses.
- \*4. A CPU Unit with unit version 1.01 or later and Sysmac Studio version 1.02 or higher are required to use this variable.
- \*5. A CPU Unit with unit version 1.06 or later and Sysmac Studio version 1.07 or higher are required to use this variable.
- \*6. A CPU Unit with unit version 1.08 or later and Sysmac Studio version 1.09 or higher are required to use this variable.
- \*7. A CPU Unit with unit version 1.10 or later and Sysmac Studio version 1.12 or higher are required to use this variable.



#### Additional Information

To enable accessing output variables for motion control instructions even after the operating mode is changed, assign variables that have output parameters with a retain attribute. By accessing the assigned output parameter, you can access the output variable immediately before the operating mode changed.

## 2-1-6 In-Out Variables for Motion Control Instructions

The following table lists the in-out variables for motion control instructions.

Name	Meaning	Data type	Valid range	Description
Axis	Axis	_sAXIS_REF	---	Specifies the axis.
AxesGroup	Axes Group	_sGROUP_REF	---	Specifies the axes group.
Auxiliary	Auxiliary Axis	_sAXIS_REF	---	Specifies the auxiliary axis.
Master	Master Axis	_sAXIS_REF	---	Specifies the master axis.
Slave	Slave Axis	_sAXIS_REF	---	Specifies the slave axis.
CamTable	Cam Table	ARRAY [0..N] OF _sMC_CAM_REF	---	Specifies the cam data structure _sMC_CAM_REF array variable as the cam table. *1
TriggerInput	Trigger Input Condition	_sTRIGGER_REF	---	Sets the trigger condition.
TriggerVariable	Trigger Variable	BOOL	TRUE or FALSE	Specifies a trigger input variable when the controller mode is specified with a trigger condition.
Target	Write Target	_sAXIS_REF or _sGROUP_REF	---	Specifies the axis or axes group for which to write a parameter.
SettingValue	Setting Value	Depends on the variable that is specified.	---	Specifies the value to write. The valid range follows the motion control parameter that is specified by ParameterNumber. *2 The default value is 0.

Name	Meaning	Data type	Valid range	Description
Axes <sup>*3</sup>	Axes Group Composition Axes	ARRAY [0..3] OF UINT	---	Specify the axis numbers of the new composition axes.
HomingParameter <sup>*4</sup>	Homing Parameter	_sHOMING_REF	---	Sets the homing parameter.
Switches <sup>*5</sup>	Switches	ARRAY [0..255] OF _sCAMSWITCH_REF	---	Specifies an array variable of _sCAMSWITCH_REF switch structures for use as switch ON/OFF pattern data. The array element numbers indicate the switch numbers.
Outputs <sup>*5</sup>	Output Signals	ARRAY [0..15] OF _sOUTPUT_REF	---	Specifies an array variable of _sOUTPUT_REF output signal structures for use as the output destinations for digital ON/OFF time outputs that are calculated based on switch ON/OFF pattern data. The array element numbers indicate the track numbers. You can specify this array variable as an in-out variable for a NX_AryDOutTimeStamp instruction to actually turn ON and OFF digital outputs.
TrackOptions <sup>*5</sup>	Track Options	ARRAY [0..15] OF _sTRACK_REF	---	Specifies an array variable of _sTRACK_REF track option structures for use as switch operating conditions. The array element numbers indicate the track numbers.
CamProperty <sup>*6</sup>	Cam Properties	_sMC_CAM_PROPERTY	---	Specifies a variable of _sMC_CAM_PROPERTY cam property structures. A user-defined variable with a data type of _sMC_CAM_PROPERTY or a cam property variable created on the Cam Editor of the Sysmac Studio is specified.
CamNodes <sup>*6</sup>	Cam Nodes	ARRAY [0..N] OF _sMC_CAM_NODE	---	Specifies an array variable of _sMC_CAM_NODE cam node structures. A user-defined variable with a data type of _sMC_CAM_NODE or a cam node variable created on the Cam Editor of the Sysmac Studio is specified. <sup>*7</sup>
AxisParameter <sup>*6</sup>	Axis Parameters	_sAXIS_PARAM	---	When writing, specifies the axis parameters to write. When reading, specifies the variable with a data type of _sAXIS_PARAM to which to write the axis parameters that are read.
CamMonitorValue <sup>*8</sup>	Cam Monitor Values	_sMC_CAM_MONITOR_DISTANCE	---	Outputs information on the cam operation. <sup>*9</sup>

\*1. *N* in the array variable is set automatically by the Sysmac Studio. Specify a cam data variable that was created on the Sysmac Studio.

\*2. For details on the data types of variables, refer to *Parameter Number Data Types and Valid Ranges* on page 5-14.

\*3. A CPU Unit with unit version 1.01 or later and Sysmac Studio version 1.02 or higher are required to use this variable.

\*4. A CPU Unit with unit version 1.03 or later and Sysmac Studio version 1.04 or higher are required to use this variable.

\*5. A CPU Unit with unit version 1.06 or later and Sysmac Studio version 1.07 or higher are required to use this variable.

\*6. A CPU Unit with unit version 1.08 or later and Sysmac Studio version 1.09 or higher are required to use this variable.

\*7. If you use a user-defined variable, create an array variable with a starting element number of 0 and a maximum of 358 array elements *N*.

- \*8. If you use an NX102 CPU Unit, the CPU Unit with unit version 1.32 or later and Sysmac Studio version 1.28 or higher are required to use this variable.  
If you use an NX1P2 CPU Unit or NJ-series CPU Unit, the CPU Unit with unit version 1.21 or later and Sysmac Studio version 1.28 or higher are required to use this variable.
- \*9. Information on the cam operation to be monitored is specified by *CamMonitorMode* (Cam Monitor Mode Selection).

## 2-2 Instructions

There are three types of motion control instructions. They are given in the following table.

Type	Outline
Common commands	Common instructions for the MC Function Module
Axis commands	Instructions for MC Function Module to perform single-axis control
Axes group commands	Instructions for MC Function Module to perform multi-axes coordinated control

For details on common commands, refer to *Section 5 Common Command Instructions* on page 5-1. For axis commands, refer to *Section 3 Axis Command Instructions* on page 3-1. For axes groups, refer to *Section 4 Axes Group Instructions* on page 4-1.

With the NX-series Position Interface Units, some motion control instructions are subject to functional restrictions and some motion control instructions cannot be used. Refer to the *NX-series Position Interface Units User's Manual (Cat. No. W524)* for details.

### 2-2-1 Common Commands

This section describes the common instructions for the MC Function Module.

The "Classification" column gives "Administration" for non-motion instructions and "Motion" for motion instructions.

The symbols have the following meanings.

P : Instructions defined in PLCopen® technical specifications.

O : Instructions defined for the MC Function Module.

Instruction	Instruction name	Outline	Classification	Single-axis*1
MC_SetCamTable-Property	Set Cam Table Properties	The end point index of the cam table that is specified in the input parameter is changed.	Administration O	
MC_SaveCamTable	Save Cam Table	Saves the cam table specified with the input parameter.	Administration O	
MC_Write	Write MC Setting	Writes part of the parameter settings for motion control.	Administration O	○
MC_GenerateCamTable*2	Generate Cam Table	Creates a cam table for the cam properties and cam nodes specified in the I/O variables.	Administration O	
MC_WriteAxisParameter*2	Write Axis Parameters	Writes the settings of the axis parameters in the motion control parameters.	Administration O	○
MC_ReadAxisParameter*2	Read Axis Parameters	Reads the settings of the axis parameters from the motion control parameters.	Administration O	○

\*1. Instructions usable with single-axis position control axis are marked with ○.

\*2. A CPU Unit with unit version 1.08 or later and Sysmac Studio version 1.09 or higher are required.

For details on the axis states due to instruction execution, refer to the *NJ/NX-series CPU Unit Motion Control User's Manual (Cat. No. W507)*.

## 2-2-2 Axis Commands

This section describes the instructions that are used to perform single-axis control for the MC Function Module.

The "Classification" column gives "Administration" for non-motion instructions and "Motion" for motion instructions.

The symbols have the following meanings.

P : Instructions defined in PLCopen® technical specifications.

O : Instructions defined for the MC Function Module.

Instruction	Instruction name	Outline	Classification		Single-axis *1
MC_Power	Power Servo	Makes the Servo Drive ready to operate.	Administration	P	O
MC_MoveJog	Jog	Performs jogging according to the specified target velocity.	Motion	O	O
MC_Home	Home	Operates the motor to determine home using the limit signals, home proximity signal, and home signal.	Motion	P	O
MC_HomeWith-Parameter *2	Home with Parameters	Sets the homing parameter and operates the motor to determine home. It uses the limit signals, home proximity signal, and home signal.	Motion	O	O
MC_Move	Positioning	Performs absolute positioning or relative positioning.	Motion	O	O
MC_MoveAbsolute	Absolute Positioning	Performs positioning for the specified absolute target position.	Motion	P	O
MC_MoveRelative	Relative Positioning	Performs positioning for the specified travel distance from the command current position.	Motion	P	O
MC_MoveVelocity	Velocity Control	Performs velocity control with the Position Control Mode of the Servo Drive.	Motion	P	O
MC_MoveZeroPosition	High-speed Home	Performs positioning with an absolute position of 0 as the target position to return to home.	Motion	O	O
MC_MoveFeed	Interrupt Feeding	Positioning is performed for the specified travel distance from the position where an external device triggers an interrupt input.	Motion	O	O
MC_Stop	Stop	Decelerates an axis to a stop.	Motion	P	O
MC_ImmediateStop	Immediate Stop	Stops an axis according to the stopping mode that is set with the <i>StopMode</i> (Stopping Mode Selection) input variable regardless of the status of the axis.	Motion	O	O
MC_SetPosition	Set Position	Changes the command current position or the actual current position as required for an axis.	Administration	P	O
MC_SetOverride	Set Override Factors	Changes the target velocity for an axis.	Administration	P	O
MC_ResetFollowingError	Reset Following Error Counter	Resets the following error between the command position and the actual position.	Motion	O	O
MC_CamIn	Start Cam Operation	Starts cam operation with a specified cam table.	Motion	P	
MC_CamOut	End Cam Operation	Ends cam operation for the axis specified with the input parameter.	Motion	P	
MC_CamMonitor *3	Cam Monitor	Monitors information on the cam operation.	Motion	O	

Instruction	Instruction name	Outline	Classification		Single-axis *1
MC_GearIn	Start Gear Operation	Specifies the gear ratio between the master axis and the slave axis and starts gear operation.	Motion	P	
MC_GearInPos	Positioning Gear Operation	Specifies the gear ratio between the master axis and the slave axis and starts electronic gear operation. Specifies the positions of the master axis and slave axis to start synchronization.	Motion	P	
MC_GearOut	End Gear Operation	Cancels MC_GearIn and MC_GearInPos instructions.	Motion	P	
MC_MoveLink	Synchronous Positioning	Performs positioning in sync with the specified master axis.	Motion	O	
MC_CombineAxes	Combine Axes	Outputs the sum or difference of the command positions of two axes as the command position.	Motion	O	
MC_Phasing	Shift Master Axis Phase	Shifts the phase of the master axis currently in synchronized control.	Motion	P	
MC_TorqueControl	Torque Control	Uses the Torque Control Mode of the Servo Drive to control the torque.	Motion	P	
MC_SetTorqueLimit	Set Torque Limit	Limits the torque output from the Servo Drive through the torque limit function of the Servo Drive.	Administration	O	○
MC_ZoneSwitch	Zone Monitor	Determines if the command position or actual current position of an axis is within a specified zone.	Administration	O	○
MC_TouchProbe	Enable External Latch	Records the position of an axis when a trigger signal occurs.	Administration	P	○
MC_AbortTrigger	Disable External Latch	Disables the current latch.	Administration	P	○
MC_AxesObserve	Monitor Axis Following Error	Monitors the deviation between the command positions or actual positions for the specified two axes to see if it exceeds the allowed value.	Administration	O	○
MC_SyncMoveVelocity	Cyclic Synchronous Velocity Control	Outputs the value set for the target velocity every task period *4 to the Servo Drive in Cyclic Synchronous Velocity Mode (CSV).	Motion	O	
MC_SyncMoveAbsolute *2	Cyclic Synchronous Absolute Positioning	Cyclically outputs the specified target positions for the axes.	Motion	O	○
MC_Reset	Reset Axis Error	Clears an axis error.	Administration	P	○
MC_ChangeAxisUse *5	Change Axis Use	Temporarily changes the <b>Axis Use</b> axis parameter.	Administration	P	○
MC_DigitalCamSwitch *6	Enable Digital Cam Switch	Turns a digital output ON or OFF according to the axis position.	Administration	P	○
MC_TimeStampToPos *6	Time Stamp to Axis Position Calculation	Calculates the position of the axis for the specified time stamp.	Administration	O	○
MC_PeriodicSyncVariables *7	Periodic Axis Variable Synchronization between Tasks	Periodically synchronizes Axes Variables between tasks.	Administration	O	



Instruction	Instruction name	Outline	Classification	Single-axis *1
MC_SyncOffsetPosition*8	Cyclic Synchronous Position Offset Compensation	Cyclically adds the specified position offset to the command current position of the slave axis in synchronized control, and outputs the result.	Motion	O
MC_OffsetPosition*3	Position Offset Compensation	Adds the specified position offset to the command current position of the slave axis in synchronized control with an acceleration/deceleration curve applied, and outputs the result.	Motion	O

- \*1. Instructions usable with single-axis position control axis are marked with O.
- \*2. A CPU Unit with unit version 1.03 or later and Sysmac Studio version 1.04 or higher are required to use this instruction.
- \*3. If you use an NX102 CPU Unit, the CPU Unit with unit version 1.32 or later and Sysmac Studio version 1.28 or higher are required to use this instruction.  
If you use an NX1P2 CPU Unit or NJ-series CPU Unit, the CPU Unit with unit version 1.21 or later and Sysmac Studio version 1.28 or higher are required to use this instruction.
- \*4. The task period is the primary period if the task is the primary periodic task and the task period of the priority-5 periodic task if the task is the priority-5 periodic task.
- \*5. A CPU Unit with unit version 1.04 or later and Sysmac Studio version 1.05 or higher are required to use this instruction.
- \*6. A CPU Unit with unit version 1.06 or later and Sysmac Studio version 1.07 or higher are required to use this instruction.
- \*7. You cannot use this instruction for an NX502 CPU Unit, NX102 CPU Unit, NX1P2 CPU Unit, or NJ-series CPU Unit.
- \*8. A CPU Unit with unit version 1.10 or later and Sysmac Studio version 1.12 or higher are required to use this instruction.

For details on the axis states due to instruction execution, refer to the *NJ/NX-series CPU Unit Motion Control User's Manual (Cat. No. W507)*.

Refer to the compliance list for items that conform to PLCopen® technical specifications.

The compliance list can be accessed on the PLCopen® website.

### 2-2-3 Axes Group Commands

This section describes the instructions to perform multi-axes coordinated control for the MC Function Module.

The "Classification" column gives "Group administration" for non-motion instructions and "Group motion" for motion instructions.

The symbols have the following meanings.

P : Instructions defined in PLCopen® technical specifications.

O : Instructions defined for the MC Function Module.

Instruction	Instruction name	Outline	Classification
MC_GroupEnable	Enable Axes Group	Enables an axes group.	Group administration P
MC_GroupDisable	Disable Axes Group	Disables an axes group.	Group administration P
MC_MoveLinear	Linear Interpolation	Performs linear interpolation.	Group motion O

Instruction	Instruction name	Outline	Classification	
MC_MoveLinearAbsolute	Absolute Linear Interpolation	Performs linear interpolation for the specified absolute position.	Group motion	P
MC_MoveLinearRelative	Relative Linear Interpolation	Performs linear interpolation for the specified relative position.	Group motion	P
MC_MoveCircular2D	Circular 2D Interpolation	Performs circular interpolation for two axes.	Group motion	O
MC_GroupStop	Group Stop	Decelerates all axes in an interpolated motion to a stop.	Group motion	P
MC_GroupImmediateStop	Axes Group Immediate Stop	Immediately stops all axes that are currently in interpolated motion with the method that is specified in the axis parameters.	Group motion	O
MC_GroupSetOverride	Set Group Overrides	Changes the blended target velocity during an interpolated motion.	Group administration	P
MC_GroupReadPosition*1	Read Axes Group Position	Gets the command current positions and the actual current positions of an axes group.	Group administration	O
MC_ChangeAxesInGroup*1	Change Axes in Group	Temporarily changes the <b>Composition Axes</b> axes group parameter.	Group administration	O
MC_GroupSyncMoveAbsolute*1	Axes Group Cyclic Synchronous Absolute Positioning	Cyclically outputs the specified target positions for the axes.	Group motion	O
MC_GroupReset	Group Reset	Clears axes group errors and axis errors.	Group administration	P

\*1. A CPU Unit with unit version 1.01 or later and Sysmac Studio version 1.02 or higher are required.

For details on the axes group states due to instruction execution, refer to the *NJ/NX-series CPU Unit Motion Control User's Manual (Cat. No. W507)*.

Refer to the compliance list for items that conform to PLCopen® technical specifications.

The compliance list can be accessed on the PLCopen® website.

## 2-3 PDO Mapping

You must map the objects that are required for the motion control functions that you will use to process data communications.

The PDO map lists all of the objects that are registered in advance.

If you use an OMRON 1S-series R88D-1SN□□□-ECT, R88D-1SAN□□□-ECT, G5-series R88D-KN□□□-ECT (version 2.1 or later), or R88D-KN□□□-ECT-L (version 1.1 or later) Servo Drive, it is not necessary to change the default PDO map on the Sysmac Studio.

<b>RxPDO: 261th Receive PDO Mapping (1704 hex)</b>	Controlword (6040 hex), Target Position (607A hex), Target Velocity (60FF hex), Target Torque (6071 hex), Modes of Operation (6060 hex), Touch Probe Function (60B8 hex), Max Profile Velocity (607F hex), Positive Torque Limit Value (60E0 hex), and Negative Torque Limit Value (60E1 hex)
<b>TxPDO: 259th Transmit PDO Mapping (1B02 hex)</b>	Error Code(603F hex), Status Word (6041 hex), Position Actual Value (6064 hex), Torque Actual Value (6077 hex), Modes of Operation Display (6061 hex), Touch Probe Status (60B9 hex), Touch Probe Pos1 Pos Value (60BA hex), Touch Probe Pos2 Pos Value (60BC hex), and Digital Inputs (60FD hex)



### Additional Information

To perform fully-closed control with an OMRON G5-series R88D-KN□□□-ECT Servo Drive, select 1701 hex or 1600 hex for RxPDO. For 1600 hex, the total size of objects should be 12 bytes or less (for version 2.1 or later).

For details on setting the PDO map, refer to the *NJ/NX-series CPU Unit Motion Control User's Manual (Cat. No. W507)*.

Refer to *I/O Entry Mappings* in the *NX-series Position Interface Units User's Manual (Cat. No. W524)* for information on using the NX-series Position Interface Units.

### 2-3-1 Required Objects

There are objects that are required for Servo axes and an object that is required for encoder axes. If even one of the required objects is not set, a Required Process Data Object Not Set error (error code: 3460 hex) occurs.

#### Servo Axes

The following objects must be set to use motion control instructions for a Servo axis.

Input/output	Function	Process data
Output	Control word	6040 hex
	Target position	607A hex
Input	Status word	6041 hex
	Position actual value	6064 hex



### Version Information

- If you are using a CPU Unit with unit version 1.10 or later, operation is as described in the following table depending on whether Modes of Operation (6060 hex) and Modes of Operation Display (6061 hex) are mapped.

	Modes of Operation Display (6061 hex) mapped	Modes of Operation Display (6061 hex) not mapped
Modes of Operation (6060 hex) mapped	<ul style="list-style-type: none"> <li>You can execute instructions that use CSP*<sup>1</sup>, CSV*<sup>2</sup>, or CST*<sup>3</sup>.</li> <li>The servo is OFF in any control mode other than CSP, CSV, or CST.</li> </ul>	<ul style="list-style-type: none"> <li>You can execute instructions that use CSP. If you execute any instruction that uses any other control mode, a Process Data Object Setting Missing error (error code: 3461 hex) occurs.</li> <li>The MC Function Module assumes that the CSP Servo Drive control mode is used. Command the Servo Drive to use CSP.</li> </ul>
Modes of Operation (6060 hex) not mapped	<ul style="list-style-type: none"> <li>You can execute instructions that use CSP. If you execute any instruction that uses any other control mode, a Process Data Object Setting Missing error (error code: 3461 hex) occurs.</li> <li>The servo is OFF in any control mode other than CSP.</li> </ul>	<ul style="list-style-type: none"> <li>You can execute instructions that use CSP. If you execute any instruction that uses any other control mode, a Process Data Object Setting Missing error (error code: 3461 hex) occurs.</li> </ul>

\*1. CSP is the Cyclic Synchronous Position Control Mode of the Servo Drive.

\*2. CSV is the Cyclic Synchronous Velocity Control Mode of the Servo Drive.

\*3. CST is the Cyclic Synchronous Torque Control Mode of the Servo Drive.

- If you are using a CPU Unit with unit version 1.09 or earlier and you are not using an OMRON 1S-series Servo Drive with built-in EtherCAT communications or G5-series Servo Drive with built-in EtherCAT communications for the servo axis, Modes of Operation (6060 hex) and Modes of Operation Display (6061 hex) are required.

## Encoder Axes

The following object must be set to use motion control instructions for an encoder axis.

Input/output	Function	Process data
Input	Position actual value	4010 hex

### 2-3-2 Objects Required for Specific Instructions

There are objects that you must set to use specific instructions.

There are settings required for both Servo axes and encoder axes.

If an object that is required for an instruction is not set, a Process Data Object Setting Missing error (error code: 3461 hex) occurs.

## Servo Axes

There are objects that you must set to use specific instructions for Servo axes.

Refer to the following tables and set the required objects.

There are no additional object settings required for Servo axis operation for any instructions that are not listed in the following table.

### ● Output Settings

Instruction	Function						
	Target velocity (60FF hex)	Target torque (6071 hex)	Modes of operation (6060 hex)* <sup>1</sup>	Touch probe function (60B8 hex)	Max. profile velocity (607F hex)	Positive torque limit value (60E0 hex)	Negative torque limit value (60E1 hex)
MC_Home				Conditionally required* <sup>2</sup>			
MC_HomeWithParameter				Conditionally required* <sup>2</sup>			
MC_MoveFeed				Conditionally required* <sup>3</sup>			
MC_MoveLink				Conditionally required* <sup>4</sup>			
MC_TorqueControl		Required	Required		Conditionally required* <sup>5</sup>		
MC_SetTorqueLimit						Required	Required
MC_TouchProbe				Conditionally required* <sup>2</sup>			
MC_SyncMoveVelocity	Required		Required				

\*1. If you set Modes of Operation (6060 hex), also set Modes of Operation Display (6061 hex). Normal operation is not possible if only one of these objects is set.

\*2. Setting is not required for Homing Operation Modes 11, 12, and 14.

\*3. Setting is required when *Mode* is set to **Drive Mode**.

\*4. Setting is required when *LinkOption* (Synchronization Start Condition) is set to **\_mcTriggerDetection** and *Mode* is set to **Drive Mode**.

\*5. This setting is checked only when an OMRON 1S-series Servo Drive with built-in EtherCAT communications or G5-series Servo Drive with built-in EtherCAT communications is used.

### ● Input Settings

Instruction	Function				
	Torque actual value (6077 hex)	Modes of operation display (6061 hex)* <sup>1</sup>	Touch probe status (60B9 hex)	Touch probe pos1 pos value (60BA hex)	Touch probe pos2 pos value (60BC hex)
MC_Home			Conditionally required* <sup>2</sup>	Conditionally required* <sup>2</sup>	
MC_HomeWithParameter			Conditionally required* <sup>2</sup>	Conditionally required* <sup>2</sup>	
MC_MoveFeed			Conditionally required* <sup>3</sup>	Conditionally required* <sup>4</sup>	Conditionally required* <sup>5</sup>

Instruction	Function				
	Torque actual value (6077 hex)	Modes of operation display (6061 hex) <sup>*1</sup>	Touch probe status (60B9 hex)	Touch probe pos1 pos value (60BA hex)	Touch probe pos2 pos value (60BC hex)
MC_MoveLink			Conditionally required <sup>*6</sup>	Conditionally required <sup>*7</sup>	Conditionally required <sup>*8</sup>
MC_TorqueControl	Required	Required			
MC_TouchProbe			Conditionally required <sup>*3</sup>	Conditionally required <sup>*4</sup>	Conditionally required <sup>*5</sup>
MC_SyncMoveVelocity		Required			

- \*1. If you set Modes of Operation Display (6061 hex), also set Modes of Operation (6060 hex). Normal operation is not possible if only one of these objects is set.
- \*2. Setting is not required for Homing Operation Modes 11, 12, and 14.
- \*3. Setting is required when *Mode* is set to **Drive Mode**.
- \*4. Setting is required when *Mode* is set to **Drive Mode** and *LatchID* is set to **\_mcLatch1** (Latch 1).
- \*5. Setting is required when *Mode* is set to **Drive Mode** and *LatchID* is set to **\_mcLatch2** (Latch 2).
- \*6. Setting is required when *LinkOption* (Synchronization Start Condition) is set to **\_mcTriggerDetection** and *Mode* is set to **Drive Mode**.
- \*7. Setting is required when *LinkOption* (Synchronization Start Condition) is set to **\_mcTriggerDetection**, *Mode* is set to **Drive Mode**, and *LatchID* is set to **\_mcLatch1** (Latch 1).
- \*8. Setting is required when *LinkOption* (Synchronization Start Condition) is set to **\_mcTriggerDetection**, *Mode* is set to **Drive Mode**, and *LatchID* is set to **\_mcLatch2** (Latch 2).

## Encoder Axes

There are objects that you must set to use specific instructions for encoder axes.

Refer to the following tables and set the required objects.

There are no additional object settings required for encoder axis operation for any instructions that are not listed in the following table.

### ● Output Settings

Instruction	Function	
	Touch probe function (4020 hex)	Software Switch of Encoder's Input Slave (4020 hex)
MC_TouchProbe	Conditionally required <sup>*1</sup>	Conditionally required <sup>*2</sup>

- \*1. Setting is required when *Mode* is set to **Drive Mode**.
- \*2. Setting is required when an OMRON GX-series encoder slave is used and *Mode* is set to **Drive Mode**.

### ● Input Settings

Instruction	Function			
	Touch probe status (4030 hex)	Touch probe pos1 pos value (4012 hex)	Touch probe pos2 pos value (4013 hex)	Status of Encoder's Input Slave (4030 hex)
MC_TouchProbe	Conditionally required <sup>*1</sup>	Conditionally required <sup>*2</sup>	Conditionally required <sup>*3</sup>	Conditionally required <sup>*4</sup>

- \*1. Setting is required when *Mode* is set to **Drive Mode**.
- \*2. Setting is required when *Mode* is set to **Drive Mode** and *LatchID* is set to **\_mcLatch1** (Latch 1).

- \*3. Setting is required when *Mode* is set to **Drive Mode** and *LatchID* is set to **\_mcLatch2** (Latch 2).
- \*4. Setting is required when an OMRON GX-series encoder slave is used and *Mode* is set to **Drive Mode**.





# 3

## Axis Command Instructions

This section describes the instructions that are used to perform single-axis control for the MC Function Module.

---

MC_Power .....	3-3
MC_MoveJog .....	3-8
MC_Home .....	3-18
MC_HomeWithParameter .....	3-41
MC_Move .....	3-47
MC_MoveAbsolute .....	3-52
MC_MoveRelative .....	3-79
MC_MoveVelocity .....	3-87
MC_MoveZeroPosition .....	3-103
MC_MoveFeed .....	3-110
MC_Stop .....	3-139
MC_ImmediateStop .....	3-148
MC_SetPosition .....	3-153
MC_SetOverride .....	3-160
MC_ResetFollowingError .....	3-166
MC_CamIn .....	3-173
MC_CamOut .....	3-232
MC_CamMonitor .....	3-237
MC_GearIn .....	3-246
MC_GearInPos .....	3-267
MC_GearOut .....	3-290
MC_MoveLink .....	3-295
MC_CombineAxes .....	3-319
MC_Phasing .....	3-331
MC_TorqueControl .....	3-338

<b>MC_SetTorqueLimit</b> .....	<b>3-351</b>
<b>MC_ZoneSwitch</b> .....	<b>3-358</b>
<b>MC_TouchProbe</b> .....	<b>3-364</b>
<b>MC_AbortTrigger</b> .....	<b>3-386</b>
<b>MC_AxesObserve</b> .....	<b>3-390</b>
<b>MC_SyncMoveVelocity</b> .....	<b>3-397</b>
<b>MC_SyncMoveAbsolute</b> .....	<b>3-407</b>
<b>MC_Reset</b> .....	<b>3-414</b>
<b>MC_ChangeAxisUse</b> .....	<b>3-418</b>
<b>MC_DigitalCamSwitch</b> .....	<b>3-424</b>
<b>MC_TimeStampToPos</b> .....	<b>3-444</b>
<b>MC_PeriodicSyncVariables</b> .....	<b>3-456</b>
<b>MC_SyncOffsetPosition</b> .....	<b>3-464</b>
<b>MC_OffsetPosition</b> .....	<b>3-474</b>

# MC\_Power

The MC\_Power instruction makes a Servo Drive ready to operate.

Instruction	Name	FB/ FUN	Graphic expression	ST expression
MC_Power	Power Servo	FB		<pre>MC_Power_instance (   Axis :=parameter,   Enable :=parameter,   Status =&gt;parameter,   Busy =&gt;parameter,   Error =&gt;parameter,   ErrorID =&gt;parameter );</pre>

## Variables

### Input Variables

Name	Meaning	Data type	Valid range	Default	Description
Enable	Enable	BOOL	TRUE or FALSE	FALSE	The device is ready for operation when the value of this variable is TRUE, and not ready when it is FALSE.

### Output Variables

Name	Meaning	Data type	Valid range	Description
Status	Servo ON	BOOL	TRUE or FALSE	TRUE when the device is ready for operation.
Busy	Executing	BOOL	TRUE or FALSE	TRUE when the instruction is acknowledged.
Error	Error	BOOL	TRUE or FALSE	TRUE while there is an error.
ErrorID	Error Code	WORD	*1	Contains the error code when an error occurs. A value of 16#0000 indicates normal execution.

\*1. The upper four digits of the event code give the error code for ErrorID. Refer to the *NJ/NX-series Troubleshooting Manual (Cat. No. W503)* for the event codes.

### ● Output Variable Update Timing

Name	Timing for changing to TRUE	Timing for changing to FALSE
Status	When the specified axis becomes ready for operation.	<ul style="list-style-type: none"> <li>When operation ready status for the specified axis is cleared.</li> <li>When <i>Error</i> changes to TRUE.</li> </ul>
Busy	When <i>Enable</i> changes to TRUE.	<ul style="list-style-type: none"> <li>When <i>Enable</i> changes to FALSE.</li> <li>When <i>Error</i> changes to TRUE.</li> </ul>

Name	Timing for changing to TRUE	Timing for changing to FALSE
Error	When there is an error in the execution conditions or input parameters for the instruction.	When the error is cleared.

## In-Out Variables

Name	Meaning	Data type	Valid range	Description
Axis	Axis	_sAXIS_REF	---	Specifies the axis. *1

- \*1. Specify a user-defined Axis Variable that was created in the Axis Basic Settings of the Sysmac Studio (default: MC\_Axis\*) or a system-defined axis variable name (\_MC\_AX[\*], \_MC1\_AX[\*], or \_MC2\_AX[\*]).  
 If you use Sysmac Studio version 1.29 or higher, you can specify the system-defined axis variable name for AT specification of a user-defined variable. This will allow you to specify the user-defined variable.  
 If you use Sysmac Studio version 1.28 or lower, do not specify any user-defined variable created in the variable table.

## Function

- When *Enable* changes to TRUE, the axis specified by *Axis* is made ready to operate. You can control the axis when it is ready to operate.
- When *Enable* changes to FALSE, the ready status is cleared for the axis specified by *Axis*. You cannot control the axis after the ready status is cleared because it will not acknowledge operation commands. Also, an error occurs if a motion command is executed for an axis for which the ready status is cleared. You can execute the MC\_Power (Power Servo) and MC\_Reset (Reset Axis Error) instructions even for axes that are not ready.
- You can use this instruction to disable the operation of axes while they are in motion. In this case, *CommandAborted* will change to TRUE. Output of the operation command will stop and the axis will not longer be ready for operation.
- If home is not defined for a Servomotor with an absolute encoder, compensation is performed using the **absolute encoder home offset** to define home when the axis is ready to operate. For a CPU Unit with unit version 1.10 or later, home is also defined when EtherCAT process data communications change from a non-established to an established state. For details on the **absolute encoder home offset**, refer to the *NJ/NX-series CPU Unit Motion Control User's Manual (Cat. No. W507)*.



### Precautions for Correct Use

- You can use this instruction for servo axes and virtual servo axes. If the instruction is used for encoder axes or virtual encoder axes, an error will occur.
- This instruction provides different functions when it is executed for an NX-series Pulse Output Unit. Refer to the *NX-series Position Interface Units User's Manual (Cat. No. W524)* for details.
- **Executing this Instruction for the Master Axis of Synchronized Control**  
 When master axis operation is disabled for a vertical axis, the position of the master axis may change rapidly. This may cause the motion of the slave axis to change rapidly. Take suitable measures to prevent the slave axis from moving rapidly, such as applying a brake to the master axis or leaving master axis operation enabled until after synchronized control is completed.



### Additional Information

Execution of an execute-type motion control instruction is started when the power flow that is connected to the *Execute* input changes to TRUE, and continues until the control operation for the instruction is completed. Even if master control is reset after execution of the instruction is started, execution of the instruction is continued until the control operation for the instruction is completed.

To interlock an execute-type motion control instruction, place the MC\_Power (Power Servo) instruction inside the master control region, as shown in the following figure. That will ensure that the Servo is turned OFF when *MC\_On* changes to FALSE.

Master control started.

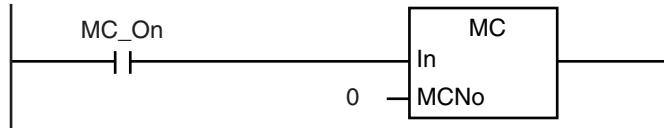

Servo turned ON.

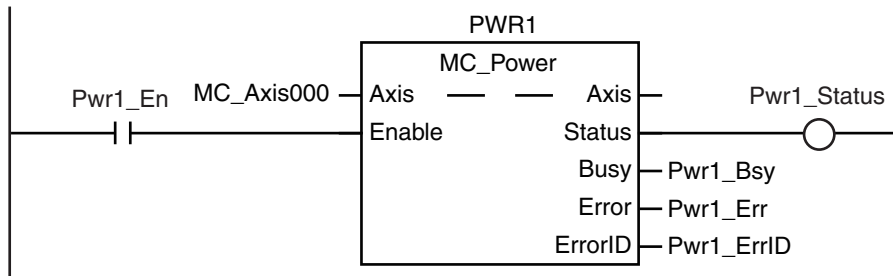

Master control ended.

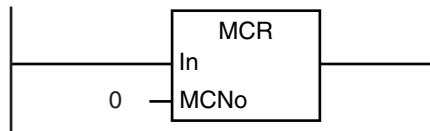

### ● Relation to CPU Unit Operating Modes

If an axis is placed in ready status during RUN mode, the ready status will continue even if the operating mode changes to PROGRAM mode.

### ● Deleting Instruction with Online Editing

If an axis is placed in ready status, the ready status will continue even if the instruction is deleted during online editing.

## Timing Charts

- When *Enable* changes to TRUE, *Busy* (Executing) changes to TRUE to indicate that the instruction was acknowledged.
- After the axis becomes ready for operation, *Status* (Servo ON) changes to TRUE.
- When *Enable* changes to FALSE, *Busy* (Executing) changes to FALSE. *Status* (Servo ON) changes to FALSE when ready status is cleared. *Status* (Servo ON) outputs the axis ready status regardless of whether *Enable* is TRUE or FALSE.

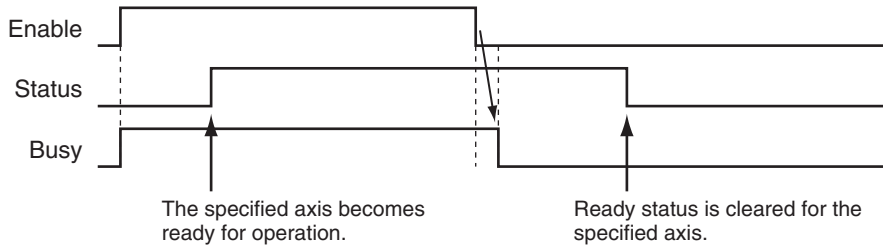

#### Precautions for Correct Use

- *Status* (Servo ON) will not change to TRUE until *Enable* changes to TRUE and the processing is finished at the axis. Make sure that *Status* (Servo ON) changes to TRUE before moving the axis.
- Write the user program to confirm that EtherCAT communications are established before you execute motion control instructions. This is particularly important when starting axis operation immediately after you turn ON the power supply to the Controller. Also, include interlocks in the user program that detect errors in EtherCAT communications during operation.

## Re-execution of Motion Control Instructions

You cannot re-execute motion instructions with enable-type inputs.

## Multi-execution of Motion Control Instructions

For details on multi-execution of motion control instructions, refer to the *NJ/NX-series CPU Unit Motion Control User's Manual (Cat. No. W507)*.

### ● Multi-execution of MC\_Power Instructions



#### Precautions for Correct Use

Do not execute the MC\_Power (Power Servo) instruction for an axis that is already enabled for another instance of the MC\_Power (Power Servo) instruction. Normally, use only one MC\_Power (Power Servo) instruction for each axis.

If another MC\_Power (Power Servo) instruction is executed for the same axis, the last instruction takes priority.

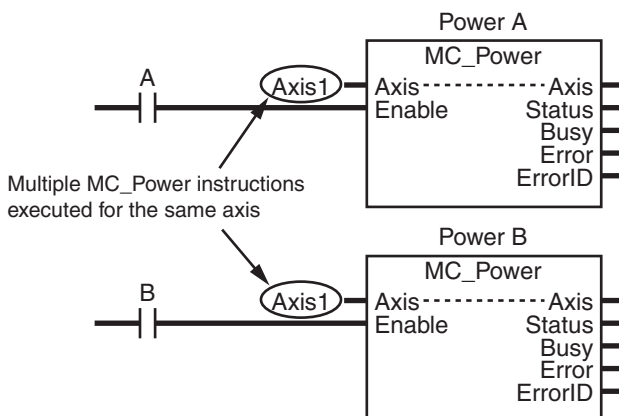

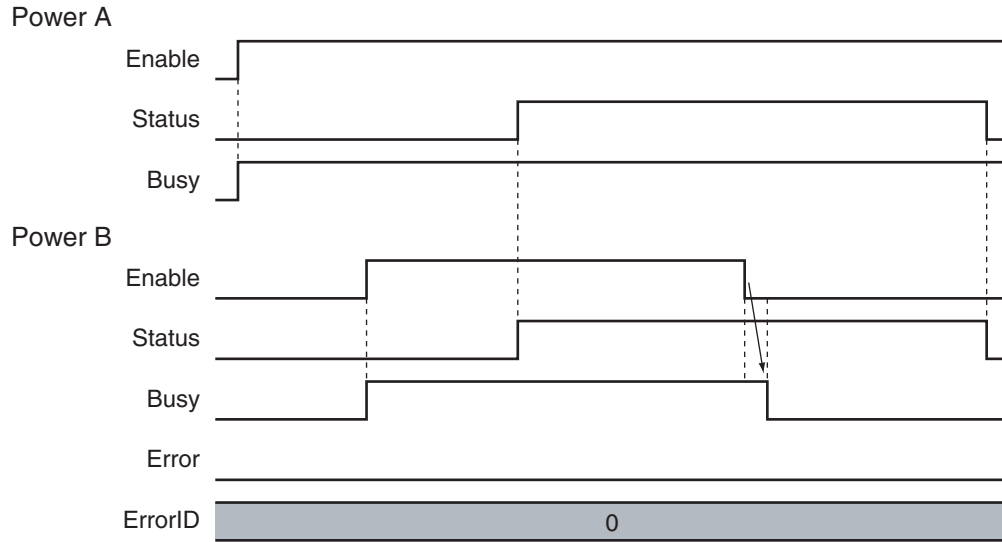

## Error Codes

Refer to the *NJ/NX-series Troubleshooting Manual (Cat. No. W503)* for instruction errors.

# MC\_MoveJog

The MC\_MoveJog instruction jogs an axis according to the specified target velocity.

Instruction	Name	FB/ FUN	Graphic expression	ST expression
MC_MoveJog	Jog	FB		<pre>MC_MoveJog_instance (   Axis :=parameter,   PositiveEnable :=parameter,   NegativeEnable :=parameter,   Velocity :=parameter,   Acceleration :=parameter,   Deceleration :=parameter,   Busy =&gt;parameter,   CommandAborted =&gt;parameter,   Error =&gt;parameter,   ErrorID =&gt;parameter );</pre>

## Variables

### Input Variables

Name	Meaning	Data type	Valid range	Default	Description
PositiveEnable	Positive Direction Enable	BOOL	TRUE or FALSE	FALSE	When this variable changes to TRUE, the axis starts moving in the positive direction. When it changes to FALSE, the axis stops moving.
NegativeEnable	Negative Direction Enable	BOOL	TRUE or FALSE	FALSE	When this variable changes to TRUE, the axis starts moving in the negative direction. When it changes to FALSE, the axis stops moving.
Velocity	Target Velocity	LREAL	Non-negative number	0	Specify the target velocity. The unit is command units/s.*1
Acceleration	Acceleration Rate	LREAL	Non-negative number	0	Specify the acceleration rate. The unit is command units/s <sup>2</sup> .*1
Deceleration	Deceleration Rate	LREAL	Non-negative number	0	Specify the deceleration rate. The unit is command units/s <sup>2</sup> .*1

\*1. Refer to *Unit Conversion Settings* in the *NJ/NX-series CPU Unit Motion Control User's Manual (Cat. No. W507)* for information on command units.

### Output Variables

Name	Meaning	Data type	Valid range	Description
Busy	Executing	BOOL	TRUE or FALSE	TRUE when the instruction is acknowledged.



Name	Meaning	Data type	Valid range	Description
CommandAborted	Command Aborted	BOOL	TRUE or FALSE	TRUE when the instruction is aborted.
Error	Error	BOOL	TRUE or FALSE	TRUE while there is an error.
ErrorID	Error Code	WORD	*1	Contains the error code when an error occurs. A value of 16#0000 indicates normal execution.

\*1. The upper four digits of the event code give the error code for ErrorID. Refer to the *NJ/NX-series Troubleshooting Manual (Cat. No. W503)* for the event codes.

### ● Output Variable Update Timing

Name	Timing for changing to TRUE	Timing for changing to FALSE
Busy	When <i>PositiveEnable</i> or <i>NegativeEnable</i> changes to TRUE.	<ul style="list-style-type: none"> <li>When the axis stops.</li> <li>When <i>Error</i> changes to TRUE.</li> <li>When <i>CommandAborted</i> changes to TRUE.</li> </ul>
CommandAborted	<ul style="list-style-type: none"> <li>When this instruction is aborted because another motion control instruction was executed with the Buffer Mode set to <b>Aborting</b>.</li> <li>When this instruction is canceled due to an error.</li> <li>When this instruction is executed while there is an error.</li> <li>When you start this instruction during MC_Stop instruction execution.</li> </ul>	<ul style="list-style-type: none"> <li>When <i>PositiveEnable</i> is TRUE and changes to FALSE.</li> <li>When <i>NegativeEnable</i> is TRUE and changes to FALSE.</li> <li>After one period when <i>PositiveEnable</i> and <i>NegativeEnable</i> are FALSE.</li> </ul>
Error	When there is an error in the execution conditions or input parameters for the instruction.	When the error is cleared.

## In-Out Variables

Name	Meaning	Data type	Valid range	Description
Axis	Axis	_sAXIS_REF	---	Specifies the axis. *1

\*1. Specify a user-defined Axis Variable that was created in the Axis Basic Settings of the Sysmac Studio (default: MC\_Axis\*) or a system-defined axis variable name (`_MC_AX[*]`, `_MC1_AX[*]`, or `_MC2_AX[*]`).  
 If you use Sysmac Studio version 1.29 or higher, you can specify the system-defined axis variable name for AT specification of a user-defined variable. This will allow you to specify the user-defined variable.  
 If you use Sysmac Studio version 1.28 or lower, do not specify any user-defined variable created in the variable table.

## Function

- The MC\_MoveJog (Jog) instruction performs jogging according to the specified *Velocity* (Target Velocity).
- To jog in the positive direction, change *PositiveEnable* (Positive Direction Enable) to TRUE. To jog in the negative direction, change *NegativeEnable* (Negative Direction Enable) to TRUE.
- If *PositiveEnable* (Positive Direction Enable) and *NegativeEnable* (Negative Direction Enable) are changed to TRUE at the same time, *PositiveEnable* (Positive Direction Enable) takes priority. As a result, the axis will jog in the positive direction.

- If the command velocity of the MC\_MoveJog (Jog) instruction exceeds the **Maximum Jog Velocity** value that is set in the axis parameters, the **Maximum Jog Velocity** value is used.



**Precautions for Correct Use**

- When creating a ladder diagram program, you must connect the *PositiveEnable* (Positive Direction Enable) input variable to the left bus bar and specify a variable for the *NegativeEnable* (Negative Direction Enable) input variable as shown below.

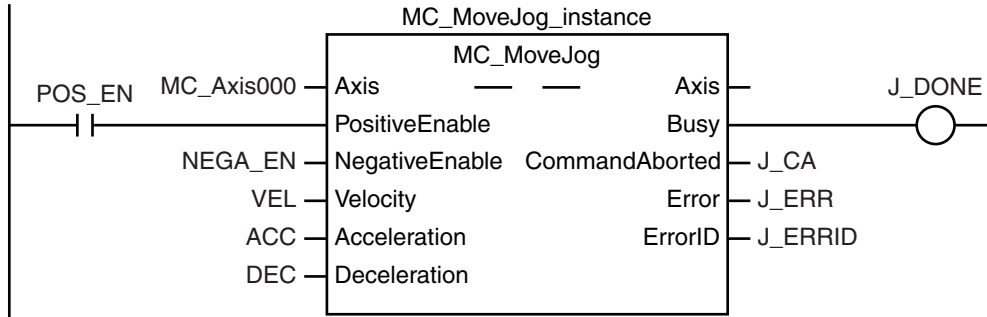

To use the master control instructions (MC and MCR) for the MC\_MoveJog (Jog) instruction, do not program the instructions as shown below. If you do, master control is applied only to *PositiveEnable* (Positive Direction Enable), i.e., it is not applied to *NegativeEnable* (Negative Direction Enable).

Master control started.

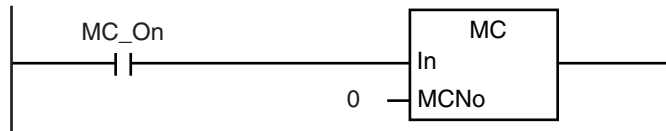

MC\_MoveJog Instruction

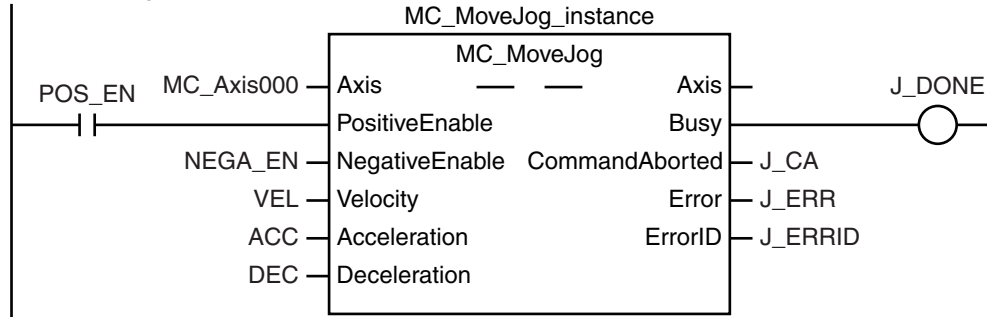

Master control ended.

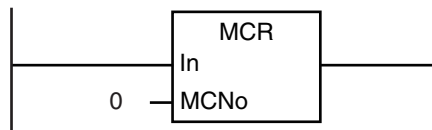

Always use the master control instructions for the MC\_Power instruction.

Master control started.

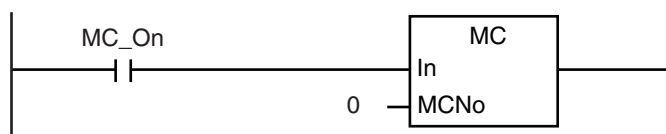

Servo turned ON.

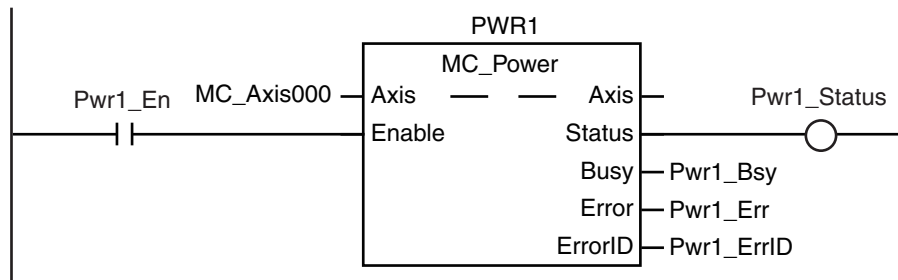

Master control ended.

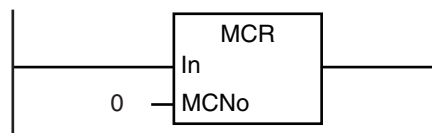

MC\_MoveJog Instruction

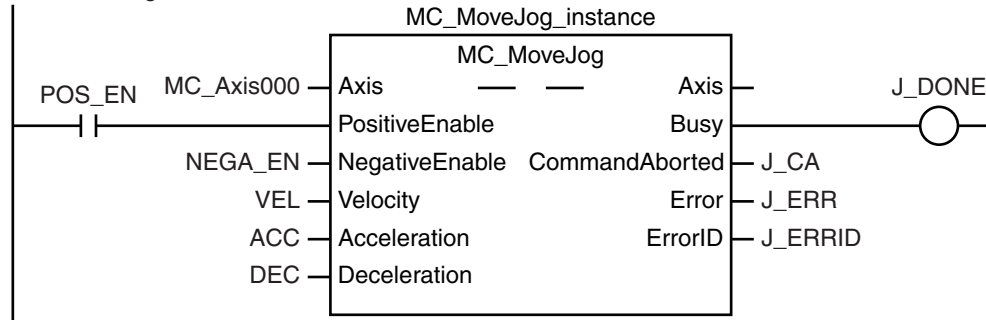

## Timing Charts

- *Busy* (Executing) changes to TRUE as soon as *PositiveEnable* (Positive Direction Enable) or *NegativeEnable* (Negative Direction Enable) changes to TRUE.
- The axis starts deceleration as soon as *PositiveEnable* (Positive Direction Enable) or *NegativeEnable* (Negative Direction Enable) changes to FALSE. *Busy* (Executing) changes to FALSE when the axis stops completely.
- If another instruction aborts this instruction, *CommandAborted* changes to TRUE and *Busy* (Executing) changes to FALSE.

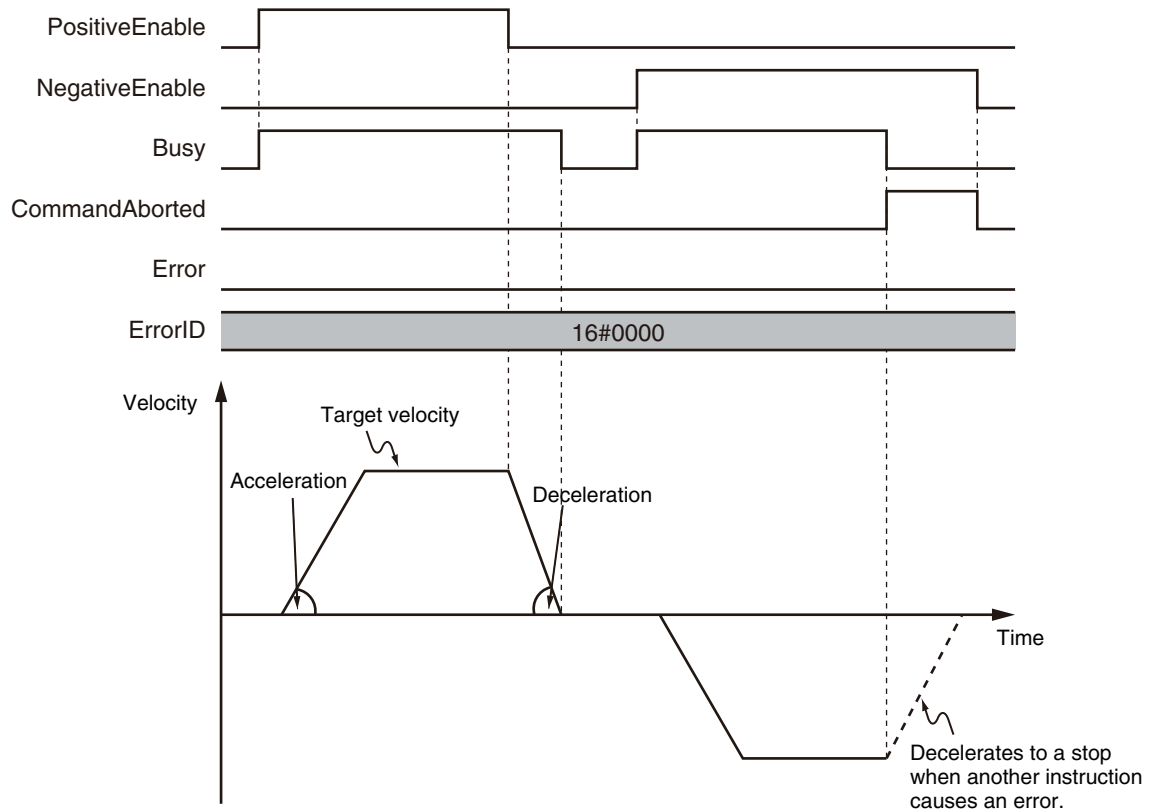

You can specify the *Velocity* (Target Velocity), *Acceleration* (Acceleration Rate), and *Deceleration* (Deceleration Rate) as input variables.

Input variables *Velocity* (Target Velocity), *Acceleration* (Acceleration Rate), and *Deceleration* (Deceleration Rate) are updated in the motion only when *PositiveEnable* (Positive Direction Enable) or *NegativeEnable* (Negative Direction Enable) changes to TRUE. Therefore, the axis velocity will not change even if *Velocity* (Target Velocity) changes while *PositiveEnable* (Positive Direction Enable) or *NegativeEnable* (Negative Direction Enable) remains TRUE.

### ● Timing Chart When Target Velocity Is 0

When the *Velocity* (Target Velocity) is 0 and you start jogging the axis, the axis will enter continuous operation without motion. The following timing chart shows an example when the *Velocity* (Target Velocity) is 0 and you start jogging the axis.

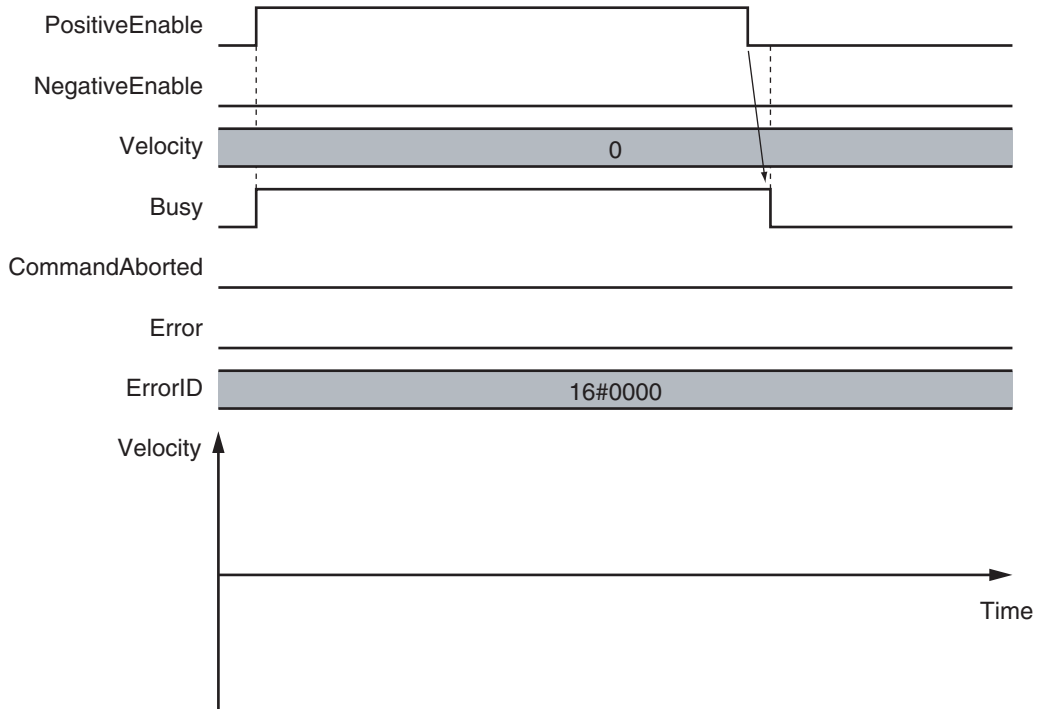

● **Timing Chart When Acceleration/Deceleration Rate Is 0**

When the *Acceleration* (Acceleration Rate) or *Deceleration* (Deceleration Rate) is 0 and you start jogging the axis, the axis will reach the target velocity without accelerating or decelerating. The timing chart below shows an example when the *Acceleration* (Acceleration Rate) and *Deceleration* (Deceleration Rate) are 0.

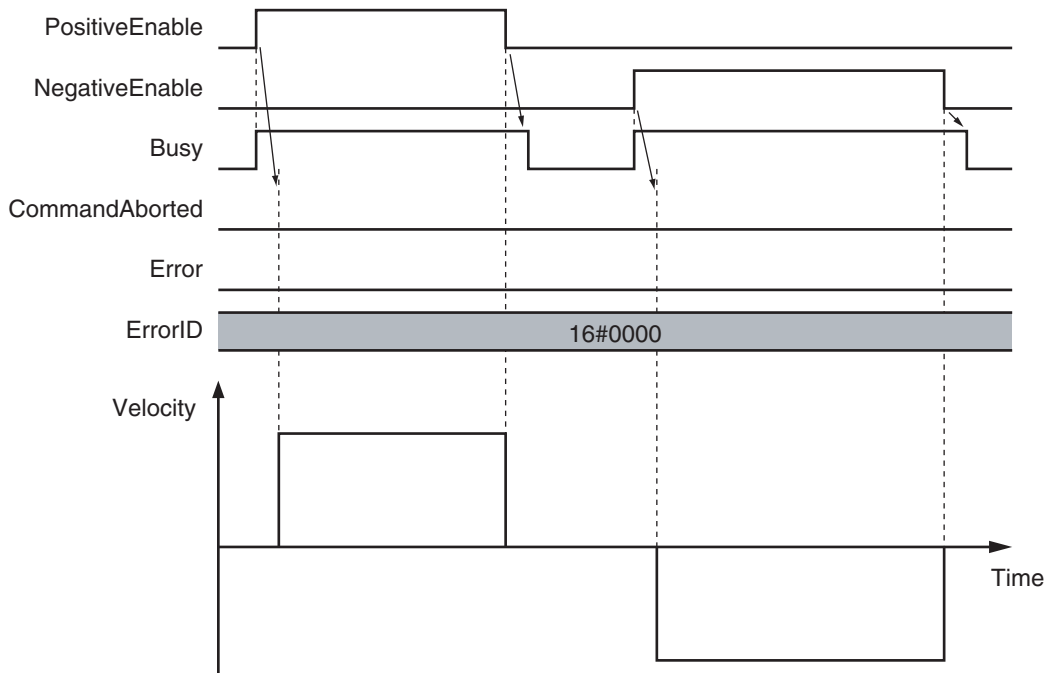

## Re-execution of Motion Control Instructions

### ● Restarting with *Enable* in the Same Direction

If you change *PositiveEnable* (Positive Direction Enable) or *NegativeEnable* (Negative Direction Enable) to TRUE when it is FALSE and the axis is decelerating, the axis will begin to accelerate towards the target velocity.

If you change the *Velocity* (Target Velocity), *Acceleration* (Acceleration Rate), or *Deceleration* (Deceleration Rate) at this time, the new value of the input parameter is used in operation.

The axis is not stopped, and *Busy* (Executing) does not change to FALSE.

The following example shows operation when *PositiveEnable* (Positive Direction Enable) changes to TRUE during deceleration.

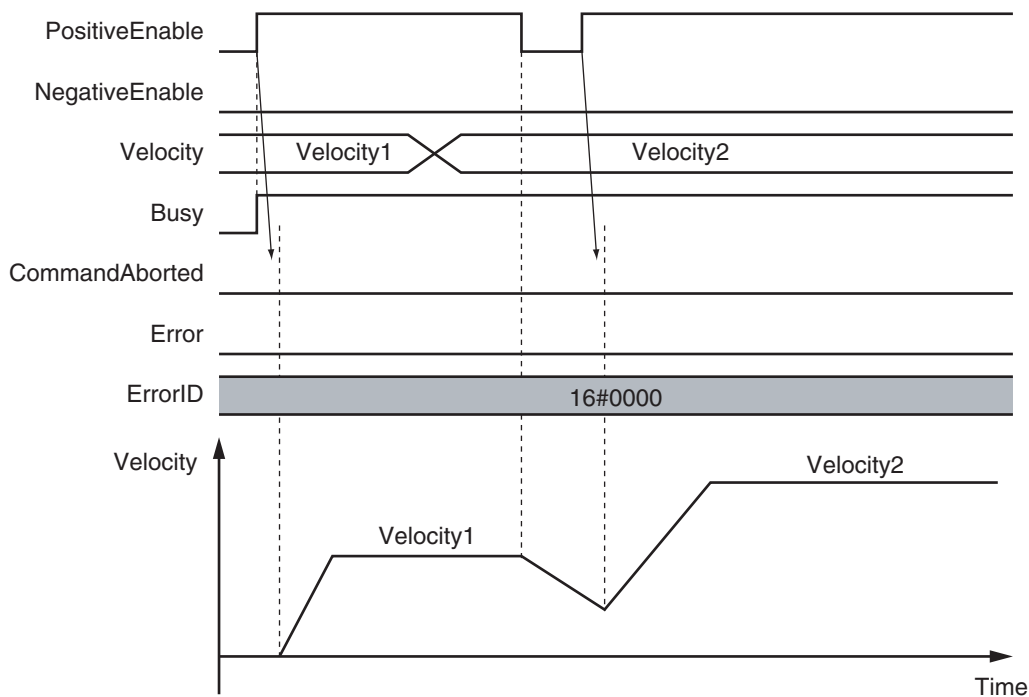

### ● Restarting with *Enable* in the Opposite Direction

If you change *NegativeEnable* (Negative Direction Enable) to TRUE when *PositiveEnable* (Positive Direction Enable) is TRUE and the axis is jogging in the positive direction, the axis will reverse its direction and start jogging in the negative direction.

When this happens, you can jog the axis with the input variables for when *NegativeEnable* (Negative Direction Enable) changes to TRUE. The input variables are *Velocity* (Target Velocity), *Acceleration* (Acceleration Rate), and *Deceleration* (Deceleration Rate).

The deceleration rate when the axis direction is reversed and the acceleration rate after it is reversed follow the input variables for when *NegativeEnable* (Negative Direction Enable) changes to TRUE, regardless of the **Operation Selection at Reversing** axis parameter.

When *NegativeEnable* (Negative Direction Enable) is TRUE and the axis is jogging in the negative direction, the same operation occurs when *PositiveEnable* (Positive Direction Enable) changes to TRUE.

If *NegativeEnable* (Negative Direction Enable) changes to TRUE while *PositiveEnable* (Positive Direction Enable) is TRUE, the axis starts jogging in the negative direction. In this case, the axis will not jog in the positive direction even if *NegativeEnable* (Negative Direction Enable) changes to FALSE.

To jog the axis in the positive direction, change *PositiveEnable* (Positive Direction Enable) to FALSE, and then back to TRUE again.

The same operation applies to the opposite case.

The following example shows an operation example when *NegativeEnable* (Negative Direction Enable) changes to TRUE after *PositiveEnable* (Positive Direction Enable) changes to TRUE.

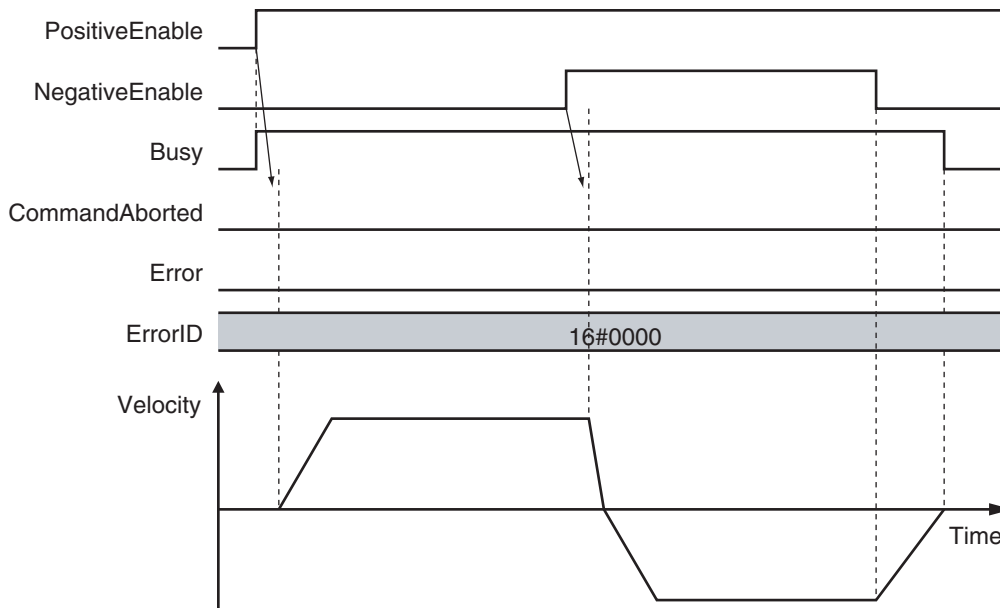

## Multi-execution of Motion Control Instructions

For details on multi-execution of motion control instructions, refer to the *NJ/NX-series CPU Unit Motion Control User's Manual (Cat. No. W507)*.

## Errors

If an error occurs during instruction execution, *Error* will change to TRUE.

You can find out the cause of the error by referring to the value output by *ErrorID* (Error Code).



● **Timing Chart When Error Occurs**

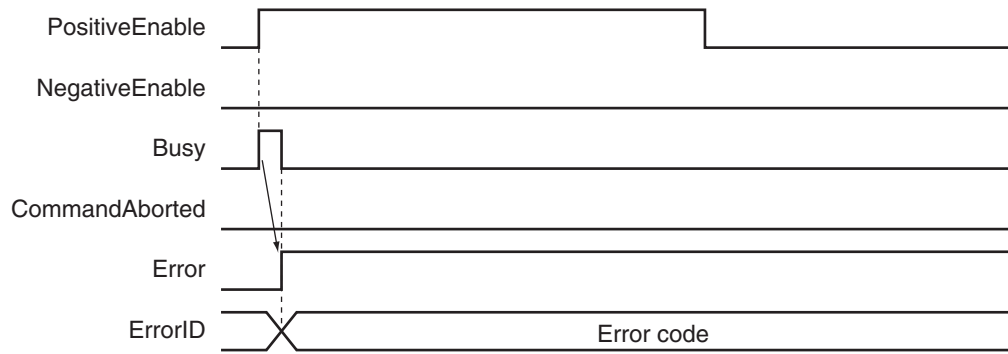

● **Error Codes**

Refer to the *NJ/NX-series Troubleshooting Manual (Cat. No. W503)* for instruction errors.

# MC\_Home

The MC\_Home instruction operates the motor to determine home. It uses the limit signals, home proximity signal, and home signal.

Instruction	Name	FB/ FUN	Graphic expression	ST expression
MC_Home	Home	FB		<pre>MC_Home_instance (   Axis :=parameter,   Execute :=parameter,   Done =&gt;parameter,   Busy =&gt;parameter,   CommandAborted =&gt;parameter,   Error =&gt;parameter,   ErrorID =&gt;parameter );</pre>

## Variables

### Input Variables

Name	Meaning	Data type	Valid range	Default	Description
Execute	Execute	BOOL	TRUE or FALSE	FALSE	The instruction is executed when the value of this variable changes to TRUE.

### Output Variables

Name	Meaning	Data type	Valid range	Description
Done	Done	BOOL	TRUE or FALSE	TRUE when the instruction is completed.
Busy	Executing	BOOL	TRUE or FALSE	TRUE when the instruction is acknowledged.
CommandAborted	Command Aborted	BOOL	TRUE or FALSE	TRUE when the instruction is aborted.
Error	Error	BOOL	TRUE or FALSE	TRUE while there is an error.
ErrorID	Error Code	WORD	*1	Contains the error code when an error occurs. A value of 16#0000 indicates normal execution.

\*1. The upper four digits of the event code give the error code for ErrorID. Refer to the *NJ/NX-series Troubleshooting Manual (Cat. No. W503)* for the event codes.

### ● Output Variable Update Timing

Name	Timing for changing to TRUE	Timing for changing to FALSE
Done	When the instruction is completed.	<ul style="list-style-type: none"> <li>When <i>Execute</i> is TRUE and changes to FALSE.</li> <li>After one period when <i>Execute</i> is FALSE.</li> </ul>

Name	Timing for changing to TRUE	Timing for changing to FALSE
Busy	When <i>Execute</i> changes to TRUE.	<ul style="list-style-type: none"> <li>When <i>Done</i> changes to TRUE.</li> <li>When <i>Error</i> changes to TRUE.</li> <li>When <i>CommandAborted</i> changes to TRUE.</li> </ul>
CommandAborted	<ul style="list-style-type: none"> <li>When this instruction is aborted because another motion control instruction was executed with the Buffer Mode set to <b>Aborting</b>.</li> <li>When this instruction is canceled due to an error.</li> <li>When this instruction is executed while there is an error.</li> <li>When you start this instruction during MC_Stop instruction execution.</li> </ul>	<ul style="list-style-type: none"> <li>When <i>Execute</i> is TRUE and changes to FALSE.</li> <li>After one period when <i>Execute</i> is FALSE.</li> </ul>
Error	When there is an error in the execution conditions or input parameters for the instruction.	When the error is cleared.

## In-Out Variables

Name	Meaning	Data type	Valid range	Description
Axis	Axis	_sAXIS_REF	---	Specifies the axis. *1

\*1. Specify a user-defined Axis Variable that was created in the Axis Basic Settings of the Sysmac Studio (default: MC\_Axis\*) or a system-defined axis variable name (\_MC\_AX[\*], \_MC1\_AX[\*], or \_MC2\_AX[\*]).

If you use Sysmac Studio version 1.29 or higher, you can specify the system-defined axis variable name for AT specification of a user-defined variable. This will allow you to specify the user-defined variable.

If you use Sysmac Studio version 1.28 or lower, do not specify any user-defined variable created in the variable table.

## Function

- Homing starts when *Execute* changes to TRUE for the axis specified in *Axis*.
- Set the parameters used by the MC\_Home instruction in the axis parameters.
- There are 10 Homing Operation Modes for the MC\_Home instruction.  
Set the desired method in axis parameter **Homing Method** in the Sysmac Studio.



### Precautions for Correct Use

Refer to 1-1-3 *Precautions for Master and Auxiliary Axes in Synchronized Control* on page 1-6 for precautions on the master axis.

## ● Mapping Data Objects

To use the MC\_Home instruction, map the following object data in the **Detailed Settings** Area of the Axis Basic Settings Display of the Sysmac Studio.

However, setting is not required for Homing Operation Modes 11, 12, and 14.

- Touch probe function (60B8 hex)
- Touch probe status (60B9 hex)
- Touch probe pos1 pos value (60BA hex)

If even one of the required objects is not set, a Process Data Object Setting Missing error (error code 3461 hex) occurs.

For details on mapping data objects, refer to *2-3 PDO Mapping* on page 2-39 and to the *NJ/NX-series CPU Unit Motion Control User's Manual (Cat. No. W507)*.

Refer to *I/O Entry Mappings* in the *NX-series Position Interface Units User's Manual (Cat. No. W524)* for information on using the NX-series Position Interface Units.

### Settings for OMRON 1S-series Servo Drives

---

Set the input signals, such as the home proximity signal, that are used by the MC\_Home instruction in the OMRON 1S-series Servo Drive.

For details on how to set the input signals, refer to *Connecting the Servo Drive* in the *NJ/NX-series CPU Unit Motion Control User's Manual (Cat. No. W507)*, and to *General-purpose Input Signals* in the *AC Servomotors/Servo Drives 1S-series with Built-in EtherCAT Communications User's Manual (Cat. No. I586)* or *AC Servomotors/Servo Drives 1S-series with Built-in EtherCAT Communications and Safety Functionality User's Manual (Cat. No. I621)*.

### Settings for OMRON G5-series Servo Drives

---

Set the input signals, such as the home proximity signal, that are used by the MC\_Home instruction in the OMRON G5-series Servo Drive.

For details on how to set the input signals, refer to *Connecting to the Servo Drive* in the *NJ/NX-series CPU Unit Motion Control User's Manual (Cat. No. W507)*, and *Sequence I/O Signals* in the *AC Servomotors/Servo Drives G5-series with Built-in EtherCAT Communications User's Manual (Cat. No. I576)* or the *AC Servomotors/Servo Drives G5-series with Built-in EtherCAT Communications Linear Motor Type User's Manual (Cat. No. I577)*.

### Settings for NX-series Position Interface Units

---

Refer to the *NX-series Position Interface Units User's Manual (Cat. No. W524)* for information on setting the NX-series Position Interface Units.

### Homing Operation Modes

---

You can select any of the ten operations to define home.

- Proximity reverse turn/home proximity input OFF
- Proximity reverse turn/home proximity input ON
- Home proximity input OFF
- Home proximity input ON
- Limit input OFF
- Proximity reverse turn/home input mask distance
- Limit inputs only
- Proximity reverse turn/holding time
- No home proximity input/holding home input
- Zero position preset

The following tables shows the homing parameters that are used for each Homing Operation Mode.

(O: Parameter is used, ---: Parameter is not used.)

	Homing parameters															
	Home Input Signal	Homing Start Direction	Home Input Detection Direction	Operation Selection at Positive Limit Input	Operation Selection at Negative Limit Input	Homing Velocity	Homing Approach Velocity	Homing Acceleration	Homing Deceleration	Homing Jerk	Home Input Mask Distance	Home Offset	Homing Holding Time	Homing Compensation Value	Homing Compensation Velocity	
<b>Homing Operation Mode</b>																
Proximity reverse turn/home proximity input OFF	O	O	O	O	O	O	O	O	O	O	---	O	---	O	O	O
Proximity reverse turn/home proximity input ON	O	O	O	O	O	O	O	O	O	O	---	O	---	O	O	O
Home proximity input OFF	O	O	O	O	O	O	O	O	O	O	---	O	---	O	O	O
Home proximity input ON	O	O	O	O	O	O	O	O	O	O	---	O	---	O	O	O
Limit input OFF	O	O	O	O	O	O	O	O	O	O	---	O	---	O	O	O
Proximity reverse turn/home input mask distance	O	O	O	O	O	O	O	O	O	O	O	O	---	O	O	O
Limit inputs only	---	O	O	O	O	O	O	O	O	O	---	O	---	O	O	O
Proximity reverse turn/holding time	---	O	O	O	O	O	O	O	O	O	---	O	O	O	O	O
No home proximity input/holding home input	O	O	O	O	O	O	O	O	O	O	---	O	---	O	O	O
Zero position preset	---	---	---	---	---	---	---	---	---	---	---	O	---	---	---	---

Refer to *Homing Definition Operation* on page 3-24 for details on operation in the Homing Modes.



**Additional Information**

If you use NX-series Position Interface Units, do not select holding for the Homing Operation Mode. Refer to the *NX-series Position Interface Units User's Manual (Cat. No. W524)* for details.

## Operation Selection at Positive Limit Input and Operation Selection at Negative Limit Input

- Select the operation when the axis reaches a limit input in the operating direction during homing: reverse the axis and continue with homing, or do not reverse the axis, create an error, and stop the axis. To reverse the axis, also select the stopping method.
- An error occurs and the axis stops if the axis is set to **Reverse turn**, and the limit signal in the home input detection direction turns ON when traveling at the homing approach velocity. However, if the homing operation mode is **13: No Home Proximity Input/Holding Home Input**, which does not use proximity signals, no error will occur and the axis will not stop.

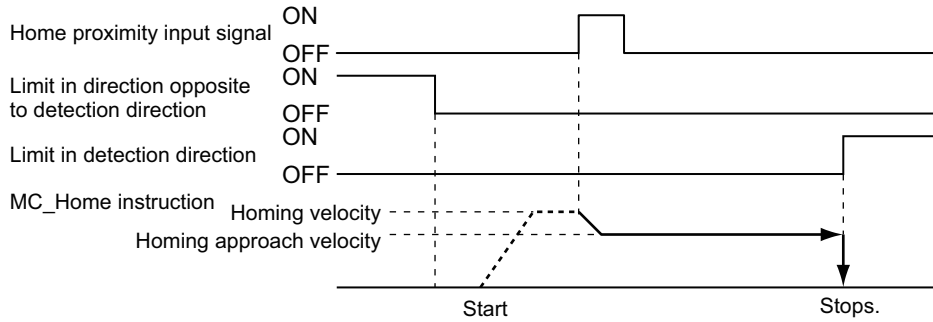

- An error occurs and the axis stops if the axis is set to **Reverse turn** for the limit input operation in both directions and home cannot be detected after moving from the limit input opposite to the home input detection direction to the other limit input.

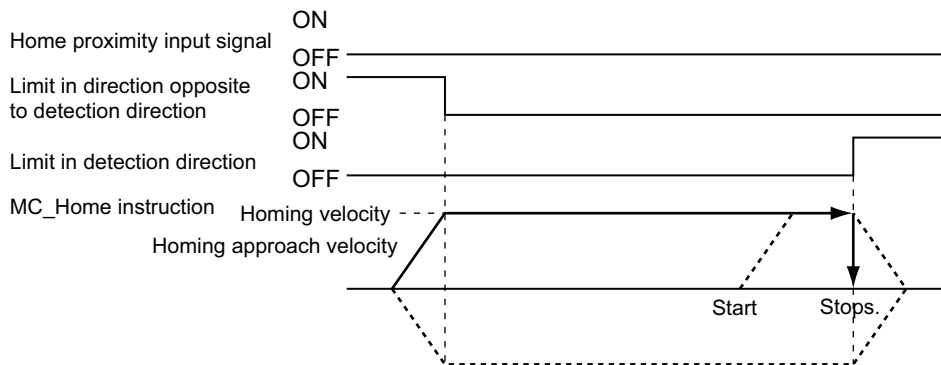

## Homing Start Direction

Select the direction in which the axis starts moving when homing is started.

If homing starts while the home proximity signal is ON in a Homing Operation Mode that includes reversal operation, the axis starts motion in the direction opposite to the home input detection direction (regardless of the setting of the homing start direction).

There are four Homing Operation Modes that include reversal operation for a reverse turn. These are listed below.

- 0: Proximity Reverse Turn/Home Proximity Input OFF
- 1: Proximity Reverse Turn/Home Proximity Input ON
- 9: Proximity Reverse Turn/Home Input Mask Distance
- 12: Proximity Reverse Turn/Holding Time

Homing start direction: Positive  
Home input detection direction: Positive

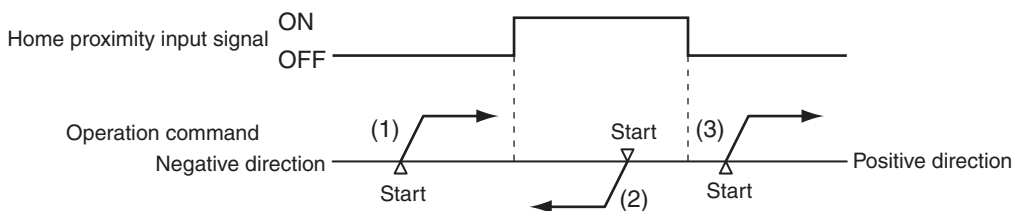

(1), (3) : The home proximity signal is OFF, so the axis starts moving in the homing start direction.

- (2) : The home proximity signal is ON, so the axis starts moving in the direction opposite to the home input detection direction.

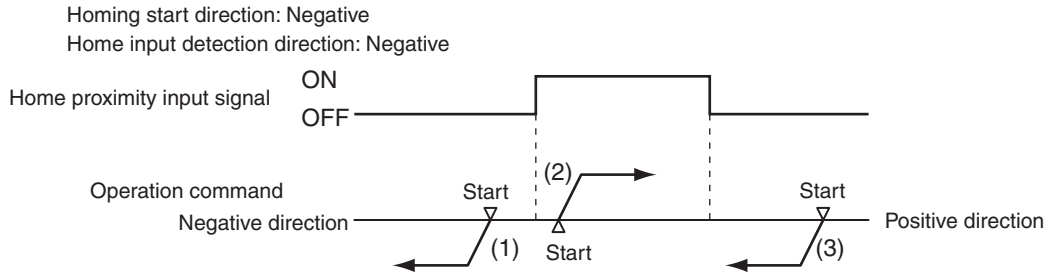

- (1), (3) : The home proximity signal is OFF, so the axis starts moving in the homing start direction.
- (2) : The home proximity signal is ON, so the axis starts moving in the direction opposite to the home input detection direction.

## Home Input Detection Direction

Select the direction when home input is detected.

The following timing chart shows the operation when the home input detection direction is FALSE (positive direction).

Operation Example: Proximity Reverse Turn/Home Proximity Input OFF

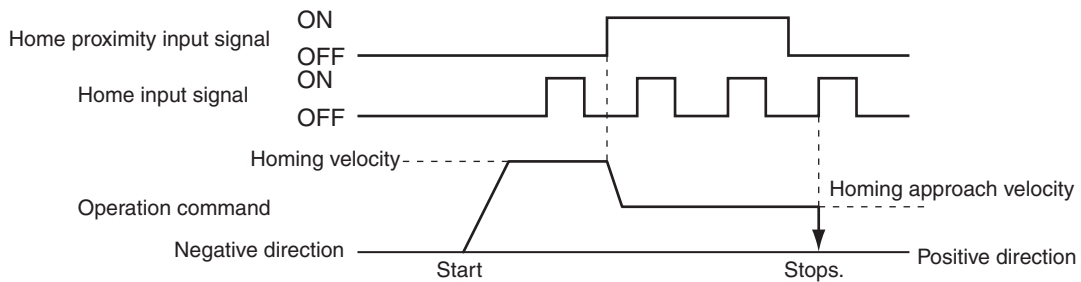

The following timing chart shows the operation when the home input detection direction is TRUE (negative direction).

Operation Example: Proximity Reverse Turn/Home Proximity Input OFF

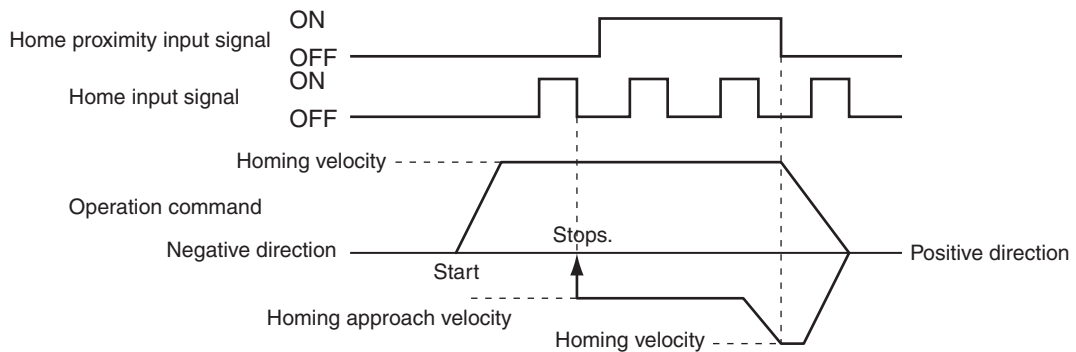

## Home Input Mask Distance

---

Set the feed distance when you set the Homing Operation Mode to **9: Proximity Reverse Turn/Home Input Mask Distance**.

For details on the operation, refer to *9: Proximity Reverse Turn/Home Input Mask Distance Operation* on page 3-28.

## Homing Compensation Value

---

Set the homing compensation value that is applied after the home is detected.

Set the travel velocity in the **Homing Compensation Velocity** parameter.

For details on the operation, refer to *Homing Compensation* on page 3-35.

## Home Position Offset

---

The Home Position Offset is used to preset the actual position after homing is completed.

The current position is specified with the value set for **Home Position Offset**.

## Homing Velocity

---

This is the high velocity during homing.

## Homing Approach Velocity

---

This is the proximity velocity during homing.

## Homing Compensation Velocity

---

This is the travel velocity when you set a the **Homing Compensation Value** parameter.

For details on the operation, refer to *Homing Compensation* on page 3-35.

## Homing Definition Operation

---

This section describes the 10 Homing Operation Modes.

### ● 0: Proximity Reverse Turn/Home Proximity Input OFF Operation

- 1** The axis starts at the homing velocity. When the home proximity input signal turns ON, the axis starts decelerating to the homing approach velocity.
- 2** After the axis reaches the homing approach velocity, the axis stops at the first home input signal after the home proximity input signal turns OFF. This defines home.



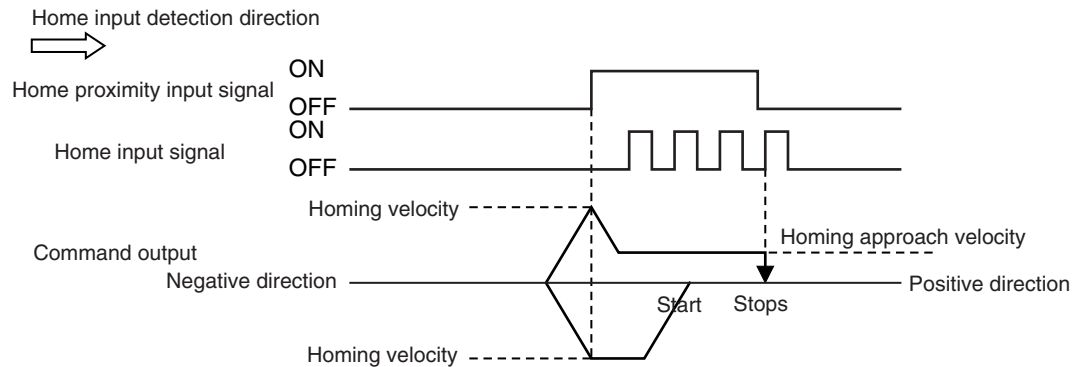

- If you start homing while the home proximity input signal is ON, the operation will start at the homing velocity in the direction opposite to the home input detection direction. After the home proximity input turns OFF, the homing operation will start at the homing velocity in the home input detection direction.
- Homing is started and home is defined when the home input signal turns ON after the home proximity input signal turns ON and OFF while the velocity is below the homing approach velocity.

### ● 1: Proximity Reverse Turn/Home Proximity Input ON Operation

- 1** The axis starts at the homing velocity. When the home proximity input signal turns ON, the axis starts decelerating to the homing approach velocity.
- 2** After the axis reaches the homing approach velocity, the axis stops at the first home input signal. This defines home. After the home proximity input signal turns ON, its status does not affect operation.

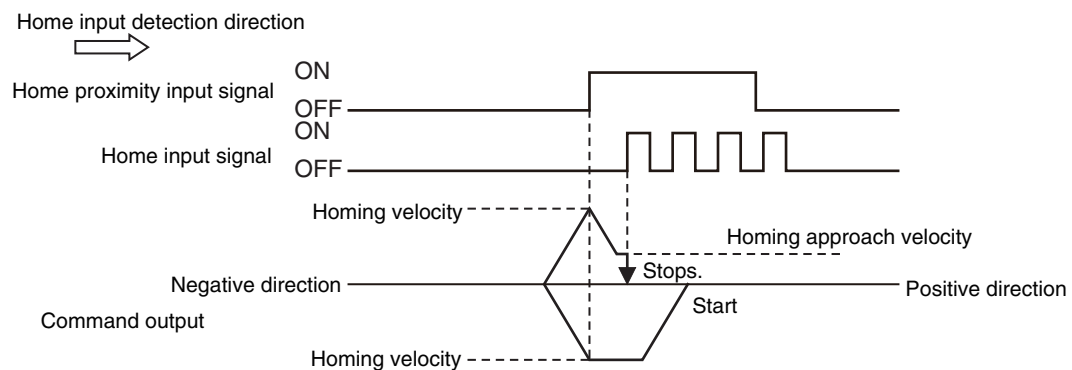

- If you start homing while the home proximity input signal is ON, the operation will start at the homing velocity in the direction opposite to the home input detection direction. After the home proximity input turns OFF, the homing operation will start at the homing velocity in the home input detection direction.
- Homing is started and home is defined when the home input signal turns ON after the home proximity input signal turns ON while the velocity is below the homing approach velocity.

### ● 4: Operation for Home Proximity Input OFF

- 1 When the home proximity input signal turns ON, the axis starts decelerating to the homing approach velocity.
- 2 After the axis reaches the homing approach velocity, the axis stops at the first home input signal after the home proximity input signal turns OFF. This defines home.

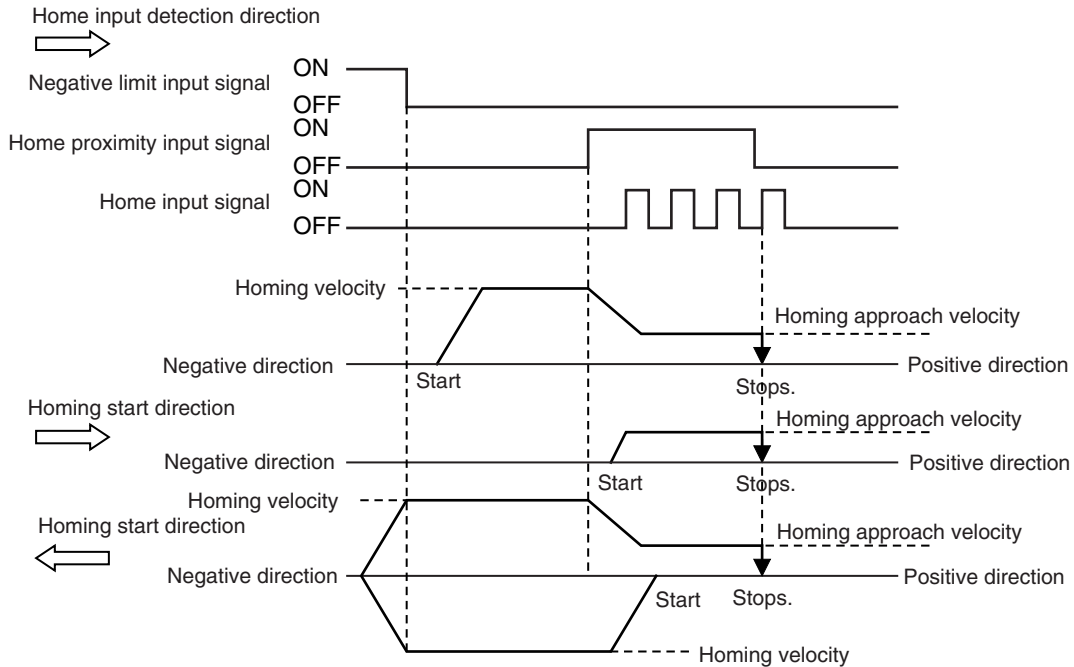

- If you start homing while the home proximity input signal is ON, the axis performs the following operation depending on the setting of the homing start direction.

#### Homing Start Direction Same as Home Input Detection Direction

The axis does not perform a reverse turn operation and homing starts in the home input detection direction at the homing approach velocity.

#### Homing Start Direction Different from Home Input Detection Direction

Operation starts in the homing start direction at the homing velocity, regardless of the status of the home proximity input signal. If you set the operation at the limit input in the homing start direction to **Reverse turn**, the axis reverses direction when limit input is detected, and performs a homing operation in the home input detection direction.

- Homing is started and home is defined when the home input signal turns ON after the home proximity input signal turns ON and OFF while the velocity is below the homing approach velocity.

### ● 5: Home Proximity Input ON Operation

- 1 When the home proximity input signal turns ON, the axis starts decelerating to the homing approach velocity.
- 2 After the axis reaches the homing approach velocity, the axis stops at the first home input signal. This defines home. After the home proximity input signal turns ON, its status does not affect operation.

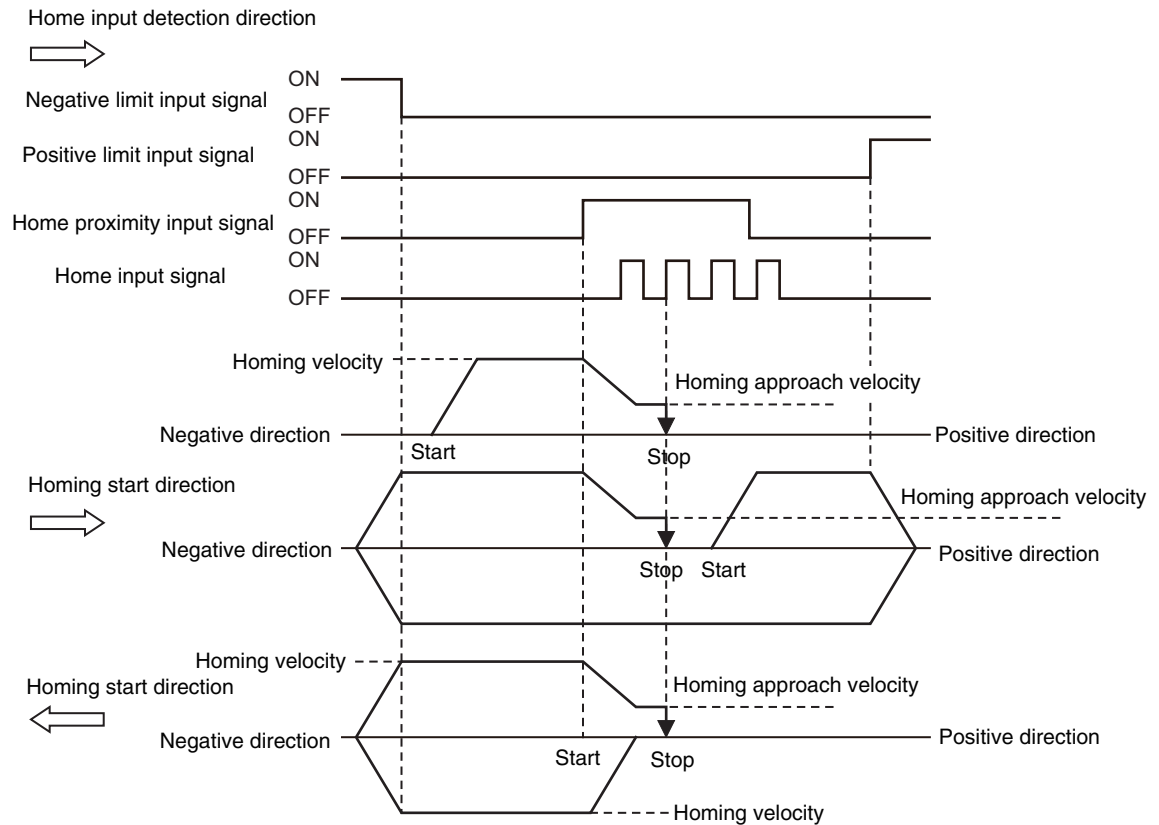

- If you start homing while the home proximity input signal is ON, the axis performs the following operation depending on the setting of the homing start direction.

#### Homing Start Direction Same as Home Input Detection Direction

The axis does not perform a reverse turn operation and homing starts in the home input detection direction at the homing velocity.

#### Homing Start Direction Different from Home Input Detection Direction

Operation starts in the homing start direction at the homing velocity, regardless of the status of the home proximity input signal. If you set the operation at the limit input in the homing start direction to **Reverse turn**, the axis reverses direction when limit input is detected, and performs a homing operation in the home input detection direction.

- Homing is started and home is defined when the home input signal turns ON after the home proximity input signal turns ON while the velocity is below the homing approach velocity.

### ● 8: Operation for Limit input OFF

- 1** The axis starts at the homing velocity. When the limit signal in the direction opposite to the home input detection direction turns ON, the axis starts decelerating to the homing approach velocity.
- 2** After the axis reaches the homing approach velocity, the axis stops at the first home input signal after the limit signal turns OFF. This defines home.

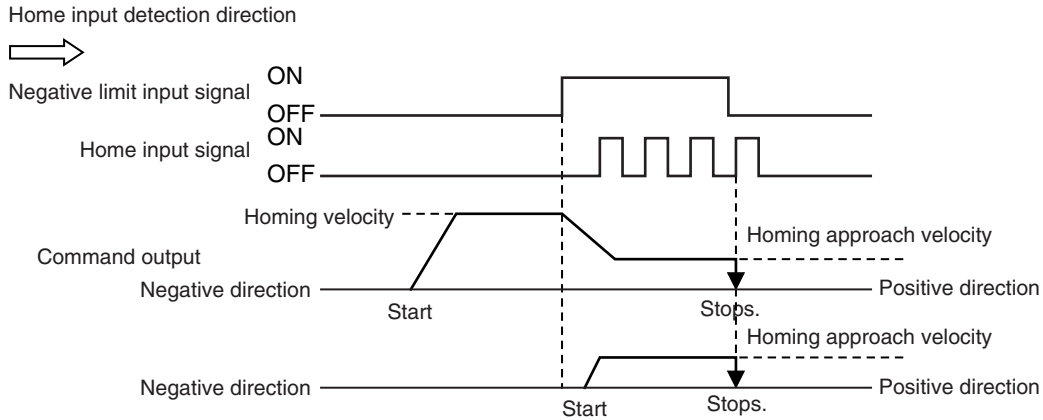

- If you perform homing while the limit input on the opposite side of the home input detection direction is ON, the homing operation starts at the home approach velocity in the home input detection direction.
- Homing is started and home is defined when the home input signal turns ON after the limit signal in the direction opposite to the home input detection direction turns ON and OFF again while the velocity is below the homing approach velocity.

#### ● 9: Proximity Reverse Turn/Home Input Mask Distance Operation

- 1** The axis starts at the homing velocity. When the home proximity input signal turns ON, the axis starts decelerating to the homing approach velocity.
- 2** The axis moves by the home input mask distance after the home proximity input signal turns ON and stops at the first home input signal. This defines home. After the home proximity input signal turns ON, its status does not affect operation. If the specified travel distance is too short and travel would be completed before the axis decelerates to the homing approach velocity, an Invalid Home Input Mask Distance error (error code: 742B hex) occurs when you start homing.

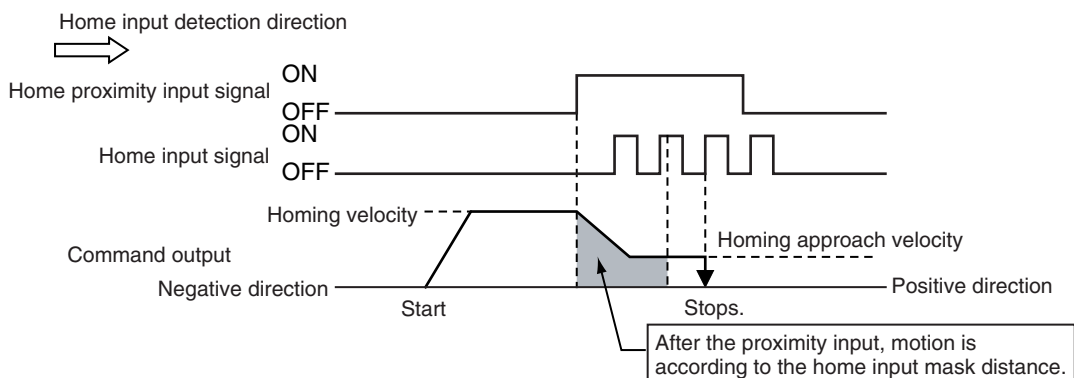

- If you start homing while the home proximity input signal is ON, the operation will start at the homing velocity in the direction opposite to the home input detection direction. After the home proximity input signal turns OFF, the homing operation will start at the homing approach velocity in the home input detection direction.

- Homing is started and home is defined when the home input signal turns ON after the axis travels the home input mask distance after the home proximity input signal turns ON while the velocity is below the homing approach velocity.

## ● 11: Operation for Limit Inputs Only

- 1** The axis starts at the homing velocity. When the limit signal in the direction opposite to the home input detection direction turns OFF, the axis decelerates to a stop.
- 2** After the axis stops, the axis moves in the other direction at the homing velocity and decelerates to a stop when the limit signal turns ON.
- 3** After the axis stops, the axis moves in the other direction at the homing approach velocity. The position where the limit signal turns OFF is defined as home and an immediate stop is performed (i.e., a stop using remaining pulses). The axis does not return to the home position.

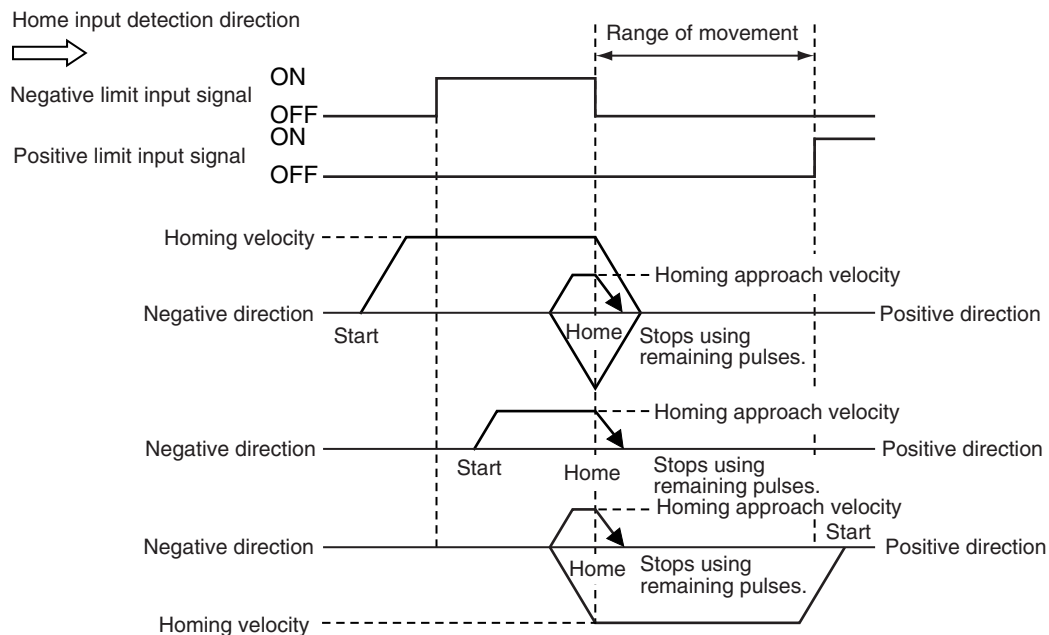

- If you use only the limit signals to perform homing, the point at which the limit signal turns OFF during operation in the home input detection direction is set as the home detection position.
- If you start homing while the limit signal in the home input detection direction is ON, the operation will start at the homing velocity in the direction opposite to the home input detection direction. When the limit signal in the direction opposite to the home input detection direction turns ON, the axis decelerates to a stop.
- Even if the limit signal turns OFF before the axis decelerates to a stop after the limit signal is detected, home is not defined and the axis continues to decelerate. In this case, no error will occur.
- Home is defined if the limit signal turns OFF before the homing approach velocity is reached after the axis reverses or after starting while the limit signal is input.

### Differences between Homing Operation Mode 11 and Other Homing Operation Modes

For Homing Operation Mode 11, the MC Function Module detects when the limit signal turns OFF to define home. It differs from a Homing Operation Mode that uses the home input as an external latch signal in the following ways.

Make sure that you understand these differences with other Homing Operation Modes before you use Homing Operation Mode 11.

- The MC Function Module detects the limit input without an external latch function, such as one provided by a Servo Drive. MC Function Module processing is the processing performed at the primary period interval for the primary periodic task and at the task period of the priority-5 periodic task for the priority-5 periodic task. Therefore, the precision of the home definition will depend on the homing approach velocity and the control period of the primary periodic task or priority-5 periodic task.
- The axis does not return to the home position. If the homing compensation value is 0, processing for homing will end with the axis at a different position (i.e., not at home).
- Homing compensation is not performed if the homing compensation value is set to 0. If the homing compensation value is 0, processing for homing ends with the axis at a different position (i.e., not at home), as explained above. If the homing compensation value is not 0, then homing compensation is performed with the homing compensation value as a relative position from home in the same way as for other homing operation modes.
- The home offset is used to change the position of home. If the stop position is offset from home by distance  $D$ , as shown in the following figure, the position after the completion of processing for homing will be  $L + D$  if the home offset is  $L$  and the homing compensation value is 0.

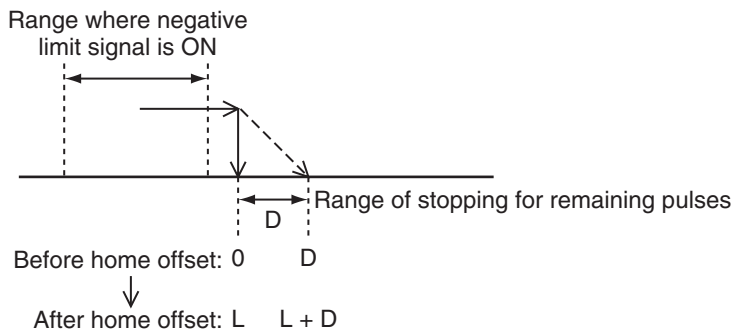

#### Precautions for Correct Use

- After the OFF limit signal is detected, the limit signal in the opposite direction from the home input detection direction is ignored while stopping for the remaining pulses until homing compensation is started.
- If the homing compensation value is 0 and the limit input signal in the home input detection direction turns ON immediately after home is defined, set a homing compensation value to return past the limit signal input position.

#### Application Example for Homing Operation Mode 11

If, as shown below, there is not sufficient space to install both a negative limit signal and home signal, you can use the negative limit signal to perform the functions of both the limit signal and home signal.

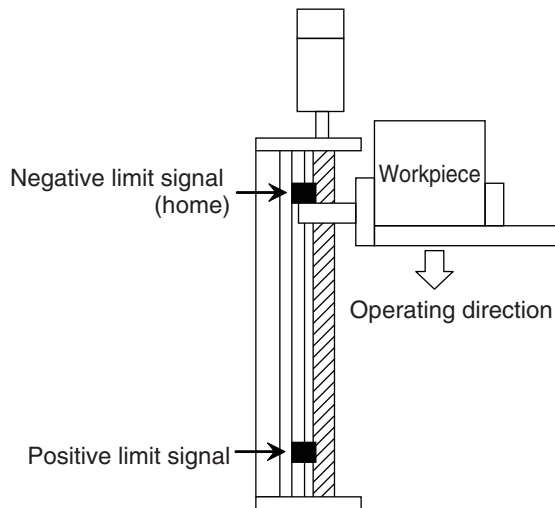

## ● 12: Proximity Reverse Turn/Holding Time Operation

- 1** The axis starts at the homing velocity. When the home proximity input signal turns ON, the axis starts decelerating to the homing approach velocity. Decelerating the axis and monitoring time are started at the same time. The torque limit at the start of holding differs between OMRON 1S-series as well as G5-series Servo Drives and other Servo Drives as shown below.

Servo Drive	Operation
1S-series, G5-series	Automatically applies torque limits.
Other Servo Drives	Apply torque limits according to a setting.

Refer to *Holding Operation for OMRON 1S-series Servo Drives* on page 3-36 or *Holding Operation for OMRON G5-series Servo Drives* on page 3-37 for information on the holding operation.

- 2** Home is defined when the set time elapses. After the home proximity input signal turns ON, its status does not affect operation.

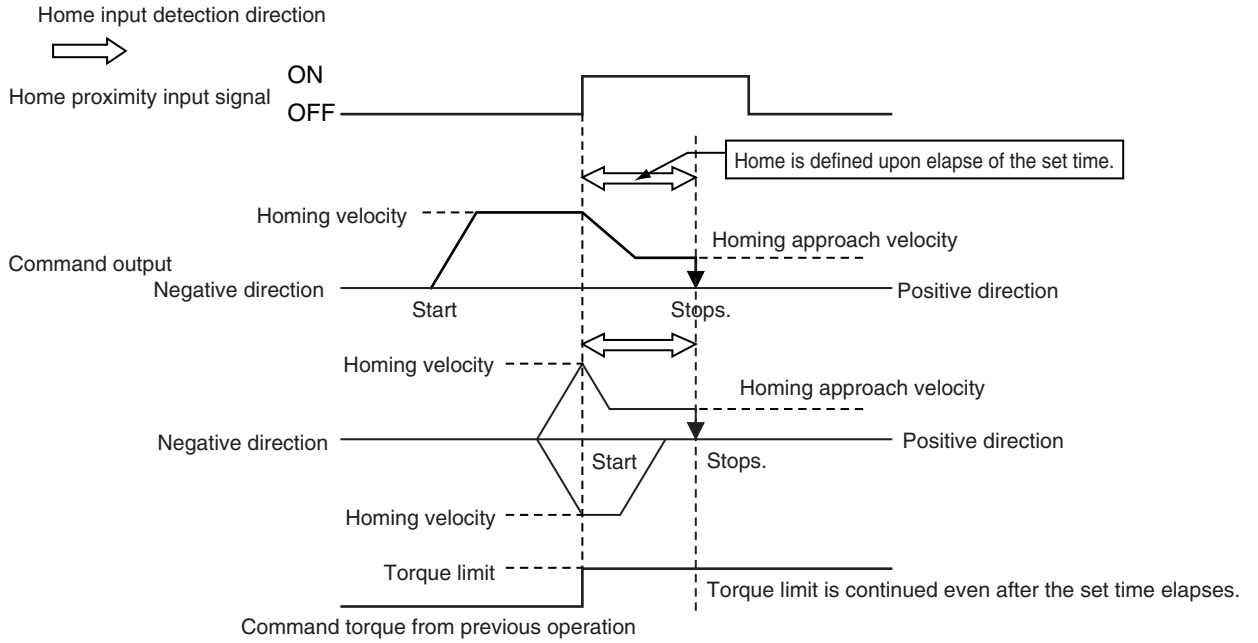

- If you start homing while the home proximity input signal is ON, the operation will start at the homing velocity in the direction opposite to the home input detection direction. After the home proximity input signal turns OFF, the homing operation will start at the homing approach velocity in the home input detection direction.
- Releasing the torque limit also differs between OMRON 1S-series as well as G5-series Servo Drives and other Servo Drives.

Servo Drive	Operation
1S-series, G5-series	Automatically released when the axis moves in the direction opposite to homing for the first time after homing.
Other Servo Drives	If a torque limit is used, release the torque limit when the axis moves in the direction opposite to homing for the first time after homing. Use the EC_CoESDOWrite (CoE SDO Write) instruction to change the torque limit.

- An error will not occur and home is defined even if the holding time elapses after the home proximity input signal is detected and before velocity reaches the homing approach velocity.
- Home is also defined if the holding time elapses after the home proximity input signal turns ON before the homing approach velocity is reached.

### ● 13: No Home Proximity Input/Holding Home Input Operation

**1** The axis starts at the homing approach velocity.

The torque limit at the start of holding differs between OMRON 1S-series as well as G5-series Servo Drives and other Servo Drives as shown below.

Servo Drive	Operation
1S-series, G5-series	Automatically applies torque limits.
Other Servo Drives	A torque limit imposed as required.

Refer to *Holding Operation for OMRON 1S-series Servo Drives* on page 3-36 or *Holding Operation for OMRON G5-series Servo Drives* on page 3-37 for information on the holding operation.



**2** Home is defined when the home input turns ON.

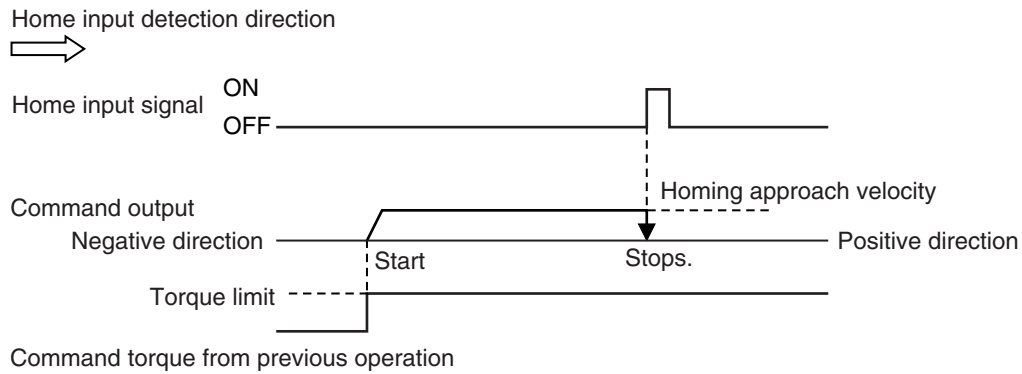

- Releasing the torque limit also differs between OMRON 1S-series as well as G5-series Servo Drives and other Servo Drives.

Servo Drive	Operation
1S-series, G5-series	Automatically released when the axis moves in the direction opposite to homing for the first time after homing.
Other Servo Drives	If a torque limit is used, release the torque limit when the axis moves in the direction opposite to homing for the first time after homing. Use the EC_CoESDOWrite (CoE SDO Write) instruction to change the torque limit.

- Home is also defined if the home input signal turns ON before the homing approach velocity is reached after homing starts.



**Precautions for Correct Use**

For an OMRON G5-series Linear Motor Type Servo Drive with built-in EtherCAT communications, the Z-phase input cannot be mapped to a PDO. Therefore, if you use Homing Operation Mode **13: No Home Proximity Input/Holding Home Input**, which can use a Z-phase input mapped to a PDO, do not select the Z-phase input for the home input signal.

● **14: Zero Position Preset Operation**

The command current position is set to the home position offset to define home.

Also, the following error between the command current position and the actual position is retained.

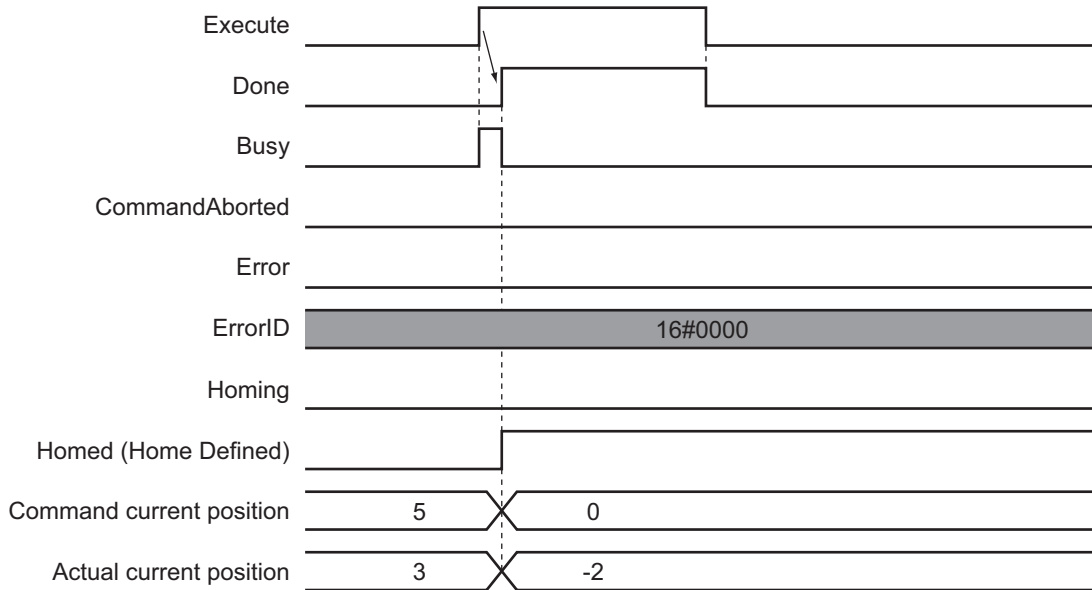

## Instruction Details

This section describes the instruction in detail.

### ● Axis Stopping Method and In-position Check When Homing

The axis is stopped with the following procedure when homing.

- 1** The actual position where the home input signal was detected is latched and the axis stops immediately.
- 2** After the immediate stop, the axis moves with absolute travel in the reverse direction to the position that was latched in step 1.

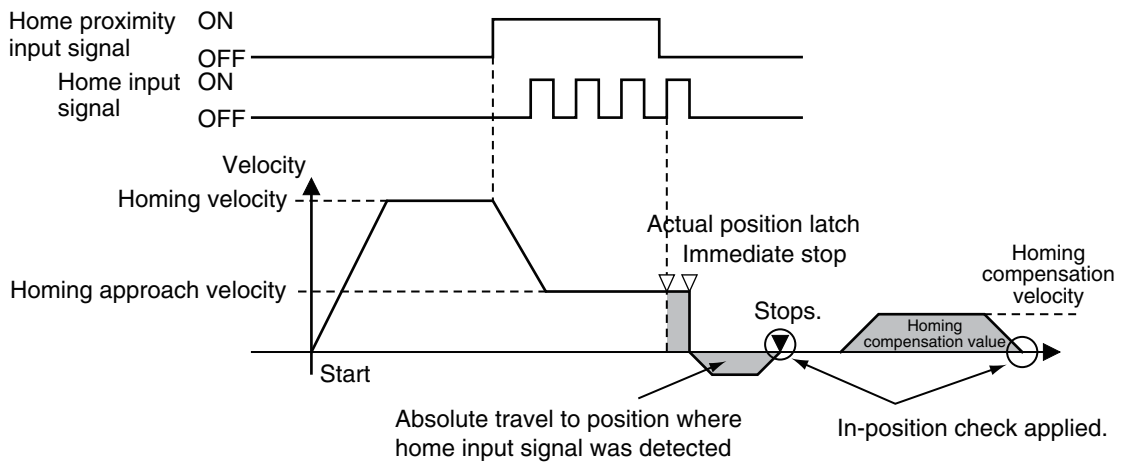

- Waiting for the in-position state is always performed for this instruction regardless of the setting of the **In-position Check Time** axis parameter. Be particularly careful when performing absolute travel to the home input signal detection position if the In-position Check Time is set to 0 because the instruction will continue waiting for the in-position status. Make sure that the signal is received within the in-position range.

In-position waiting is not performed for the homing compensation value operation even if the in-position check time is set to 0.

The status of in-position waiting can be checked with the *InPosWaiting* (In-position Waiting) system-defined variable for motion control.

## ● Homing Compensation

When you set a homing compensation value, the axis will move by the homing compensation value after the home input is detected to define home.

Adjusting the workpiece is sometimes difficult after home has been defined in the mechanical system. You can use the homing compensation to fine-tune the position of home after it is defined.

The travel velocity at this time is the homing compensation velocity. The axis starts moving 500 ms after it stopped when the home input was detected.

The sign of the homing compensation value indicates the direction relative to the coordinate axis. If it is negative, the axis moves in the negative direction.

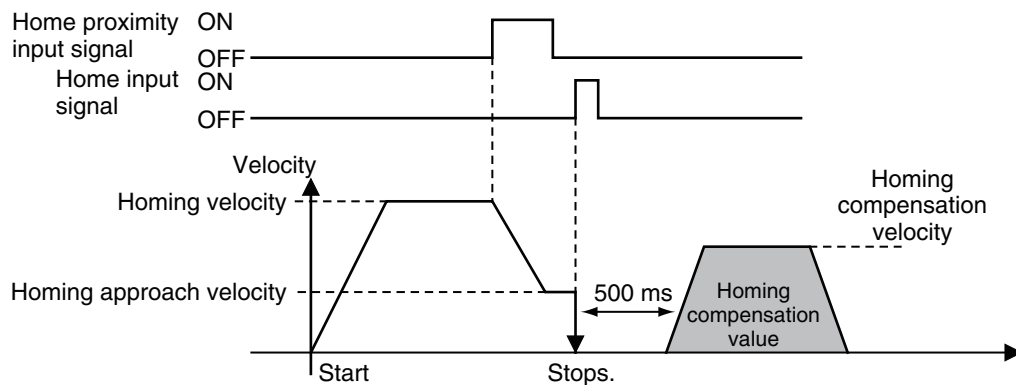

## ● Overrides

Overrides are disabled for this instruction.

## ● Automatic Control of Torque Limit

If you are using an OMRON 1S-series Servo Drive or G5-series Servo Drive, and you select either **12: Proximity Reverse Turn/Holding Time** or **13: No Home Proximity Input/Holding Home Input** for the homing operation, the torque limit will be automatically started in the holding direction.

The torque limit is released when the axis moves in the direction opposite to the home input detection direction.

The torque limit is automatically released at the following times.

- When the Servo is turned OFF (Servo Unlock)
- When the Cyclic Synchronous Position (CSP) Control Mode is changed to another control mode.

During the homing operation, torque limits are released for operation in the direction opposite to the home input detection direction.

For example, if the reversal operation direction at a limit input is in the direction opposite to the home input detection direction, the torque limit is released when the reversal operation is completed.

If the operation direction reverses again and becomes the home input detection direction, the torque limit will be enabled again.

## ● Holding Operation for OMRON 1S-series Servo Drives

Torque limits that are set in the Servo Drive in advance are used for the Homing Operation Modes, **12: Proximity Reverse Turn/Holding Time** and **13: No Home Proximity Input/Holding Home Input**, to automatically start torque control in the home input detection direction.



### Precautions for Correct Use

The automatic torque limit function of the MC\_Home instruction is not used for servo drives from other manufacturers.

Use the MC\_SetTorqueLimit instruction, SDO communications, or support software to set suitable values.



### Additional Information

- The torque limits are continued even after a normal completion of homing.
- The torque limits are automatically released when an instruction that moves the axis in the opposite direction is executed.

### Settings for OMRON 1S-series Servo Drives

To use the holding operation, you must set the **Torque Limit - Switch Selection** (3330-01 hex) for the 1S-series Servo Drive with the Sysmac Studio.

- Set the Torque Limit - Switch Selection to 2 to apply a torque limit in the home input detection direction during the holding operation for homing and to use the torque limit directions and values that are set with the MC\_SetTorqueLimit instruction for other operations.  
In that case, the values of the input variables to the MC\_SetTorqueLimit instruction are ignored during the holding operation for homing.
- If the Torque Limit - Switch Selection is set to 0, the values of the input variables to the MC\_SetTorqueLimit instruction are always used. You must set torque limits that are suitable both for the holding operation during homing and for other operations.

		Torque Limit - Switch Selection (3330-01 hex)	
		2	0
Positive Torque Limit	Homing	The <b>Torque Limit - Positive Torque Limit Value 2</b> (3330-05 hex) for the Servo Drive is used.	The <i>PositiveValue</i> (Positive Torque Limit) for the MC_SetTorqueLimit instruction is used.
	Operations other than Homing	The <i>PositiveValue</i> (Positive Torque Limit) for the MC_SetTorqueLimit instruction is used.	
Negative Torque Limit	Homing	The <b>Torque Limit - Negative Torque Limit Value 2</b> (3330-06 hex) for the Servo Drive is used.	The <i>NegativeValue</i> (Negative Torque Limit) for the MC_SetTorqueLimit instruction is used.
	Operations other than Homing	The <i>NegativeValue</i> (Negative Torque Limit) for the MC_SetTorqueLimit instruction is used.	

For details on torque limits, refer to *MC\_SetTorqueLimit* on page 3-351.

Also, for details on the settings of 1S-series Servo Drives, refer to the *AC Servomotors/Servo Drives 1S-series with Built-in EtherCAT Communications User's Manual (Cat. No. I586)* or *AC Servomotors/Servo Drives 1S-series with Built-in EtherCAT Communications and Safety Functionality User's Manual (Cat. No. I621)*.

## ● Holding Operation for OMRON G5-series Servo Drives

Torque limits that are set in the Servo Drive in advance are used for the Homing Operation Modes, **12: Proximity Reverse Turn/Holding Time** and **13: No Home Proximity Input/Holding Home Input**, to automatically start torque control in the home input detection direction.



### Precautions for Correct Use

The automatic torque limit function of the MC\_Home instruction is not used for servo drives from other manufacturers.

Use the MC\_SetTorqueLimit instruction, SDO communications, or support software to set suitable values.



### Additional Information

- The torque limits are continued even after a normal completion of homing.
- The torque limits are automatically released when an instruction that moves the axis in the opposite direction is executed.

### Settings for OMRON G5-series Servo Drives

To use the holding operation, you must use the support software of the Servo Drive to set the Torque Limit Selection (3521 hex) in the G5-series Servo Drive.

- Set the Torque Limit Selection to 6 to apply a torque limit in the home input detection direction during the holding operation for homing and to use the torque limit directions and values that are set with the MC\_SetTorqueLimit instruction for other operations.

In that case, the values of the input variables to the MC\_SetTorqueLimit instruction are ignored during the holding operation for homing.

- If the Torque Limit Selection is set to 4, the values of the input variables to the MC\_SetTorqueLimit instruction are always used. You must set torque limits that are suitable both for the holding operation during homing and for other operations.

		Torque Limit Selection (3521 hex)	
		6 (recommended)	4
Positive Torque Limit	Homing	Torque Limit 3 (3525 hex) is used.	The smaller of the <i>PositiveValue</i> (Positive Torque Limit) for the MC_SetTorqueLimit instruction and Torque Limit 1 (3013 hex) is used.
	Operations other than Homing	The smaller of the <i>PositiveValue</i> (Positive Torque Limit) for the MC_SetTorqueLimit instruction and Torque Limit 1 (3013 hex) is used.	
Negative Torque Limit	Homing	Torque Limit 4 (3526 hex) is used.	The smaller of the <i>NegativeValue</i> (Negative Torque Limit) for the MC_SetTorqueLimit instruction and Torque Limit 2 (3522 hex) is used.
	Operations other than Homing	The smaller of the <i>NegativeValue</i> (Negative Torque Limit) for the MC_SetTorqueLimit instruction and Torque Limit 2 (3522 hex) is used.	

For details on torque limits, refer to *MC\_SetTorqueLimit* on page 3-351.

For the settings for the G5-series Servo Drive, refer to the *AC Servomotors/Servo Drives G5-series with Built-in EtherCAT Communications User's Manual (Cat. No. I576)* or the *AC Servomotors/Servo Drives G5-series with Built-in EtherCAT Communications Linear Motor Type User's Manual (Cat. No. I577)*.

## ● Monitoring Following Error during Holding Operation

The following error is not monitored during the holding operation for homing.

For details on monitoring the following error, refer to the *NJ/NX-series CPU Unit Motion Control User's Manual (Cat. No. W507)*.

## Timing Charts

The following charts show the timing of homing.

### ● No Homing Compensation

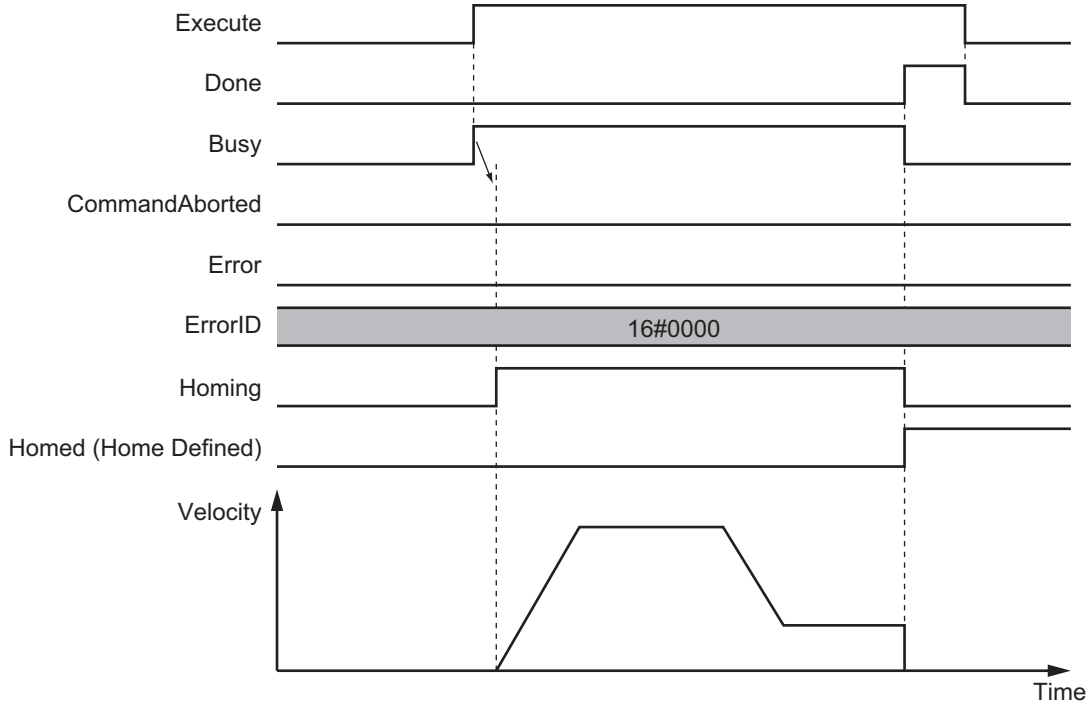

● With Homing Compensation

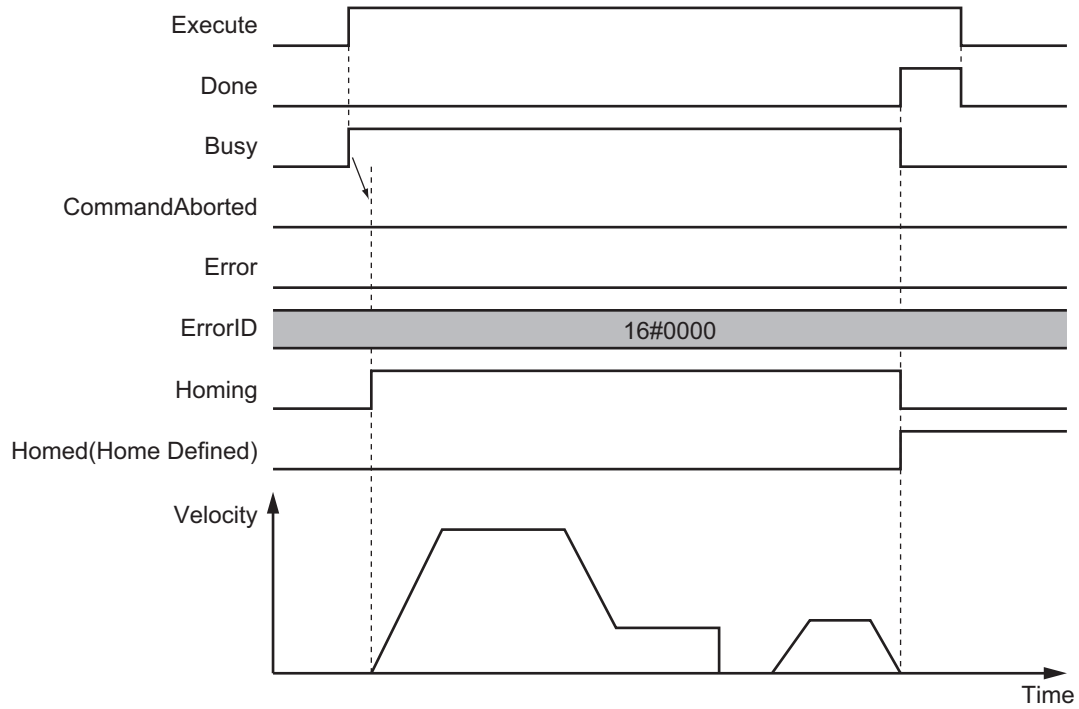

● Execution When Home Is Defined

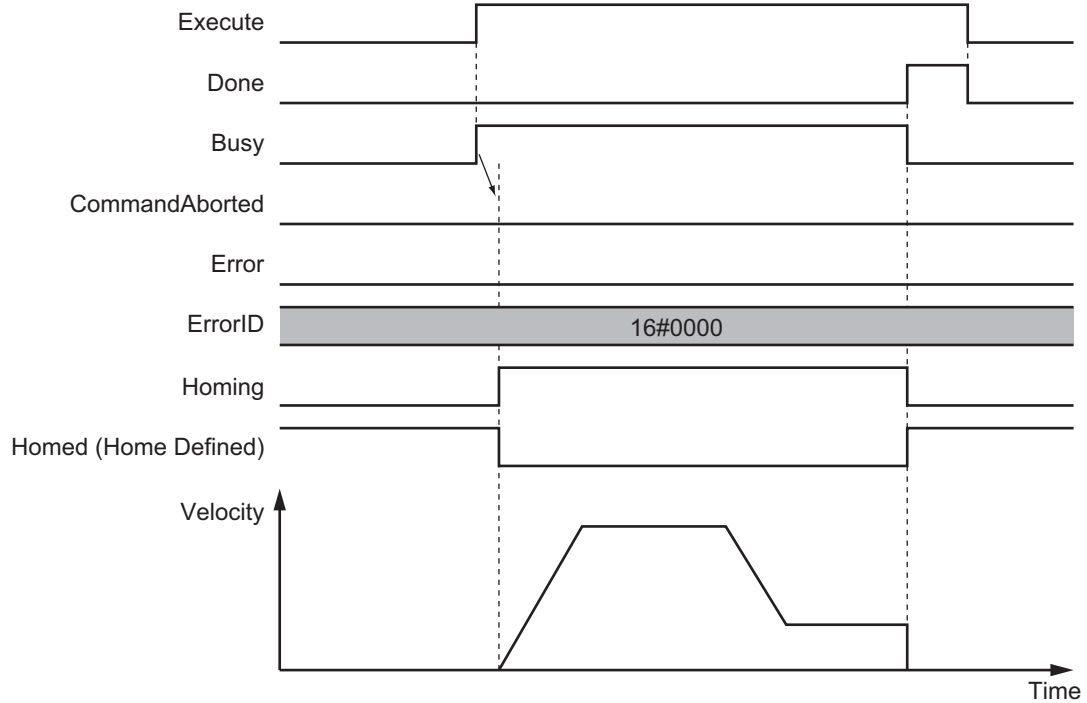

## ● Execution with Incorrect Parameters or When Motion Control Instructions Are Disabled

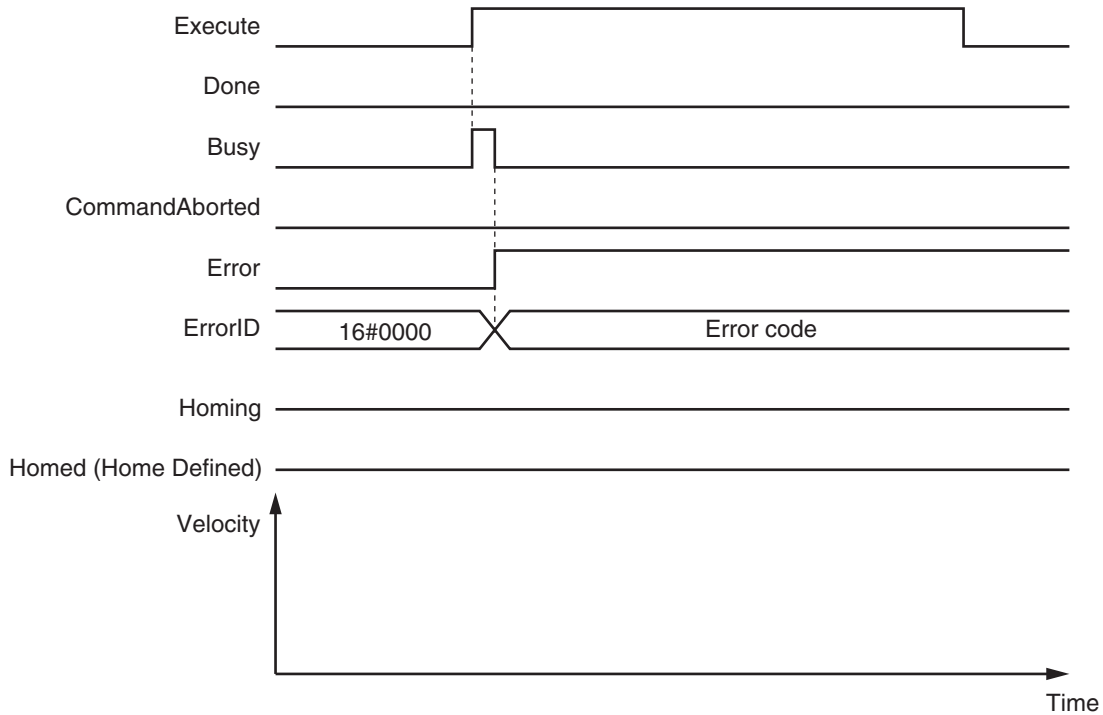

## Re-execution of Motion Control Instructions

This instruction cannot be re-executed.

A Motion Control Instruction Re-execution Disabled error (error code: 543B hex) occurs if re-execution is attempted.

## Multi-execution of Motion Control Instructions

For details on multi-execution of motion control instructions, refer to the *NJ/NX-series CPU Unit Motion Control User's Manual (Cat. No. W507)*.

## Error Codes

Refer to the *NJ/NX-series Troubleshooting Manual (Cat. No. W503)* for instruction errors.



# MC\_HomeWithParameter

The MC\_HomeWithParameter instruction sets the homing parameter and operates the motor to determine home. It uses the limit signals, home proximity signal, and home signal.

Instruction	Name	FB/ FUN	Graphic expression	ST expression
MC_Home- WithParame- ter	Home with Parameters	FB		<pre>MC_HomeWithParameter_in- stance (   Axis :=parameter,   HomingParameter :=parameter,   Execute :=parameter,   Done =&gt;parameter,   Busy =&gt;parameter,   CommandAborted =&gt;parameter,   Error =&gt;parameter,   ErrorID =&gt;parameter );</pre>



## Version Information

A CPU Unit with unit version 1.03 or later and Sysmac Studio version 1.04 or higher are required to use this instruction.

## Variables

### Input Variables

Name	Meaning	Data type	Valid range	Default	Description
Execute	Execute	BOOL	TRUE or FALSE	FALSE	The instruction is executed when the value of this variable changes to TRUE.

### Output Variables

Name	Meaning	Data type	Valid range	Description
Done	Done	BOOL	TRUE or FALSE	TRUE when the instruction is completed.
Busy	Executing	BOOL	TRUE or FALSE	TRUE when the instruction is acknowledged.
CommandAborted	Command Aborted	BOOL	TRUE or FALSE	TRUE when the instruction is aborted.
Error	Error	BOOL	TRUE or FALSE	TRUE while there is an error.
ErrorID	Error Code	WORD	*1	Contains the error code when an error occurs. A value of 16#0000 indicates normal execution.

\*1. The upper four digits of the event code give the error code for ErrorID. Refer to the *NJ/NX-series Troubleshooting Manual (Cat. No. W503)* for the event codes.

## ● Output Variable Update Timing

Name	Timing for changing to TRUE	Timing for changing to FALSE
Done	When the instruction is completed.	<ul style="list-style-type: none"> <li>When <i>Execute</i> is TRUE and changes to FALSE.</li> <li>After one period when <i>Execute</i> is FALSE.</li> </ul>
Busy	When <i>Execute</i> changes to TRUE.	<ul style="list-style-type: none"> <li>When <i>Done</i> changes to TRUE.</li> <li>When <i>Error</i> changes to TRUE.</li> <li>When <i>CommandAborted</i> changes to TRUE.</li> </ul>
CommandAborted	<ul style="list-style-type: none"> <li>When this instruction is aborted because another motion control instruction was executed with the Buffer Mode set to <b>Aborting</b>.</li> <li>When this instruction is canceled due to an error.</li> <li>When this instruction is executed while there is an error.</li> <li>When you start this instruction during MC_Stop instruction execution.</li> </ul>	<ul style="list-style-type: none"> <li>When <i>Execute</i> is TRUE and changes to FALSE.</li> <li>After one period when <i>Execute</i> is FALSE.</li> </ul>
Error	When there is an error in the execution conditions or input parameters for the instruction.	When the error is cleared.

## In-Out Variables

Name	Meaning	Data type	Valid range	Description
Axis	Axis	_sAXIS_REF	---	Specify the axis. *1
HomingParameter	Homing Parameter	_sHOMING_REF	---	Set the homing parameter. *2

\*1. Specify a user-defined Axis Variable that was created in the Axis Basic Settings of the Sysmac Studio (default: MC\_Axis\*) or a system-defined axis variable name (\_MC\_AX[\*], \_MC1\_AX[\*] or \_MC2\_AX[\*]).

If you use Sysmac Studio version 1.29 or higher, you can specify the system-defined axis variable name for AT specification of a user-defined variable. This will allow you to specify the user-defined variable.

If you use Sysmac Studio version 1.28 or lower, do not specify any user-defined variable created in the variable table.

\*2. Define a user-defined variable with a data type of \_sHOMING\_REF.

## ● \_sHOMING\_REF

Name	Meaning	Data type	Valid range	Function
HomingMode	Homing Method	_eMC_HOMING_MODE	0: _mcHomeSwTurnHomeSwOff 1: _mcHomeSwTurnHomeSwOn 4: _mcHomeSwOff 5: _mcHomeSwOn 8: _mcLimitInputOff 9: _mcHomeSwTurnHomeMask 11: _mcLimitInputOnly 12: _mcHomeSwTurnHoldingTime 13: _mcNoHomeSwHoldingHomeInput 14: _mcHomePreset	Specify the new setting of the Homing Method. 0: Proximity reverse turn/home proximity input OFF 1: Proximity reverse turn/home proximity input ON 4: Home proximity input OFF 5: Home proximity input ON 8: Limit input OFF 9: Proximity reverse turn/home input mask distance 11: Limit inputs only 12: Proximity reverse turn/holding time 13: No home proximity input/holding home input 14: Zero position preset

Name	Meaning	Data type	Valid range	Function
HomeInput	Home Input Signal	_eMC_HOME_INPUT	0: _mcZPhase 1: _mcExternalSignal	Select the input to use for the home input signal. 0: Use the Z-phase input as home. 1: Use external home input.* <sup>1</sup>
StartDir	Homing Start Direction	_eMC_DIRECTION	0: _mcPositiveDirection 2: _mcNegativeDirection	Set the start direction for when homing is started. 0: Positive direction 2: Negative direction
HomeDir	Home Input Detection Direction	_eMC_DIRECTION	0: _mcPositiveDirection 2: _mcNegativeDirection	Set the home input detection direction for homing. 0: Positive direction 2: Negative direction
PosiLmtMode	Operation Selection at Positive Limit Input	_eMC_LIMIT_REVERSE_MODE	0: _mcErrorStop 1: _mcRevImmediateStop 2: _mcRevDecelerationStop	Set the stopping method when the positive limit input turns ON during homing. 0: No reverse turn/minor fault stop (Stop according to Limit Input Stop Method parameter.) 1: Reverse turn/immediate stop 2: Reverse turn/deceleration stop
NegaLmt-Mode	Operation Selection at Negative Limit Input	_eMC_LIMIT_REVERSE_MODE	0: _mcErrorStop 1: _mcRevImmediateStop 2: _mcRevDecelerationStop	Set the stopping method when the negative limit input turns ON during homing. 0: No reverse turn/minor fault stop (Stop according to Limit Input Stop Method parameter.) 1: Reverse turn/immediate stop 2: Reverse turn/deceleration stop
Vel	Homing Velocity	LREAL	Positive number	Set the homing velocity. Set the homing velocity to a value that is less than the maximum velocity and greater than or equal to the homing approach velocity. The unit is command units/s. * <sup>2</sup>
ApproachVel	Homing Approach Velocity	LREAL	Positive number	Set the velocity to use after the home proximity input turns ON. Set the homing velocity to a value that is less than the maximum velocity and greater than or equal to the homing approach velocity. The unit is command units/s. * <sup>2</sup>
Acc	Homing Acceleration	LREAL	Non-negative number	Set the acceleration rate for homing. Set 0 for no acceleration. The unit is command units/s <sup>2</sup> . * <sup>2</sup>
Dec	Homing Deceleration	LREAL	Non-negative number	Set the deceleration rate for homing. Set 0 for no deceleration. The unit is command units/s <sup>2</sup> . * <sup>2</sup>
Jerk	Homing Jerk	LREAL	Non-negative number	Set the jerk for homing. Set 0 for no jerk. Set the value to within the range of 40-bit data for pulses. The unit is command units/s <sup>3</sup> . * <sup>2</sup>

Name	Meaning	Data type	Valid range	Function
Mask	Home Input Mask Distance	LREAL	Non-negative number	Set the home input mask distance when you set the Homing Operation Mode to <b>Proximity Reverse Turn/Home Input Mask Distance</b> . The unit is command units. *2
Offset	Home Offset	LREAL	Negative number, positive number, or 0	Preset the actual position for the value that is set after homing. In Rotary Mode, set the Home Offset parameter so that it is greater than or equal to the modulo minimum position and less than the modulo maximum position. Also set the value to within the range of 40-bit data for pulses. The unit is command units. *2
PushTime	Homing Holding Time	UINT	0 to 10,000	Set the holding time when you set the Homing Operation Mode to <b>Proximity Reverse Turn/Holding Time</b> . The unit is milliseconds.
Compensation	Homing Compensation Value	LREAL	Negative number, positive number, or 0	Set the homing compensation value that is applied after the home is defined. In Rotary Mode, set the homing compensation value so that the absolute value of the homing compensation value is less than the absolute value of the difference between the modulo maximum position and modulo minimum position. Also set the value to within the range of 40-bit data for pulses. The unit is command units. *2
CompensationVel	Homing Compensation Velocity	LREAL	Positive number	Set the velocity to use for homing compensation. Set the value to less than the maximum velocity. The unit is command units/s. *2

\*1. This setting can be used for an OMRON 1S-series Servo Drive and G5-series Servo Drive. The input allocated to latch 1 for the Servo Drive is used as the external home input. In the default setting of the OMRON 1S-series Servo Drives and G5-series Servo Drives, the external latch input 1 is allocated to latch 1.

For details, refer to the *AC Servomotors/Servo Drives 1S-series with Built-in EtherCAT Communications User's Manual (Cat. No. I586)*, *AC Servomotors/Servo Drives 1S-series with Built-in EtherCAT Communications and Safety Functionality User's Manual (Cat. No. I621)*, *AC Servomotors/Servo Drives G5-series with Built-in EtherCAT Communications User's Manual (Cat. No. I576)* or the *AC Servomotors/Servo Drives G5-series with Built-in EtherCAT Communications Linear Motor Type User's Manual (Cat. No. I577)*.

\*2. Refer to *Unit Conversion Settings* in the *NJ/NX-series CPU Unit Motion Control User's Manual (Cat. No. W507)* for information on command units.

## Function

- Homing starts when *Execute* changes to TRUE for the axis specified in *Axis*.
- Set the parameters used by the *MC\_HomeWithParameter* instruction in the *HomingParameter* in-out variable.
- The axis parameters are not changed when this instruction is executed.

- The only difference between this instruction and the MC\_Home instruction is how the parameters are set. For this instruction, the parameters are set in the *HomingParameter* in-out variable. For the MC\_Home instruction, the parameters are set in the **Homing Method** of the axis parameters in the Sysmac Studio.

Refer to *MC\_Home* on page 3-18 for all instruction specifications except for how to set the parameters.



#### Precautions for Correct Use

The homing parameters that are set in this instruction are valid only when this instruction is executed. If you execute the MC\_Home instruction after this instruction, operation will be based on the homing parameters that are set in the axis parameters.

## Relationship between the Homing Method and Homing Parameters

Some of the homing parameters are not used depending on the setting of the homing method. Range and consistency checks are not performed for the parameters that are not used. Range and consistency checks are performed when the instruction is executed.

The following table shows the homing parameters that are used for each homing method.

(○: Parameter is used, ---: Parameter is not used.)

Homing method	Homing parameter														
	Home Input Signal	Homing Start Direction	Home Input Detection Direction	Operation Selection at Positive Limit Input	Operation Selection at Negative Limit Input	Homing Velocity	Homing Approach Velocity	Homing Acceleration	Homing Deceleration	Homing Jerk	Home Input Mask Distance	Home Offset	Homing Holding Time	Homing Compensation Value	Homing Compensation Velocity
Proximity reverse turn/home proximity input OFF	○	○	○	○	○	○	○	○	○	○	---	○	---	○	○
Proximity reverse turn/home proximity input ON	○	○	○	○	○	○	○	○	○	○	---	○	---	○	○
Home proximity input OFF	○	○	○	○	○	○	○	○	○	○	---	○	---	○	○
Home proximity input ON	○	○	○	○	○	○	○	○	○	○	---	○	---	○	○
Limit input OFF	○	○	○	○	○	○	○	○	○	○	---	○	---	○	○
Proximity reverse turn/home input mask distance	○	○	○	○	○	○	○	○	○	○	○	○	---	○	○
Limit inputs only	---	○	○	○	○	○	○	○	○	○	---	○	---	○	○
Proximity reverse turn/holding time	---	○	○	○	○	○	○	○	○	○	---	○	○	○	○

	Homing parameter															
	Home Input Signal	Homing Start Direction	Home Input Detection Direction	Operation Selection at Positive Limit Input	Operation Selection at Negative Limit Input	Homing Velocity	Homing Approach Velocity	Homing Acceleration	Homing Deceleration	Homing Jerk	Home Input Mask Distance	Home Offset	Homing Holding Time	Homing Compensation Value	Homing Compensation Velocity	
Homing method																
No home proximity input/holding home input	○	○	○	○	○	○	○	○	○	○	---	○	---	○	○	○
Zero position preset	---	---	---	---	---	---	---	---	---	---	---	○	---	---	---	---



#### Additional Information

If you use NX-series Position Interface Units, do not select holding for the Homing Operation Mode. Refer to the *NX-series Position Interface Units User's Manual (Cat. No. W524)* for details.

## Re-execution of Motion Control Instructions

This instruction cannot be re-executed.

A Motion Control Instruction Re-execution Disabled error (error code: 543B hex) occurs if re-execution is attempted.

## Multi-execution of Motion Control Instructions

For details on multi-execution of motion control instructions, refer to the *NJ/NX-series CPU Unit Motion Control User's Manual (Cat. No. W507)*.

## Error Codes

Refer to the *NJ/NX-series Troubleshooting Manual (Cat. No. W503)* for instruction errors.

# MC\_Move

The MC\_Move instruction performs absolute positioning or relative positioning.

Instruction	Name	FB/ FUN	Graphic expression	ST expression
MC_Move	Positioning	FB		<pre>MC_Move_instance (   Axis :=parameter,   Execute :=parameter,   Position :=parameter,   Velocity :=parameter,   Acceleration :=parameter,   Deceleration :=parameter,   Jerk :=parameter,   Direction :=parameter,   BufferMode :=parameter,   MoveMode :=parameter,   Done =&gt;parameter,   Busy =&gt;parameter,   Active =&gt;parameter,   CommandAborted =&gt;parameter,   Error =&gt;parameter,   ErrorID =&gt;parameter );</pre>

## Variables

### Input Variables

Name	Meaning	Data type	Valid range	De- fault	Description
Execute	Execute	BOOL	TRUE or FALSE	FALSE	The instruction is executed when the value of this variable changes to TRUE.
Position	Target Position	LREAL	Negative number, positive number, or 0	0	Specify the target position in absolute coordinates when you specify absolute positioning as the Travel Mode. Specify the relative position when you specify relative positioning as the Travel Mode. The unit is command units.*1
Velocity	Target Velocity	LREAL	Positive number	0	Specify the target velocity.*2 The unit is command units/s.*1
Acceleration	Acceleration Rate	LREAL	Non-negative number	0	Specify the acceleration rate. The unit is command units/s <sup>2</sup> .*1
Deceleration	Deceleration Rate	LREAL	Non-negative number	0	Specify the deceleration rate. The unit is command units/s <sup>2</sup> .*1

Name	Meaning	Data type	Valid range	Default	Description
Jerk	Jerk	LREAL	Non-negative number	0	Specify the jerk. The unit is command units/s <sup>3</sup> . <sup>*1</sup>
Direction	Direction	_eMC_DIRECTION	0: _mcPositiveDirection 1: _mcShortestWay 2: _mcNegativeDirection 3: _mcCurrentDirection 4: _mcNoDirection	0 <sup>*3</sup>	Specify the direction of rotation when <i>MoveMode</i> is set to <b>0</b> : <b>Absolute positioning</b> <sup>*4</sup> and when the Count Mode is <b>Rotary Mode</b> . 0: Positive direction 1: Shortest way 2: Negative direction 3: Current direction 4: No direction specified
BufferMode	Buffer Mode Selection	_eMC_BUFFER_MODE	0: _mcAborting 1: _mcBuffered 2: _mcBlendingLow 3: _mcBlendingPrevious 4: _mcBlendingNext 5: _mcBlendingHigh	0 <sup>*3</sup>	Specify the operation when executing more than one motion instruction. 0: Aborting 1: Buffered 2: Blending low 3: Blending previous 4: Blending next 5: Blending high
MoveMode	Travel Mode	_eMC_MOVE_MODE	0: _mcAbsolute 1: _mcRelative	0 <sup>*3</sup>	Select the travel method. 0: Absolute positioning 1: Relative positioning

\*1. Refer to *Unit Conversion Settings* in the *NJ/NX-series CPU Unit Motion Control User's Manual (Cat. No. W507)* for information on command units.

\*2. Always set the target velocity. A Target Velocity Setting Out of Range error (error code: 5422 hex) occurs when the instruction is executed if the target velocity is not set.

\*3. The default value for an enumeration variable is actually not the number, but the enumerator.

\*4. When *MoveMode* is set to **1: Relative positioning**, the travel direction is determined by the sign of the position.

## Output Variables

Name	Meaning	Data type	Valid range	Description
Done	Done	BOOL	TRUE or FALSE	TRUE when the instruction is completed.
Busy	Executing	BOOL	TRUE or FALSE	TRUE when the instruction is acknowledged.
Active	Controlling	BOOL	TRUE or FALSE	TRUE when the axis is being controlled.
CommandAborted	Command Aborted	BOOL	TRUE or FALSE	TRUE when the instruction is aborted.
Error	Error	BOOL	TRUE or FALSE	TRUE while there is an error.
ErrorID	Error Code	WORD	*1	Contains the error code when an error occurs. A value of 16#0000 indicates normal execution.

\*1. The upper four digits of the event code give the error code for ErrorID. Refer to the *NJ/NX-series Troubleshooting Manual (Cat. No. W503)* for the event codes.



## ● Output Variable Update Timing

Name	Timing for changing to TRUE	Timing for changing to FALSE
Done	When positioning is completed.	<ul style="list-style-type: none"> <li>When <i>Execute</i> is TRUE and changes to FALSE.</li> <li>After one period when <i>Execute</i> is FALSE.</li> </ul>
Busy	When <i>Execute</i> changes to TRUE.	<ul style="list-style-type: none"> <li>When <i>Done</i> changes to TRUE.</li> <li>When <i>Error</i> changes to TRUE.</li> <li>When <i>CommandAborted</i> changes to TRUE.</li> </ul>
Active	When the instruction is started.	<ul style="list-style-type: none"> <li>When <i>Done</i> changes to TRUE.</li> <li>When <i>Error</i> changes to TRUE.</li> <li>When <i>CommandAborted</i> changes to TRUE.</li> </ul>
CommandAborted	<ul style="list-style-type: none"> <li>When this instruction is aborted because another motion control instruction was executed with the Buffer Mode set to <b>Aborting</b>.</li> <li>When this instruction is canceled due to an error.</li> <li>When this instruction is executed while there is an error.</li> <li>When you start this instruction during MC_Stop instruction execution.</li> </ul>	<ul style="list-style-type: none"> <li>When <i>Execute</i> is TRUE and changes to FALSE.</li> <li>After one period when <i>Execute</i> is FALSE.</li> </ul>
Error	When there is an error in the execution conditions or input parameters for the instruction.	When the error is cleared.

## In-Out Variables

Name	Meaning	Data type	Valid range	Description
Axis	Axis	_sAXIS_REF	---	Specifies the axis. *1

\*1. Specify a user-defined Axis Variable that was created in the Axis Basic Settings of the Sysmac Studio (default: MC\_Axis\*) or a system-defined axis variable name (\_MC\_AX[\*], \_MC1\_AX[\*], or \_MC2\_AX[\*]).

If you use Sysmac Studio version 1.29 or higher, you can specify the system-defined axis variable name for AT specification of a user-defined variable. This will allow you to specify the user-defined variable.

If you use Sysmac Studio version 1.28 or lower, do not specify any user-defined variable created in the variable table.

## Function

- You can use the MC\_Move instruction to perform absolute positioning or relative positioning.
- If you specify **Absolute positioning** for *MoveMode* (Travel Mode), the operation is the same as for the MC\_MoveAbsolute (Absolute Positioning) instruction.  
If you specify **Relative positioning**, the operation is the same as the MC\_MoveRelative (Relative Positioning) instruction.
- If relative positioning is used, *Direction* is not used.

For details, refer to *MC\_MoveAbsolute* on page 3-52 or *MC\_MoveRelative* on page 3-79.

## Instruction Details

This section describes the instruction in detail.



### Precautions for Correct Use

When you perform absolute positioning, set the target position so that the settings of the **Modulo Maximum Position Setting Value** and **Modulo Minimum Position Setting Value** axis parameters are not exceeded.

If the target position is set outside of the settings of the **Modulo Maximum Position Setting Value** and **Modulo Minimum Position Setting Value** axis parameters, a Target Position Setting Out of Range error (error code 5478 hex) will occur.

### ● In-position Check

An in-position check is performed for this instruction according to the settings in **In-position Range** and **In-position Check Time** axis parameters.

## Re-execution of Motion Control Instructions

You can change the operation of the instruction if you change an input variable during positioning and change *Execute* to TRUE again.

Input variables *Position* (Target Position), *Velocity* (Target Velocity), *Acceleration* (Acceleration Rate), and *Deceleration* (Deceleration Rate) can be changed by re-executing the motion control instruction.

For details on re-execution of motion control instructions, refer to the *NJ/NX-series CPU Unit Motion Control User's Manual (Cat. No. W507)*.

## Multi-execution of Motion Control Instructions

For details on multi-execution of motion control instructions, refer to the *NJ/NX-series CPU Unit Motion Control User's Manual (Cat. No. W507)*.

### ● Execution during Execution of Other Instructions

You can switch to this instruction or buffer this instruction if you execute it during execution of another instruction.

You can buffer one instruction per axis.

Specify the operation of this instruction with *BufferMode* (Buffer Mode Selection) for multi-execution of instructions.

Buffer Mode Selection	Description
Aborting	Aborts the instruction being executed and switches to this instruction. If the direction of axis motion is reversed by switching instructions, the motion will be reversed according to the <b>Operation Selection at Reversing</b> axis parameter.
Buffered	Buffers this instruction and executes it automatically after the current instruction is completed.
Blending	Starts the buffered instruction at the velocity (transit velocity) at which the current instruction reaches the target position. The operation of the current instruction is changed so that the axes reach the target position at the transit velocity. There are four methods to specify the transit velocity. These are described below.

Buffer Mode Selection	Description
Blending low	The lower of the target velocities of the current instruction and the buffered instruction is used as the transit velocity.
Blending previous	The target velocity of the current instruction is used as the transit velocity.
Blending next	The target velocity of the buffered instruction is used as the transit velocity.
Blending high	The higher of the target velocities of the current instruction and the buffered instruction is used as the transit velocity.

For details on *BufferMode* (Buffer Mode Selection), refer to the *NJ/NX-series CPU Unit Motion Control User's Manual (Cat. No. W507)*.

### ● Execution of Other Instructions during Instruction Execution

If you execute another instruction during execution of this instruction, you can specify **Aborting**, **Buffered**, or **Blending**.

## Errors

If an error occurs during instruction execution, *Error* will change to TRUE.

You can find out the cause of the error by referring to the value output by *ErrorID* (Error Code).

### ● Timing Chart When Error Occurs

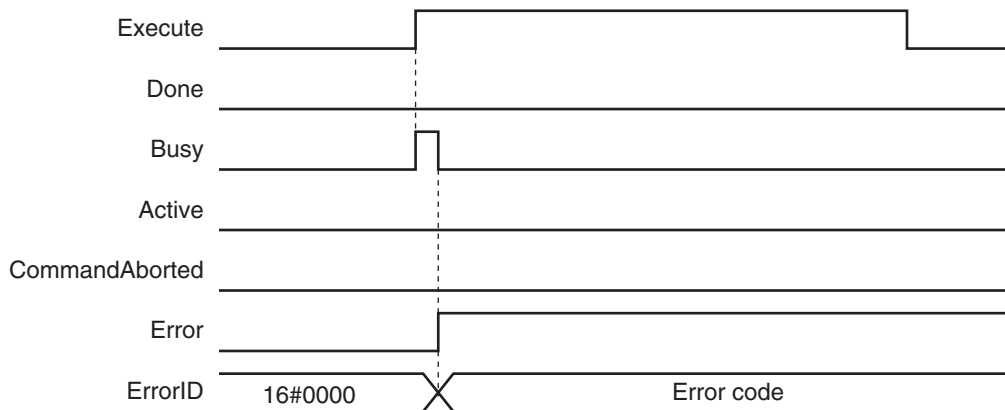

### ● Error Codes

Refer to the *NJ/NX-series Troubleshooting Manual (Cat. No. W503)* for instruction errors.

# MC\_MoveAbsolute

The MC\_MoveAbsolute instruction moves the axis to a specified absolute target position.

Instruction	Name	FB/ FUN	Graphic expression	ST expression
MC_MoveAbsolute	Absolute Positioning	FB		<pre>MC_MoveAbsolute_instance (   Axis :=parameter,   Execute :=parameter,   Position :=parameter,   Velocity :=parameter,   Acceleration :=parameter,   Deceleration :=parameter,   Jerk :=parameter,   Direction :=parameter,   BufferMode :=parameter,   Done =&gt;parameter,   Busy =&gt;parameter,   Active =&gt;parameter,   CommandAborted =&gt;parameter,   Error =&gt;parameter,   ErrorID =&gt;parameter );</pre>

## Variables

### Input Variables

Name	Meaning	Data type	Valid range	Default	Description
Execute	Execute	BOOL	TRUE or FALSE	FALSE	The instruction is executed when the value of this variable changes to TRUE.
Position	Target Position	LREAL	Negative number, positive number, or 0	0	Specify the absolute target position. The unit is command units.*1
Velocity	Target Velocity	LREAL	Positive number	0	Specify the target velocity.*2 The unit is command units/s.*1
Acceleration	Acceleration Rate	LREAL	Non-negative number	0	Specify the acceleration rate. The unit is command units/s <sup>2</sup> . *1
Deceleration	Deceleration Rate	LREAL	Non-negative number	0	Specify the deceleration rate. The unit is command units/s <sup>2</sup> . *1
Jerk	Jerk	LREAL	Non-negative number	0	Specify the jerk. The unit is command units/s <sup>3</sup> . *1

Name	Meaning	Data type	Valid range	Default	Description
Direction	Direction	_eMC_DIRECTION	0: _mcPositiveDirection 1: _mcShortestWay 2: _mcNegativeDirection 3: _mcCurrentDirection 4: _mcNoDirection	0*3	Specify the direction of rotation when the Count Mode is <b>Rotary Mode</b> . 0: Positive direction 1: Shortest way 2: Negative direction 3: Current direction 4: No direction specified
BufferMode	Buffer Mode Selection	_eMC_BUFFER_MODE	0: _mcAborting 1: _mcBuffered 2: _mcBlendingLow 3: _mcBlendingPrevious 4: _mcBlendingNext 5: _mcBlendingHigh	0*3	Specify the behavior when executing more than one motion instruction. 0: Aborting 1: Buffered 2: Blending low 3: Blending previous 4: Blending next 5: Blending high

\*1. Refer to *Unit Conversion Settings* in the *NJ/NX-series CPU Unit Motion Control User's Manual (Cat. No. W507)* for information on command units.

\*2. Always set the target velocity. If the axis is moved without setting a target velocity, an error will occur.

\*3. The default value for an enumeration variable is actually not the number, but the enumerator.

## Output Variables

Name	Meaning	Data type	Valid range	Description
Done	Done	BOOL	TRUE or FALSE	TRUE when the instruction is completed.
Busy	Executing	BOOL	TRUE or FALSE	TRUE when the instruction is acknowledged.
Active	Controlling	BOOL	TRUE or FALSE	TRUE when the axis is being controlled.
CommandAborted	Command Aborted	BOOL	TRUE or FALSE	TRUE when the instruction is aborted.
Error	Error	BOOL	TRUE or FALSE	TRUE while there is an error.
ErrorID	Error Code	WORD	*1	Contains the error code when an error occurs. A value of 16#0000 indicates normal execution.

\*1. The upper four digits of the event code give the error code for ErrorID. Refer to the *NJ/NX-series Troubleshooting Manual (Cat. No. W503)* for the event codes.

### ● Output Variable Update Timing

Name	Timing for changing to TRUE	Timing for changing to FALSE
Done	When positioning is completed.	<ul style="list-style-type: none"> <li>When <i>Execute</i> is TRUE and changes to FALSE.</li> <li>After one period when <i>Execute</i> is FALSE.</li> </ul>
Busy	When <i>Execute</i> changes to TRUE.	<ul style="list-style-type: none"> <li>When <i>Done</i> changes to TRUE.</li> <li>When <i>Error</i> changes to TRUE.</li> <li>When <i>CommandAborted</i> changes to TRUE.</li> </ul>

Name	Timing for changing to TRUE	Timing for changing to FALSE
Active	When the instruction is started.	<ul style="list-style-type: none"> <li>When <i>Done</i> changes to TRUE.</li> <li>When <i>Error</i> changes to TRUE.</li> <li>When <i>CommandAborted</i> changes to TRUE.</li> </ul>
CommandAborted	<ul style="list-style-type: none"> <li>When this instruction is aborted because another motion control instruction was executed with the Buffer Mode set to <b>Aborting</b>.</li> <li>When this instruction is canceled due to an error.</li> <li>When this instruction is executed while there is an error.</li> <li>When you start this instruction during MC_Stop instruction execution.</li> </ul>	<ul style="list-style-type: none"> <li>When <i>Execute</i> is TRUE and changes to FALSE.</li> <li>After one period when <i>Execute</i> is FALSE.</li> </ul>
Error	When there is an error in the execution conditions or input parameters for the instruction.	When the error is cleared.

## In-Out Variables

Name	Meaning	Data type	Valid range	Description
Axis	Axis	_sAXIS_REF	---	Specifies the axis. *1

- \*1. Specify a user-defined Axis Variable that was created in the Axis Basic Settings of the Sysmac Studio (default: MC\_Axis\*) or a system-defined axis variable name (\_MC\_AX[\*], \_MC1\_AX[\*], or \_MC2\_AX[\*]).
- If you use Sysmac Studio version 1.29 or higher, you can specify the system-defined axis variable name for AT specification of a user-defined variable. This will allow you to specify the user-defined variable.
- If you use Sysmac Studio version 1.28 or lower, do not specify any user-defined variable created in the variable table.

## Function

- The absolute target position is specified to perform positioning.
- Absolute positioning starts when *Execute* changes to TRUE.
- You can execute this instruction even if home is not defined.
- You can specify the *Velocity* (Target Velocity), *Acceleration* (Acceleration Rate), *Deceleration* (Deceleration Rate), and *Jerk* as input variables.

The following chart shows an operation example of absolute positioning.

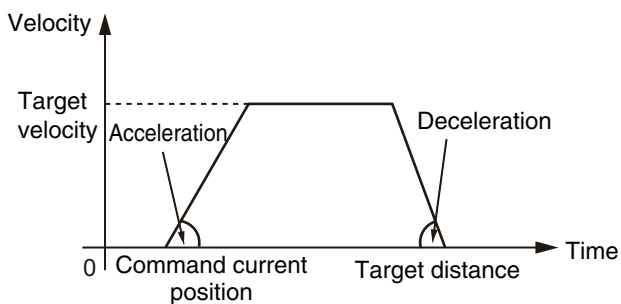

When the *Acceleration* (Acceleration Rate) or *Deceleration* (Deceleration Rate) is 0 and the instruction is executed, the axis will reach the target velocity without accelerating or decelerating.

The following chart shows an operation example of when the *Acceleration* (Acceleration Rate) is 0.

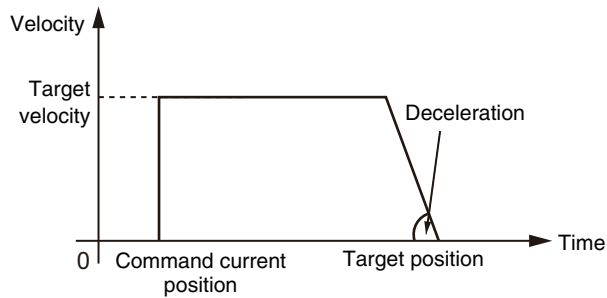

Specify *Jerk* when you want to accelerate or decelerate smoothly.  
The following chart shows an operation example when *Jerk* is specified.

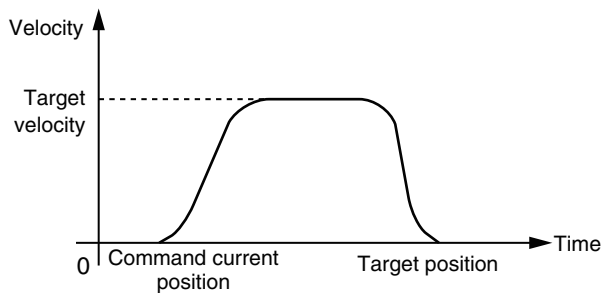

For details on *Jerk*, refer to the *NJ/NX-series CPU Unit Motion Control User's Manual (Cat. No. W507)*.

When the positioning is started with *Position* (Target Position) set to the command current position, the axis will not move but *Done* will change to TRUE.

## Instruction Details

This section describes the instruction in detail.

### ● Direction

*Direction* specifies the direction for starting positioning when the Count Mode is **Rotary Mode**.

*Direction* is not used if the Count Mode is **Linear Mode**.

Positioning starts in the positive direction towards the target position when 0: **\_mcPositiveDirection** (Positive direction) is specified for *Direction*.

The following chart shows an operation example when positioning starts with a command position of 50 and moves toward -20.

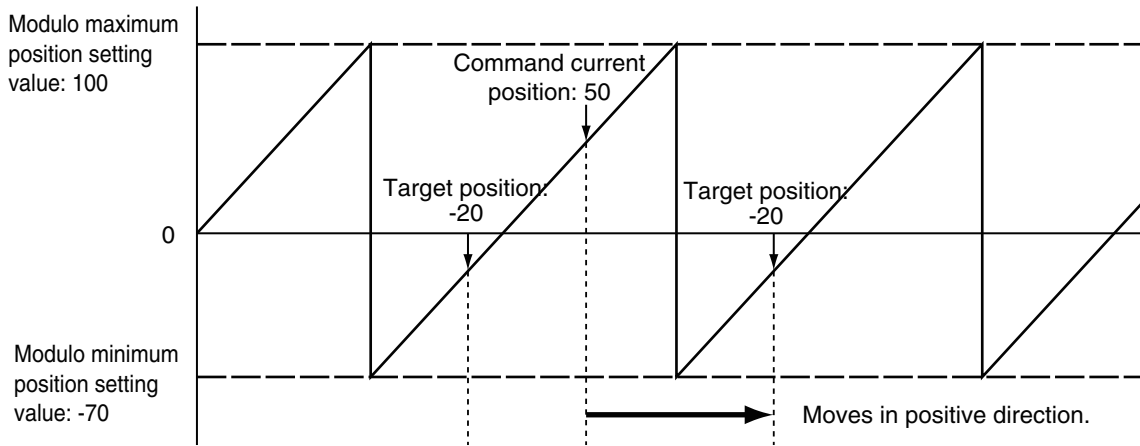

Positioning starts in the negative direction towards the target position when **2: `_mcNegativeDirection`** (Negative direction) is specified for *Direction*.

The following chart shows an operation example when positioning starts with a command position of 50 and moves toward -20.

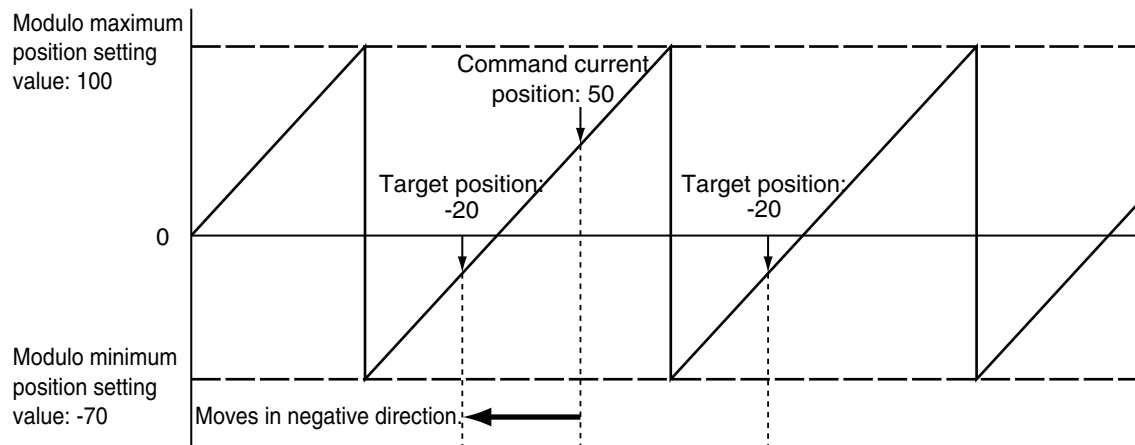

Positioning starts towards the target position within the ring counter range when **4: `_mcNoDirection`** (No direction specified) is specified for *Direction*. Therefore, the size relationship between the command current position and the target position determines the direction of travel.

The following chart shows an operation example when positioning starts with a command position of 50 and moves toward -20.

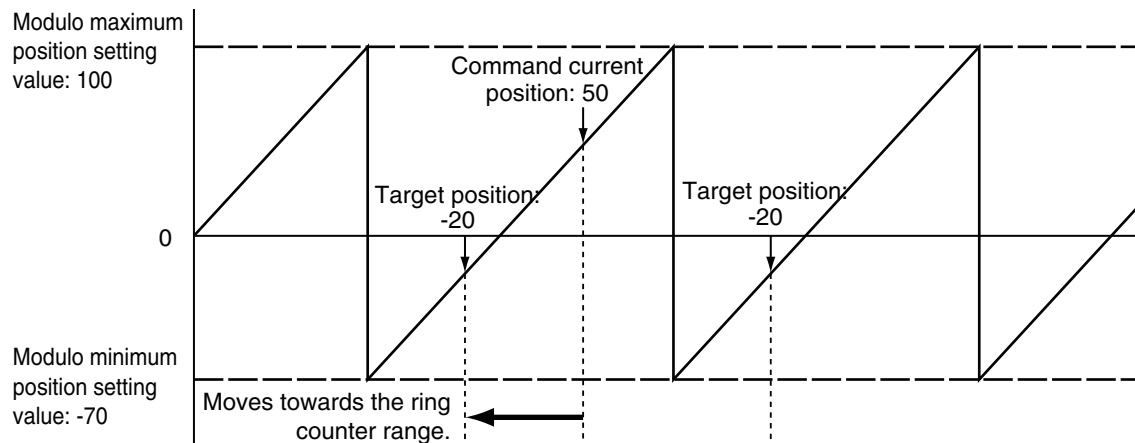



When **4: \_mcNoDirection** (No direction specified) is specified for *Direction*, you can specify a *Position* (Target Position) outside the range specified by the modulo maximum position and modulo minimum position setting values.

When *Position* (Target Position) is outside the range specified by the modulo maximum position and modulo minimum position setting values, positioning is performed using the travel distance exceeding the modulo maximum position setting value as a relative distance. This allows positioning of multiple ring rotations.

Positioning is the same when *Position* (Target Position) is below the modulo minimum position setting value as well.

The following chart shows an operation example for when the command current position is -20 and *Position* (Target Position) is 290.

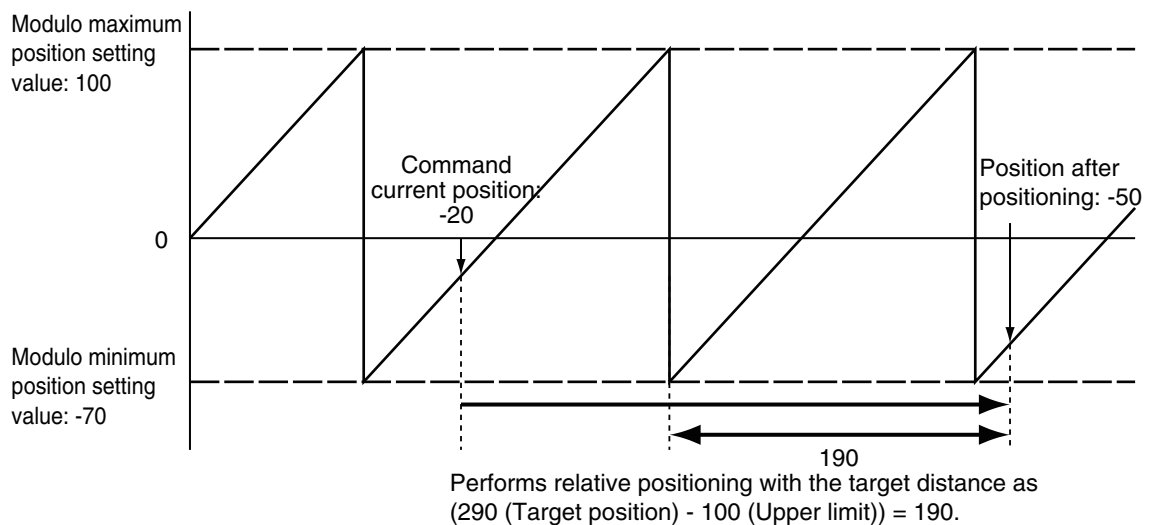

When **1: \_mcShortestWay** (Shortest way) is specified for *Direction*, positioning starts in the direction with the shortest distance between the command current position and the target position.

The following chart shows an operation example when positioning starts with a command position of 50 and moves toward -20.

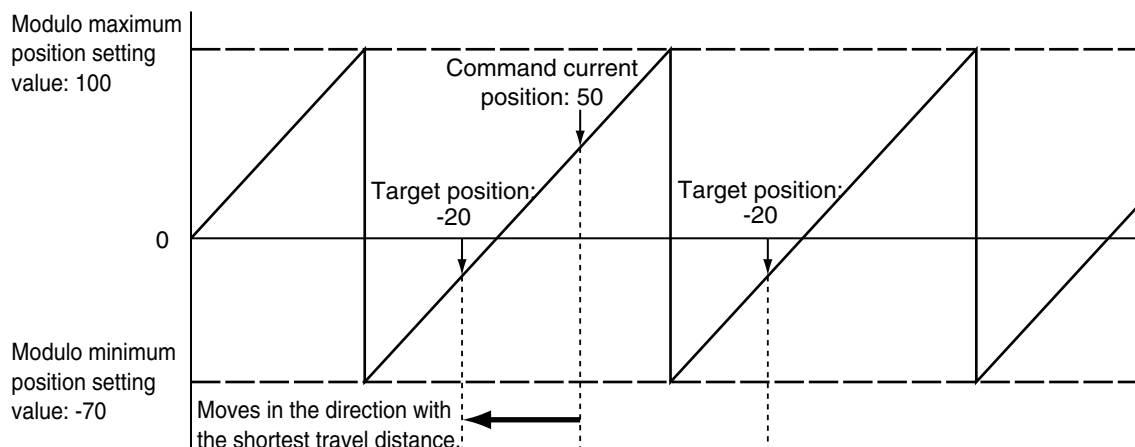

Movement is in the same direction as **3: \_mcCurrentDirection** (Current direction) if the travel distance is the same in the positive and the negative direction.



### Precautions for Correct Use

- When you perform absolute positioning, set the target position so that it is less than the **Modulo Maximum Position Setting Value** axis parameter and greater than or equal to the **Modulo Minimum Position Setting Value** axis parameter.  
If the target position is greater than or equal to the setting of the **Modulo Maximum Position Setting Value** axis parameter or less than the setting of the **Modulo Minimum Position Setting Value** axis parameter, a Target Position Setting Out of Range error (error code 5478 hex) will occur.  
However, when **4: \_mcNoDirection** (No direction specified) is specified for *Direction*, you can specify a *Position* (Target Position) outside the range specified by the modulo maximum position and modulo minimum position setting values.
- If **3: \_mcCurrentDirection** (Current direction) is specified for *Direction*, operation is in the same command direction as the previous motion. Therefore, depending on the instructions that are used together, the direction may not be the same as the direction that was specified with the input to the motion control instruction for the previous motion.  
When you specify **3: \_mcCurrentDirection**, check the current direction with *Dir.Posi* (Positive Direction) and *Dir.Nega* (Negative Direction) in the Axis Variable.

### ● In-position Check

An in-position check is performed for this instruction according to the settings in **In-position Range** and **In-position Check Time** axis parameters.

## Timing Charts

- Busy* (Executing) changes to TRUE at the same time as *Execute* changes to TRUE. *Active* (Controlling) changes to TRUE in the next period.
- Done* changes to TRUE when *Position* (Target Position) is reached and positioning is completed.
- If another instruction aborts this instruction, *CommandAborted* changes to TRUE and *Busy* (Executing) and *Active* (Controlling) change to FALSE.

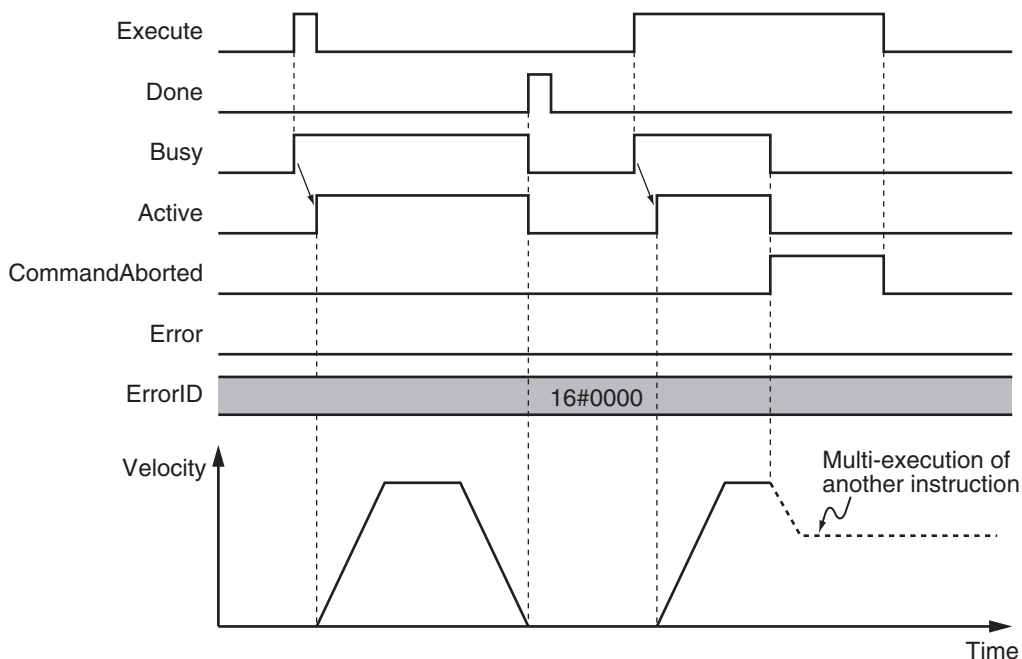

## Re-execution of Motion Control Instructions

You can change the operation of the instruction if you change an input variable during positioning and change *Execute* to TRUE again.

Input variables *Position* (Target Position), *Velocity* (Target Velocity), *Acceleration* (Acceleration Rate), and *Deceleration* (Deceleration Rate) can be changed by re-executing the motion control instruction.

For details on re-execution of motion control instructions, refer to the *NJ/NX-series CPU Unit Motion Control User's Manual (Cat. No. W507)*.

## Multi-execution of Motion Control Instructions

For details on multi-execution of motion control instructions, refer to the *NJ/NX-series CPU Unit Motion Control User's Manual (Cat. No. W507)*.

### ● Execution during Execution of Other Instructions

You can switch to this instruction or buffer this instruction if you execute it during execution of another instruction.

You can buffer one instruction per axis.

Specify the operation of this instruction with *BufferMode* (Buffer Mode Selection) for multi-execution of instructions.

Buffer Mode Selection	Description
Aborting	Aborts the instruction being executed and switches to this instruction. If the direction of axis motion is reversed by switching instructions, the motion will be reversed according to the <b>Operation Selection at Reversing</b> axis parameter.
Buffered	Buffers this instruction and executes it automatically after the current instruction is completed.
Blending	Starts the buffered instruction at the velocity (transit velocity) at which the current instruction reaches the target position. The operation of the current instruction is changed so that the axes reach the target position at the transit velocity. There are four methods to specify the transit velocity. These are described below.
Blending low	The lower of the target velocities of the current instruction and the buffered instruction is used as the transit velocity.
Blending previous	The target velocity of the current instruction is used as the transit velocity.
Blending next	The target velocity of the buffered instruction is used as the transit velocity.
Blending high	The higher of the target velocities of the current instruction and the buffered instruction is used as the transit velocity.

For details on *BufferMode* (Buffer Mode Selection), refer to the *NJ/NX-series CPU Unit Motion Control User's Manual (Cat. No. W507)*.

### ● Execution of Other Instructions during Instruction Execution

If you execute another instruction during execution of this instruction, you can specify **Aborting**, **Buffered**, or **Blending**.

## Errors

If an error occurs during instruction execution, *Error* will change to TRUE.

You can find out the cause of the error by referring to the value output by *ErrorID* (Error Code).

### ● Timing Chart When Error Occurs

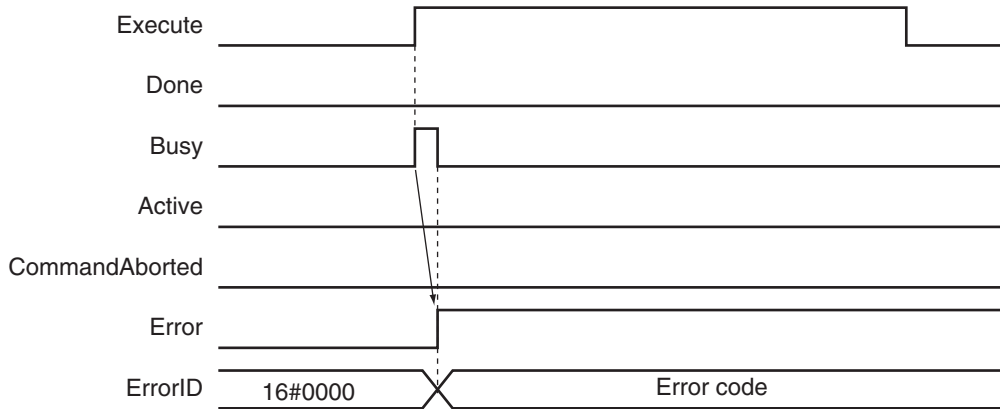

### ● Error Codes

Refer to the *NJ/NX-series Troubleshooting Manual (Cat. No. W503)* for instruction errors.

## Sample Programming 1

This section shows sample programming for positioning by periodic multi-execution of instructions.

## Parameter Settings

The minimum settings required for this sample programming are given below.

### ● Setting Axis Parameters

#### Axis Type

Axis	Axis Type
Axis 1	Servo axis

#### Count Mode

Axis	Count Mode
Axis 1	Linear Mode

#### Unit of Display

Axis	Unit of Display
Axis 1	mm

## Operation Example

In this sample, *BufferMode* (Buffer Mode Selection) is set to **Buffered** for MC\_MoveAbsolute (Absolute Positioning) instructions and the axis is moved to the final target position by executing multiple instructions.

When the axis reaches the final target position, it is returned to home with the MC\_ZeroPosition (High-speed Home) instruction.

Multi-execution of instructions is performed when the *Active* (Controlling) output variable from the previous instruction is TRUE. For single-axis operation, multi-execution is possible for only one instruction.

### ● Operation Pattern

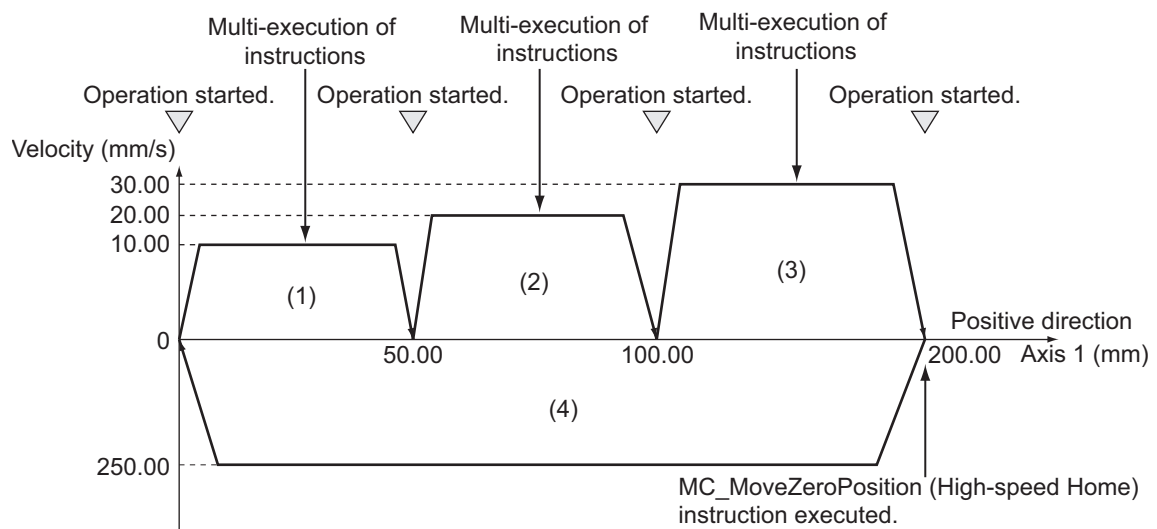

- 1** Turning ON the Operation Start Switch  
When you turn ON the operation start switch at home, axis 1 is positioned to 50.00 mm in the positive direction.
- 2** Turning ON the Operation Start Switch Again  
Thereafter, axis 1 is positioned to 100.00 mm and 200.00 mm, and then returns to home and stops. The operation start switch must be turned ON once for each of these motions.

## Ladder Diagram

### ● Main Variables

Name	Data type	Default	Comment
MC_Axis000	_sAXIS_REF	---	Axis Variable for axis 1.
MC_Axis000.MFaultLvl.Active	BOOL	FALSE	TRUE while there is a minor fault level error for axis 1.
MC_Axis000.Details.Homed	BOOL	FALSE	TRUE when home is defined for axis 1.

Name	Data type	Default	Comment
Pwr_Status	BOOL	FALSE	This variable is assigned to the <i>Status</i> output variable from the PWR instance of the MC_Power instruction. This variable changes to TRUE when the Servo is turned ON.
StartPg	BOOL	FALSE	The Servo is turned ON if this variable is TRUE and EtherCAT process data communications are established.

#### ● Timing Chart

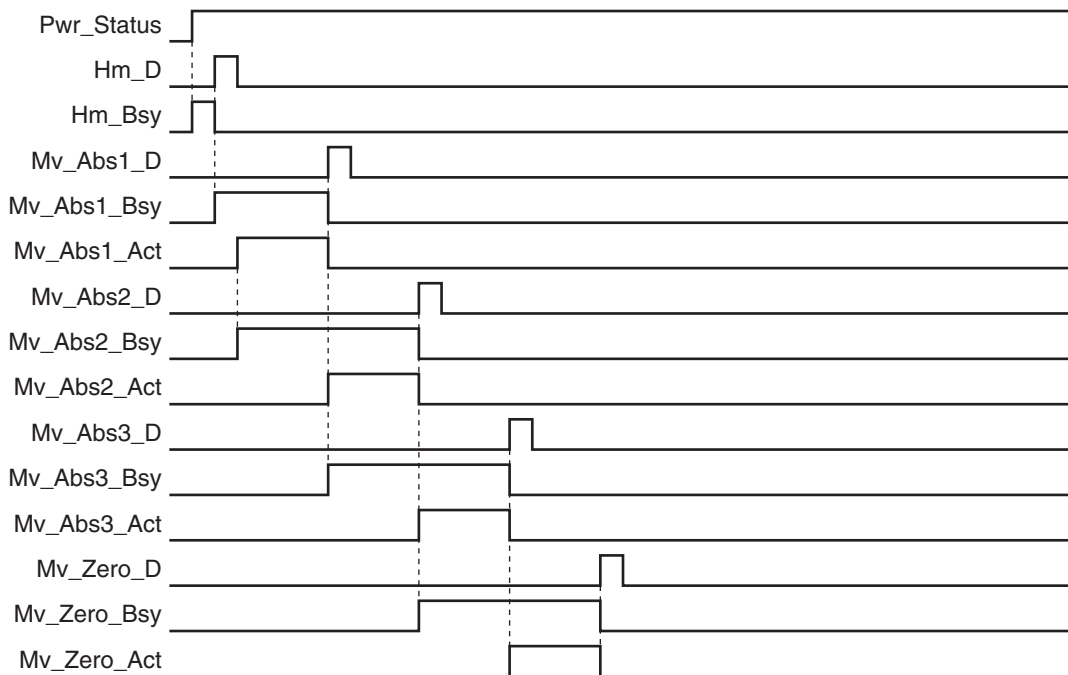

#### ● Sample Programming

If *StartPg* is TRUE, check that the Servo Drive is ready.

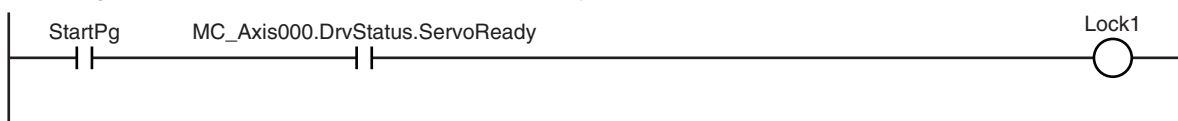

If the Servo Drive is ready, the Servo is turned ON.

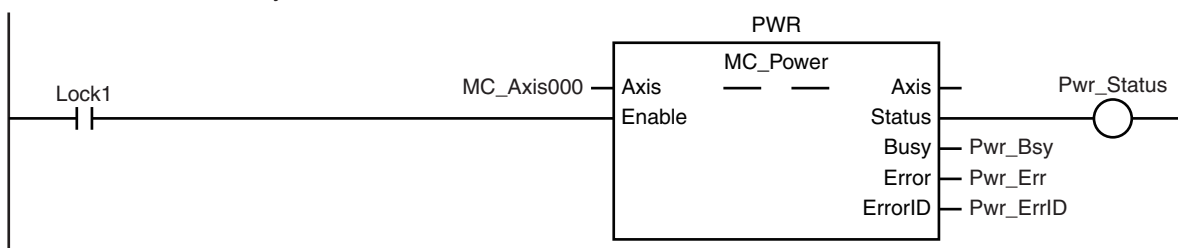

If a minor fault level error occurs for axis 1, the error handler for the device (FaultHandler) is executed. Program the FaultHandler according to the device.

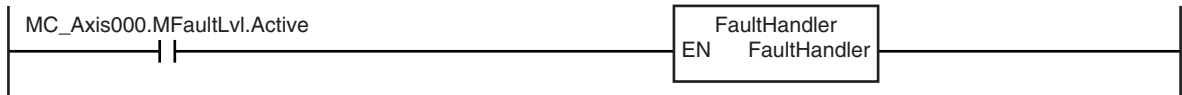

If the Servo is ON and home is not defined, the Home instruction is executed.

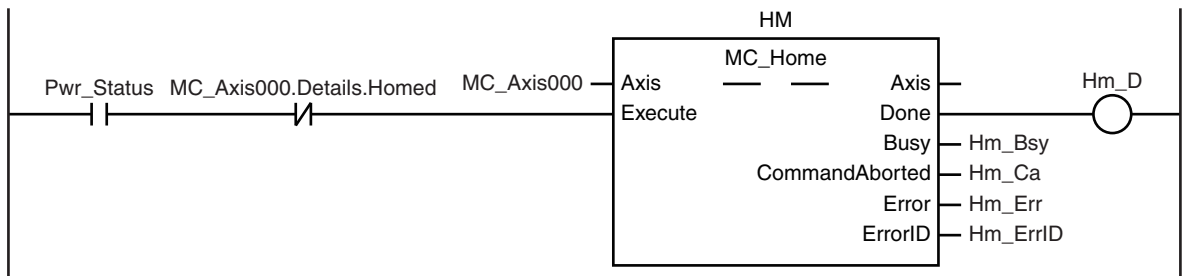

After home is defined, absolute positioning 1 is started.

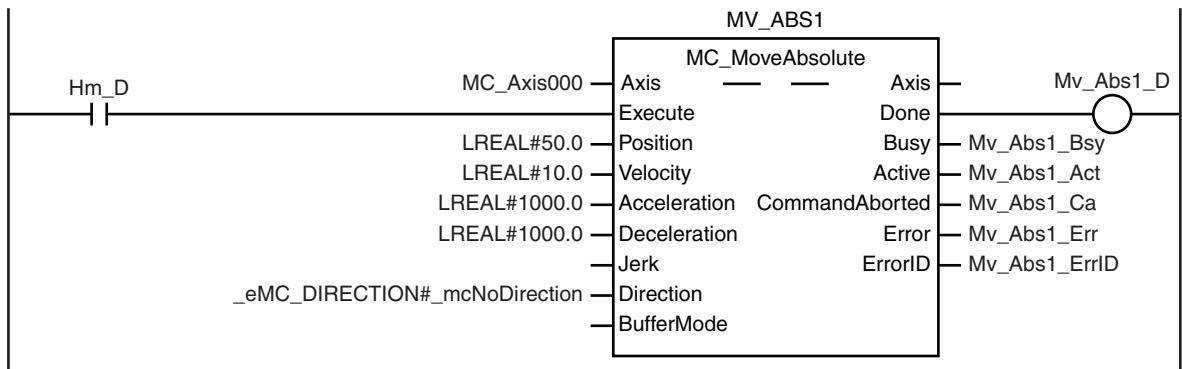

After absolute positioning 1 is started, absolute positioning 2 is started with multi-execution of instructions.

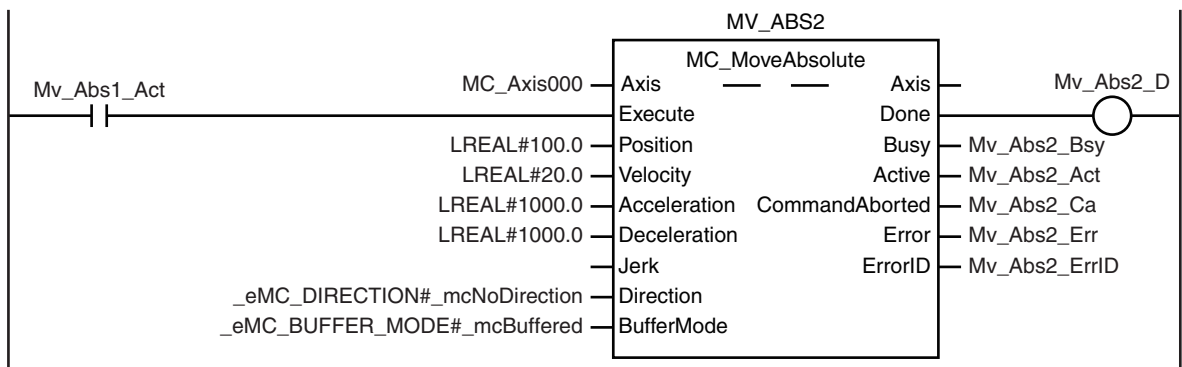

After absolute positioning 2 is started, absolute positioning 3 is started with multi-execution of instructions.

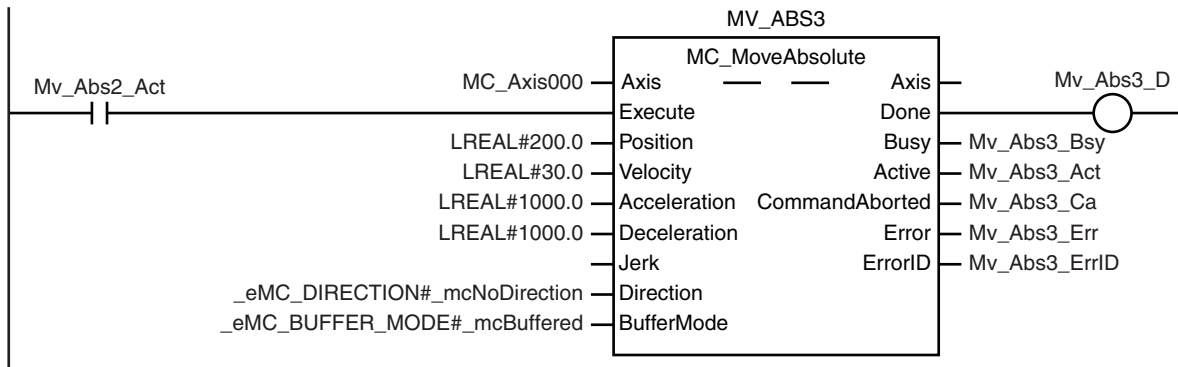

After absolute positioning 3 is started, the MC\_MoveZeroPosition (High-speed Home) instruction is executed.

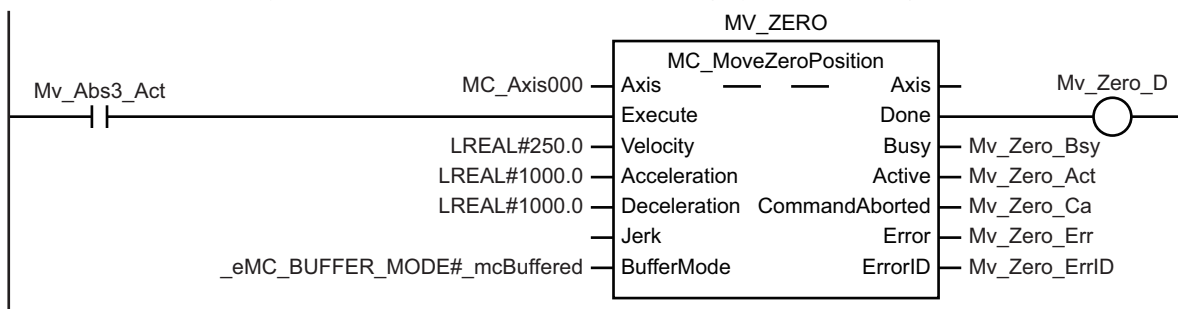

## Structured Text (ST)

### ● Main Variables

Name	Data type	Default	Comment
MC_Axis000	_sAXIS_REF	---	Axis Variable for axis 1.
MC_Axis000.MFaultLvl.Active	BOOL	FALSE	TRUE while there is a minor fault level error for axis 1.
MC_Axis000.Details.Homed	BOOL	FALSE	TRUE when home is defined for axis 1.
Pwr_Status	BOOL	FALSE	This variable is assigned to the <i>Status</i> output variable from the PWR instance of the MC_Power instruction. This variable changes to TRUE when the Servo is turned ON.
StartPg	BOOL	FALSE	The Servo is turned ON if this variable is TRUE and EtherCAT process data communications are established.
Hm_Ex	BOOL	FALSE	The HM instance of MC_Home is executed when this variable changes to TRUE.
Mv_Abs1_Ex	BOOL	FALSE	The MV_ABS1 instance of MC_MoveAbsolute is executed when this variable changes to TRUE.
Mv_Abs2_Ex	BOOL	FALSE	The MV_ABS2 instance of MC_MoveAbsolute is executed when this variable changes to TRUE.
Mv_Abs3_Ex	BOOL	FALSE	The MV_ABS3 instance of MC_MoveAbsolute is executed when this variable changes to TRUE.



Name	Data type	Default	Comment
Mv_Zero_Ex	BOOL	FALSE	The MV_ZERO instance of MC_MoveZeroPosition is executed when this variable changes to TRUE.
InitFlag	BOOL	FALSE	This variable indicates if it is necessary to set the input parameters. Input parameters are set when this variable is FALSE. When setting the input parameters is completed, this variable changes to TRUE.

### ● Timing Chart

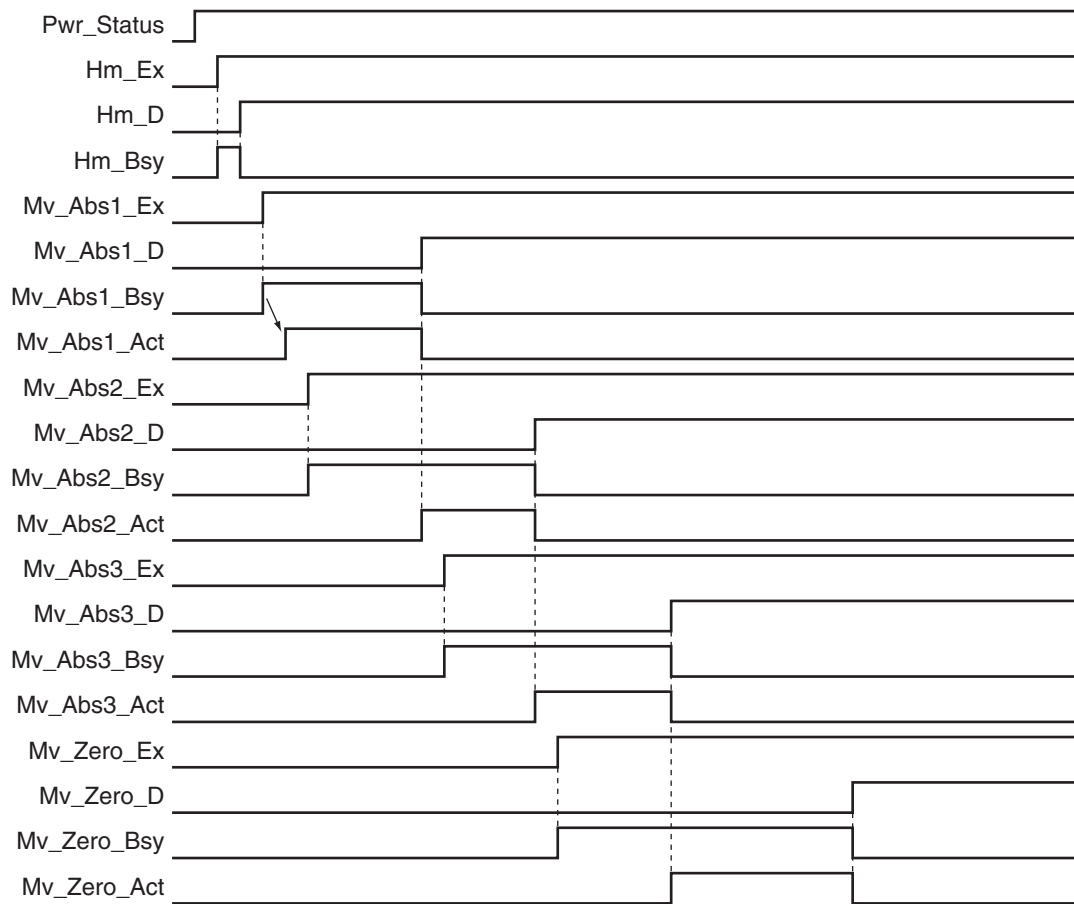

### ● Sample Programming

```
// Processing when input parameters are not set
IF InitFlag = FALSE THEN

    // MV_ABS1 parameters
    Mv_Abs1_Pos := LREAL#50.0;
    Mv_Abs1_Vel := LREAL#10.0;
    Mv_Abs1_Acc := LREAL#1000.0;
    Mv_Abs1_Dec := LREAL#1000.0;
    Mv_Abs1_Dir := _eMC_DIRECTION#_mcNoDirection;

    // MV_ABS2 parameters
```

```

Mv_Abs2_Pos := LREAL#100.0;
Mv_Abs2_Vel := LREAL#20.0;
Mv_Abs2_Acc := LREAL#1000.0;
Mv_Abs2_Dec := LREAL#1000.0;
Mv_Abs2_Dir := _eMC_DIRECTION#_mcNoDirection;
Mv_Abs2_Bm := _eMC_BUFFER_MODE#_mcBuffered;

// MV_ABS3 parameters
Mv_Abs3_Pos := LREAL#200.0;
Mv_Abs3_Vel := LREAL#30.0;
Mv_Abs3_Acc := LREAL#1000.0;
Mv_Abs3_Dec := LREAL#1000.0;
Mv_Abs3_Dir := _eMC_DIRECTION#_mcNoDirection;
Mv_Abs3_Bm := _eMC_BUFFER_MODE#_mcBuffered;

// MV_ZERO parameters
Mv_Zero_Vel := LREAL#250;
Mv_Zero_Acc := LREAL#1000.0;
Mv_Zero_Dec := LREAL#1000.0;
Mv_Zero_Bm := _eMC_BUFFER_MODE#_mcBuffered;

// Change InitFlag to TRUE after setting the input parameters.
InitFlag:=TRUE;

END_IF;

// If StartPg is TRUE and the Servo Drive is ready, the Servo is turned ON.
// If the Servo Drive is not ready, the Servo is turned OFF.
IF (StartPg=TRUE)
AND (MC_Axis000.DrvStatus.Ready=TRUE) THEN
    Pwr_En:=TRUE;
ELSE
    Pwr_En:=FALSE;
END_IF;

// Processing for a minor fault level error
// Program the FaultHandler according to the device.
IF MC_Axis000.MFaultLvl.Active=TRUE THEN
    FaultHandler();
END_IF;

// If the Servo is ON and home is not defined, the Home instruction is executed.
IF (Pwr_Status=TRUE) AND (MC_Axis000.Details.Homed=FALSE) THEN
    Hm_Ex:=TRUE;
END_IF;

// After home is defined, MV_ABS1 is executed.

```

```

IF Hm_D=TRUE THEN
    Mv_Abs1_Ex:=TRUE;
END_IF;

// After MV_ABS1 is started, MV_ABS2 is executed with multi-execution of instructions.
IF Mv_Abs1_Act=TRUE THEN
    Mv_Abs2_Ex:=TRUE;
END_IF;

// After MV_ABS2 is started, MV_ABS3 is executed with multi-execution of instructions.
IF Mv_Abs2_Act=TRUE THEN
    Mv_Abs3_Ex:=TRUE;
END_IF;

// After MV_ABS3 is started, MV_ZERO is executed with multi-execution of instructions.
IF Mv_Abs3_Act=TRUE THEN
    Mv_Zero_Ex:=TRUE;
END_IF;

// MC_Power
PWR(
    Axis := MC_Axis000,
    Enable := Pwr_En,
    Status => Pwr_Status,
    Busy => Pwr_Bsy,
    Error => Pwr_Err,
    ErrorID => Pwr_ErrID
);

// MC_Home
HM(
    Axis := MC_Axis000,
    Execute := Hm_Ex,
    Done => Hm_D,
    Busy => Hm_Bsy,
    CommandAborted => Hm_Ca,
    Error => Hm_Err,
    ErrorID => Hm_ErrID
);

// MC_MoveAbsolute
MV_ABS1(
    Axis := MC_Axis000,
    Execute := Mv_Abs1_Ex,

```

```
    Position := Mv_Abs1_Pos,  
    Velocity := Mv_Abs1_Vel,  
    Acceleration := Mv_Abs1_Acc,  
    Deceleration := Mv_Abs1_Dec,  
    Direction := Mv_Abs1_Dir,  
    Done => Mv_Abs1_D,  
    Busy => Mv_Abs1_Bsy,  
    Active => Mv_Abs1_Act,  
    CommandAborted => Mv_Abs1_Ca,  
    Error => Mv_Abs1_Err,  
    ErrorID => Mv_Abs1_ErrID  
);
```

```
MV_ABS2(  
    Axis := MC_Axis000,  
    Execute := Mv_Abs2_Ex,  
    Position := Mv_Abs2_Pos,  
    Velocity := Mv_Abs2_Vel,  
    Acceleration := Mv_Abs2_Acc,  
    Deceleration := Mv_Abs2_Dec,  
    Direction := Mv_Abs2_Dir,  
    BufferMode := Mv_Abs2_Bm,  
    Done => Mv_Abs2_D,  
    Busy => Mv_Abs2_Bsy,  
    Active => Mv_Abs2_Act,  
    CommandAborted => Mv_Abs2_Ca,  
    Error => Mv_Abs2_Err,  
    ErrorID => Mv_Abs2_ErrID  
);
```

```
MV_ABS3(  
    Axis := MC_Axis000,  
    Execute := Mv_Abs3_Ex,  
    Position := Mv_Abs3_Pos,  
    Velocity := Mv_Abs3_Vel,  
    Acceleration := Mv_Abs3_Acc,  
    Deceleration := Mv_Abs3_Dec,  
    Direction := Mv_Abs3_Dir,  
    BufferMode := Mv_Abs3_Bm,  
    Done => Mv_Abs3_D,  
    Busy => Mv_Abs3_Bsy,  
    Active => Mv_Abs3_Act,  
    CommandAborted => Mv_Abs3_Ca,  
    Error => Mv_Abs3_Err,  
    ErrorID => Mv_Abs3_ErrID  
);
```

```

// MC_MoveZeroPosition
MV_ZERO (
    Axis := MC_Axis000,
    Execute := Mv_Zero_Ex,
    Velocity := Mv_Zero_Vel,
    Acceleration := Mv_Zero_Acc,
    Deceleration := Mv_Zero_Dec,
    BufferMode := Mv_Zero_Bm,
    Done => Mv_Zero_D,
    Busy => Mv_Zero_Bsy,
    Active => Mv_Zero_Act,
    CommandAborted => Mv_Zero_Ca,
    Error => Mv_Zero_Err,
    ErrorID => Mv_Zero_ErrID
);

```

## Sample Programming 2

In this sample, when the Count Mode is set to Rotary Mode and positioning is performed toward the target position, the shortest direction, clockwise or counterclockwise, is automatically determined and positioning is performed.

This section shows sample programming for shortest-way control of the rotation direction of a tool changer.

## Parameter Settings

The minimum settings required for this sample programming are given below.

### ● Setting Axis Parameters

#### Axis Type

Axis	Axis Type
Axis 1	Servo axis

#### Count Mode

Axis	Count Mode
Axis 1	Rotary Mode

#### Ring Counter

Axis	Modulo maximum position	Modulo minimum position
Axis 1	360	0

#### Unit of Display

Axis	Unit of Display
Axis 1	degree

## Operation Example

In this sample, multi-execution of absolute positioning instructions is used to position in a range of 0° to 360°. The actual position returns to 0° once it exceeds the range of 0° to 360°.

Multi-execution of instructions is performed when the *Active* (Controlling) output variable from the previous instruction is TRUE. For single-axis operation, multi-execution is possible for only one instruction.

In this sample, multi-execution of instructions is executed with *BufferMode* (Buffer Mode Selection) set to **Buffered**.

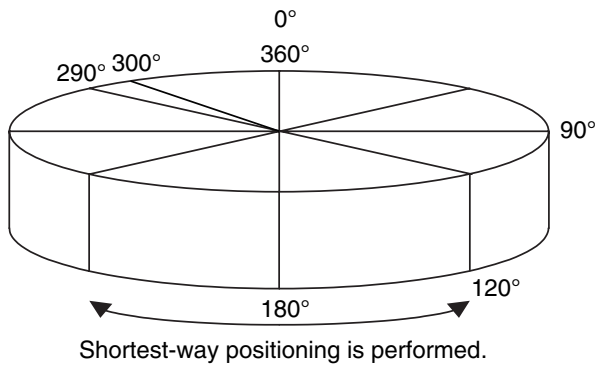

If you specify 0° (home), 90°, 120°, or 290°, the axis will move to that position.

The rotation direction in this instance is in the shorter rotation direction. The travel velocity is 250°/s.

The sample programming performs positioning with a shortest way specification from 290° to 90° to 120° and then to home (0°).

## Ladder Diagram

### ● Main Variables

Name	Data type	Default	Comment
MC_Axis000	_sAXIS_REF	---	Axis Variable for axis 1.
MC_Axis000.MFaultLvl.Active	BOOL	FALSE	TRUE while there is a minor fault level error for axis 1.
MC_Axis000.Details.Homed	BOOL	FALSE	TRUE when home is defined for axis 1.
Pwr_Status	BOOL	FALSE	This variable is assigned to the <i>Status</i> output variable from the PWR instance of the MC_Power instruction. This variable changes to TRUE when the Servo is turned ON.
StartPg	BOOL	FALSE	The Servo is turned ON if this variable is TRUE and EtherCAT process data communications are established.

● **Timing Chart**

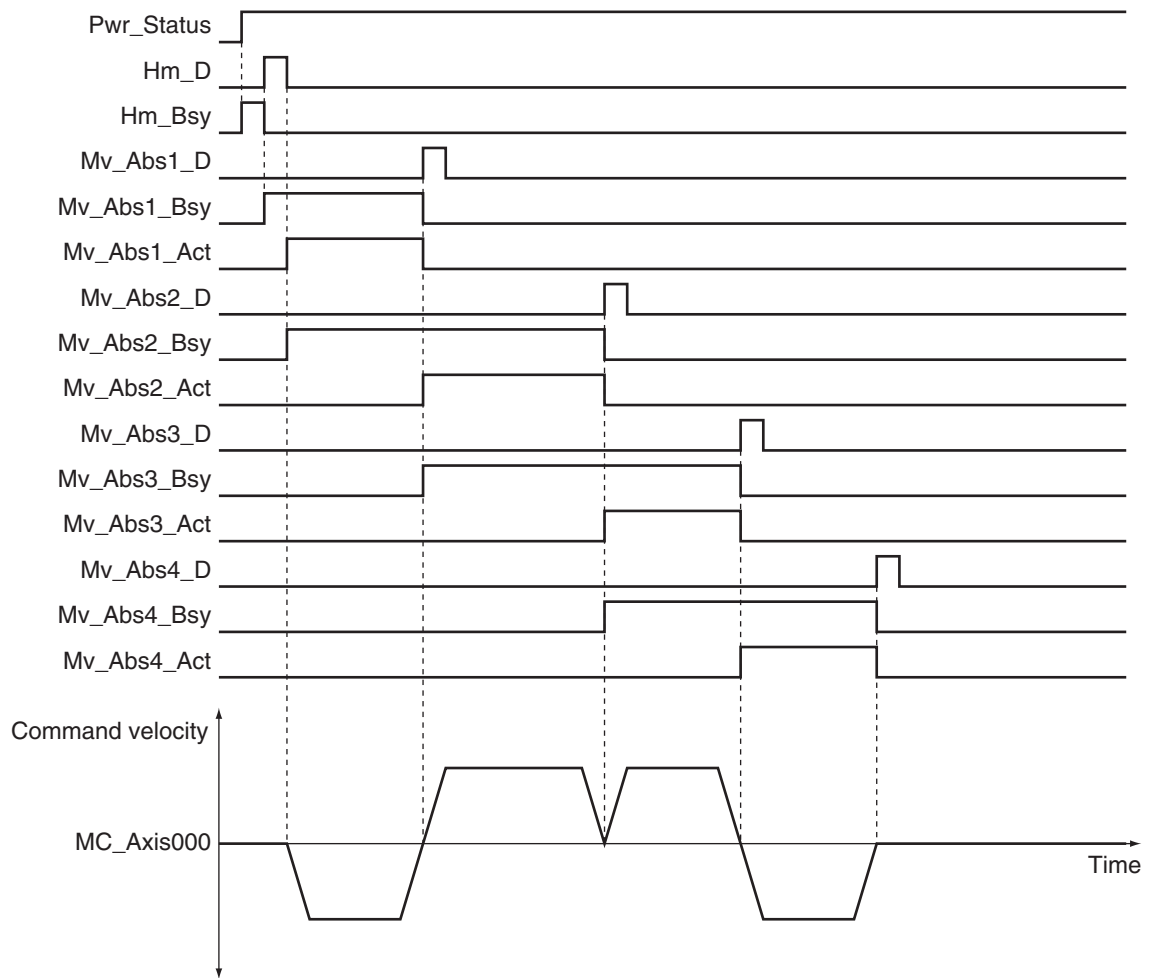

● **Sample Programming**

If *StartPg* is TRUE, check that the Servo Drive is ready.

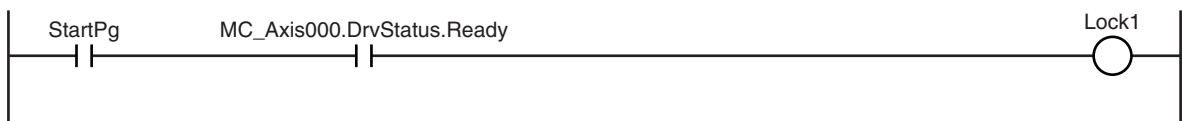

If the Servo Drive is ready, the Servo is turned ON.

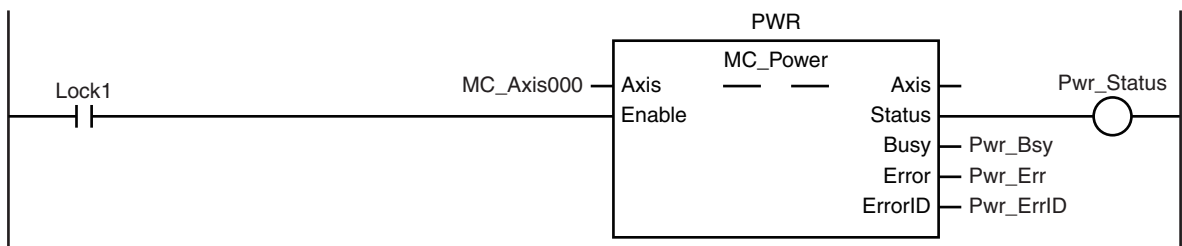

If a minor fault level error occurs for axis 1, the error handler for the device (FaultHandler) is executed. Program the FaultHandler according to the device.

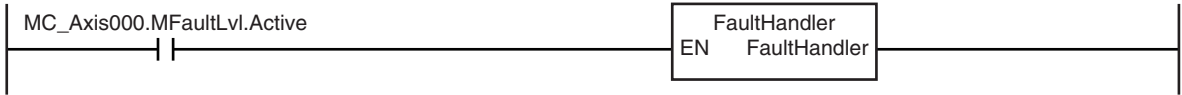

If the Servo is ON and home is not defined, the Home instruction is executed.

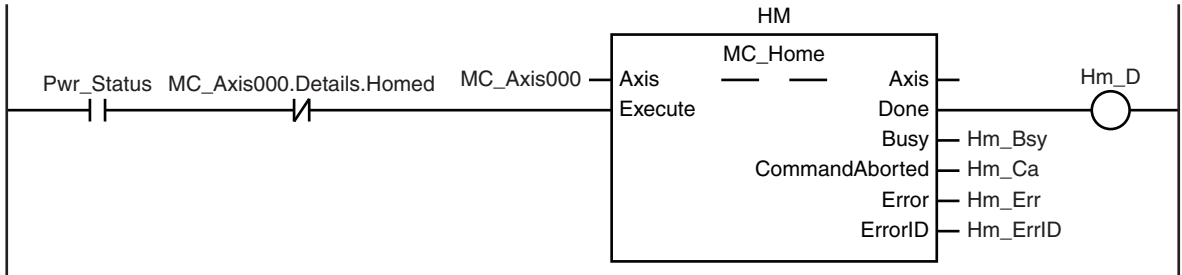

After home is defined, absolute positioning 1 is executed to move to 290.0°. The shortest way is specified for the motion direction.

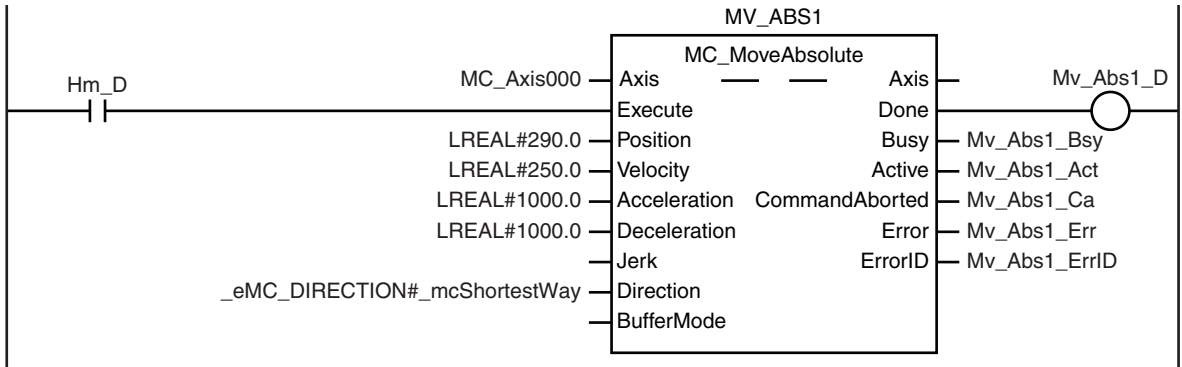

Absolute positioning 2 is executed with multi-execution of instructions to move from 290.0° to 90.0°. The shortest way is used for the motion direction.

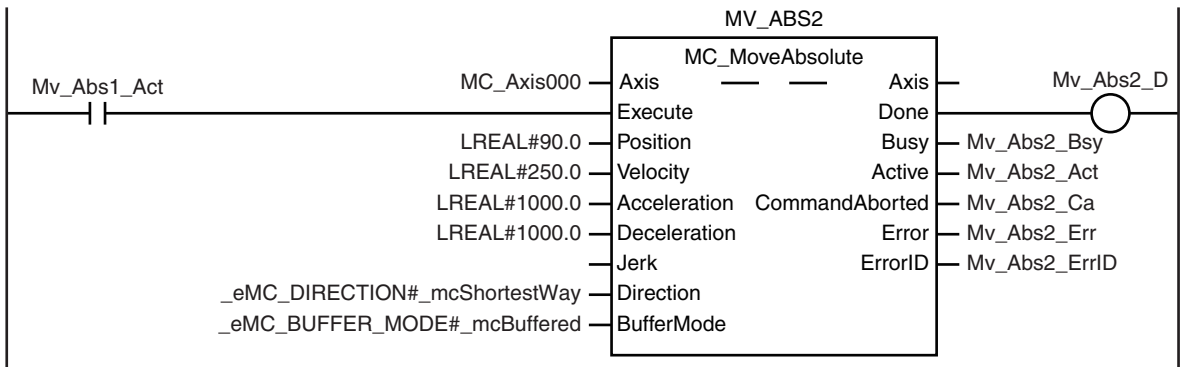



Absolute positioning 3 is executed with multi-execution of instructions to move from 90.0° to 120.0°. The shortest way is used for the motion direction.

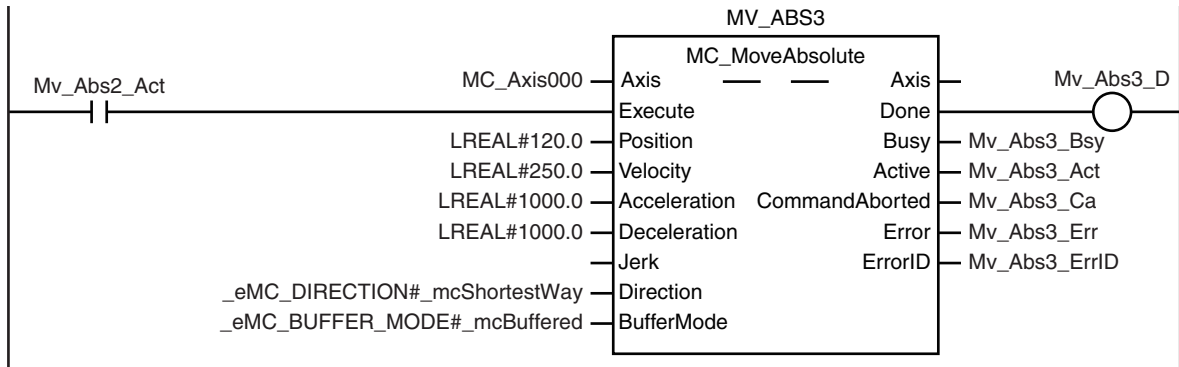

Absolute positioning 4 is executed with multi-execution of instructions to move from 120.0° to 0.0°. The shortest way is used for the motion direction.

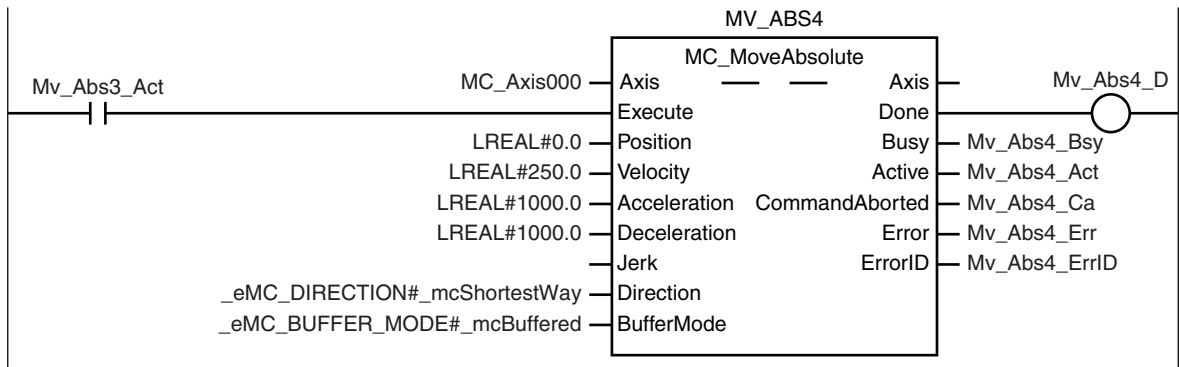

## Structured Text (ST)

### ● Main Variables

Name	Data type	Default	Comment
MC_Axis000	_sAXIS_REF	---	Axis Variable for axis 1.
MC_Axis000.MFaultLvl.Active	BOOL	FALSE	TRUE while there is a minor fault level error for axis 1.
MC_Axis000.Details.Homed	BOOL	FALSE	TRUE when home is defined for axis 1.
Pwr_Status	BOOL	FALSE	This variable is assigned to the <i>Status</i> output variable from the PWR instance of the MC_Power instruction. This variable changes to TRUE when the Servo is turned ON.
StartPg	BOOL	FALSE	The Servo is turned ON if this variable is TRUE and EtherCAT process data communications are established.
Hm_Ex	BOOL	FALSE	The HM instance of MC_Home is executed when this variable changes to TRUE.
Mv_Abs1_Ex	BOOL	FALSE	The MV_ABS1 instance of MC_MoveAbsolute is executed when this variable changes to TRUE.
Mv_Abs2_Ex	BOOL	FALSE	The MV_ABS2 instance of MC_MoveAbsolute is executed when this variable changes to TRUE.

Name	Data type	Default	Comment
Mv_Abs3_Ex	BOOL	FALSE	The MV_ABS3 instance of MC_MoveAbsolute is executed when this variable changes to TRUE.
Mv_Abs4_Ex	BOOL	FALSE	The MV_ABS4 instance of MC_MoveAbsolute is executed when this variable changes to TRUE.
InitFlag	BOOL	FALSE	This variable indicates if it is necessary to set the input parameters. Input parameters are set when this variable is FALSE. When setting the input parameters is completed, this variable changes to TRUE.

#### ● Timing Chart

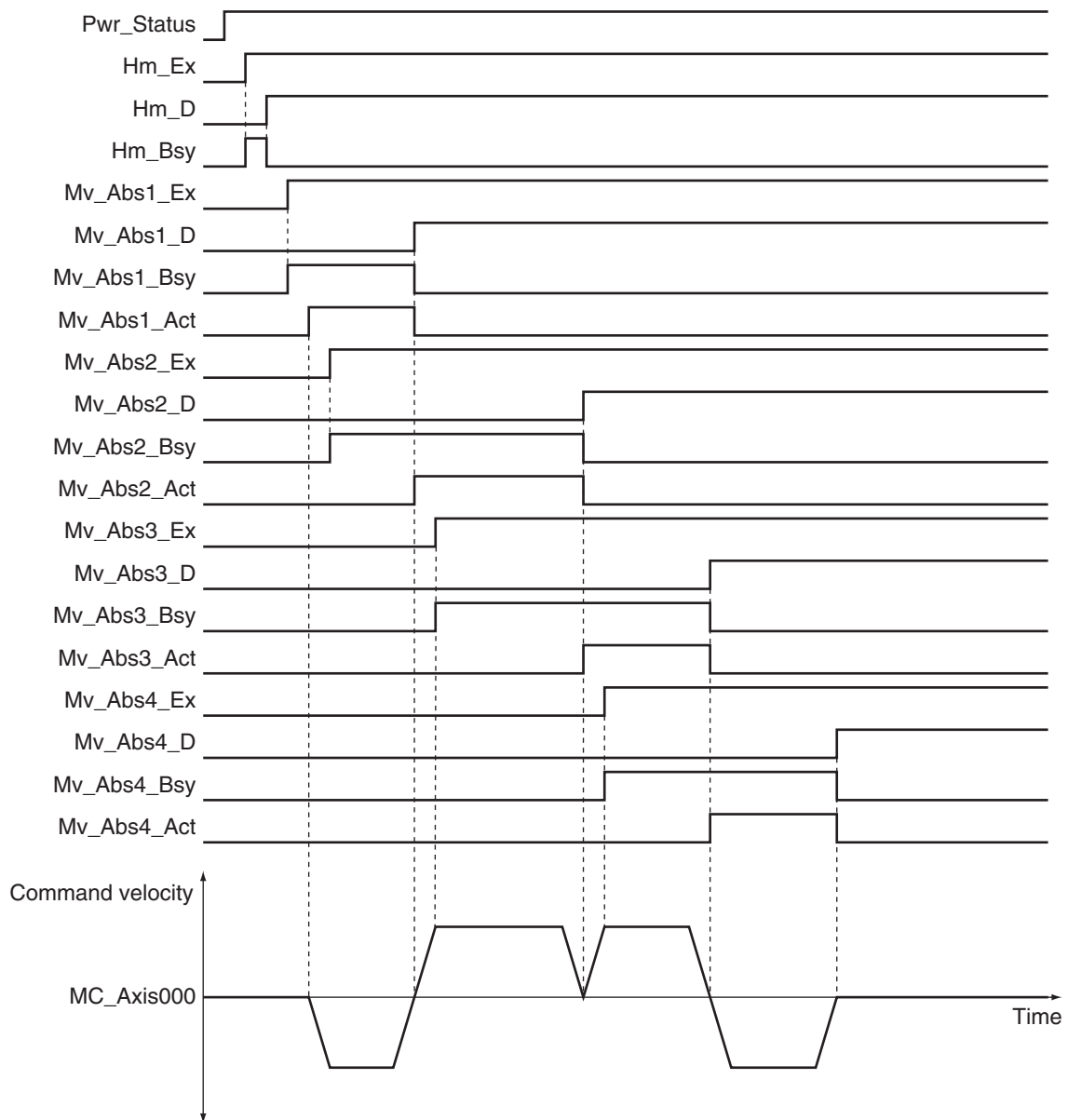

#### ● Sample Programming

```
// Processing when input parameters are not set
IF InitFlag = FALSE THEN
```

```

// MV_ABS1 parameters
Mv_Abs1_Pos := LREAL#290.0;
Mv_Abs1_Vel := LREAL#250.0;
Mv_Abs1_Acc := LREAL#1000.0;
Mv_Abs1_Dec := LREAL#1000.0;
Mv_Abs1_Dir := _eMC_DIRECTION#_mcShortestWay;

// MV_ABS2 parameters
Mv_Abs2_Pos := LREAL#90.0;
Mv_Abs2_Vel := LREAL#250.0;
Mv_Abs2_Acc := LREAL#1000.0;
Mv_Abs2_Dec := LREAL#1000.0;
Mv_Abs2_Dir := _eMC_DIRECTION#_mcShortestWay;
Mv_Abs2_Bm := _eMC_BUFFER_MODE#_mcBuffered;

// MV_ABS3 parameters
Mv_Abs3_Pos := LREAL#120.0;
Mv_Abs3_Vel := LREAL#250.0;
Mv_Abs3_Acc := LREAL#1000.0;
Mv_Abs3_Dec := LREAL#1000.0;
Mv_Abs3_Dir := _eMC_DIRECTION#_mcShortestWay;
Mv_Abs3_Bm := _eMC_BUFFER_MODE#_mcBuffered;

// MV_ABS4 parameters
Mv_Abs4_Pos := LREAL#0.0;
Mv_Abs4_Vel := LREAL#250.0;
Mv_Abs4_Acc := LREAL#1000.0;
Mv_Abs4_Dec := LREAL#1000.0;
Mv_Abs4_Dir := _eMC_DIRECTION#_mcShortestWay;
Mv_Abs4_Bm := _eMC_BUFFER_MODE#_mcBuffered;

// Change InitFlag to TRUE after setting the input parameters.
InitFlag := TRUE;

END_IF;

// If StartPg is TRUE and the Servo Drive is ready, the Servo is turned ON.
// If the Servo Drive is not ready, the Servo is turned OFF.
IF (StartPg=TRUE)
AND (MC_Axis000.DrvStatus.Ready=TRUE) THEN
    Pwr_En:=TRUE;
ELSE
    Pwr_En:=FALSE;
END_IF;

// Processing for a minor fault level error

```

```
// Program the FaultHandler according to the device.
IF MC_Axis000.MFaultLvl.Active=TRUE THEN
    FaultHandler();
END_IF;

// If the Servo is ON and home is not defined, the Home instruction is executed.
IF (Pwr_Status=TRUE) AND (MC_Axis000.Details.Homed=FALSE) THEN
    Hm_Ex:=TRUE;
END_IF;

// After home is defined, MV_ABS1 is executed.
IF Hm_D=TRUE THEN
    Mv_Abs1_Ex:=TRUE;
END_IF;

// After MV_ABS1 is started, MV_ABS2 is executed with multi-execution of instructions.
IF Mv_Abs1_Act=TRUE THEN
    Mv_Abs2_Ex:=TRUE;
END_IF;

// After MV_ABS2 is started, MV_ABS3 is executed with multi-execution of instructions.
IF Mv_Abs2_Act=TRUE THEN
    Mv_Abs3_Ex:=TRUE;
END_IF;

// After MV_ABS3 is started, MV_ABS4 is executed with multi-execution of instructions.
IF Mv_Abs3_Act=TRUE THEN
    Mv_Abs4_Ex:=TRUE;
END_IF;

// MC_Power
PWR(
    Axis := MC_Axis000,
    Enable := Pwr_En,
    Status => Pwr_Status,
    Busy => Pwr_Bsy,
    Error => Pwr_Err,
    ErrorID => Pwr_ErrID
);

// MC_Home
HM(
    Axis := MC_Axis000,
    Execute := Hm_Ex,
```

```

    Done => Hm_D,
    Busy => Hm_Bsy,
    CommandAborted => Hm_Ca,
    Error => Hm_Err,
    ErrorID => Hm_ErrID
);

// Absolute positioning (1)
MV_ABS1(
    Axis := MC_Axis000,
    Execute := Mv_Abs1_Ex,
    Position := Mv_Abs1_Pos,
    Velocity := Mv_Abs1_Vel,
    Acceleration := Mv_Abs1_Acc,
    Deceleration := Mv_Abs1_Dec,
    Direction := Mv_Abs1_Dir,
    Done => Mv_Abs1_D,
    Busy => Mv_Abs1_Bsy,
    Active => Mv_Abs1_Act,
    CommandAborted => Mv_Abs1_Ca,
    Error => Mv_Abs1_Err,
    ErrorID => Mv_Abs1_ErrID
);

// Absolute positioning (2)
MV_ABS2(
    Axis := MC_Axis000,
    Execute := Mv_Abs2_Ex,
    Position := Mv_Abs2_Pos,
    Velocity := Mv_Abs2_Vel,
    Acceleration := Mv_Abs2_Acc,
    Deceleration := Mv_Abs2_Dec,
    Direction := Mv_Abs2_Dir,
    BufferMode := Mv_Abs2_Bm,
    Done => Mv_Abs2_D,
    Busy => Mv_Abs2_Bsy,
    Active => Mv_Abs2_Act,
    CommandAborted => Mv_Abs2_Ca,
    Error => Mv_Abs2_Err,
    ErrorID => Mv_Abs2_ErrID
);

// Absolute positioning (3)
MV_ABS3(
    Axis := MC_Axis000,
    Execute := Mv_Abs3_Ex,
    Position := Mv_Abs3_Pos,

```

```
Velocity := Mv_Abs3_Vel,  
Acceleration := Mv_Abs3_Acc,  
Deceleration := Mv_Abs3_Dec,  
Direction := Mv_Abs3_Dir,  
BufferMode := Mv_Abs3_Bm,  
Done => Mv_Abs3_D,  
Busy => Mv_Abs3_Bsy,  
Active => Mv_Abs3_Act,  
CommandAborted => Mv_Abs3_Ca,  
Error => Mv_Abs3_Err,  
ErrorID => Mv_Abs3_ErrID  
);  
  
// Absolute positioning (4)  
MV_ABS4(  
  Axis := MC_Axis000,  
  Execute := Mv_Abs4_Ex,  
  Position := Mv_Abs4_Pos,  
  Velocity := Mv_Abs4_Vel,  
  Acceleration := Mv_Abs4_Acc,  
  Deceleration := Mv_Abs4_Dec,  
  Direction := Mv_Abs4_Dir,  
  BufferMode := Mv_Abs4_Bm,  
  Done => Mv_Abs4_D,  
  Busy => Mv_Abs4_Bsy,  
  Active => Mv_Abs4_Act,  
  CommandAborted => Mv_Abs4_Ca,  
  Error => Mv_Abs4_Err,  
  ErrorID => Mv_Abs4_ErrID  
);
```

# MC\_MoveRelative

The MC\_MoveRelative instruction moves the axis the specified travel distance from the command current position.

Instruction	Name	FB/ FUN	Graphic expression	ST expression
MC_MoveRelative	Relative Positioning	FB		<pre>MC_MoveRelative_instance (   Axis :=parameter,   Execute :=parameter,   Distance :=parameter,   Velocity :=parameter,   Acceleration :=parameter,   Deceleration :=parameter,   Jerk :=parameter,   BufferMode :=parameter,   Done =&gt;parameter,   Busy =&gt;parameter,   Active =&gt;parameter,   CommandAborted =&gt;parameter,   Error =&gt;parameter,   ErrorID =&gt;parameter );</pre>

## Variables

### Input Variables

Name	Meaning	Data type	Valid range	Default	Description
Execute	Execute	BOOL	TRUE or FALSE	FALSE	The instruction is executed when the value of this variable changes to TRUE.
Distance	Travel Distance	LREAL	Negative number, positive number, or 0	0	Specify the travel distance from the command current position. The unit is command units.*1
Velocity	Target Velocity	LREAL	Positive number	0	Specify the target velocity.*2 The unit is command units/s.*1
Acceleration	Acceleration Rate	LREAL	Non-negative number	0	Specify the acceleration rate. The unit is command units/s <sup>2</sup> .*1
Deceleration	Deceleration Rate	LREAL	Non-negative number	0	Specify the deceleration rate. The unit is command units/s <sup>2</sup> .*1
Jerk	Jerk	LREAL	Non-negative number	0	Specify the jerk. The unit is command units/s <sup>3</sup> .*1

Name	Meaning	Data type	Valid range	Default	Description
BufferMode	Buffer Mode Selection	_eMC_BUF-FER_MODE	0: _mcAborting 1: _mcBuffered 2: _mcBlendingLow 3: _mcBlendingPrevious 4: _mcBlendingNext 5: _mcBlendingHigh	0*3	Specify the behavior when executing more than one motion instruction. 0: Aborting 1: Buffered 2: Blending low 3: Blending previous 4: Blending next 5: Blending high

- \*1. Refer to *Unit Conversion Settings* in the *NJ/NX-series CPU Unit Motion Control User's Manual (Cat. No. W507)* for information on command units.
- \*2. Always set the target velocity. If the axis is moved without setting a target velocity, an error will occur.
- \*3. The default value for an enumeration variable is actually not the number, but the enumerator.

## Output Variables

Name	Meaning	Data type	Valid range	Description
Done	Done	BOOL	TRUE or FALSE	TRUE when the instruction is completed.
Busy	Executing	BOOL	TRUE or FALSE	TRUE when the instruction is acknowledged.
Active	Controlling	BOOL	TRUE or FALSE	TRUE when the axis is being controlled.
CommandAborted	Command Aborted	BOOL	TRUE or FALSE	TRUE when the instruction is aborted.
Error	Error	BOOL	TRUE or FALSE	TRUE while there is an error.
ErrorID	Error Code	WORD	*1	Contains the error code when an error occurs. A value of 16#0000 indicates normal execution.

- \*1. The upper four digits of the event code give the error code for ErrorID. Refer to the *NJ/NX-series Troubleshooting Manual (Cat. No. W503)* for the event codes.

### ● Output Variable Update Timing

Name	Timing for changing to TRUE	Timing for changing to FALSE
Done	When positioning is completed.	<ul style="list-style-type: none"> <li>When <i>Execute</i> is TRUE and changes to FALSE.</li> <li>After one period when <i>Execute</i> is FALSE.</li> </ul>
Busy	When <i>Execute</i> changes to TRUE.	<ul style="list-style-type: none"> <li>When <i>Done</i> changes to TRUE.</li> <li>When <i>Error</i> changes to TRUE.</li> <li>When <i>CommandAborted</i> changes to TRUE.</li> </ul>
Active	When the instruction is started.	<ul style="list-style-type: none"> <li>When <i>Done</i> changes to TRUE.</li> <li>When <i>Error</i> changes to TRUE.</li> <li>When <i>CommandAborted</i> changes to TRUE.</li> </ul>



Name	Timing for changing to TRUE	Timing for changing to FALSE
CommandAborted	<ul style="list-style-type: none"> <li>When this instruction is aborted because another motion control instruction was executed with the Buffer Mode set to <b>Aborting</b>.</li> <li>When this instruction is canceled due to an error.</li> <li>When this instruction is executed while there is an error.</li> <li>When you start this instruction during MC_Stop instruction execution.</li> </ul>	<ul style="list-style-type: none"> <li>When <i>Execute</i> is TRUE and changes to FALSE.</li> <li>After one period when <i>Execute</i> is FALSE.</li> </ul>
Error	When there is an error in the execution conditions or input parameters for the instruction.	When the error is cleared.

## In-Out Variables

Name	Meaning	Data type	Valid range	Description
Axis	Axis	_sAXIS_REF	---	Specifies the axis. *1

\*1. Specify a user-defined Axis Variable that was created in the Axis Basic Settings of the Sysmac Studio (default: MC\_Axis\*) or a system-defined axis variable name (\_MC\_AX[\*], \_MC1\_AX[\*], or \_MC2\_AX[\*]).

If you use Sysmac Studio version 1.29 or higher, you can specify the system-defined axis variable name for AT specification of a user-defined variable. This will allow you to specify the user-defined variable.

If you use Sysmac Studio version 1.28 or lower, do not specify any user-defined variable created in the variable table.

## Function

- The travel distance from the command current position is specified to perform positioning.
- Relative positioning starts when *Execute* changes to TRUE.
- You can specify the *Velocity* (Target Velocity), *Acceleration* (Acceleration Rate), *Deceleration* (Deceleration Rate), and *Jerk* as input variables.

The following chart shows an operation example of relative positioning.

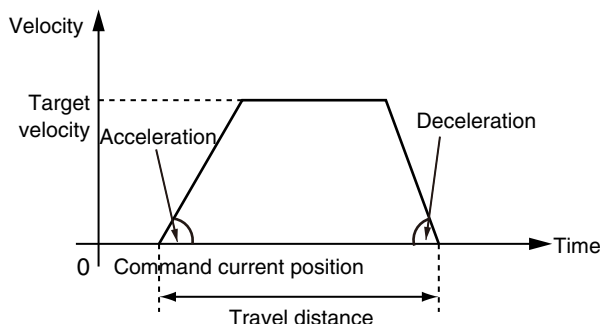

When the *Acceleration* (Acceleration Rate) or *Deceleration* (Deceleration Rate) is 0 and the instruction is executed, it will reach the target velocity without accelerating or decelerating.

The following chart shows an operation example of when the *Deceleration* (Deceleration Rate) is 0.

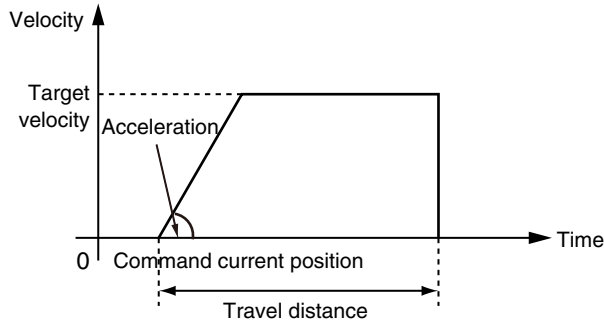

Specify *Jerk* when you want to accelerate or decelerate smoothly. The following chart shows an operation example when *Jerk* is specified.

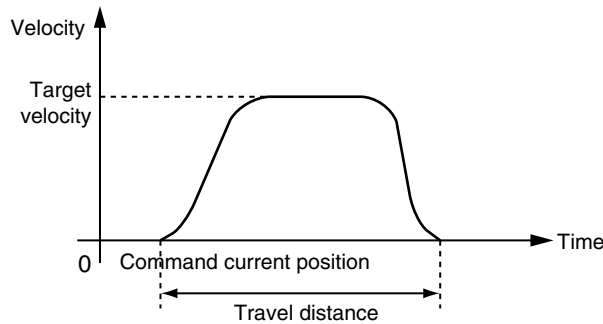

For details on *Jerk*, refer to the *NJ/NX-series CPU Unit Motion Control User's Manual (Cat. No. W507)*.

## Instruction Details

When the Count Mode is **Rotary Mode** you can specify a *Distance* (Travel Distance) that exceeds the relative distance range from the **Modulo Minimum Position Setting Value** axis parameter to the **Modulo Maximum Position Setting Value** axis parameter so that you can perform multiple ring rotation positioning.

The following chart shows an operation example when the command current position is -20 and *Distance* (Travel Distance) is 300.

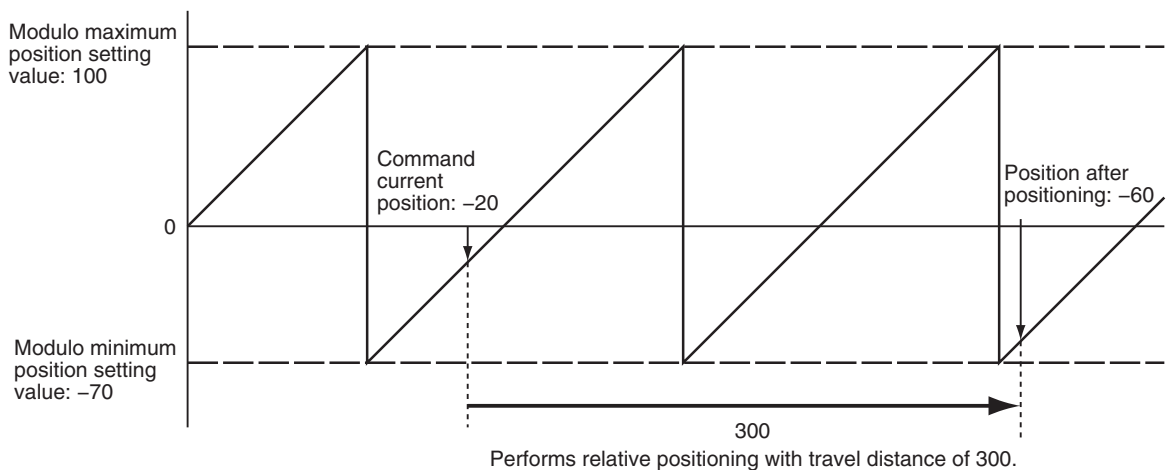

When *Distance* (Travel Distance) is 0 and the instruction is executed, the axis will not move, but *Done* will change to TRUE.



### Precautions for Correct Use

Observe the following precautions if you re-execute relative positioning just before the completion of positioning.

If positioning is completed before the MC Function Module re-executes the instruction, normal instruction execution is performed.

- For normal instruction execution, positioning is performed to the relative value that is based on the position of the axis when the instruction is executed.
- For re-execution of an instruction, positioning is performed to the relative value that is based on the position of the axis when original instruction was executed.

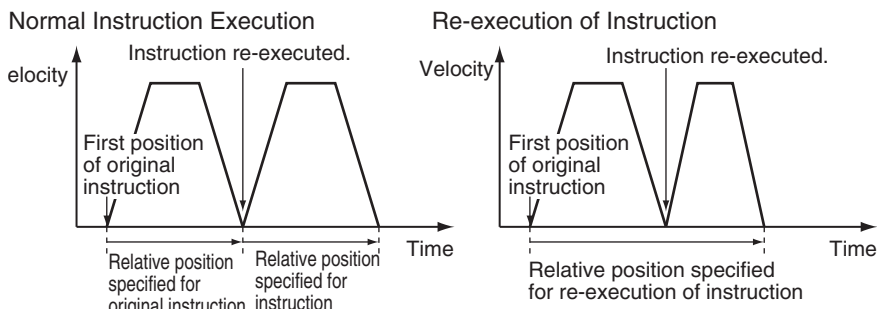

### ● In-position Check

An in-position check is performed for this instruction according to the settings in **In-position Range** and **In-position Check Time** axis parameters.

## Timing Charts

- *Busy* (Executing) changes to TRUE at the same time as *Execute* changes to TRUE. *Active* (Controlling) changes to TRUE in the next period.
- *Done* changes to TRUE when *Distance* (Target Distance) is reached and positioning is completed.
- If another instruction aborts this instruction, *CommandAborted* changes to TRUE and *Busy* (Executing) and *Active* (Controlling) change to FALSE.

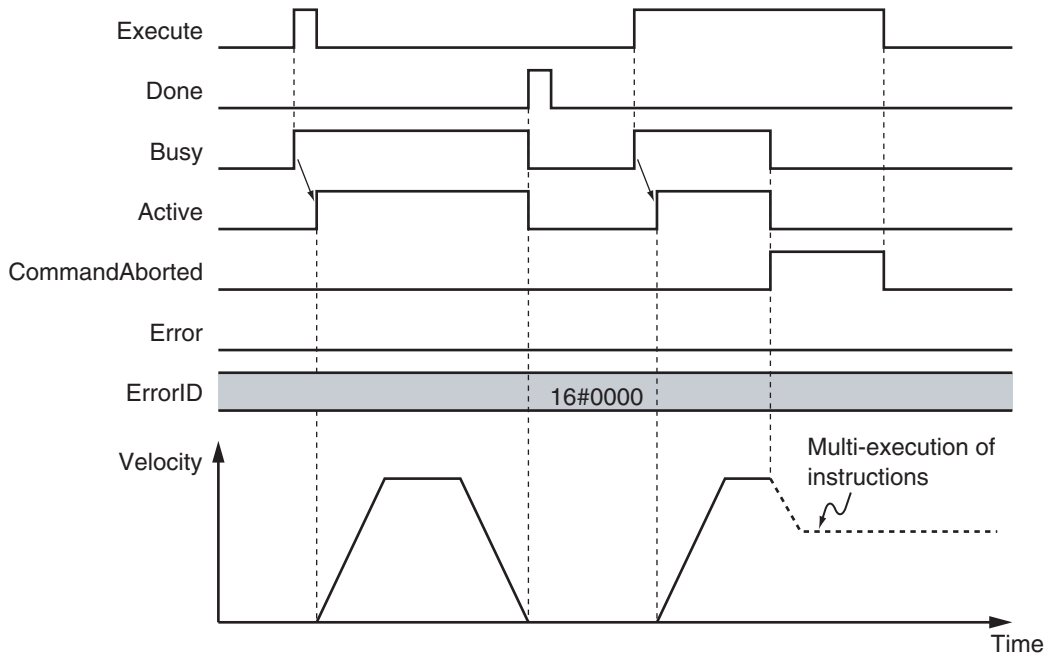

## Re-execution of Motion Control Instructions

You can change the operation of the instruction if you change an input variable during positioning and change *Execute* to TRUE again.

Input variables *Distance* (Travel Distance), *Velocity* (Target Velocity), *Acceleration* (Acceleration Rate), and *Deceleration* (Deceleration Rate) can be changed by re-executing the motion control instruction. The starting point for *Distance* (Travel Distance) when the instruction is re-executed is not the command current position for the re-execution, but rather it is the command current position when the instruction was first executed.

The following chart shows an operation example when a motion control instruction is re-executed twice with different values for *Distance* (Travel Distance) and *Velocity* (Target Velocity).

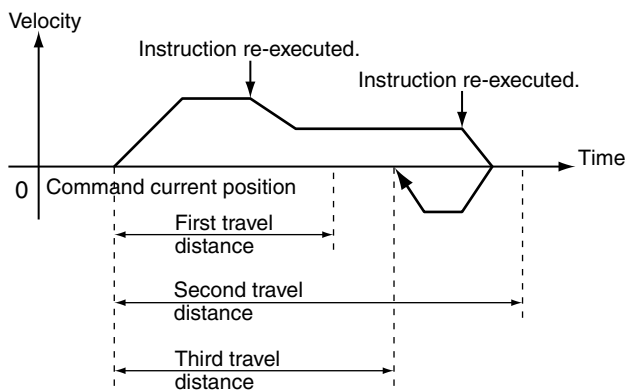



### Precautions for Correct Use

To change any input parameter other than *Distance* (Travel Distance), re-execute the instruction with *Distance* (Travel Distance) assigned to the same value as the original instruction. For example, if *Distance* (Travel Distance) is changed to 0 when the instruction is re-executed, the re-executed instruction will use a *Distance* (Travel Distance) of 0 from the first time it is executed. This will cause the axis to return to the original first position, as shown below.

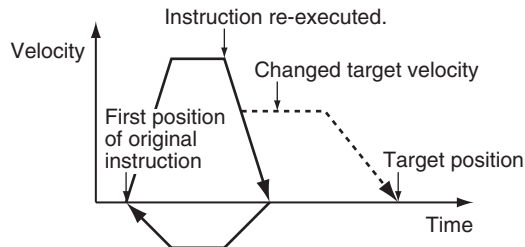

For details on re-execution of motion control instructions, refer to the *NJ/NX-series CPU Unit Motion Control User's Manual (Cat. No. W507)*.

## Multi-execution of Motion Control Instructions

For details on multi-execution of motion control instructions, refer to the *NJ/NX-series CPU Unit Motion Control User's Manual (Cat. No. W507)*.

### ● Execution during Execution of Other Instructions

You can switch to this instruction or buffer this instruction if you execute it during execution of another instruction.

You can buffer one instruction per axis.

The starting point for *Distance* (Travel Distance) for multi-execution of the motion instruction is the command current position when *Active* (Controlling) changes to TRUE after the start of instruction execution.

Specify the operation of this instruction using *BufferMode* (Buffer Mode Selection) for multi-execution of instructions.

Buffer Mode Selection	Description
Aborting	Aborts the instruction being executed and switches to this instruction. If the direction of axis motion is reversed by switching instructions, the motion will be reversed according to the <b>Operation Selection at Reversing</b> axis parameter.
Buffered	Buffers this instruction and executes it automatically after the current instruction is completed.
Blending	Starts the buffered instruction at the velocity (transit velocity) at which the current instruction reaches the target position. The operation of the current instruction is changed so that the axes reach the target position at the transit velocity. There are four methods to specify the transit velocity. These are described below.

Buffer Mode Selection	Description
Blending low	The lower of the target velocities of the current instruction and the buffered instruction is used as the transit velocity.
Blending previous	The target velocity of the current instruction is used as the transit velocity.
Blending next	The target velocity of the buffered instruction is used as the transit velocity.
Blending high	The higher of the target velocities of the current instruction and the buffered instruction is used as the transit velocity.

For details on *BufferMode* (Buffer Mode Selection), refer to the *NJ/NX-series CPU Unit Motion Control User's Manual (Cat. No. W507)*.

#### ● Execution of Other Instructions during Instruction Execution

If you execute another instruction during execution of this instruction, you can specify **Aborting**, **Buffered**, or **Blending**.

## Errors

If an error occurs during instruction execution, *Error* will change to TRUE.

You can find out the cause of the error by referring to the value output by *ErrorID* (Error Code).

#### ● Timing Chart When Error Occurs

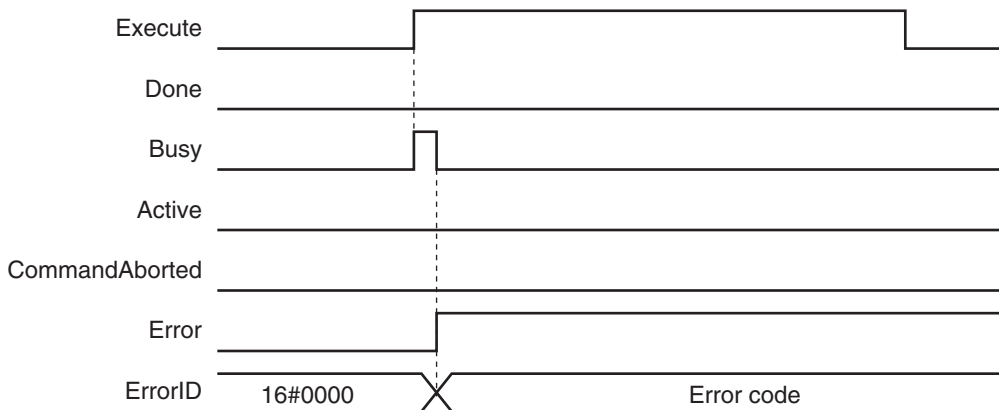

#### ● Error Codes

Refer to the *NJ/NX-series Troubleshooting Manual (Cat. No. W503)* for instruction errors.

# MC\_MoveVelocity

The MC\_MoveVelocity instruction performs velocity control with the Position Control Mode of the Servo Drive.

Instruction	Name	FB/ FUN	Graphic expression	ST expression
MC_MoveVelocity	Velocity Control	FB		<pre>MC_MoveVelocity_instance (   Axis :=parameter,   Execute :=parameter,   Velocity :=parameter,   Acceleration :=parameter,   Deceleration :=parameter,   Jerk :=parameter,   Direction :=parameter,   Continuous :=parameter,   BufferMode :=parameter,   InVelocity =&gt;parameter,   Busy =&gt;parameter,   Active =&gt;parameter,   CommandAborted =&gt;parameter,   Error =&gt;parameter,   ErrorID =&gt;parameter );</pre>

## Variables

### Input Variables

Name	Meaning	Data type	Valid range	De- fault	Description
Execute	Execute	BOOL	TRUE or FALSE	FALSE	The instruction is executed when the value of this variable changes to TRUE.
Velocity	Target Velocity	LREAL	Non-negative number	0	Set the target velocity. The unit is command units/s.* <sup>1</sup>
Acceleration	Acceleration Rate	LREAL	Non-negative number	0	Specify the acceleration rate. The unit is command units/s <sup>2</sup> .* <sup>1</sup>
Deceleration	Deceleration Rate	LREAL	Non-negative number	0	Specify the deceleration rate. The unit is command units/s <sup>2</sup> .* <sup>1</sup>
Jerk	Jerk	LREAL	Non-negative number	0	Specify the jerk. The unit is command units/s <sup>3</sup> .* <sup>1</sup>
Direction	Direction	_eMC_DIRECTION	0: _mcPositiveDirection 2: _mcNegativeDirection 3: _mcCurrentDirection	0 * <sup>2</sup>	Specify the rotation direction. 0: Positive direction 2: Negative direction 3: Current direction

Name	Meaning	Data type	Valid range	De- fault	Description
BufferMode	Buffer Mode Selection	_eMC_BUF- FER_MODE	0: _mcAborting 1: _mcBuffered	0 *2	Specify the behavior when executing more than one motion instruction. 0: Aborting 1: Buffered
Continuous (Reserved)	Continuation Mode Selection	BOOL	TRUE or FALSE	FALSE	(Reserved)

\*1. Refer to *Unit Conversion Settings* in the *NJ/NX-series CPU Unit Motion Control User's Manual (Cat. No. W507)* for information on command units.

\*2. The default value for an enumeration variable is actually not the number, but the enumerator.

## Output Variables

Name	Meaning	Data type	Valid range	Description
InVelocity	Target Velocity Reached	BOOL	TRUE or FALSE	TRUE when the target velocity is reached.
Busy	Executing	BOOL	TRUE or FALSE	TRUE when the instruction is acknowledged.
Active	Controlling	BOOL	TRUE or FALSE	TRUE when the axis is being controlled.
CommandAborted	Command Aborted	BOOL	TRUE or FALSE	TRUE when the instruction is aborted.
Error	Error	BOOL	TRUE or FALSE	TRUE while there is an error.
ErrorID	Error Code	WORD	*1	Contains the error code when an error occurs. A value of 16#0000 indicates normal execution.

\*1. The upper four digits of the event code give the error code for ErrorID. Refer to the *NJ/NX-series Troubleshooting Manual (Cat. No. W503)* for the event codes.

### ● Output Variable Update Timing

Name	Timing for changing to TRUE	Timing for changing to FALSE
InVelocity	When the target velocity is reached.	<ul style="list-style-type: none"> <li>When <i>Error</i> changes to TRUE.</li> <li>When <i>CommandAborted</i> changes to TRUE.</li> <li>When the instruction is re-executed and the target velocity is changed.</li> </ul>
Busy	When <i>Execute</i> changes to TRUE.	<ul style="list-style-type: none"> <li>When <i>Error</i> changes to TRUE.</li> <li>When <i>CommandAborted</i> changes to TRUE.</li> </ul>
Active	When the instruction is started.	<ul style="list-style-type: none"> <li>When <i>Error</i> changes to TRUE.</li> <li>When <i>CommandAborted</i> changes to TRUE.</li> </ul>



Name	Timing for changing to TRUE	Timing for changing to FALSE
CommandAborted	<ul style="list-style-type: none"> <li>When this instruction is aborted because another motion control instruction was executed with the Buffer Mode set to <b>Aborting</b> or <b>Buffered</b>.</li> <li>When this instruction is canceled due to an error.</li> <li>When this instruction is executed while there is an error.</li> <li>When you start this instruction during MC_Stop instruction execution.</li> </ul>	<ul style="list-style-type: none"> <li>When <i>Execute</i> is TRUE and changes to FALSE.</li> <li>After one period when <i>Execute</i> is FALSE.</li> </ul>
Error	When there is an error in the execution conditions or input parameters for the instruction.	When the error is cleared.

## In-Out Variables

Name	Meaning	Data type	Valid range	Description
Axis	Axis	_sAXIS_REF	---	Specifies the axis. *1

- \*1. Specify a user-defined Axis Variable that was created in the Axis Basic Settings of the Sysmac Studio (default: MC\_Axis\*) or a system-defined axis variable name (\_MC\_AX[\*], \_MC1\_AX[\*], or \_MC2\_AX[\*]).  
 If you use Sysmac Studio version 1.29 or higher, you can specify the system-defined axis variable name for AT specification of a user-defined variable. This will allow you to specify the user-defined variable.  
 If you use Sysmac Studio version 1.28 or lower, do not specify any user-defined variable created in the variable table.

## Function

- Pseudo velocity control is performed with position control.
- The velocity control operation starts when *Execute* changes to TRUE.

## Instruction Details

This section describes the instruction in detail.

### ● Direction

- Specify the travel direction with *Direction*.
- When *Direction* specifies **0: \_mcPositiveDirection** (Positive direction), the axis moves in the positive direction. When it specifies **2: \_mcNegativeDirection** (Negative direction), the axis moves in the negative direction.
- When *Direction* specifies **3: \_mcCurrentDirection** (Current direction), the axis motion depends on whether the axis is stopped or not. If the axis is stopped, it will move in the direction in which it was traveling previously. If the power is turned ON or after restarting, the axis moves in the positive direction.

If you execute this instruction during multi-execution of motion control instructions for the axis, the axis will move in the direction that it is currently traveling.



### Precautions for Correct Use

If **3: `_mcCurrentDirection`** (Current direction) is specified for *Direction*, operation is in the same command direction as the previous motion. Therefore, depending on the instructions that are used together, the direction may not be the same as the direction that was specified with the input to the motion control instruction for the previous motion.

When you specify **3: `_mcCurrentDirection`** (Current direction), check the current direction with *Dir.Posi* (Positive Direction) and *Dir.Nega* (Negative Direction) in the Axis Variable.

## Timing Charts

- *Busy* (Executing) changes to TRUE at the same time as *Execute* changes to TRUE. *Active* (Controlling) changes to TRUE in the next period.
- *InVelocity* (Target Velocity Reached) changes to TRUE when *Velocity* (Target Velocity) is reached.
- If another instruction aborts this instruction, *CommandAborted* changes to TRUE and *Busy* (Executing), *Active* (Controlling), and *InVelocity* (Target Velocity Reached) change to FALSE.

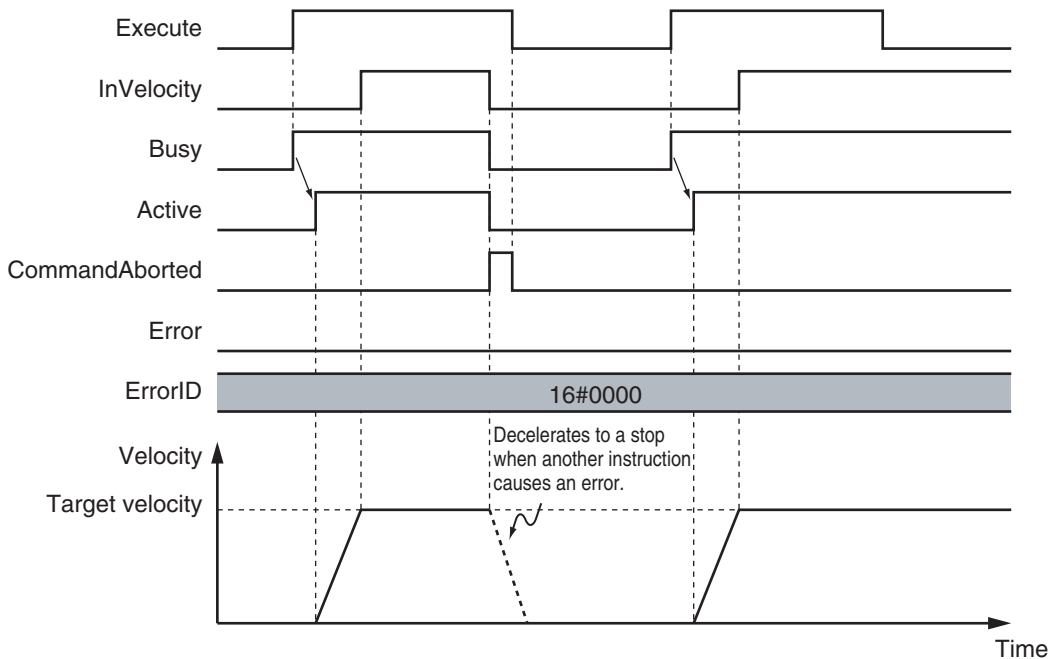

The *InVelocity* (Target Velocity Reached) output variable indicates when the velocity has reached the same velocity for this instruction and the re-executed motion control instruction. Therefore, after *InVelocity* (Target Velocity Reached) changes to TRUE, even if the velocity is changed by the override factor, *InVelocity* (Target Velocity Reached) will not change to FALSE.

If the override factor changes before *InVelocity* (Target Velocity Reached) changes to TRUE, *InVelocity* (Target Velocity Reached) will change to TRUE when the new target velocity is reached.

You can specify *Acceleration* (Acceleration Rate), *Deceleration* (Deceleration Rate) and *Jerk* as input variables.

When the *Velocity* (Target Velocity) is 0 and the instruction is executed, the axis will enter continuous operation without motion.

The following chart shows an operation example of when *Velocity* (Target Velocity) is 0.

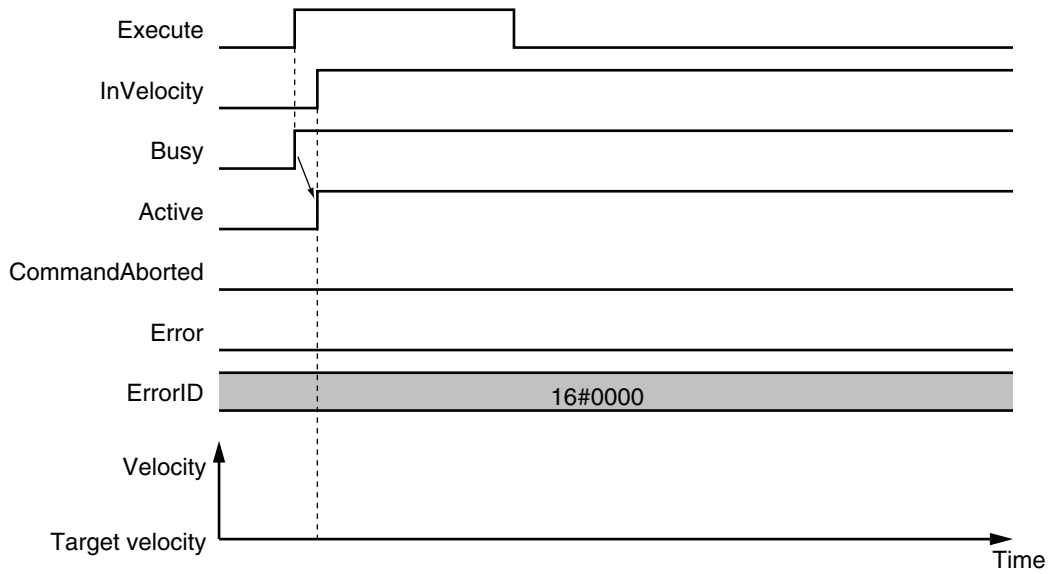

When the *Acceleration* (Acceleration Rate) or *Deceleration* (Deceleration Rate) is 0 and the instruction is executed, the axis will reach the target velocity without accelerating or decelerating. The following chart shows an operation example of when the *Acceleration* (Acceleration Rate) is 0.

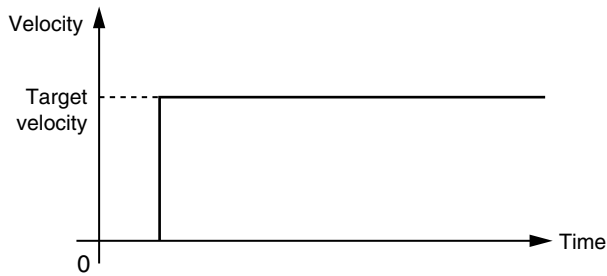

Specify *Jerk* when you want to accelerate or decelerate smoothly. The following chart shows an operation example when *Jerk* is specified.

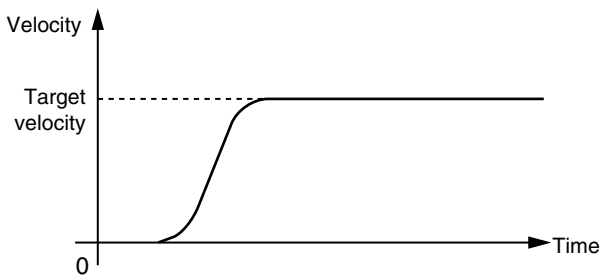

For details on *Jerk*, refer to the *NJ/NX-series CPU Unit Motion Control User's Manual (Cat. No. W507)*.

## Re-execution of Motion Control Instructions

You can change the operation of the instruction if you change an input parameter during continuous operation and then change *Execute* to TRUE again.

Input variables *Velocity* (Target Velocity), *Acceleration* (Acceleration Rate), and *Deceleration* (Deceleration Rate) can be changed by re-executing the motion control instruction.

When *Velocity* (Target Velocity) is changed by re-executing a motion control instruction, *InVelocity* (Target Velocity Reached) operates for the new target velocity that was set at re-execution.

For details on re-execution of motion control instructions, refer to the *NJ/NX-series CPU Unit Motion Control User's Manual (Cat. No. W507)*.

## Multi-execution of Motion Control Instructions

For details on multi-execution of motion control instructions, refer to the *NJ/NX-series CPU Unit Motion Control User's Manual (Cat. No. W507)*.

### ● Execution during Execution of Other Instructions

You can switch to this instruction or buffer this instruction if you execute it during execution of another instruction.

You can buffer one instruction per axis.

Specify the operation of this instruction using *BufferMode* (Buffer Mode Selection) for multi-execution of instructions.

Buffer Mode Selection	Description
Aborting	Aborts the instruction being executed and switches to this instruction. If the direction of axis motion is reversed by switching instructions, the motion will be reversed according to the <b>Operation Selection at Reversing</b> axis parameter.
Buffered	Buffers this instruction and executes it automatically after the current instruction is completed.

For details on *BufferMode* (Buffer Mode Selection), refer to the *NJ/NX-series CPU Unit Motion Control User's Manual (Cat. No. W507)*.

### ● Execution of Other Instructions during Instruction Execution

If another instruction is executed during execution of this instruction, the *BufferMode* input variable to the other instruction must be set to **Aborting** or **Buffered**.

If you specify **Buffered**, the buffered instruction is executed when the *InVelocity* (Target Velocity Reached) output variable from this instruction changes to TRUE.

## Errors

If an error occurs during instruction execution, *Error* will change to TRUE.

You can find out the cause of the error by referring to the value output by *ErrorID* (Error Code).

● **Timing Chart When Error Occurs**

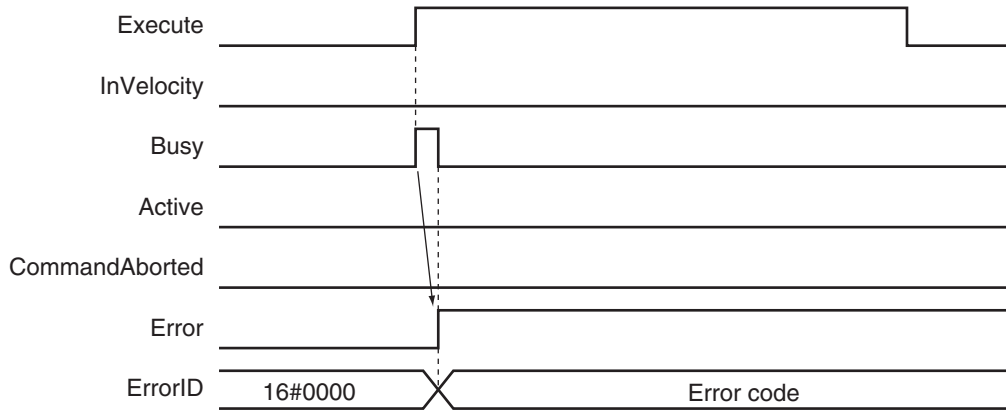

● **Error Codes**

Refer to the *NJ/NX-series Troubleshooting Manual (Cat. No. W503)* for instruction errors.

**Sample Programming**

This section shows sample programming for velocity control, such as for a spinner or centrifuge.

**Parameter Settings**

The minimum settings required for this sample programming are given below.

● **Setting Axis Parameters**

Axis Type

Axis	Axis Type
Axis 1	Servo axis

**Operation Example**

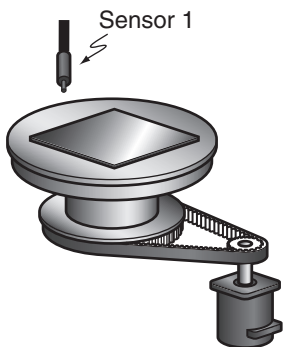

## ● Operation Pattern

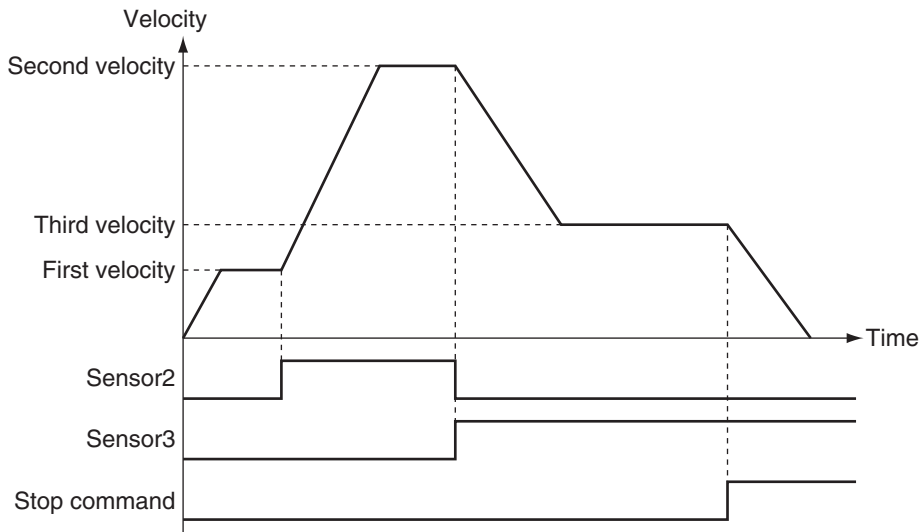

- 1** Starting Velocity Control  
Sensor 1 detects the insertion of liquid chemical. When it turns ON, velocity control starts for axis 1.
- 2** Changing to the Second Velocity  
When the Sensor2 bit changes to TRUE, the override factor is set to 500% and the velocity is changed.
- 3** Changing to the Third Velocity  
When the Sensor3 bit changes to TRUE, the override factor is set to 200% and the velocity is changed.  
If both Sensor2 and Sensor3 are TRUE at the same time, the override factor is 200%.
- 4** Stopping Velocity Control  
When the stop command (StopTrig) changes to TRUE, the axis decelerates to a stop.

## Ladder Diagram

### ● Main Variables

Name	Data type	Default	Comment
MC_Axis000	_sAXIS_REF	---	Axis Variable for axis 1.
MC_Axis000.MFaultLvl.Active	BOOL	FALSE	TRUE while there is a minor fault level error for axis 1.
MC_Axis000.Details.Homed	BOOL	FALSE	TRUE when home is defined for axis 1.
Pwr_Status	BOOL	FALSE	This variable is assigned to the <i>Status</i> output variable from the PWR instance of the MC_Power instruction. This variable changes to TRUE when the Servo is turned ON.

Name	Data type	Default	Comment
StartPg	BOOL	FALSE	The Servo is turned ON if this variable is TRUE and EtherCAT process data communications are established.
Vel_Act	BOOL	FALSE	This variable is assigned to the <i>Active</i> output variable from the VEL instance of the MC_MoveVelocity instruction. It is TRUE during velocity control by the VEL instance.
Set_Ov_Velfct	LREAL	0	This is the velocity override factor.
StopTrig	BOOL	FALSE	When this variable is TRUE, MC_Stop is executed.
Sensor1	BOOL	FALSE	TRUE when chemical solution supply is detected. If the Servo is ON for axis 1, the MC_MoveVelocity (Velocity Control) instruction is executed.
Sensor2	BOOL	FALSE	If this variable is TRUE, the override factor is set to 500%. After this variable changes to TRUE, it remains TRUE until Sensor3 changes to TRUE, at which time it changes to FALSE.
Sensor3	BOOL	FALSE	If this variable is TRUE, the override factor is set to 200%. After this variable changes to TRUE, it remains TRUE.

● Timing Chart

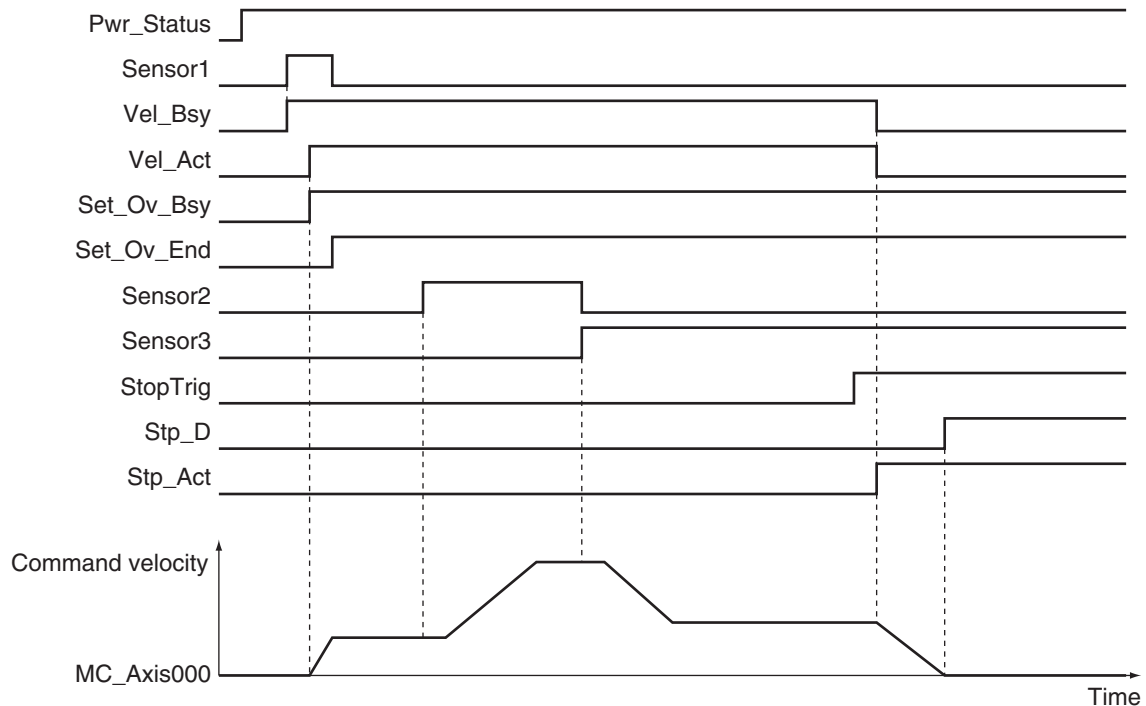

● Sample Programming

If *StartPg* is TRUE, check that the Servo Drive is ready.

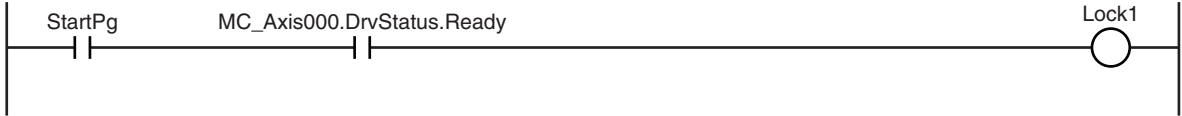

If the Servo Drive is ready, the Servo is turned ON.

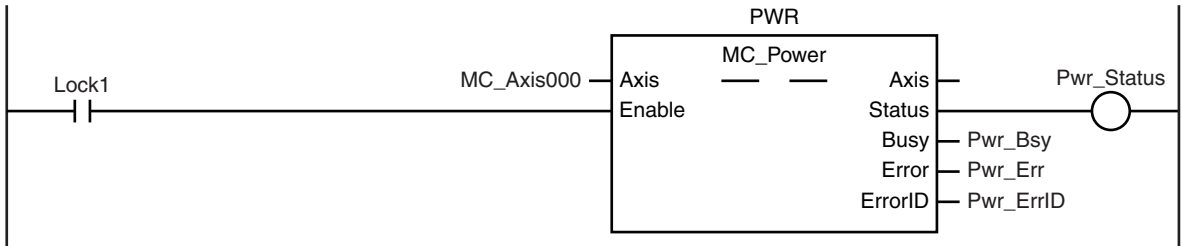

If a minor fault level error occurs for axis 1, the error handler for the device (FaultHandler) is executed. Program the FaultHandler according to the device.

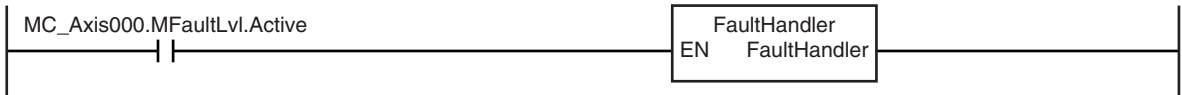

When *Sensor1* changes to TRUE, the MC\_MoveVelocity (Velocity Control) instruction is executed.

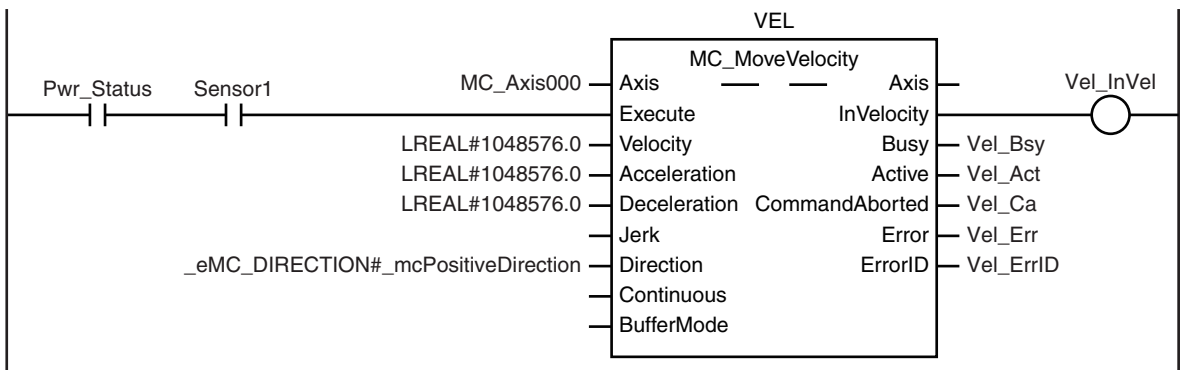

During execution of the MC\_MoveVelocity (Velocity Control) instruction, the override factor is changed according to the status of the Sensor2 and Sensor3 bits.

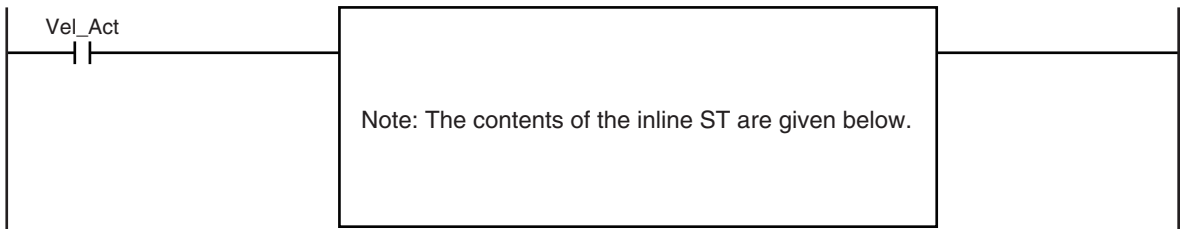



The MC\_SetOverride (Set Override Factors) instruction is executed during execution of the MC\_MoveVelocity (Velocity Control) instruction.

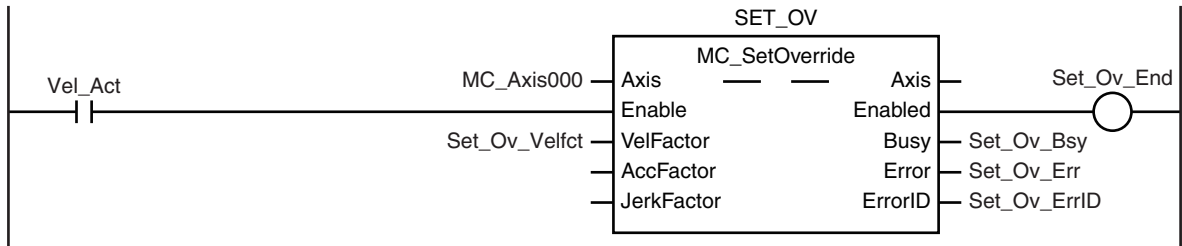

When the stop command (*StopTrig*) changes to TRUE, the MC\_Stop instruction is executed.

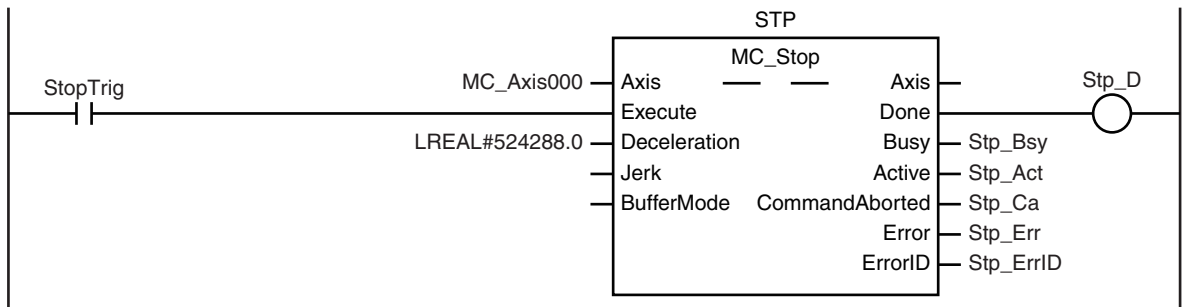

**Contents of Inline ST**

```

IF (Sensor2=FALSE) AND (Sensor3=FALSE) THEN
    Set_Ov_Velfct := LREAL#100.0;
ELSIF (Sensor2=TRUE) AND (Sensor3=FALSE) THEN
    Set_Ov_Velfct := LREAL#500.0;
ELSIF (Sensor2=FALSE) AND (Sensor3=TRUE) THEN
    Set_Ov_Velfct := LREAL#200.0;
ELSE
    Set_Ov_Velfct := LREAL#200.0;
END_IF;
    
```

**Structured Text (ST)**

● **Main Variables**

Name	Data type	Default	Comment
MC_Axis000	_sAXIS_REF	---	Axis Variable for axis 1.
MC_Axis000.MFaultLvl.Active	BOOL	FALSE	TRUE while there is a minor fault level error for axis 1.
MC_Axis000.Details.Homed	BOOL	FALSE	TRUE when home is defined for axis 1.
Pwr_Status	BOOL	FALSE	This variable is assigned to the <i>Status</i> output variable from the PWR instance of the MC_Power instruction. This variable changes to TRUE when the Servo is turned ON.
StartPg	BOOL	FALSE	The Servo is turned ON if this variable is TRUE and EtherCAT process data communications are established.

Name	Data type	Default	Comment
Vel_Act	BOOL	FALSE	This variable is assigned to the <i>Active</i> output variable from the VEL instance of the MC_MoveVelocity instruction. It is TRUE during velocity control by the VEL instance.
Set_Ov_Velfct	LREAL	0	This is the velocity override factor.
StopTrig	BOOL	FALSE	When this variable is TRUE, MC_Stop is executed.
Sensor1	BOOL	FALSE	TRUE when chemical solution supply is detected. If the Servo is ON for axis 1, the MC_MoveVelocity (Velocity Control) instruction is executed.
Sensor2	BOOL	FALSE	If this variable is TRUE, the override factor is set to 500%. After this variable changes to TRUE, it remains TRUE until Sensor3 changes to TRUE, at which time it changes to FALSE.
Sensor3	BOOL	FALSE	If this variable is TRUE, the override factor is set to 200%. After this variable changes to TRUE, it remains TRUE.
Vel_Ex	BOOL	FALSE	The VEL instance of MC_MoveVelocity is executed when this variable changes to TRUE.
Set_Ov_En	BOOL	FALSE	The SET_OV instance of MC_SetOverride is executed while this variable is TRUE.
Stp_Ex	BOOL	FALSE	The STP instance of MC_Stop is executed when this variable changes to TRUE.
InitFlag	BOOL	FALSE	This variable indicates if it is necessary to set the input parameters. Input parameters are set when this variable is FALSE. When setting the input parameters is completed, this variable changes to TRUE.

## ● Timing Chart

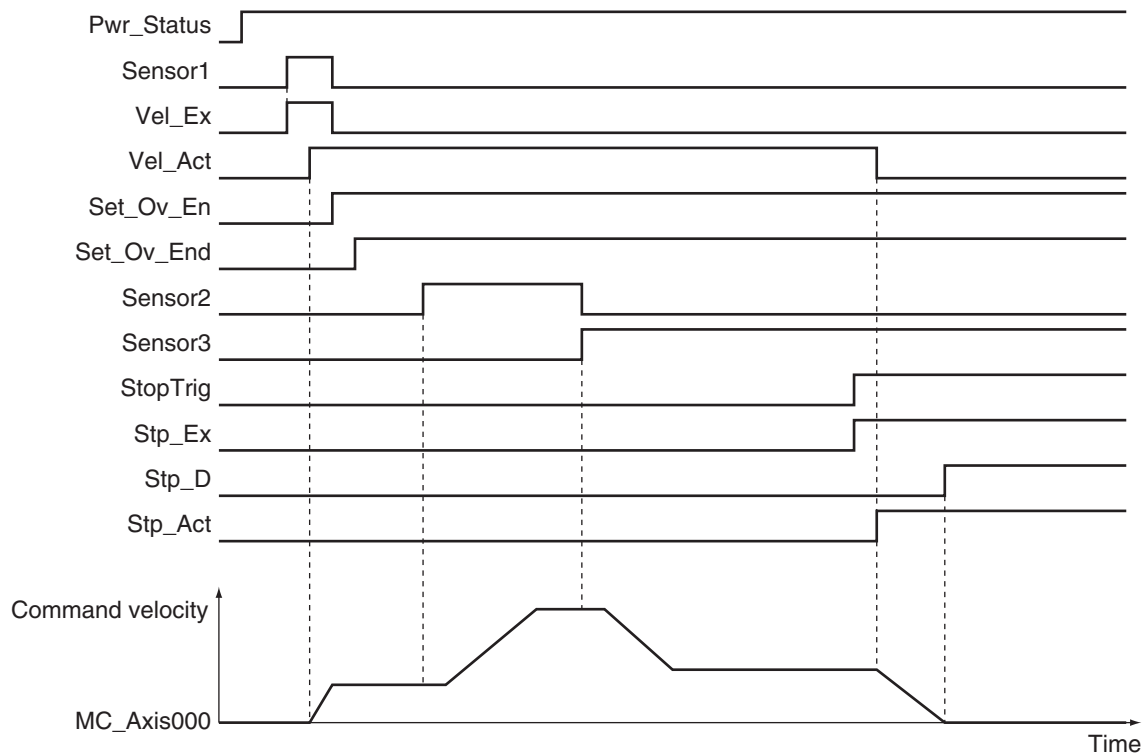

## ● Sample Programming

```
// Processing when input parameters are not set
IF InitFlag = FALSE THEN

    // MC_MoveVelocity parameters
    Vel_Vel := LREAL#1048576.0;
    Vel_Acc := LREAL#1048576.0;
    Vel_Dec := LREAL#1048576.0;
    Vel_Dir := _eMC_DIRECTION#_mcPositiveDirection;

    // MC_SetOverride parameters
    Set_Ov_Velfct := LREAL#100.0;

    // MC_Stop parameters
    Stp_Dec := LREAL#524288.0;

    // Change InitFlag to TRUE after setting the input parameters.
    InitFlag:=TRUE;

END_IF;

// If StartPg is TRUE and the Servo Drive is ready, the Servo for axis 1 is turned
ON.
// If the Servo Drive is not ready, the Servo is turned OFF.
IF (StartPg=TRUE)
```

```

    AND (MC_Axis000.DrvStatus.Ready=TRUE) THEN
        Pwr_En:=TRUE;
ELSE
    Pwr_En:=FALSE;
END_IF;

// If a minor fault level error occurs for axis 1, the error handler for the device
(FaultHandler) is executed.
// Program the FaultHandler according to the device.
IF MC_Axis000.MFaultLvl.Active=TRUE THEN
    FaultHandler();
END_IF;

// If the Servo is ON for axis 1 and the Sensor1 bit is TRUE, the MC_MoveVelocity i
nstruction is executed.
IF (Pwr_Status=TRUE) AND (Sensor1=TRUE) THEN
    Vel_Ex := TRUE;
END_IF;

// During execution of the MC_MoveVelocity instruction, the override factor is chan
ged according to the status of the Sensor2 and Sensor3 bits.
IF Vel_Act=TRUE THEN
    IF (Sensor2=FALSE) AND (Sensor3=FALSE) THEN
        Set_Ov_Velfct := LREAL#100.0;
    ELSIF (Sensor2=TRUE) AND (Sensor3=FALSE) THEN
        Set_Ov_Velfct := LREAL#500.0;
    ELSIF (Sensor2=FALSE) AND (Sensor3=TRUE) THEN
        Set_Ov_Velfct := LREAL#200.0;
    ELSE
        Set_Ov_Velfct := LREAL#200.0;
    END_IF;
END_IF;

// The MC_SetOverride instruction is executed during velocity control for the MC_Mo
veVelocity instruction.
IF Vel_Act=TRUE THEN
    Set_Ov_En := TRUE;
END_IF;

// The MC_Stop instruction is executed when StopTrig is TRUE.
IF StopTrig=TRUE THEN
    Stp_Ex := TRUE;
END_IF;

// MC_Power
PWR(
    Axis := MC_Axis000,

```

```

    Enable := Pwr_En,
    Status => Pwr_Status,
    Busy => Pwr_Bsy,
    Error => Pwr_Err,
    ErrorID => Pwr_ErrID
);

// MC_MoveVelocity
VEL(
    Axis := MC_Axis000,
    Execute := Vel_Ex,
    Velocity := Vel_Vel,
    Acceleration := Vel_Acc,
    Deceleration := Vel_Dec,
    Direction := Vel_Dir,
    InVelocity => Vel_Invel,
    Busy => Vel_Bsy,
    Active => Vel_Act,
    CommandAborted => Vel_Ca,
    Error => Vel_Err,
    ErrorID => Vel_ErrID
);

// MC_SetOverride
SET_OV(
    Axis := MC_Axis000,
    Enable := Set_Ov_En,
    VelFactor := Set_Ov_Velfct,
    AccFactor := Set_Ov_Accfct,
    JerkFactor := Set_Ov_Jfct,
    Busy => Set_Ov_Bsy,
    Enabled => Set_Ov_End,
    Error => Set_Ov_Err,
    ErrorID => Set_Ov_ErrID
);

// MC_Stop
STP(
    Axis := MC_Axis000,
    Execute := Stp_Ex,
    Deceleration := Stp_Dec,
    Done => Stp_D,
    Busy => Stp_Bsy,
    Active => Stp_Act,
    CommandAborted => Stp_Ca,
    Error => Stp_Err,

```

```
ErrorID => Stp_ErrID  
);
```

# MC\_MoveZeroPosition

The MC\_MoveZeroPosition instruction performs positioning with an absolute position of 0 as the target position to return to home.

Instruction	Name	FB/ FUN	Graphic expression	ST expression
MC_MoveZero- Position	High-speed Home	FB		<pre>MC_MoveZeroPosition_instance (   Axis :=parameter,   Execute :=parameter,   Velocity :=parameter,   Acceleration :=parameter,   Deceleration :=parameter,   Jerk :=parameter,   BufferMode :=parameter,   Done =&gt;parameter,   Busy =&gt;parameter,   Active =&gt;parameter,   CommandAborted =&gt;parameter,   Error =&gt;parameter,   ErrorID =&gt;parameter );</pre>

## Variables

### Input Variables

Name	Meaning	Data type	Valid range	De- fault	Description
Execute	Execute	BOOL	TRUE or FALSE	FALSE	The instruction is executed when the value of this variable changes to TRUE.
Velocity	Target Velocity	LREAL	Positive number	0	Specify the target velocity.*1 The unit is command units/s.*2
Acceleration	Acceleration Rate	LREAL	Non-negative number	0	Specify the acceleration rate. The unit is command units/s <sup>2</sup> .*2
Deceleration	Deceleration Rate	LREAL	Non-negative number	0	Specify the deceleration rate. The unit is command units/s <sup>2</sup> .*2
Jerk	Jerk	LREAL	Non-negative number	0	Specify the jerk. The unit is command units/s <sup>3</sup> .*2
BufferMode	Buffer Mode Selection	_eMC_BUFFER_MODE	0: _mcAborting 1: _mcBuffered	0*3	Specify the behavior when executing more than one motion instruction. 0: Aborting 1: Buffered

\*1. Always set the target velocity. If the axis is moved without setting a target velocity, an error will occur.

\*2. Refer to *Unit Conversion Settings* in the *NJ/NX-series CPU Unit Motion Control User's Manual (Cat. No. W507)* for information on command units.

\*3. The default value for an enumeration variable is actually not the number, but the enumerator.

## Output Variables

Name	Meaning	Data type	Valid range	Description
Done	Done	BOOL	TRUE or FALSE	TRUE when the instruction is completed.
Busy	Executing	BOOL	TRUE or FALSE	TRUE when the instruction is acknowledged.
Active	Controlling	BOOL	TRUE or FALSE	TRUE when the axis is being controlled.
CommandAborted	Command Aborted	BOOL	TRUE or FALSE	TRUE when the instruction is aborted.
Error	Error	BOOL	TRUE or FALSE	TRUE while there is an error.
ErrorID	Error Code	WORD	*1	Contains the error code when an error occurs. A value of 16#0000 indicates normal execution.

\*1. The upper four digits of the event code give the error code for ErrorID. Refer to the *NJ/NX-series Troubleshooting Manual (Cat. No. W503)* for the event codes.

### ● Output Variable Update Timing

Name	Timing for changing to TRUE	Timing for changing to FALSE
Done	When positioning is completed.	<ul style="list-style-type: none"> <li>When <i>Execute</i> is TRUE and changes to FALSE.</li> <li>After one period when <i>Execute</i> is FALSE.</li> </ul>
Busy	When <i>Execute</i> changes to TRUE.	<ul style="list-style-type: none"> <li>When <i>Done</i> changes to TRUE.</li> <li>When <i>Error</i> changes to TRUE.</li> <li>When <i>CommandAborted</i> changes to TRUE.</li> </ul>
Active	When the instruction is started.	<ul style="list-style-type: none"> <li>When <i>Done</i> changes to TRUE.</li> <li>When <i>Error</i> changes to TRUE.</li> <li>When <i>CommandAborted</i> changes to TRUE.</li> </ul>
CommandAborted	<ul style="list-style-type: none"> <li>When this instruction is aborted because another motion control instruction was executed with the Buffer Mode set to <b>Aborting</b>.</li> <li>When this instruction is canceled due to an error.</li> <li>When this instruction is executed while there is an error.</li> <li>When you start this instruction during MC_Stop instruction execution.</li> </ul>	<ul style="list-style-type: none"> <li>When <i>Execute</i> is TRUE and changes to FALSE.</li> <li>After one period when <i>Execute</i> is FALSE.</li> </ul>
Error	When there is an error in the execution conditions or input parameters for the instruction.	When the error is cleared.

## In-Out Variables

Name	Meaning	Data type	Valid range	Description
Axis	Axis	_sAXIS_REF	---	Specifies the axis. *1

\*1. Specify a user-defined Axis Variable that was created in the Axis Basic Settings of the Sysmac Studio (default: MC\_Axis\*) or a system-defined axis variable name (\_MC\_AX[\*], \_MC1\_AX[\*], or \_MC2\_AX[\*]).



If you use Sysmac Studio version 1.29 or higher, you can specify the system-defined axis variable name for AT specification of a user-defined variable. This will allow you to specify the user-defined variable.

If you use Sysmac Studio version 1.28 or lower, do not specify any user-defined variable created in the variable table.

## Function

- The axis moves to home.
- You can specify the *Velocity* (Target Velocity), *Acceleration* (Acceleration Rate), *Deceleration* (Deceleration Rate), and *Jerk* as input variables.



### Precautions for Correct Use

Execute the MC\_MoveZeroPosition (High-speed Home) instruction only after defining home. If home is not defined, an Instruction Execution Error with Undefined Home (error code: 5466 hex) occurs.

## Instruction Details

This section describes the instruction in detail.

### ● Direction Designation

When the Count Mode is set to **Rotary Mode**, positioning is performed in the direction with the shortest distance to home (shortest-way positioning).

The following chart shows an operation example of this instruction according to the command current position.

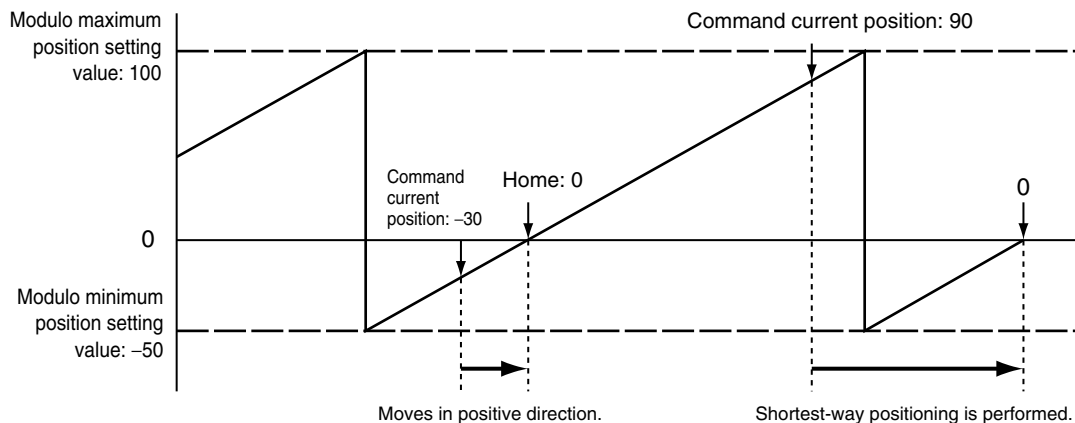

### Precautions for Correct Use

If this instruction is executed when home is outside of the settings of the **Modulo Maximum Position Setting Value** and **Modulo Minimum Position Setting Value** axis parameters, a Target Position Ring Counter Out of Range error (error code: 549C hex) will occur.

### ● Override Factors

Override factors are enabled for this instruction.

### ● In-position Check

An in-position check is performed for this instruction according to the settings in **In-position Range** and **In-position Check Time** axis parameters.

### ● Operation Example

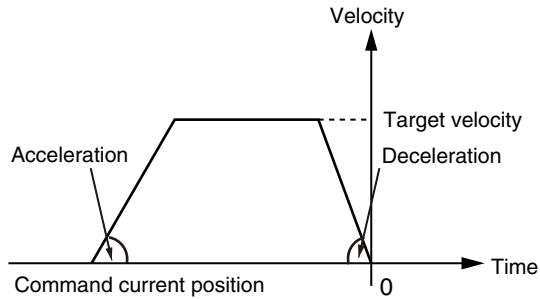

When the *Acceleration* (Acceleration Rate) or *Deceleration* (Deceleration Rate) is 0 and the instruction is executed, it will reach the target velocity without accelerating or decelerating.

The following chart shows an operation example of when the *Acceleration* (Acceleration Rate) is 0.

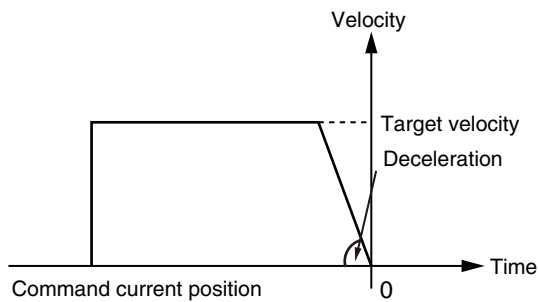

Specify *Jerk* when you want to accelerate or decelerate smoothly.

The following chart shows an operation example when *Jerk* is specified.

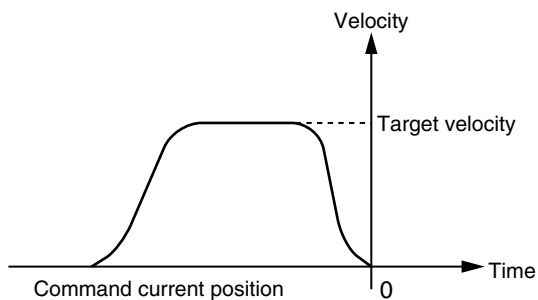

For details on *Jerk*, refer to the *NJ/NX-series CPU Unit Motion Control User's Manual (Cat. No. W507)*.

## Timing Charts

A timing chart for execution of the MC\_MoveZeroPosition (High-speed Home) instruction is shown below.

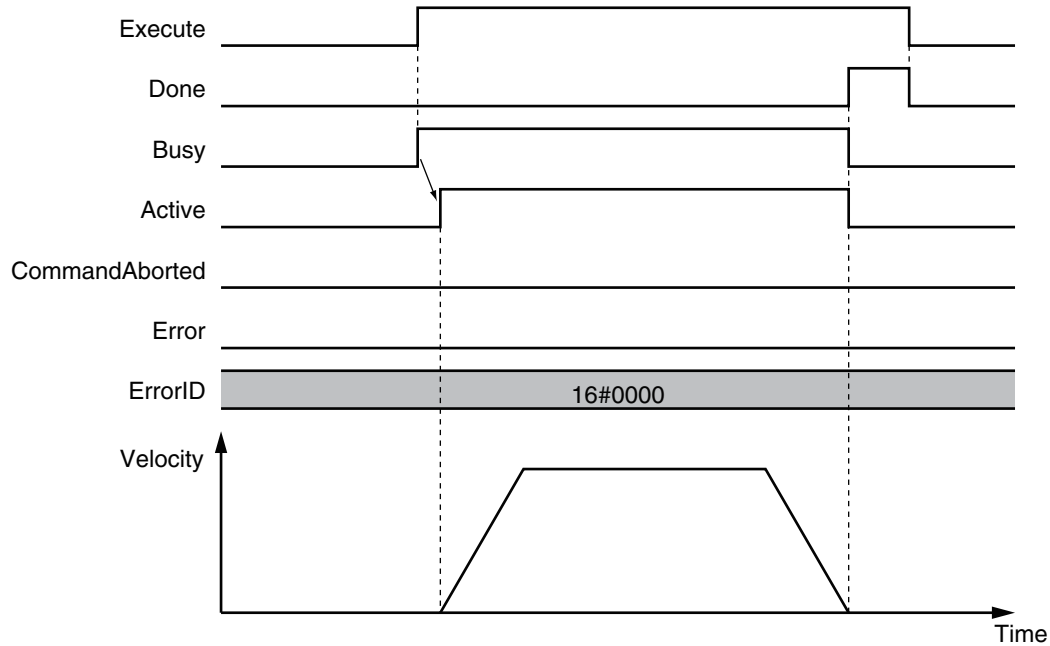

## Aborting the Instruction

Home will not become undefined even if this instruction is aborted and *CommandAborted* changes to TRUE.

## Re-execution of Motion Control Instructions

You can change the operation of the instruction if you change an input variable during positioning and change *Execute* to TRUE again.

Input variables *Velocity* (Target Velocity), *Acceleration* (Acceleration Rate), and *Deceleration* (Deceleration Rate) can be changed by re-executing the motion control instruction.

For details on re-execution of motion control instructions, refer to the *NJ/NX-series CPU Unit Motion Control User's Manual (Cat. No. W507)*.

## Multi-execution of Motion Control Instructions

For details on multi-execution of motion control instructions, refer to the *NJ/NX-series CPU Unit Motion Control User's Manual (Cat. No. W507)*.

### ● Execution during Execution of Other Instructions

You can switch to this instruction or buffer this instruction if you execute it during execution of another instruction.

You can buffer one instruction per axis.

Specify the operation of this instruction using *BufferMode* (Buffer Mode Selection) for multi-execution of instructions.

Buffer Mode Selection	Description
Aborting	Aborts the instruction being executed and switches to this instruction. If the direction of axis motion is reversed by switching instructions, the motion will be reversed according to the <b>Operation Selection at Reversing</b> axis parameter.
Buffered	Buffers this instruction and executes it automatically after the current instruction is completed.

For details on *BufferMode* (Buffer Mode Selection), refer to the *NJ/NX-series CPU Unit Motion Control User's Manual (Cat. No. W507)*.

### ● Execution of Other Instructions during Instruction Execution

If you execute another instruction during execution of this instruction, you can specify either **Aborting** or **Buffered**.

You cannot specify **Blending**.

#### MC\_SetPosition Execution during Instruction Execution

Home becomes undefined for the MC\_SetPosition instruction. Therefore an error will occur if you attempt to execute it during execution of this instruction, and it will not be executed.

If attempting to execute the MC\_SetPosition instruction causes an error, the current instruction decelerates the axis to a stop and *CommandAborted* changes to TRUE.

In this case, the output variable *Error* changes to TRUE for the MC\_SetPosition instruction.

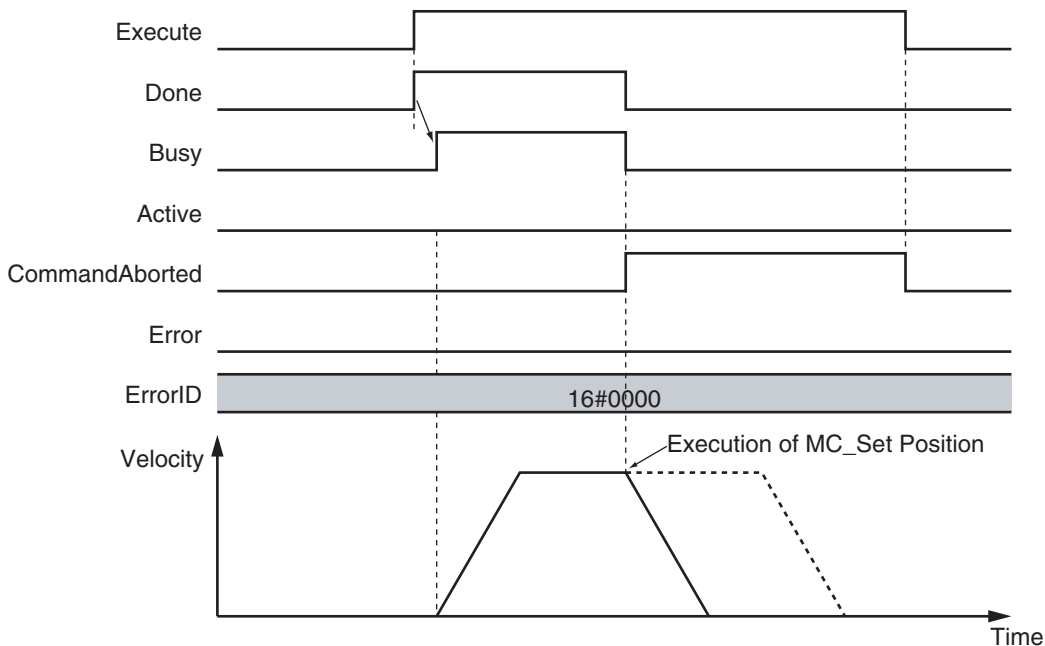

## Errors

If an error occurs during instruction execution, *Error* will change to TRUE.

You can find out the cause of the error by referring to the value output by *ErrorID* (Error Code).

● **Timing Chart When Error Occurs**

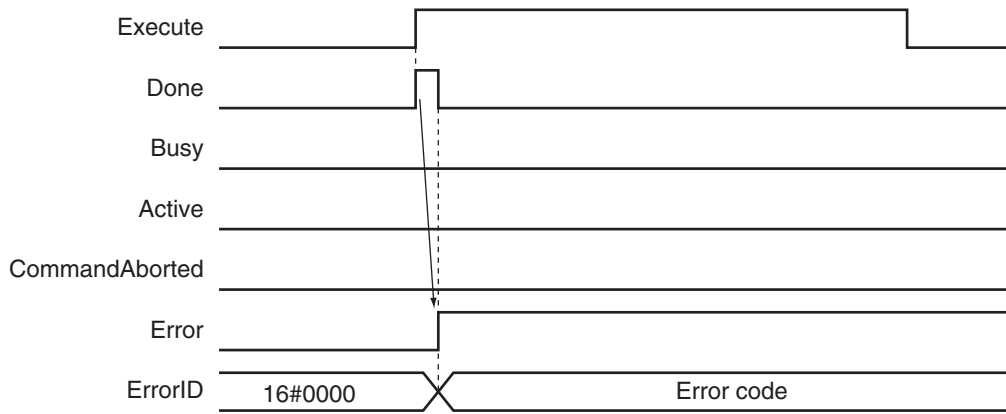

● **Error Codes**

Refer to the *NJ/NX-series Troubleshooting Manual (Cat. No. W503)* for instruction errors.

# MC\_MoveFeed

The MC\_MoveFeed instruction performs positioning for the specified travel distance from the position where an external device triggers an interrupt input.

Interrupt feeding is possible for absolute positioning, relative positioning, and velocity control.

Instruction	Name	FB/ FUN	Graphic expression	ST expression
MC_MoveFeed	Interrupt Feeding	FB		<pre>MC_MoveFeed_instance (   Axis :=parameter,   TriggerInput :=parameter,   TriggerVariable :=parameter,   Execute :=parameter,   WindowOnly :=parameter,   FirstPosition :=parameter,   LastPosition :=parameter,   ReferenceType :=parameter,   Position :=parameter,   Velocity :=parameter,   Acceleration :=parameter,   Deceleration :=parameter,   Jerk :=parameter,   Direction :=parameter,   MoveMode :=parameter,   FeedDistance :=parameter,   FeedVelocity :=parameter,   BufferMode :=parameter,   ErrorDetect :=parameter,   Done =&gt;parameter,   InFeed =&gt;parameter,   Busy =&gt;parameter,   Active =&gt;parameter,   CommandAborted =&gt;parameter,   Error =&gt;parameter,   ErrorID =&gt;parameter );</pre>

## Variables

### Input Variables

Name	Meaning	Data type	Valid range	De- fault	Description
Execute	Execute	BOOL	TRUE or FALSE	FALSE	The instruction is executed when the value of this variable changes to TRUE.
WindowOnly	Window Only	BOOL	TRUE or FALSE	FALSE	Specify whether to enable or disable the window.

Name	Meaning	Data type	Valid range	Default	Description
FirstPosition	First Position	LREAL	Negative number, positive number, or 0	0	Specify the position where latching is enabled. The unit is command units. *1
LastPosition	Last Position	LREAL	Negative number, positive number, or 0	0	Specify the position where latching is disabled. The unit is command units. *1
Reference-Type	Position Type Selection	_eMC_REFERENCE_TYPE	1: _mcFeedback	1*2	Specify the position type. 1: Actual position (value obtained in the same task period*3)
Position	Target Position	LREAL	Negative number, positive number, or 0	0	If <i>MoveMode</i> is set to <b>0: Absolute positioning</b> , specify the absolute target positions on the absolute coordinate. If <i>MoveMode</i> is set to <b>1: Relative positioning</b> , specify the travel distance. If <i>MoveMode</i> is set to <b>2: Velocity control</b> , specification is not necessary. The unit is command units. *1
Velocity	Target Velocity	LREAL	Positive number*4	0	Specify the target velocity. The unit is command units/s. *1
Acceleration	Acceleration Rate	LREAL	Non-negative number	0	Specify the acceleration rate. The unit is command units/s <sup>2</sup> . *1
Deceleration	Deceleration Rate	LREAL	Non-negative number	0	Specify the deceleration rate. The unit is command units/s <sup>2</sup> . *1
Jerk	Jerk	LREAL	Non-negative number	0	Specify the jerk. The unit is command units/s <sup>3</sup> . *1
Direction	Direction	_eMC_DIRECTION	0: _mcPositiveDirection 1: _mcShortestWay 2: _mcNegativeDirection 3: _mcCurrentDirection 4: _mcNoDirection	0*2	Specify the direction of rotation when <i>MoveMode</i> is set to <b>0: Absolute positioning</b> *5 and when the Count Mode is <b>Rotary Mode</b> . 0: Positive direction 1: Shortest way 2: Negative direction 3: Current direction 4: No direction specified
MoveMode	Travel Mode	_eMC_MOVE_MODE	0: _mcAbsolute 1: _mcRelative 2: _mcVelocity	0*2	Select the travel method. 0: Absolute positioning 1: Relative positioning 2: Velocity control

Name	Meaning	Data type	Valid range	De- fault	Description
FeedDistance	Feed Dis- tance	LREAL	Negative number, positive number, or 0	0	Specify the travel distance after the interrupt feed input. Specify a positive value to feed in the same direction as the axis was moving before the interrupt input and specify a negative val- ue to feed in the opposite direc- tion. The unit is command units. *1
FeedVelocity	Feed Ve- locity	LREAL	Positive number	0	Specify the target travel velocity after the interrupt feed input. The unit is command units/s. *1
BufferMode	Buffer Mode Se- lection	_eMC_BUF- FER_MODE	0: _mcAborting 1: _mcBuffered	0*2	Specify the behavior when execu- ting more than one motion in- struction. 0: Aborting 1: Buffered
ErrorDetect	Error De- tection Se- lection	BOOL	TRUE or FALSE	FALSE	Specify whether to detect an er- ror when there is no interrupt feed input. TRUE: Detect errors. FALSE: Do not detect errors.

\*1. Refer to *Unit Conversion Settings* in the *NJ/NX-series CPU Unit Motion Control User's Manual (Cat. No. W507)* for information on command units.

\*2. The default value for an enumeration variable is actually not the number, but the enumerator.

\*3. The task period is the primary period if the task is the primary periodic task and the task period of the priority-5 periodic task if the task is the priority-5 periodic task.

\*4. A value of 0 can be set if *MoveMode* is set to **2: Velocity control**.

\*5. The axis moves to the specified position when *MoveMode* is set to **0: Absolute positioning** and when the Count Mode is **Linear Mode**.

When *MoveMode* is set to **1: Relative positioning**, the travel direction is determined by the sign of the position.

**1: Shortest way** and **4: No direction specified** cannot be selected when *MoveMode* is set to **2: Velocity control**, regardless of the Counter Mode.

## Output Variables

Name	Meaning	Data type	Valid range	Description
Done	Done	BOOL	TRUE or FALSE	TRUE when the instruction is completed.
InFeed	Feeding	BOOL	TRUE or FALSE	TRUE while feeding after receiving a latch input.
Busy	Executing	BOOL	TRUE or FALSE	TRUE when the instruction is acknowledged.
Active	Controlling	BOOL	TRUE or FALSE	TRUE when the axis is being controlled.
CommandAborted	Command Aborted	BOOL	TRUE or FALSE	TRUE when the instruction is aborted.
Error	Error	BOOL	TRUE or FALSE	TRUE while there is an error.



Name	Meaning	Data type	Valid range	Description
ErrorID	Error Code	WORD	*1	Contains the error code when an error occurs. A value of 16#0000 indicates normal execution.

\*1. The upper four digits of the event code give the error code for ErrorID. Refer to the *NJ/NX-series Troubleshooting Manual (Cat. No. W503)* for the event codes.

### ● Output Variable Update Timing

Name	Timing for changing to TRUE	Timing for changing to FALSE
Done	When the instruction is completed.	<ul style="list-style-type: none"> <li>When <i>Execute</i> is TRUE and changes to FALSE.</li> <li>After one period when <i>Execute</i> is FALSE.</li> </ul>
Busy	When <i>Execute</i> changes to TRUE.	<ul style="list-style-type: none"> <li>When <i>Done</i> changes to TRUE.</li> <li>When <i>Error</i> changes to TRUE.</li> <li>When <i>CommandAborted</i> changes to TRUE.</li> </ul>
Active	When the instruction is started.	<ul style="list-style-type: none"> <li>When <i>Done</i> changes to TRUE.</li> <li>When <i>Error</i> changes to TRUE.</li> <li>When <i>CommandAborted</i> changes to TRUE.</li> </ul>
InFeed	When feeding is started by the interrupt input. *1	<ul style="list-style-type: none"> <li>When <i>Done</i> changes to TRUE.</li> <li>When <i>Error</i> changes to TRUE.</li> <li>When <i>CommandAborted</i> changes to TRUE.</li> </ul>
CommandAborted	<ul style="list-style-type: none"> <li>When this instruction is aborted because another motion control instruction was executed with the Buffer Mode set to <b>Aborting</b>.</li> <li>When this instruction is canceled due to an error.</li> <li>When this instruction is executed while there is an error.</li> <li>When you start this instruction during MC_Stop instruction execution.</li> </ul>	<ul style="list-style-type: none"> <li>When <i>Execute</i> is TRUE and changes to FALSE.</li> <li>After one period when <i>Execute</i> is FALSE.</li> </ul>
Error	When there is an error in the execution conditions or input parameters for the instruction.	When the error is cleared.

\*1. There may be a delay of up to several task periods from when the interrupt input turns ON until *InFeed* changes to TRUE.  
The task period is the primary period if the task is the primary periodic task and the task period of the priority-5 periodic task if the task is the priority-5 periodic task.

## In-Out Variables

Name	Meaning	Data type	Valid range	Description
Axis	Axis	_sAXIS_REF	---	Specify the axis. *1
TriggerInput	Trigger Input Condition	_sTRIGGER_REF	---	Set the trigger condition. *2
TriggerVariable	Trigger Variable	BOOL	TRUE or FALSE	Specify a trigger input variable when the Controller Mode is specified for the trigger mode.

\*1. Specify a user-defined Axis Variable that was created in the Axis Basic Settings of the Sysmac Studio (default: MC\_Axis\*) or a system-defined axis variable name (\_MC\_AX[\*], \_MC1\_AX[\*], or \_MC2\_AX[\*]).  
If you use Sysmac Studio version 1.29 or higher, you can specify the system-defined axis variable name for AT specification of a user-defined variable. This will allow you to specify the user-defined variable.

If you use Sysmac Studio version 1.28 or lower, do not specify any user-defined variable created in the variable table.

- \*2. Define a user-defined variable with a data type of `_sTRIGGER_REF`.

### ● `_sTRIGGER_REF`

Name	Meaning	Data type	Valid range	Function
Mode	Mode	<code>_eMC_TRIGGER_MODE</code>	0: <code>_mcDrive</code> 1: <code>_mcController</code>	Specify the trigger mode. 0: Drive Mode 1: Controller Mode
LatchID	Latch ID Selection	<code>_eMC_TRIGGER_LATCH_ID</code>	0: <code>_mcLatch1</code> 1: <code>_mcLatch2</code>	Specify which of the two latch functions to use in <b>Drive Mode</b> . 0: Latch 1 1: Latch 2
InputDrive	Trigger Input Signal	<code>_eMC_TRIGGER_INPUT_DRIVE</code>	0: <code>_mcEncoderMark</code> 1: <code>_mcEXT</code>	Specify the Servo Drive trigger signal to use in <b>Drive Mode</b> . 0: Z-phase signal 1: External input

## Function

- When *Execute* changes to TRUE, the axis travels with absolute travel, relative travel, or velocity control depending on the *MoveMode* setting.
- The target position is set in *Position* (Target Position) for absolute travel. The target distance is set in *Position* (Target Distance) for relative travel.  
Both travel methods use *Velocity* (Target Velocity) for travel operation.
- Relative positioning is performed with *FeedVelocity* from the actual position where the external input turned ON during travel for the feed distance that is specified with *FeedDistance*.
- If no interrupt signal is input before the axis reaches the default target position during interrupt feeding in absolute or relative travel mode, the axis stops at the target position.  
You can specify whether there is an error output when the axis stops for *ErrorDetect* (i.e., when there is no interrupt input.) If you specify an error output, *CommandAborted* changes to TRUE, and *Busy* (Executing) and *Active* (Controlling) change to FALSE.
- To use interrupt masks, change *WindowOnly* to TRUE, then specify *FirstPosition* and *LastPosition*.  
Interrupt feeding is performed for the first interrupt signal generated by the actual position between the *FirstPosition* and the *LastPosition*.



### Precautions for Correct Use

- Feeding after the interrupt is performed as a relative movement for the distance that is specified with *FeedDistance*. If a positive value is specified for *FeedDistance*, feeding is performed in the same direction as before the interrupt input, and if a negative value is specified, feeding is performed in the opposite direction.
- The setting of the **Operation Selection at Reversing** axis parameter is used for the acceleration and deceleration rates when reversing to feed.
- If an underflow or overflow would occur for the position after interrupt feeding, an error occurs when the interrupt input is received. If an interrupt input is received after there is an overflow or underflow, an axis error will still occur.



### Additional Information

Refer to *MC\_MoveAbsolute* on page 3-52 for absolute travel, *MC\_MoveRelative* on page 3-79 for relative travel, *MC\_MoveVelocity* on page 3-87 for velocity control, and *WindowOnly* on page 3-117 for *WindowOnly*.

## ● Mapping Data Objects

You must map the following object data when the *MC\_MoveFeed* (Interrupt Feeding) instruction is executed with *Mode* set to **Drive Mode**.

Mapping is performed in the **Detailed Settings** Area of the Axis Basic Settings Display of the Sysmac Studio.

- Touch probe function (60B8 hex)
- Touch probe status (60B9 hex)
- Touch probe pos1 pos value (60BA hex)
- Touch probe pos2 pos value (60BC hex)

If even one of the required objects is not set, a Process Data Object Setting Missing error (error code: 3461 hex) occurs.

For details on mapping data objects, refer to *2-3 PDO Mapping* on page 2-39 and to the *NJ/NX-series CPU Unit Motion Control User's Manual (Cat. No. W507)*.

Refer to *I/O Entry Mappings* in the *NX-series Position Interface Units User's Manual (Cat. No. W524)* for information on using the NX-series Position Interface Units.

## Instruction Details

This section describes the instruction in detail.

### ● Specifying Axis

- Specify the axis for which to latch the position to *Axis*.

### ● Trigger Input Condition

Select the trigger conditions with *Mode*, *LatchID*, and *InputDrive* of the *TriggerInput* (Trigger Input Conditions) variable.

#### Mode

- The *Mode* can be set to **Drive Mode** to specify a signal from the Servo Drive or NX-series Pulse Output Unit as the trigger, or to **Controller Mode** to specify a trigger with *TriggerVariable*.
- The trigger occurs on the rising edge of the trigger signal. The axis position is latched on the first trigger (FALSE to TRUE) after the *MC\_TouchProbe* instruction is executed.
- While this instruction is *Busy* (Executing), a change in *TriggerVariable* is taken as a trigger even if *Execute* is FALSE.

#### Drive Mode

For trigger detection and latching of the actual position, the latched actual position is more precise in **Drive Mode** (which is a Servo Drive function) than it is in **Controller Mode**.

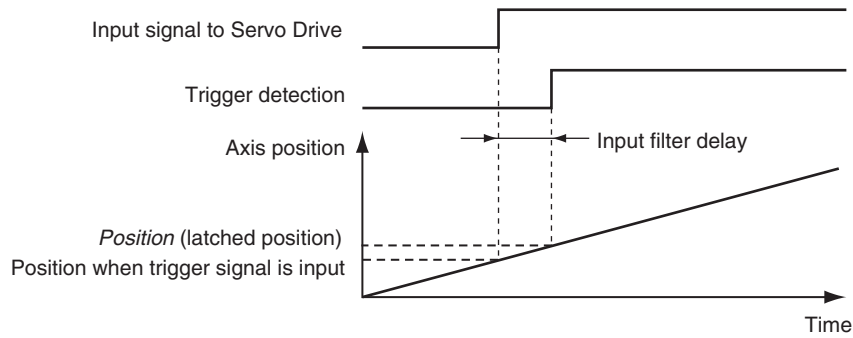

#### Precautions for Correct Use

- When using **Drive Mode**, make sure that you connect the latch signal to the *LatchID* that you are going to use.
- The width of the latch signal depends on the performance of the Servo Drive or NX-series Pulse Output Unit and other factors.
- You must map the following object data when the MC\_MoveFeed (Interrupt Feeding) instruction is executed with *InputDrive* set to **Drive Mode**.  
 Touch probe function (60B8 hex), Touch probe status (60B9 hex), Touch probe pos1 pos value (60BA hex), and Touch probe pos2 pos value (60BC hex)  
 If even one of the required objects is not set, a Process Data Object Setting Missing error (error code: 3461 hex) occurs.  
 For details on mapping object data, refer to *2-3 PDO Mapping* on page 2-39 and to the *NJ/NX-series CPU Unit Motion Control User's Manual (Cat. No. W507)*.

#### Controller Mode

- You can specify a BOOL variable in the **Controller Mode**.
- Use *TriggerVariable* to specify the BOOL variable that you want to use as a trigger.
- The **Controller Mode** causes a longer delay compared to the **Drive Mode**. This is due to the I/O refresh delay that occurs when the trigger input signal is updated in the BOOL variable.

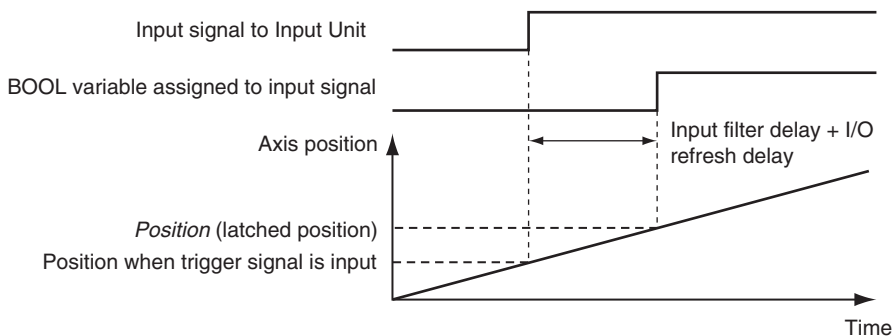

#### Precautions for Correct Use

If you use **Controller Mode**, the latch is performed each task period. Therefore, the trigger variable must remain TRUE for at least one task period. Also, one task period is required between when the trigger variable changes to TRUE and the MC Function Module processes the latch. Here, the task period is the primary period if the task is the primary periodic task and the task period of the priority-5 periodic task if the task is the priority-5 periodic task.

#### LatchID

- Specify which of the two to use with *LatchID*. You can use only one of the latches with any one axis.
- *LatchID* indicates latch circuit 1 and latch circuit 2 in the Servo Drive or NX-series Pulse Output Unit.

For information on *LatchID*, refer to the *NJ/NX-series CPU Unit Motion Control User's Manual (Cat. No. W507)*.

### InputDrive

- You can select `_mcEncoderMark` (Z phase) or `_mcEXT` (External Input) as triggers.
- Select `_mcEncoderMark` (Z phase) to use the Z phase of the Servo Drive or NX-series Pulse Output Unit as the trigger.  
Select `_mcEXT` (external input) to use the external trigger signal of the Servo Drive or NX-series Pulse Output Unit as the trigger.
- For an OMRON 1S-series Servo Drive, there are two options for `_mcEXT`: Ext1, and Ext2. For an OMRON G5-series Servo Drive, there are three options for `_mcEXT`: Ext1, Ext2, and Ext3. Use Sysmac Studio to make the setting.  
The two triggers set in the Servo Drive can have the same setting.
- Refer to the *NX-series Position Interface Units User's Manual (Cat. No. W524)* for information on using the NX-series Pulse Output Unit.

### ● WindowOnly

- *WindowOnly* specifies whether the window is enabled or disabled.
- If you specify *Disable*, triggers are detected for all axis positions.
- If you specify *Enable*, triggers are detected only when the axis position is within the range specified by *FirstPosition* and *LastPosition*.

The following timing chart shows the difference in operation depending on the *WindowOnly* setting.

#### WindowOnly Set to Disable

The axis position when the first trigger occurs after *Execute* changes to TRUE is used as the reference position for the feed distance.

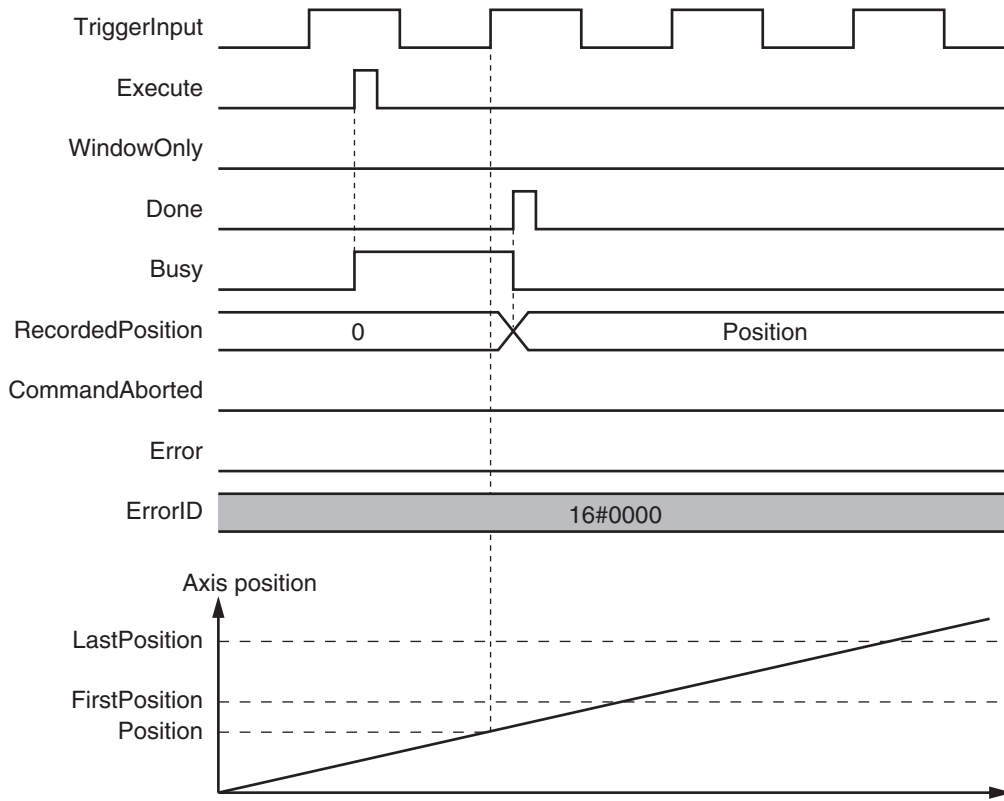

#### WindowOnly Set to Enable

Only trigger inputs within the window are detected to latch the axis position.

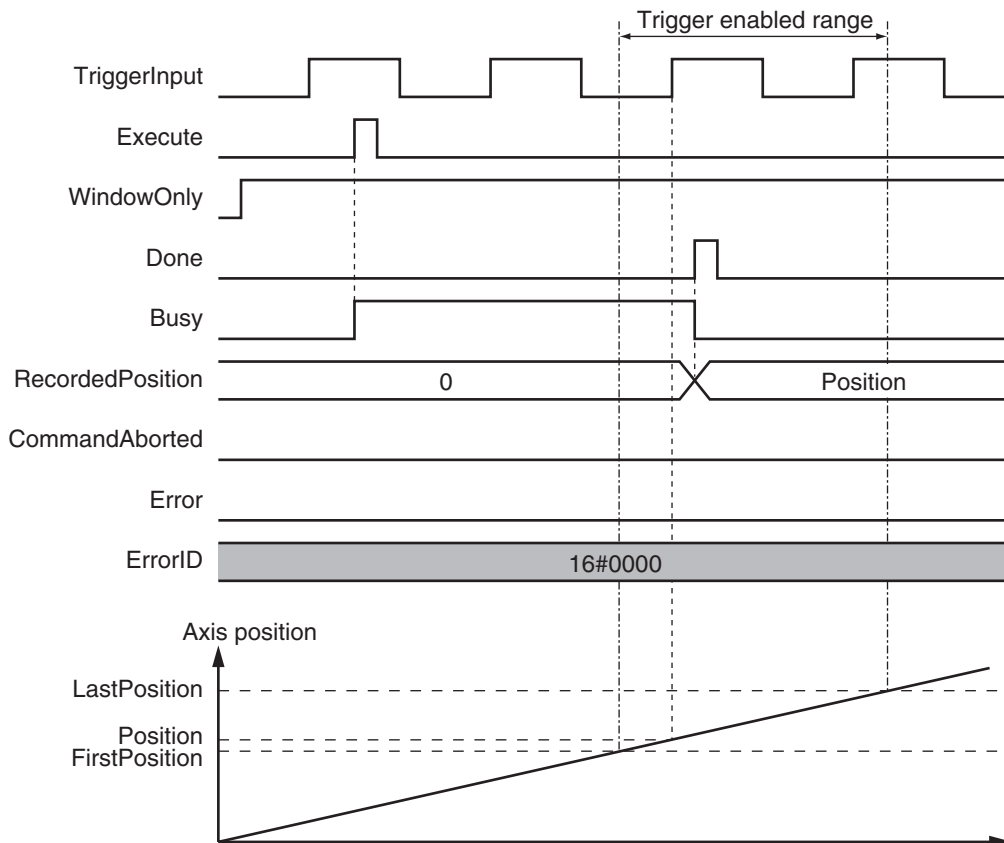



### Precautions for Correct Use

- Latching is not possible at the moment that *WindowOnly* changes to TRUE and until the latch function is activated.
- Time is needed until the latch function is activated. If the effective range for *WindowOnly* is too small, latching is not possible. The range in which latching is possible depends on the performance of the Servo Drive, Encoder Input Terminal, or Position Interface Unit, and on EtherCAT communications.

The range that is defined by *FirstPosition* and *LastPosition* depends on the Count Mode, as given below.

#### Linear Mode

- *FirstPosition* must be less than or equal to the window range and the window range must be less than or equal to *LastPosition*.
- An error will occur if the *FirstPosition* is greater than the *LastPosition*.
- An error will also occur if a position beyond the position range of **Linear Mode** is specified.
- *FirstPosition* and *LastPosition* are LREAL variables. Do not set them to the same values. Refer to *Treatment of REAL and LREAL Data* on page 1-13 for information on LREAL data.

The window only range in **Linear Mode** is shown below.

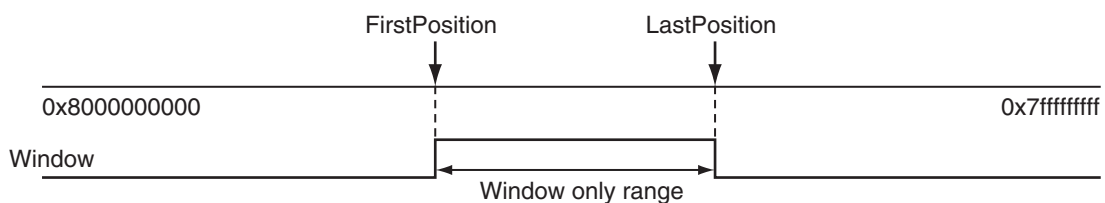

**Note** The window only range can include the *FirstPosition* and *LastPosition*.

#### Rotary Mode

- The *FirstPosition* can be less than, equal to, or greater than the *LastPosition*.
- If the *FirstPosition* is greater than the *LastPosition*, the setting range includes the modulo maximum position and modulo minimum position setting values.
- An error will occur if you specify a value beyond the modulo maximum position and modulo minimum position setting values.

$FirstPosition \leq LastPosition$

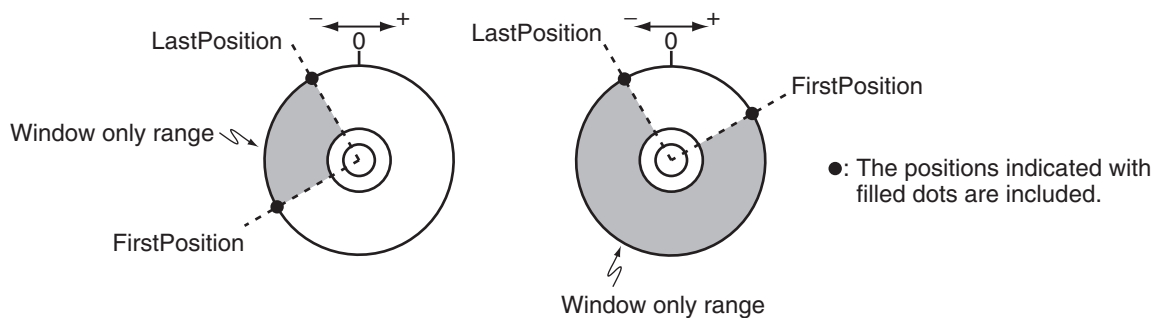

FirstPosition > LastPosition

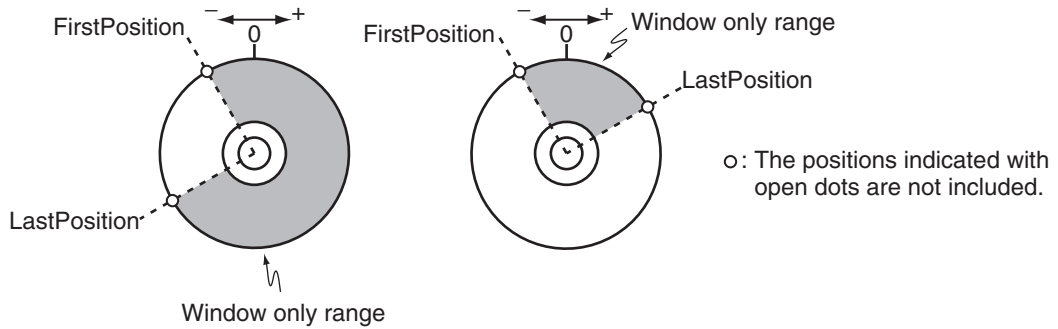

### ● ReferenceType (Position Type Selection)

The position type is as follows:

- `_mcFeedback`: Value obtained in the same task period

The actual position of the master axis that was obtained in the same task period is used.

Here, the task period is the primary period if the task is the primary periodic task and the task period of the priority-5 periodic task if the task is the priority-5 periodic task.

### ● FeedDistance

Specify a positive value for *FeedDistance* to perform feed in the same direction as the motion before the interrupt input. Specify a negative value for *FeedDistance* to perform feed in the opposite direction as the motion before the interrupt input.

For example, if you specify a positive value for *FeedDistance* when the motion was in the negative direction before the interrupt input, feeding is performed in the negative direction. If you specify a negative value for *FeedDistance*, feeding is performed in the positive direction.

## Timing Charts

- *Busy* (Executing) changes to TRUE at the same time as *Execute* changes to TRUE. *Active* (Controlling) changes to TRUE in the next period.
- After an interrupt input, *InFeed* changes to TRUE and when *FeedDistance* is reached and positioning is completed, *Done* changes to TRUE.
- If another instruction aborts this instruction, *CommandAborted* changes to TRUE and *Busy* (Executing) and *Active* (Controlling) change to FALSE.



● When *MoveMode* (Travel Mode) is *\_mcAbsolute* or *\_mcRelative*

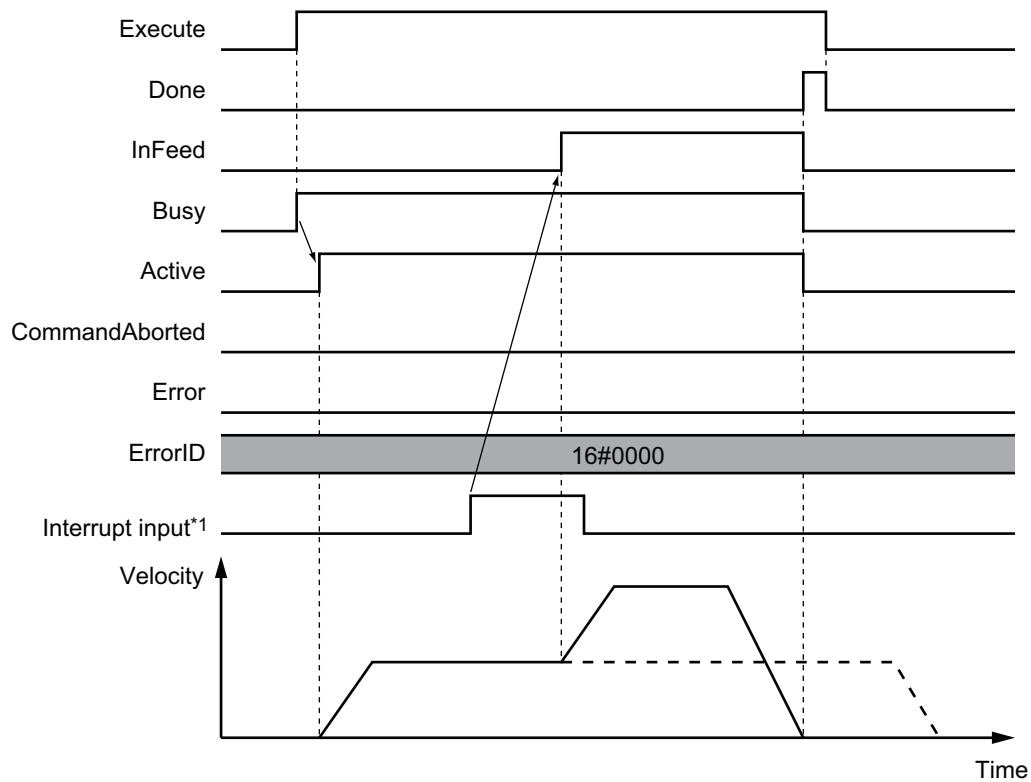

\*1. There may be a delay of up to several control periods from when the interrupt input turns ON until *InFeed* changes to TRUE.



#### Additional Information

Acceleration or deceleration to interrupt feeding is performed according to the *Acceleration* (Acceleration Rate) or *Deceleration* (Deceleration Rate) input variable.

● **When *MoveMode* (Travel Mode) is *\_mcVelocity***

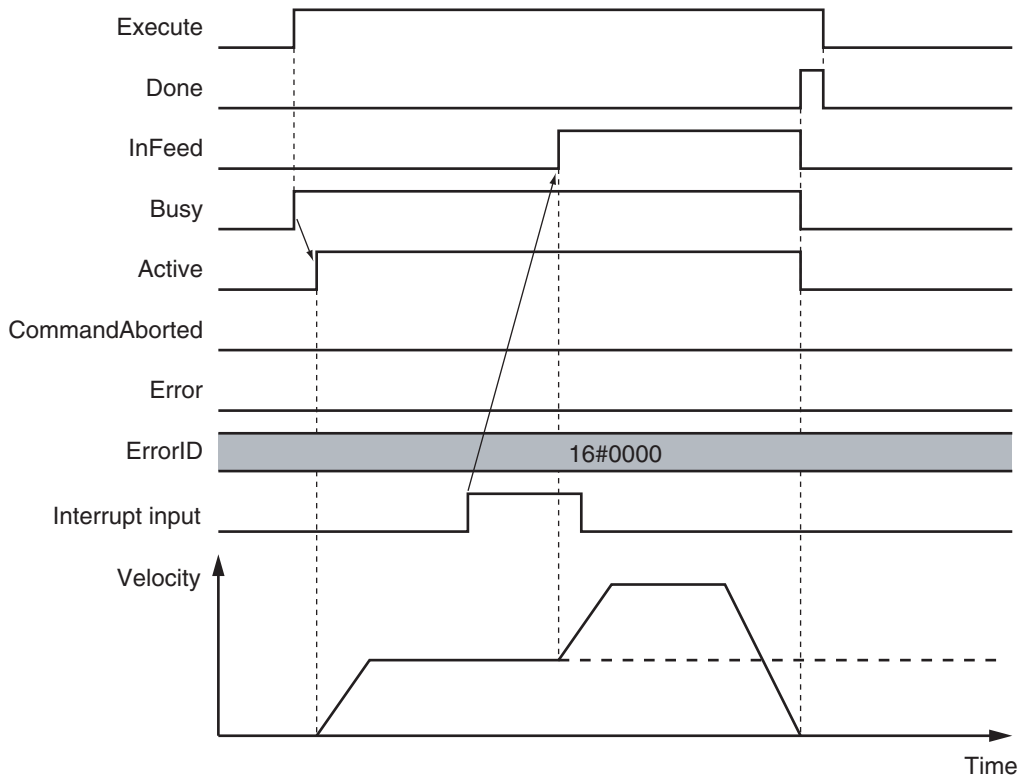

● **Operation Selection at Reversing Axis Parameter**

When feeding reverses its direction after the interrupt input, operation follows the **Operation Selection at Reversing** axis parameter

**When Motion Variable Is 0 (Decelerate to a Stop After Reversing)**

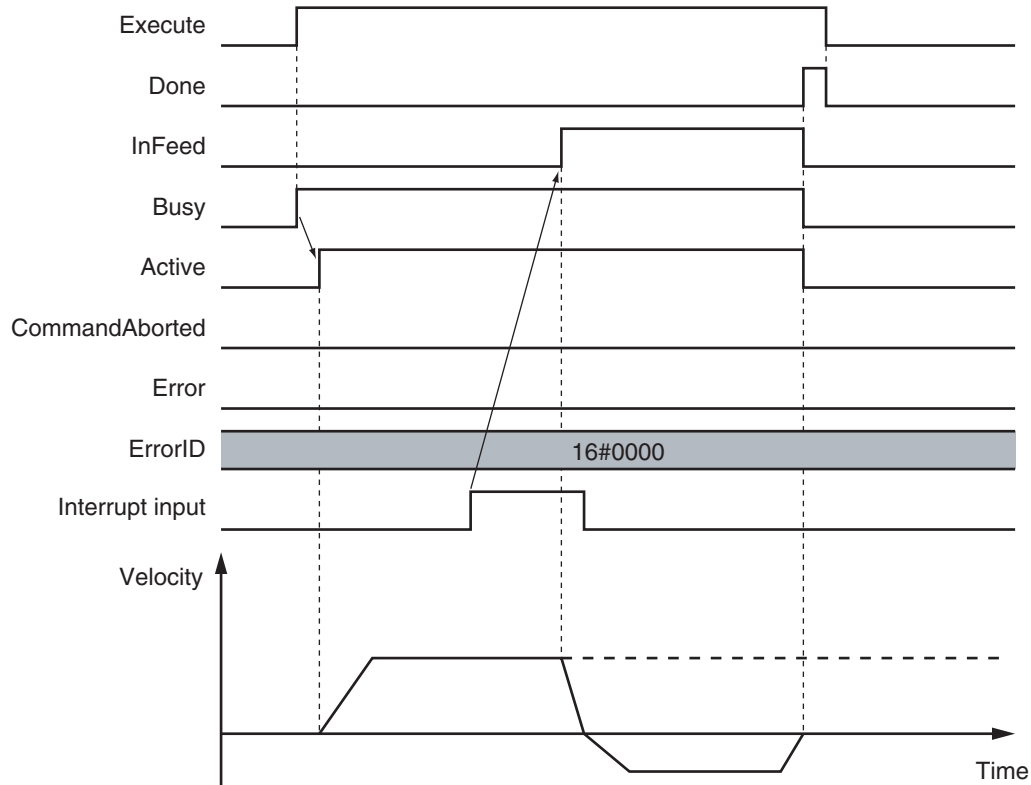

**Additional Information**

The deceleration rate when the axis reverses after an interrupt input follows the *Deceleration* (Deceleration Rate) input variable.

**When Motion Variable Is 1 (Stop Immediately After Reversing)**

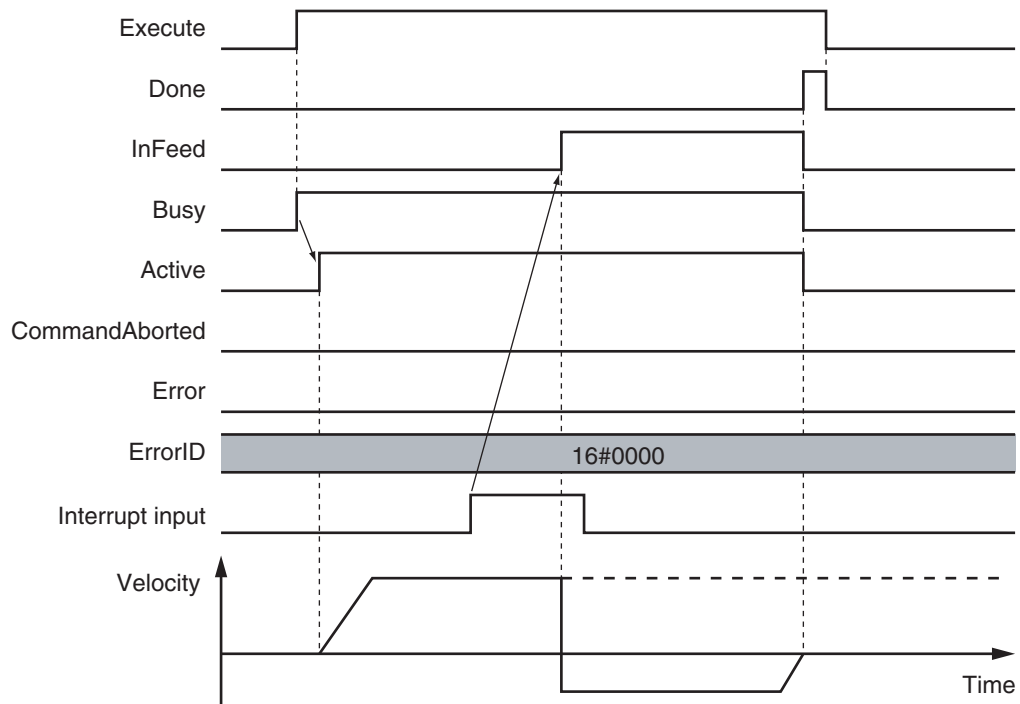

● When *MoveMode* (Travel Mode) is *\_mcAbsolute* and an Interrupt Input Is Not Received

When *ErrorDetect* (Error Detection Selection) Is FALSE

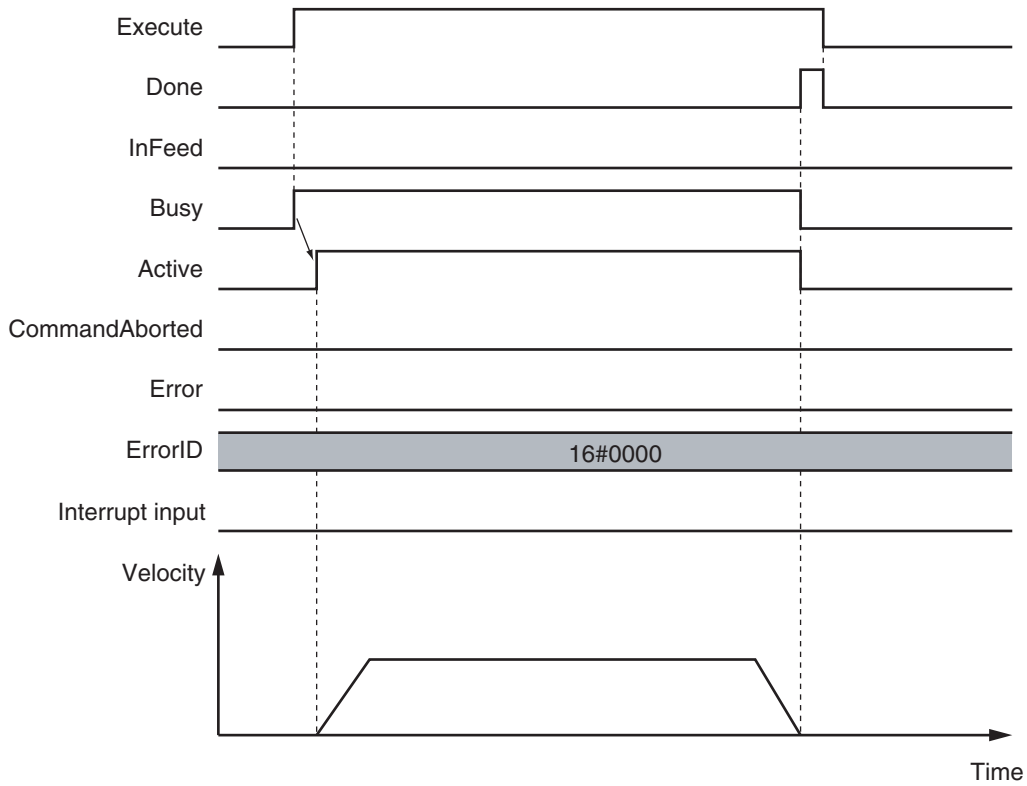

When *ErrorDetect* (Error Detection Selection) Is TRUE

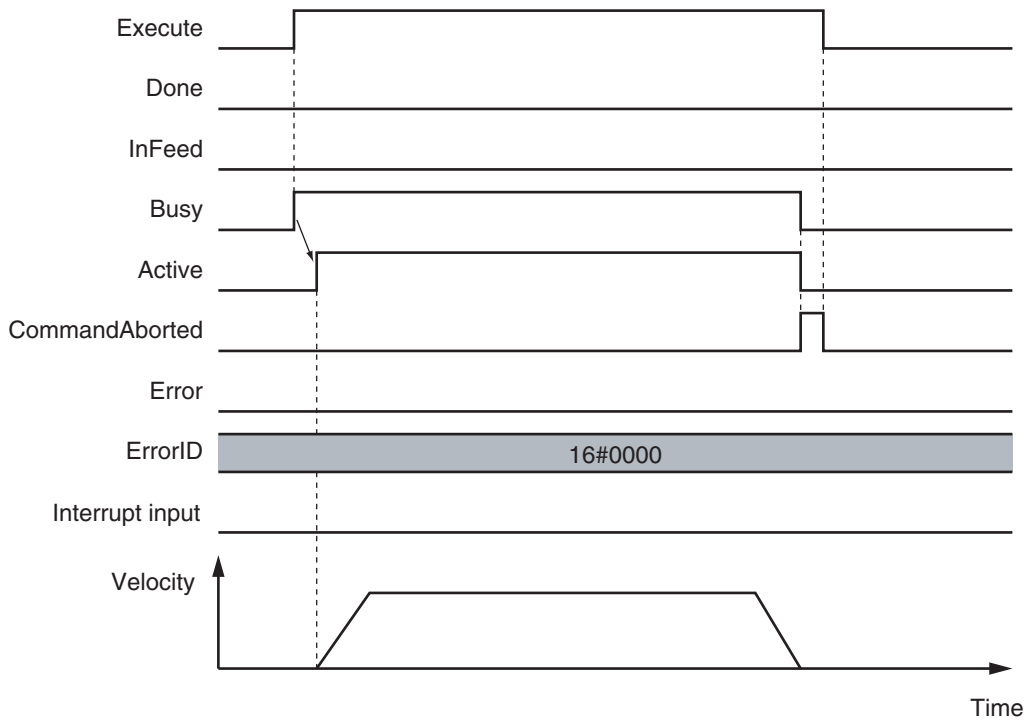

### ● When *WindowOnly* Is TRUE

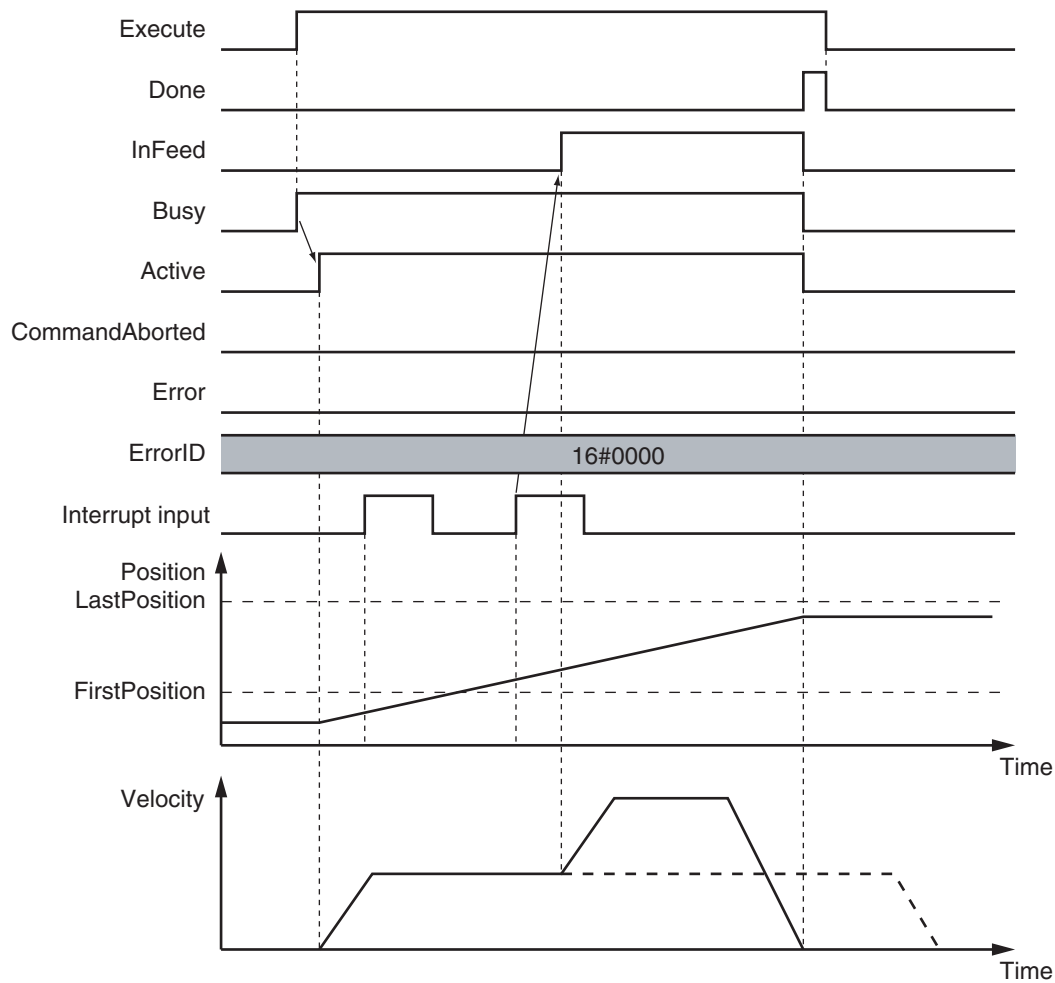

## Re-execution of Motion Control Instructions

This instruction cannot be re-executed.

A Motion Control Instruction Re-execution Disabled error (error code: 543B hex) occurs if re-execution is attempted.

## Multi-execution of Motion Control Instructions

For details on multi-execution of motion control instructions, refer to the *NJ/NX-series CPU Unit Motion Control User's Manual (Cat. No. W507)*.

### ● Execution during Execution of Other Instructions

You can switch to this instruction or buffer this instruction if you execute it during execution of another instruction.

You can buffer one instruction per axis.

Specify the operation of this instruction using *BufferMode* (Buffer Mode Selection) for multi-execution of instructions.

Buffer Mode Selection	Description
Aborting	Aborts the instruction being executed and switches to this instruction. If the direction of axis motion is reversed by switching instructions, the motion will be reversed according to the <b>Operation Selection at Reversing</b> axis parameter.
Buffered	Buffers this instruction and executes it automatically after the current instruction is completed.

For details on *BufferMode* (Buffer Mode Selection), refer to the *NJ/NX-series CPU Unit Motion Control User's Manual* (Cat. No. W507).

### ● Execution of Other Instructions during Instruction Execution

You can execute another instruction with the Buffer Mode set to **Aborting** during execution of this instruction.

The following will occur if another instruction with the Buffer Mode set to **Buffered** or a **Blending** mode is executed.

- *Error* changes to TRUE in the other instruction. A Motion Control Instruction Multi-execution Disabled error (error code: 543C hex) is output to *ErrorID* (Error Code).
- The MC\_MoveFeed instruction is aborted and *CommandAborted* changes to TRUE.

## Errors

If an error occurs during instruction execution, *Error* will change to TRUE.

You can find out the cause of the error by referring to the value output by *ErrorID* (Error Code).

### ● Timing Chart When Error Occurs

When there is an error, the latch used for the interrupt input for this instruction is disabled.

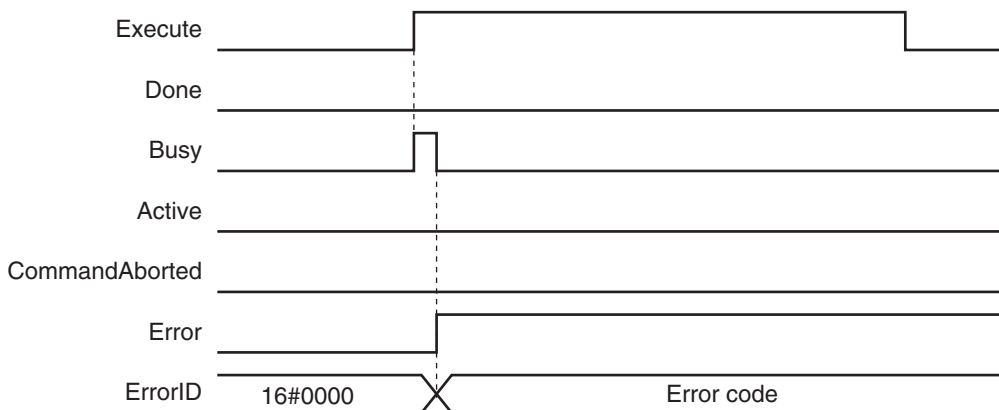

### ● Error Codes

Refer to the *NJ/NX-series Troubleshooting Manual* (Cat. No. W503) for instruction errors.

## Sample Programming

This section shows sample programming where control changes from velocity control to interrupt feeding.

## Parameter Settings

The minimum settings required for this sample programming are given below.

### ● Setting Axis Parameters

#### Axis Types

Axis	Axis Type
Axis 1	Servo axis
Axis 2	Servo axis

#### Count Modes

Axis	Count Mode
Axis 1	Rotary Mode
Axis 2	Linear Mode

#### Ring Counters

Axis	Modulo maximum position	Modulo minimum position
Axis 1	360	0

#### Units of Display

Axis	Unit of Display
Axis 1	degree
Axis 2	mm

## Operation Example

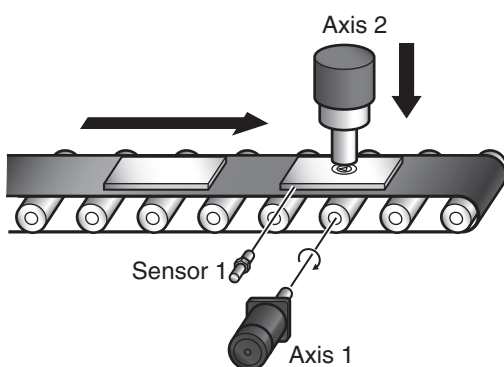

## ● Operation Pattern

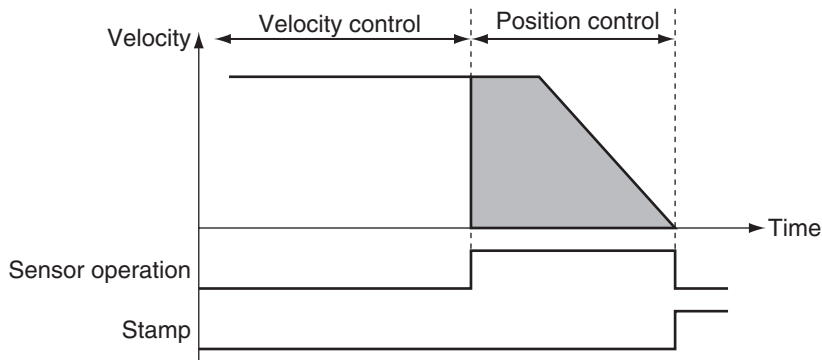

### 1 Conveyor Operation

Axis 1, which moves the conveyor belt, performs velocity control before interrupt feeding.

### 2 Feeding

Sensor 1 is connected to latch 1.

When Sensor1 turns ON, operation changes to feeding and the axis stops at the specified position.

### 3 Pressing the Stamp

When positioning is finished, axis 2 of the stamp moves perpendicularly down at the position determined by absolute positioning to press the stamp. After stamping is performed, axis 2 returns to home.

When the absolute positioning is completed, the axis is immediately returned to home. To enable this, *BufferMode* (Buffer Mode Selection) of the MC\_MoveZeroPosition (High-speed Home) instruction is set to Buffered.

Multi-execution of instructions is performed if the *Active* output from the previous instruction is TRUE.

## Ladder Diagram

### ● Main Variables

Name	Data type	Default	Comment
MC_Axis000	_sAXIS_REF	---	Axis Variable for axis 1.
MC_Axis000.MFaultLvl.Active	BOOL	FALSE	TRUE while there is a minor fault level error for axis 1.
MC_Axis000.Details.Homed	BOOL	FALSE	TRUE when home is defined for axis 1.
MC_Axis001	_sAXIS_REF	---	Axis Variable for axis 2.
MC_Axis001.MFaultLvl.Active	BOOL	FALSE	TRUE while there is a minor fault level error for axis 2.
MC_Axis001.Details.Homed	BOOL	FALSE	TRUE when home is defined for axis 2.



Name	Data type	Default	Comment
TrigRef	_sTRIGGER_REF	---	This is the specified variable for the interrupt input. Latch 1 of the Servo Drive is used in this sample. When the rising edge of the external input for sensor 1 is detected, interrupt feeding is executed.
StartPg	BOOL	FALSE	The Servo is turned ON if this variable is TRUE and EtherCAT process data communications are established.
InitFlag	BOOL	FALSE	This variable indicates if it is necessary to set the input parameters. Input parameters are set when this variable is FALSE. When setting the input parameters is completed, this variable changes to TRUE.

● Timing Chart

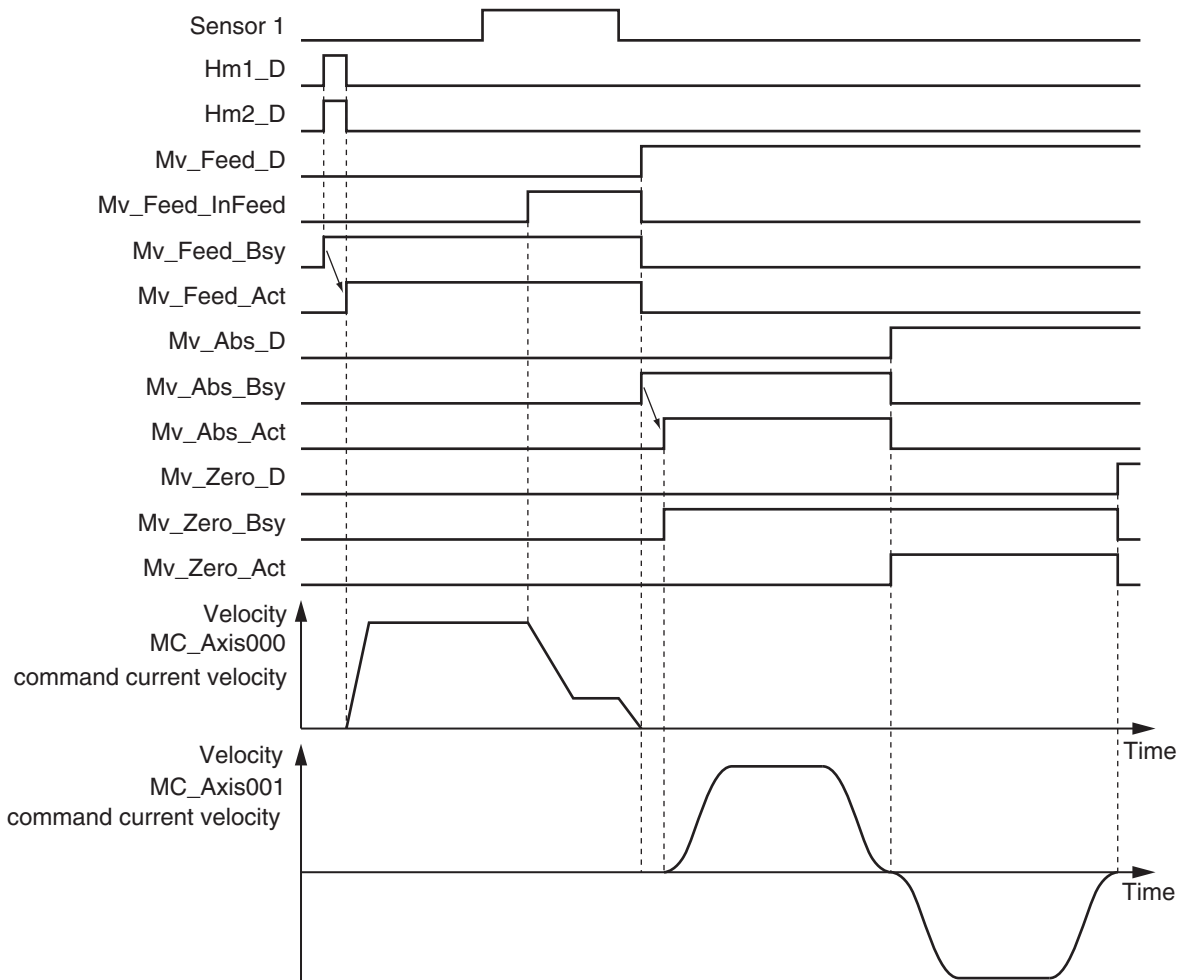

● Sample Programming

If *StartPg* is TRUE, check that the Servo Drives for each axis are ready.

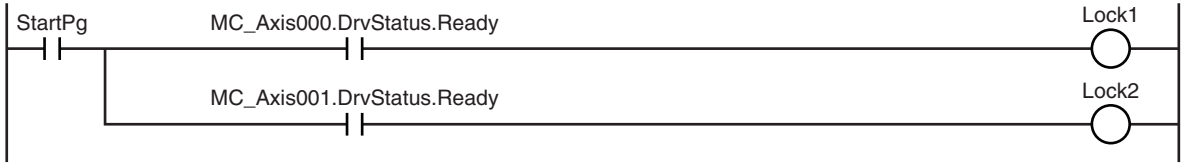

If the Servo Drives are ready, the Servos are turned ON for each axis.

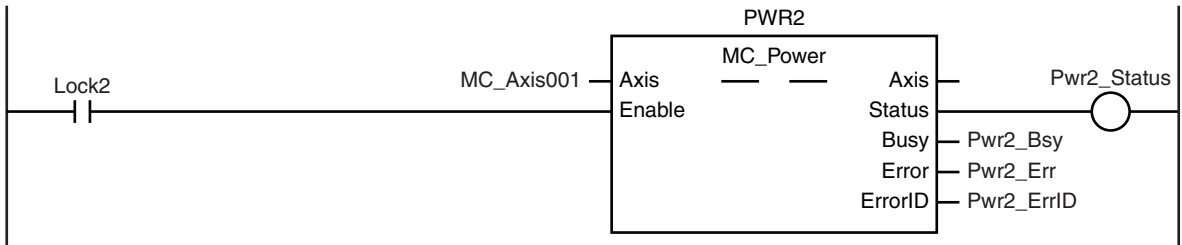
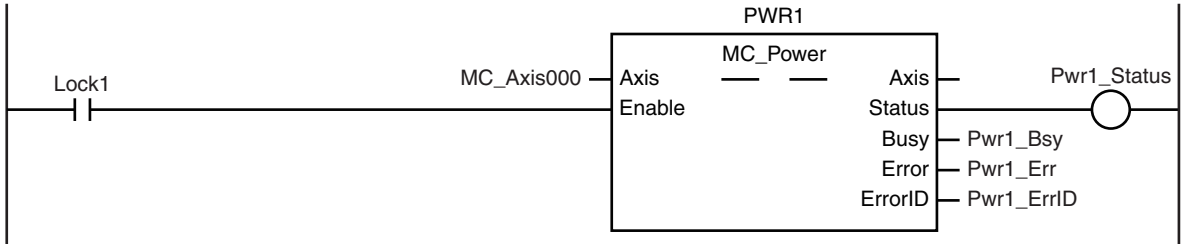

If a minor fault level error occurs for the axis composition, the error handler for the device (FaultHandler) is executed.  
Program the FaultHandler according to the device.

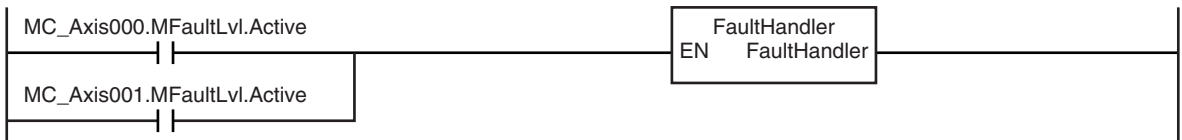

If the Servo is ON for axis 1 and home is not defined, the Home instruction is executed.

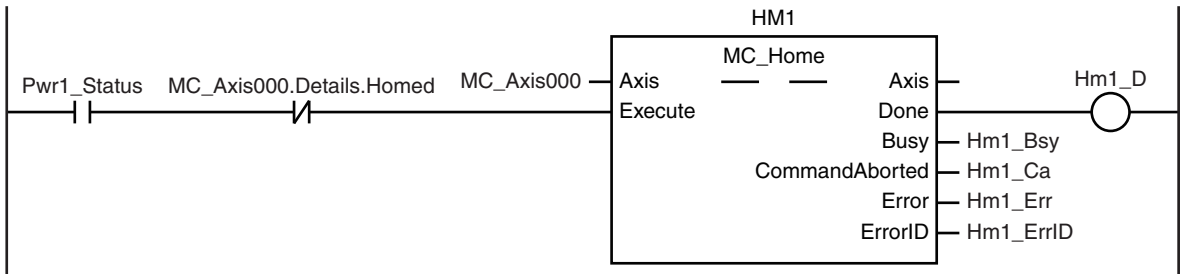

If the Servo is ON for axis 2 and home is not defined, the Home instruction is executed.

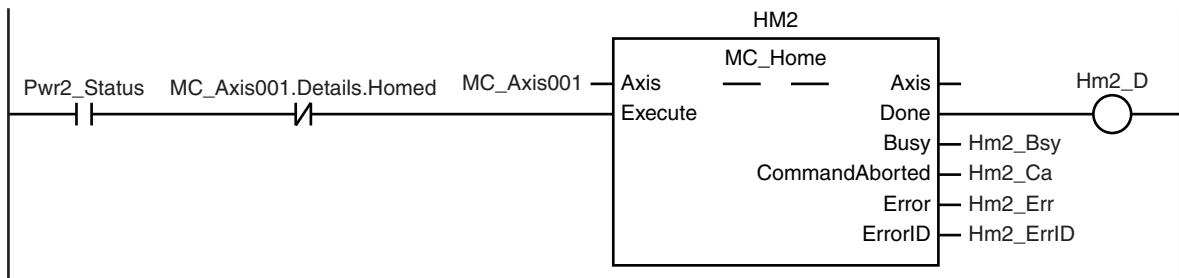

The parameters are set for interrupt feeding, absolute positioning, and high-speed homing.

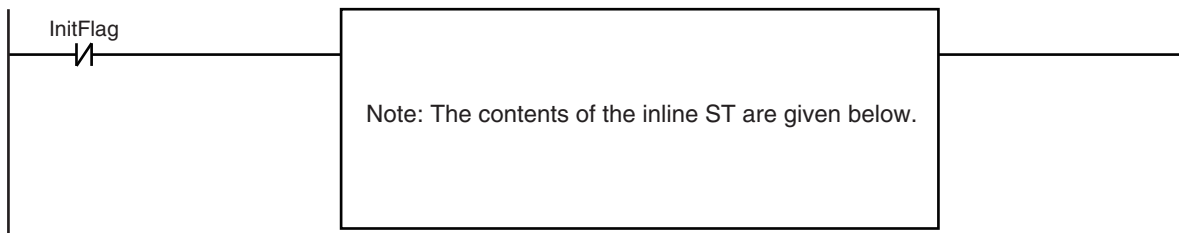

If home is defined for axis 1, interrupt feeding is executed for axis 1.

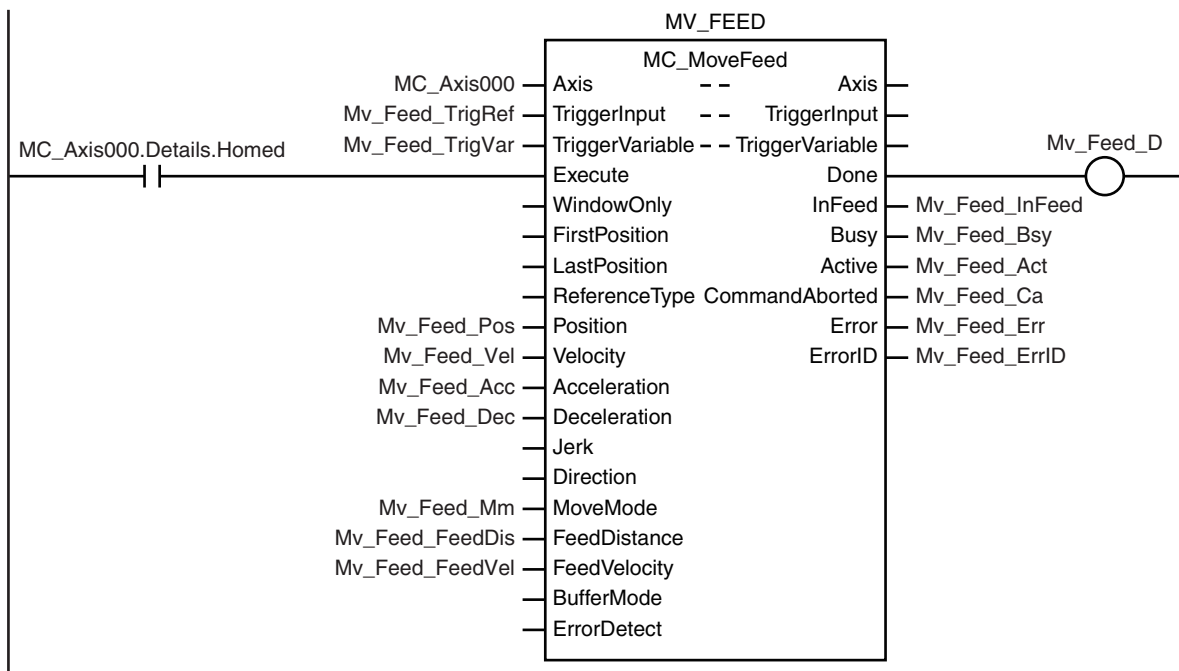

If home is defined for axis 2 and interrupt feeding is completed for axis 1, absolute positioning is performed for axis 2.

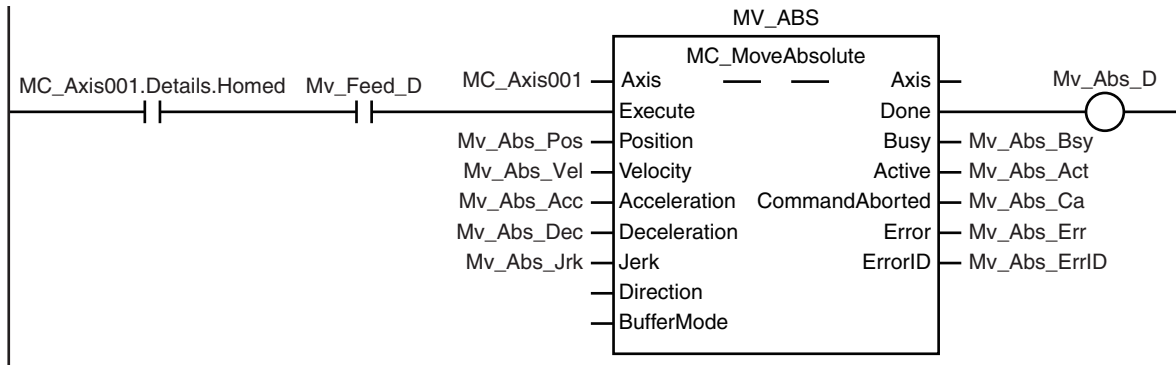

After absolute positioning is completed, the MC\_MoveZeroPosition (High-speed Home) instruction is executed to move to home.

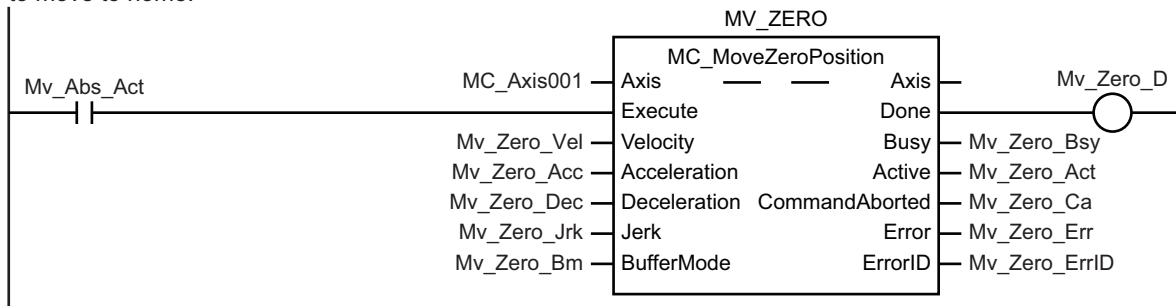

#### Contents of Inline ST

```
// MV_FEED parameters
Mv_Feed_TrigRef.Mode := _eMC_TRIGGER_MODE#_mcDrive;
Mv_Feed_TrigRef.LatchID := _eMC_TRIGGER_LATCH_ID#_mcLatch1;
Mv_Feed_TrigRef.InputDrive := _eMC_TRIGGER_INPUT_DRIVE#_mcEXT;
Mv_Feed_TrigVar := FALSE;
Mv_Feed_Pos := LREAL#2000.0;
Mv_Feed_Vel := LREAL#1000.0;
Mv_Feed_Acc := LREAL#10000.0;
Mv_Feed_Dec := LREAL#10000.0;
Mv_Feed_Mm := _eMC_MOVE_MODE#_mcVelocity;
Mv_Feed_FeedDis := LREAL#500.0;
Mv_Feed_FeedVel := LREAL#500.0;

// MV_ABS parameters
Mv_Abs_Pos := LREAL#1000.0;
Mv_Abs_Vel := LREAL#500.0;
Mv_Abs_Acc := LREAL#10000.0;
Mv_Abs_Dec := LREAL#10000.0;
Mv_Abs_Jrk := LREAL#10000.0;

// MV_ZERO parameters
Mv_Zero_Vel := LREAL#500.0;
Mv_Zero_Acc := LREAL#10000.0;
Mv_Zero_Dec := LREAL#10000.0;
```

```

Mv_Zero_Jrk := LREAL#10000.0;
Mv_Zero_Bm := _eMC_BUFFER_MODE#_mcBuffered;

// Change InitFlag to TRUE after setting the input parameters.
InitFlag := TRUE;

```

## Structured Text (ST)

### ● Main Variables

Name	Data type	Default	Comment
MC_Axis000	_sAXIS_REF	---	Axis Variable for axis 1.
MC_Axis000.MFaultLvl.Active	BOOL	FALSE	TRUE while there is a minor fault level error for axis 1.
MC_Axis000.Details.Homed	BOOL	FALSE	TRUE when home is defined for axis 1.
MC_Axis001	_sAXIS_REF	---	Axis Variable for axis 2.
MC_Axis001.MFaultLvl.Active	BOOL	FALSE	TRUE while there is a minor fault level error for axis 2.
MC_Axis001.Details.Homed	BOOL	FALSE	TRUE when home is defined for axis 2.
TrigRef	_sTRIGGER_REF	---	This is the specified variable for the interrupt input. Latch 1 of the Servo Drive is used in this sample. When the rising edge of the external input for sensor 1 is detected, interrupt feeding is executed.
StartPg	BOOL	FALSE	The Servo is turned ON if this variable is TRUE and EtherCAT process data communications are established.
InitFlag	BOOL	FALSE	This variable indicates if it is necessary to set the input parameters. Input parameters are set when this variable is FALSE. When setting the input parameters is completed, this variable changes to TRUE.
Hm1_Ex	BOOL	FALSE	The HM1 instance of MC_Home is executed when this variable changes to TRUE.
Hm2_Ex	BOOL	FALSE	The HM2 instance of MC_Home is executed when this variable changes to TRUE.
Mv_Feed_Ex	BOOL	FALSE	The MV_FEED instance of MC_MoveFeed is executed when this variable changes to TRUE.
Mv_Abs_Ex	BOOL	FALSE	The MV_ABS instance of MC_MoveAbsolute is executed when this variable changes to TRUE.
Mv_Zero_Ex	BOOL	FALSE	The MV_ZERO instance of MC_MoveZeroPosition is executed when this variable changes to TRUE.

## ● Timing Chart

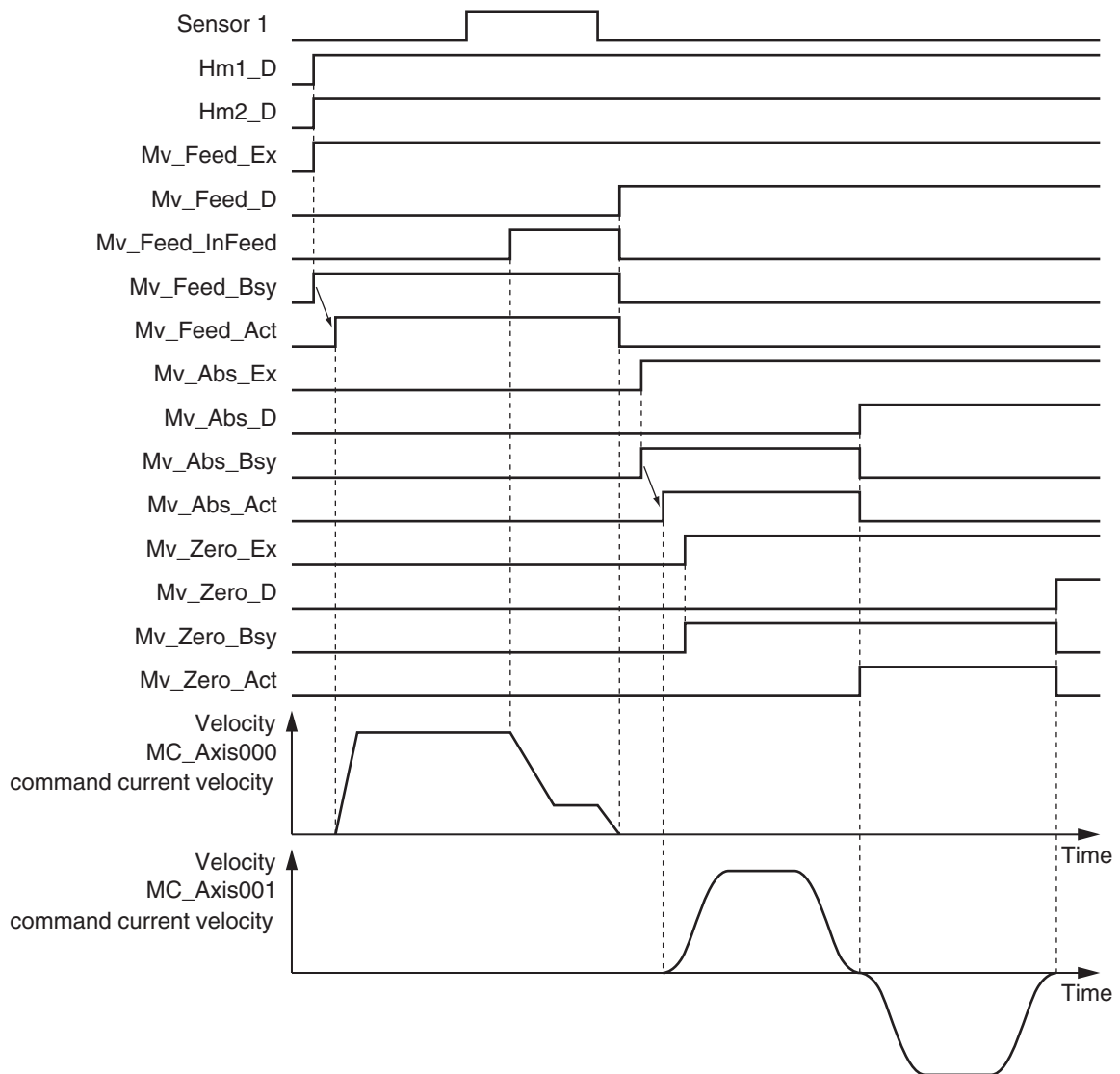

## ● Sample Programming

```
// Processing when input parameters are not set
IF InitFlag=FALSE THEN

  // MV_FEED parameters
  Mv_Feed_TrigRef.Mode := _eMC_TRIGGER_MODE#_mcDrive;
  Mv_Feed_TrigRef.LatchID := _eMC_TRIGGER_LATCH_ID#_mcLatch1;
  Mv_Feed_TrigRef.InputDrive := _eMC_TRIGGER_INPUT_DRIVE#_mcEXT;
  Mv_Feed_TrigVar := FALSE;
  Mv_Feed_Pos := LREAL#2000.0;
  Mv_Feed_Vel := LREAL#1000.0;
  Mv_Feed_Acc := LREAL#10000.0;
  Mv_Feed_Dec := LREAL#10000.0;
  Mv_Feed_Mm := _eMC_MOVE_MODE#_mcVelocity;
  Mv_Feed_FeedDis := LREAL#500.0;
  Mv_Feed_FeedVel := LREAL#500.0;
```

```

// MV_ABS parameters
Mv_Abs_Pos := LREAL#1000.0;
Mv_Abs_Vel := LREAL#500.0;
Mv_Abs_Acc := LREAL#10000.0;
Mv_Abs_Dec := LREAL#10000.0;
Mv_Abs_Jrk := LREAL#10000.0;

// MV_ZERO parameters
Mv_Zero_Vel := LREAL#500.0;
Mv_Zero_Acc := LREAL#10000.0;
Mv_Zero_Dec := LREAL#10000.0;
Mv_Zero_Jrk := LREAL#10000.0;
Mv_Zero_Bm := _eMC_BUFFER_MODE#_mcBuffered;

// Change InitFlag to TRUE after setting the input parameters.
InitFlag := TRUE;

END_IF;

// If StartPg is TRUE and the Servo Drive is ready, the Servo for axis 1 is turned
ON.
// If the Servo Drive is not ready, the Servo is turned OFF.
IF (StartPg=TRUE)
  AND (MC_Axis000.DrvStatus.Ready=TRUE) THEN
  Pwr1_En:=TRUE; // Turn ON the Servo.
ELSE
  Pwr1_En:=FALSE; // Turn OFF the Servo.
END_IF;

// If StartPg is TRUE and the Servo Drive is ready, the Servo for axis 2 is turned
ON.
// If the Servo Drive is not ready, the Servo is turned OFF.
IF (StartPg=TRUE)
  AND (MC_Axis001.DrvStatus.Ready=TRUE) THEN
  Pwr2_En:=TRUE; // Turn ON the Servo for axis 2.
ELSE
  Pwr2_En:=FALSE; // Turn OFF the Servo for axis 2.
END_IF;

// Processing for a minor fault level error
// Program the FaultHandler according to the device.
IF (MC_Axis000.MFaultLvl.Active=TRUE) OR (MC_Axis001.MFaultLvl.Active=TRUE) THEN
  FaultHandler();
END_IF;

// If the Servo is ON for axis 1 and home is not defined, the Home instruction is e

```

```

executed for axis 1.
IF (Pwr1_Status=TRUE) AND (MC_Axis000.Details.Homed=FALSE) THEN
    Hm1_Ex:=TRUE;
END_IF;

// If the Servo is ON for axis 2 and home is not defined, the Home instruction is e
executed for axis 2.
IF (Pwr2_Status=TRUE) AND (MC_Axis001.Details.Homed=FALSE) THEN
    Hm2_Ex:=TRUE;
END_IF;

// After home is defined for axis 1, MC_MoveFeed is executed.
IF MC_Axis000.Details.Homed=TRUE THEN
    Mv_Feed_Ex:=TRUE;
END_IF;

// If home is defined for axis 2 and interrupt feeding is completed for axis 1, abs
olute positioning is performed for axis 2.
IF (MC_Axis001.Details.Homed=TRUE) AND (Mv_Feed_D=TRUE) THEN
    Mv_Abs_Ex := TRUE;
END_IF;

// After MC_MoveAbsolute is started, MC_MoveZeroPosition is executed with multi-exe
cution of instructions.
IF Mv_Abs_Act=TRUE THEN
    Mv_Zero_Ex := TRUE;
END_IF;

// MC_Power for axis 1
PWR1(
    Axis := MC_Axis000,
    Enable := Pwr1_En,
    Status => Pwr1_Status,
    Busy => Pwr1_Bsy,
    Error => Pwr1_Err,
    ErrorID => Pwr1_ErrID
);

// MC_Power for axis 2
PWR2(
    Axis := MC_Axis001,
    Enable := Pwr2_En,
    Status => Pwr2_Status,
    Busy => Pwr2_Bsy,
    Error => Pwr2_Err,
    ErrorID => Pwr2_ErrID
);

```



```

// MC_Home for axis 1
HM1 (
    Axis := MC_Axis000,
    Execute := Hm1_Ex,
    Done => Hm1_D,
    Busy => Hm1_Bsy,
    CommandAborted => Hm1_Ca,
    Error => Hm1_Err,
    ErrorID => Hm1_ErrID
);

// MC_Home for axis 2
HM2 (
    Axis := MC_Axis001,
    Execute := Hm2_Ex,
    Done => Hm2_D,
    Busy => Hm2_Bsy,
    CommandAborted => Hm2_Ca,
    Error => Hm2_Err,
    ErrorID => Hm2_ErrID
);

// MC_MoveFeed
MV_FEED (
    Axis := MC_Axis000,
    TriggerInput := Mv_Feed_TrigRef,
    TriggerVariable := Mv_Feed_TrigVar,
    Execute := Mv_Feed_Ex,
    Position := Mv_Feed_Pos,
    Velocity := Mv_Feed_Vel,
    Acceleration := Mv_Feed_Acc,
    Deceleration := Mv_Feed_Dec,
    MoveMode := Mv_Feed_Mm,
    FeedDistance := Mv_Feed_FeedDis,
    FeedVelocity := Mv_Feed_FeedVel,
    Done => Mv_Feed_D,
    InFeed => Mv_Feed_InFeed,
    Busy => Mv_Feed_Bsy,
    Active => Mv_Feed_Act,
    CommandAborted => Mv_Feed_Ca,
    Error => Mv_Feed_Err,
    ErrorID => Mv_Feed_ErrID
);

// MC_MoveAbsolute
MV_ABS (

```

```
Axis := MC_Axis001,  
Execute := Mv_Abs_Ex,  
Position := Mv_Abs_Pos,  
Velocity := Mv_Abs_Vel,  
Acceleration := Mv_Abs_Acc,  
Deceleration := Mv_Abs_Dec,  
Jerk := Mv_Abs_Jrk,  
Done => Mv_Abs_D,  
Busy => Mv_Abs_Bsy,  
Active => Mv_Abs_Act,  
CommandAborted => Mv_Abs_Ca,  
Error => Mv_Abs_Err,  
ErrorID => Mv_Abs_ErrID  
);  
  
// MC_MoveZeroPosition  
MV_ZERO(  
Axis := MC_Axis001,  
Execute := Mv_Zero_Ex,  
Velocity := Mv_Zero_Vel,  
Acceleration := Mv_Zero_Acc,  
Deceleration := Mv_Zero_Dec,  
Jerk := Mv_Zero_Jrk,  
BufferMode := Mv_Zero_Bm,  
Done => Mv_Zero_D,  
Busy => Mv_Zero_Bsy,  
Active => Mv_Zero_Act,  
CommandAborted => Mv_Zero_Ca,  
Error => Mv_Zero_Err,  
ErrorID => Mv_Zero_ErrID  
);
```

# MC\_Stop

The MC\_Stop instruction decelerates an axis to a stop.

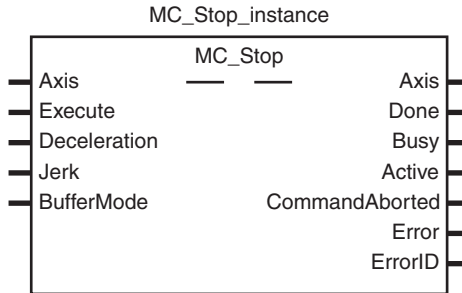
Instruction	Name	FB/ FUN	Graphic expression	ST expression
MC_Stop	Stop	FB		<pre>MC_Stop_instance (   Axis :=parameter,   Execute :=parameter,   Deceleration :=parameter,   Jerk :=parameter,   BufferMode :=parameter,   Done =&gt;parameter,   Busy =&gt;parameter,   Active =&gt;parameter,   CommandAborted =&gt;parameter,   Error =&gt;parameter,   ErrorID =&gt;parameter );</pre>

## Variables

### Input Variables

Name	Meaning	Data type	Valid range	De- fault	Description
Execute	Execute	BOOL	TRUE or FALSE	FALS E	The instruction is executed when the value of this variable changes to TRUE.
Deceleration	Decelera- tion Rate	LREAL	Non-negative number	0	Specify the deceleration rate. The unit is command units/s <sup>2</sup> . <sup>*1</sup>
Jerk	Jerk	LREAL	Non-negative number	0	Specify the jerk. The unit is command units/s <sup>3</sup> . <sup>*1</sup>
BufferMode	Buffer Mode Se- lection	_eMC_BUF- FER_MODE	0: _mcAborting	0 <sup>*2</sup>	Specify the behavior when execut- ing more than one motion instruc- tion. 0: Aborting

\*1. Refer to *Unit Conversion Settings* in the *NJ/NX-series CPU Unit Motion Control User's Manual (Cat. No. W507)* for information on command units.

\*2. The default value for an enumeration variable is actually not the number, but the enumerator.

### Output Variables

Name	Meaning	Data type	Valid range	Description
Done	Done	BOOL	TRUE or FALSE	TRUE when the instruction is completed.

Name	Meaning	Data type	Valid range	Description
Busy	Executing	BOOL	TRUE or FALSE	TRUE when the instruction is acknowledged.
Active	Controlling	BOOL	TRUE or FALSE	TRUE when the axis is being controlled.
CommandAborted	Command Aborted	BOOL	TRUE or FALSE	TRUE when the instruction is aborted.
Error	Error	BOOL	TRUE or FALSE	TRUE while there is an error.
ErrorID	Error Code	WORD	*1	Contains the error code when an error occurs. A value of 16#0000 indicates normal execution.

\*1. The upper four digits of the event code give the error code for ErrorID. Refer to the *NJ/NX-series Troubleshooting Manual (Cat. No. W503)* for the event codes.

### ● Output Variable Update Timing

Name	Timing for changing to TRUE	Timing for changing to FALSE
Done	When the axis decelerates to a stop and the velocity reaches 0.	<ul style="list-style-type: none"> <li>When <i>Execute</i> is TRUE and changes to FALSE.</li> <li>After one period when <i>Execute</i> is FALSE.</li> </ul>
Busy	When <i>Execute</i> changes to TRUE.	<ul style="list-style-type: none"> <li>When <i>Done</i> changes to TRUE.</li> <li>When <i>Error</i> changes to TRUE.</li> <li>When <i>CommandAborted</i> changes to TRUE.</li> </ul>
Active	When the instruction is started.	<ul style="list-style-type: none"> <li>When <i>Done</i> changes to TRUE.</li> <li>When <i>Error</i> changes to TRUE.</li> <li>When <i>CommandAborted</i> changes to TRUE.</li> </ul>
CommandAborted	<ul style="list-style-type: none"> <li>When this instruction is aborted because another MC_Stop instruction was executed with the Buffer Mode set to <b>Aborting</b>.</li> <li>When this instruction is canceled due to an error.</li> <li>When this instruction is executed while there is an error.</li> </ul>	<ul style="list-style-type: none"> <li>When <i>Execute</i> is TRUE and changes to FALSE.</li> <li>After one period when <i>Execute</i> is FALSE.</li> </ul>
Error	When there is an error in the execution conditions or input parameters for the instruction.	When the error is cleared.

## In-Out Variables

Name	Meaning	Data type	Valid range	Description
Axis	Axis	_sAXIS_REF	---	Specifies the axis. *1

\*1. Specify a user-defined Axis Variable that was created in the Axis Basic Settings of the Sysmac Studio (default: MC\_Axis\*) or a system-defined axis variable name (\_MC\_AX[\*], \_MC1\_AX[\*], or \_MC2\_AX[\*]).

If you use Sysmac Studio version 1.29 or higher, you can specify the system-defined axis variable name for AT specification of a user-defined variable. This will allow you to specify the user-defined variable.

If you use Sysmac Studio version 1.28 or lower, do not specify any user-defined variable created in the variable table.

## Function

- The MC\_Stop instruction decelerates an axis from the current velocity to a velocity of 0.

- The deceleration stop operation starts when *Execute* changes to TRUE.
- *CommandAborted* for the instruction that is currently in operation will change to TRUE when MC\_Stop is executed.



### Precautions for Correct Use

You cannot execute this instruction if the *Status.ErrorStop* (Error Deceleration Stopping) variable that gives the status of this axis is TRUE.

Use the MC\_ImmediateStop instruction to stop the motion of an axis that is decelerating to a stop for an error.

## Instruction Details

This section describes the instruction in detail.

### ● Specifying *Deceleration* and *Jerk*

Set the input variables *Deceleration* and *Jerk* to set the deceleration rate and jerk when decelerating to a stop.

The relationship between the deceleration and velocity when *Jerk* is set to 0 and when it is set to any other value is shown below.

#### **Jerk Set to 0**

The command value for the velocity is created with deceleration rate Dt.

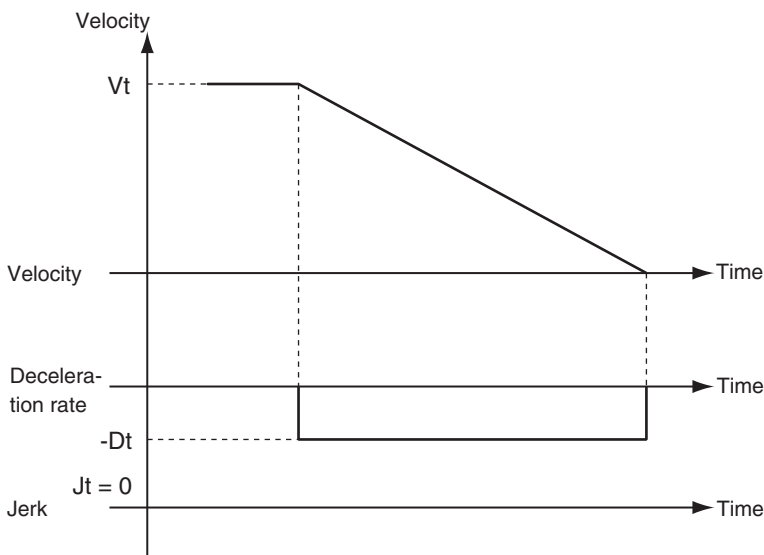

$V_t$ : Velocity when deceleration starts,  $Dt$ : Specified deceleration rate,  $J_t$ : Specified jerk

#### **Jerk Set to Any Value Other Than 0**

The command value for the velocity is created based on the current velocity with  $Dt$  as the upper limit to the deceleration rate.

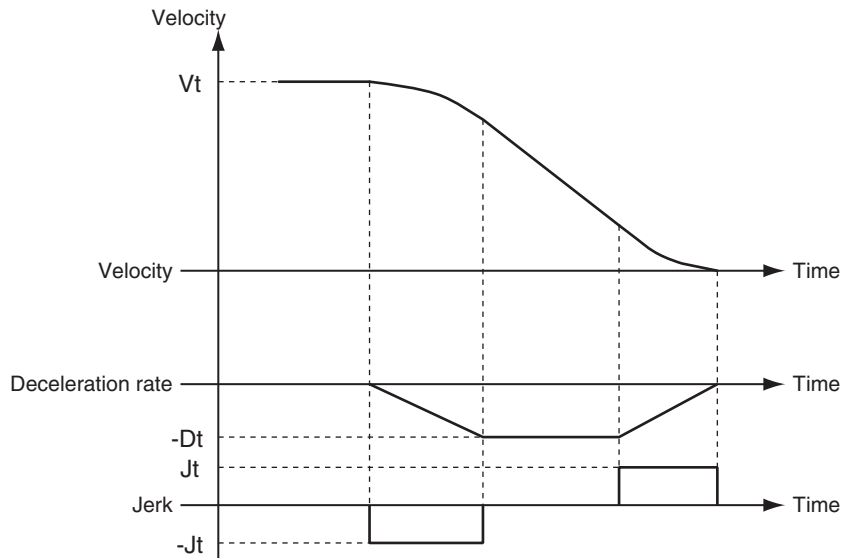

$V_t$ : Velocity when deceleration starts,  $Dt$ : Specified deceleration rate,  $J_t$ : Specified jerk



#### Additional Information

If you set the *Deceleration* to 0, an Immediate Stop instruction is executed. This will stop the axis immediately without decelerating.

An immediate stop occurs regardless of the setting of the **Acceleration/Deceleration Over** axis parameter only when the *Deceleration* is set to 0.

### ● Specifying *BufferMode* (Buffer Mode Selection)

This variable specifies how to join the axis motions for this instruction and the previous instruction. *BufferMode* (Buffer Mode Selection) of this instruction is a reserved parameter for future expansion. There is only the following setting.

Buffer Mode Selection	Description
Aborting	Aborts the instruction being executed and executes this instruction.

For details on *BufferMode* (Buffer Mode Selection), refer to the *NJ/NX-series CPU Unit Motion Control User's Manual (Cat. No. W507)*.

### ● In-position Check

An in-position check is not performed when stopping for this instruction.

## Timing Charts

- *Busy* (Executing) changes to TRUE at the same time as *Execute* changes to TRUE. *Active* (Controlling) changes to TRUE in the next period.
- *Done* changes to TRUE when a velocity of 0 is reached.
- If another instruction aborts this instruction, *CommandAborted* changes to TRUE and *Busy* (Executing) and *Active* (Controlling) change to FALSE.

## Executing an Axis Instruction

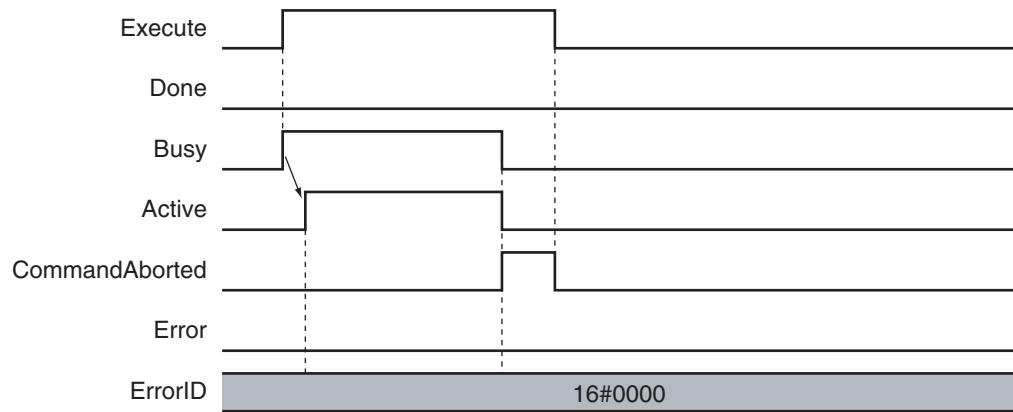

## Executing MC\_Stop Instruction

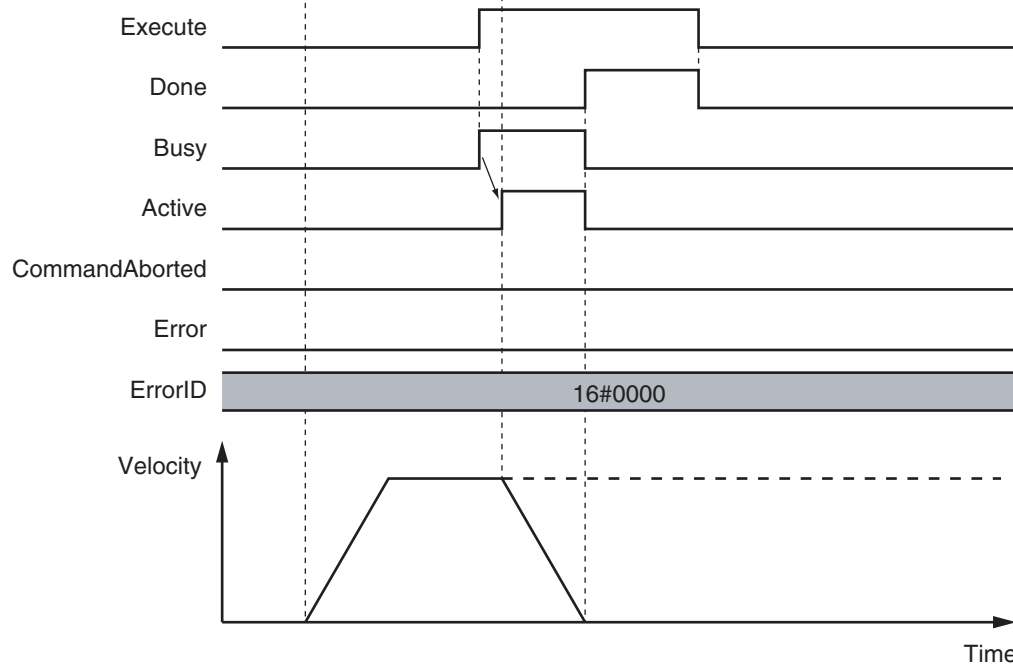

## Re-execution of Motion Control Instructions

*Deceleration* (Deceleration Rate) changes if *Execute* is changed to TRUE again while this instruction is in execution.

The *Jerk* setting is not changed when a motion control instruction is re-executed.

### ● Jerk Set to Any Value Other Than 0

The command value for the velocity is created based on the current velocity and deceleration rate, with  $Dt2$  as the upper limit to the deceleration rate after it is changed.

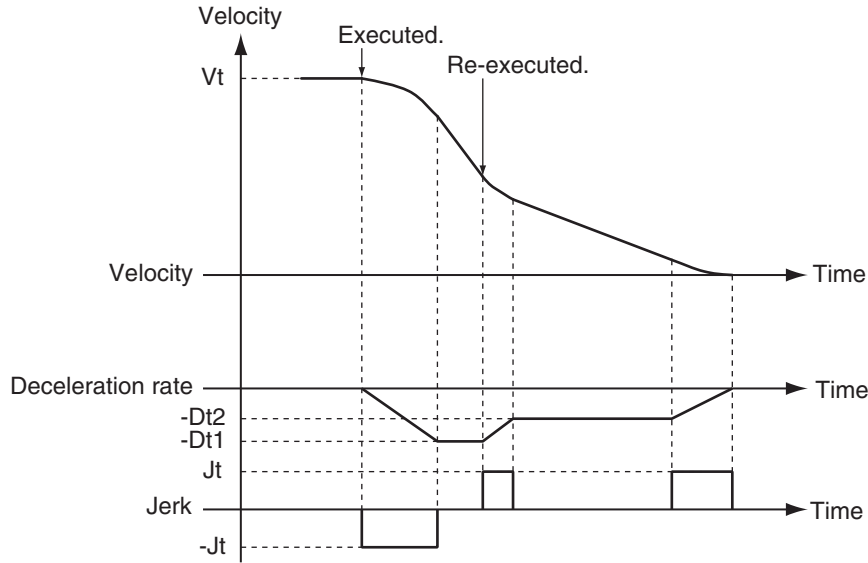

$V_t$ : Velocity when deceleration starts,  $Dt$ : Specified deceleration rate,  $J_t$ : Specified jerk

## Multi-execution of Motion Control Instructions

For details on multi-execution of motion control instructions, refer to the *NJ/NX-series CPU Unit Motion Control User's Manual (Cat. No. W507)*.

### ● Execution during Execution of Other Instructions

#### Axes Group Moving

If the MC\_Stop instruction is executed for an axis that is in an axes group motion, an error will occur for the axis.

An error will occur also for the axes group, and the axes group motion will stop.

#### When the *Status.ErrorStop* (Error Deceleration Stopping) Axis Variable Is TRUE

*Status.ErrorStop* (Error Deceleration Stopping) in the Axis Variable is TRUE while there is an error for the axis.

If the MC\_Stop instruction is not executed normally for an axis that is decelerating to a stop for an error, *CommandAborted* changes to TRUE. Use the MC\_ImmediateStop instruction to stop the motion of an axis for which an error occurred.

#### During Execution of the MC\_ResetFollowingError (Reset Following Error Counter) Instruction

If the MC\_Stop instruction is executed during the MC\_ResetFollowingError (Reset Following Error Counter) instruction, *CommandAborted* from the MC\_ResetFollowingError instruction changes to TRUE. The MC\_Stop instruction is executed. However, *Deceleration* (Deceleration Rate) to the MC\_Stop instruction is not used and an immediate stop is performed.

### ● Execution of Other Instructions during Instruction Execution

- If any of the following is executed while the axis is not decelerating to a stop for an MC\_Stop instruction, *Status.Stopping* in the Axis Variable changes to TRUE.
  - MC\_ResetFollowingError (Reset Following Error Counter) instruction
  - An immediate stop for the MC\_TouchProbe (Enable External Latch) instruction
  - When *Execute* is TRUE for any other MC\_Stop instruction.



- Operation is as follows for an axis for which *Status.Stopping* (Deceleration Stopping) is TRUE.
  - a) If single-axis positioning, continuous positioning, synchronized operation, or manual operation is performed, *CommandAborted* from the instruction changes to TRUE.
  - b) If the MC\_ResetFollowingError (Reset Following Error Counter) instruction is executed during MC\_Stop instruction execution, *Done* from the MC\_Stop instruction changes to TRUE and the MC\_ResetFollowingError instruction is executed.
  - c) Multi-execution of more than one MC\_Stop Instruction is possible. *Done* from the first MC\_Stop instruction changes to TRUE.
- *Done* of the MC\_Stop instruction changes to TRUE when one of the following conditions is met after the MC\_Stop instruction is executed.
  - a) When the *Enable* input variable for the MC\_Power instruction changes to FALSE (when the Servo is turned OFF)
  - b) When **1: \_mcImmediateStop** is selected for the *StopMode* input variable to the MC\_TouchProbe (Enable External Latch) instruction, the trigger condition is met, and the OMRON 1S-series Servo Drive or G5-series Servo Drive stops immediately

## Errors

Operation will stop if an error (e.g., axis error) occurs during instruction execution.

Specify the stopping method in the axis parameters. The stopping method can be immediate stop, deceleration stop, or Servo OFF.

If you specify a deceleration stop, the axis will continue decelerating until it stops.

For details on setting the Stop Mode in the axis parameters, refer to the *NJ/NX-series CPU Unit Motion Control User's Manual (Cat. No. W507)*.

### ● Timing Chart When Error Occurs

If an error occurs during instruction execution, *Error* will change to TRUE.

You can find out the cause of the error by referring to the value output by *ErrorID* (Error Code).

**MC\_MoveVelocity**

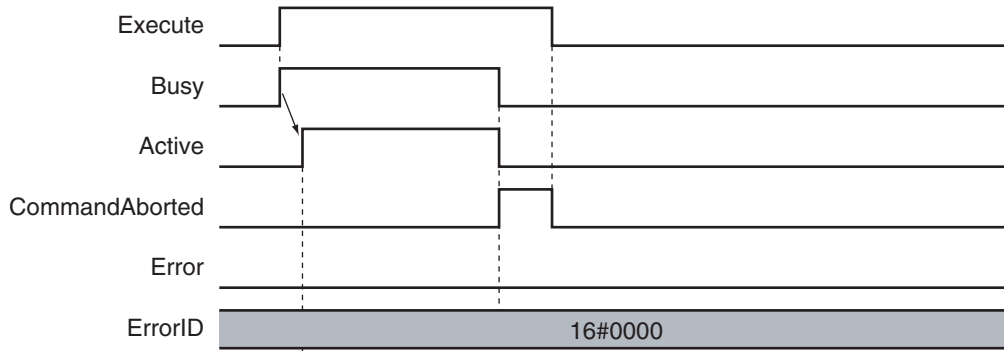

**MC\_Stop**

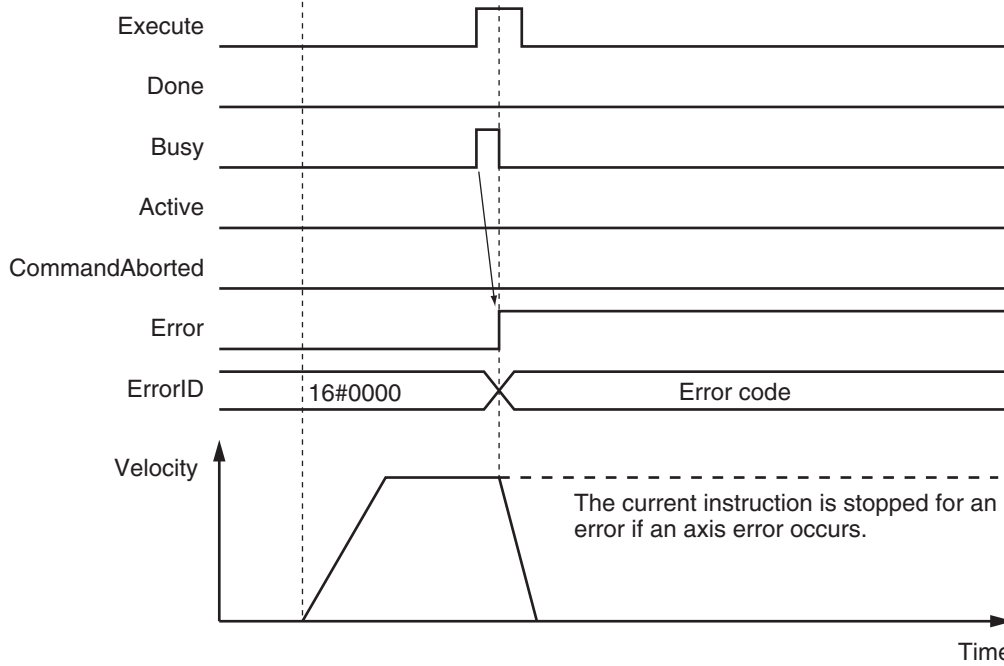

**Version Information**

Operation when an error is reset depends on the unit version of the CPU Unit as follows:  
 Note that you must reset errors only after the axis has stopped. Do not reset errors during axis motion.

• **A CPU Unit with unit version 1.10 or later:**

If you clear the error for this instruction, the instruction will not start until *Execute* changes to TRUE again.

**Ver. 1.10 or Later**

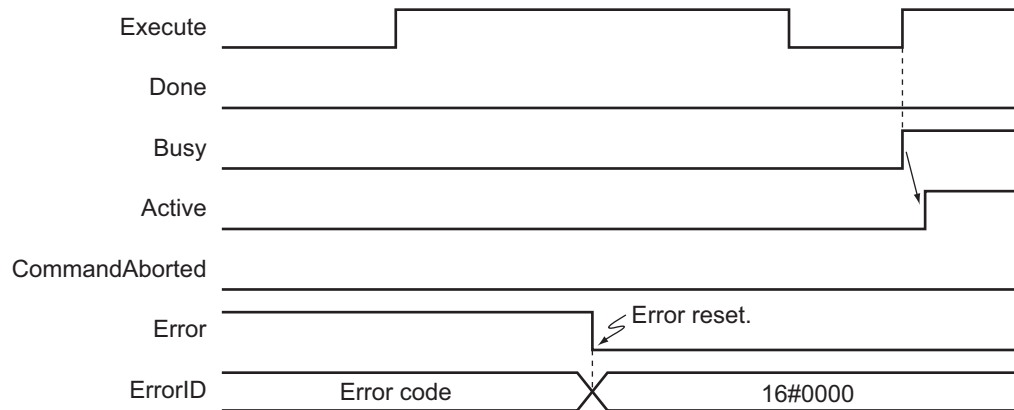

• **A CPU Unit with unit version 1.09 or earlier:**

If an error occurs for this instruction and the error is reset while *Execute* is TRUE, operation will be performed as follows.

- a) If the cause of the error has already been removed, *Error* changes to FALSE and *Done* changes to TRUE. *Status.Stopping* (Deceleration Stopping) in the Axis Variable changes to TRUE in the same way as for normal execution of the deceleration stop.
- b) If the cause of the error has not been removed, *Error* changes to TRUE again for this instruction and an axis error occurs.

In the following timing chart, the cause of the error is removed.

**Ver. 1.09 or Earlier**

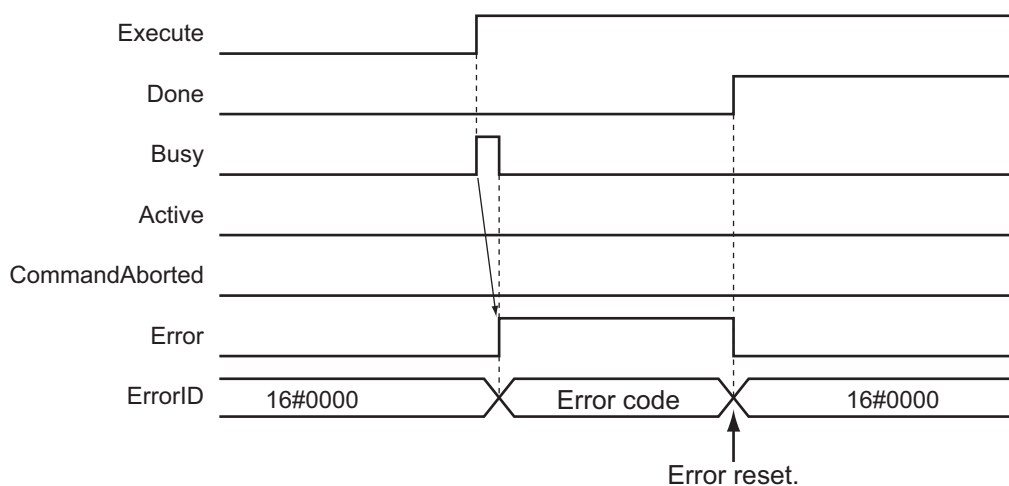

● **Error Codes**

Refer to the *NJ/NX-series Troubleshooting Manual (Cat. No. W503)* for instruction errors.

# MC\_ImmediateStop

The MC\_ImmediateStop instruction stops an axis according to the stopping mode that is set with the *StopMode* (Stopping Mode Selection) input variable regardless of the status of the axis.

Instruction	Name	FB/ FUN	Graphic expression	ST expression
MC_Immediate- Stop	Immediate Stop	FB		<pre>MC_ImmediateStop_instance (   Axis :=parameter,   Execute :=parameter,   StopMode :=parameter,   Done =&gt;parameter,   Busy =&gt;parameter,   CommandAborted =&gt;parameter,   Error =&gt;parameter,   ErrorID =&gt;parameter );</pre>

## Variables

### Input Variables

Name	Meaning	Data type	Valid range	De- fault	Description
Execute	Execute	BOOL	TRUE or FALSE	FALS E	The instruction is executed when the value of this variable changes to TRUE.
StopMode	Stopping Mode Selec- tion	_eMC_STOP _MODE	1: _mcImmediateStop 2: _mcImmediateStopFEReset 3: _mcFreeRunStop	1 *1	Select the stopping mode. 1: Perform an immediate stop. 2: Perform an immediate stop and reset the following error counter. 3: Perform an immediate stop and turn OFF the Servo.

\*1. The default value for an enumeration variable is actually not the number, but the enumerator.

### Output Variables

Name	Meaning	Data type	Valid range	Description
Done	Done	BOOL	TRUE or FALSE	TRUE when the instruction is completed.
Busy	Executing	BOOL	TRUE or FALSE	TRUE when the instruction is acknowledged.
CommandAborted	Command Aborted	BOOL	TRUE or FALSE	TRUE when the instruction is aborted.
Error	Error	BOOL	TRUE or FALSE	TRUE while there is an error.

Name	Meaning	Data type	Valid range	Description
ErrorID	Error Code	WORD	*1	Contains the error code when an error occurs. A value of 16#0000 indicates normal execution.

\*1. The upper four digits of the event code give the error code for ErrorID. Refer to the *NJ/NX-series Troubleshooting Manual (Cat. No. W503)* for the event codes.

### ● Output Variable Update Timing

Name	Timing for changing to TRUE	Timing for changing to FALSE
Done	When the axis has decelerated to a stop.	<ul style="list-style-type: none"> <li>When <i>Execute</i> is TRUE and changes to FALSE.</li> <li>After one period when <i>Execute</i> is FALSE.</li> </ul>
Busy	When <i>Execute</i> changes to TRUE.	<ul style="list-style-type: none"> <li>When <i>Done</i> changes to TRUE.</li> <li>When <i>Error</i> changes to TRUE.</li> <li>When <i>CommandAborted</i> changes to TRUE.</li> </ul>
CommandAborted	<ul style="list-style-type: none"> <li>When this instruction is canceled because another MC_Stop instruction was executed with the Buffer Mode set to <b>Aborting</b>.</li> <li>When this instruction is canceled due to an error.</li> </ul>	<ul style="list-style-type: none"> <li>When <i>Execute</i> is TRUE and changes to FALSE.</li> <li>After one period when <i>Execute</i> is FALSE.</li> </ul>
Error	When there is an error in the execution conditions or input parameters for the instruction.	When the error is cleared.

## In-Out Variables

Name	Meaning	Data type	Valid range	Description
Axis	Axis	_sAXIS_REF	---	Specifies the axis. *1

\*1. Specify a user-defined Axis Variable that was created in the Axis Basic Settings of the Sysmac Studio (default: MC\_Axis\*) or a system-defined axis variable name (\_MC\_AX[\*], \_MC1\_AX[\*], or \_MC2\_AX[\*]).

If you use Sysmac Studio version 1.29 or higher, you can specify the system-defined axis variable name for AT specification of a user-defined variable. This will allow you to specify the user-defined variable.

If you use Sysmac Studio version 1.28 or lower, do not specify any user-defined variable created in the variable table.

## Function

- You can execute the MC\_ImmediateStop instruction under any conditions.  
For example, you can use this instruction to stop an axis immediately even if it is decelerating to a stop for an error.  
You cannot execute the MC\_Stop instruction while *Status.ErrorStop* (Error Deceleration Stopping) is TRUE, but you can execute the MC\_ImmediateStop instruction.
- When this instruction is executed, the axis stops immediately according to *StopMode* (Stopping Mode Selection). *CommandAborted* changes to TRUE for the instruction that is currently in operation.
- Status.ErrorStop* (Error Deceleration Stopping) in the axis status changes to TRUE when this instruction is executed and an Immediate Stop Instruction Executed error (error code: 5485 hex) occurs.



### Precautions for Correct Use

Refer to 1-1-3 *Precautions for Master and Auxiliary Axes in Synchronized Control* on page 1-6 for precautions on the master axis.

## Timing Charts

- *Busy* (Executing) changes to TRUE when *Execute* changes to TRUE.
- *Done* changes to TRUE when processing of the Immediate Stop instruction is completed.

### MC\_Move Instruction

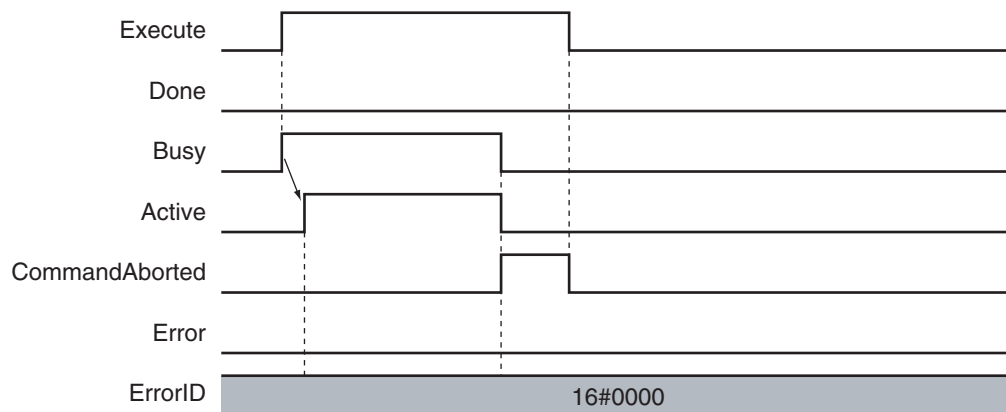

### MC\_ImmediateStop Instruction

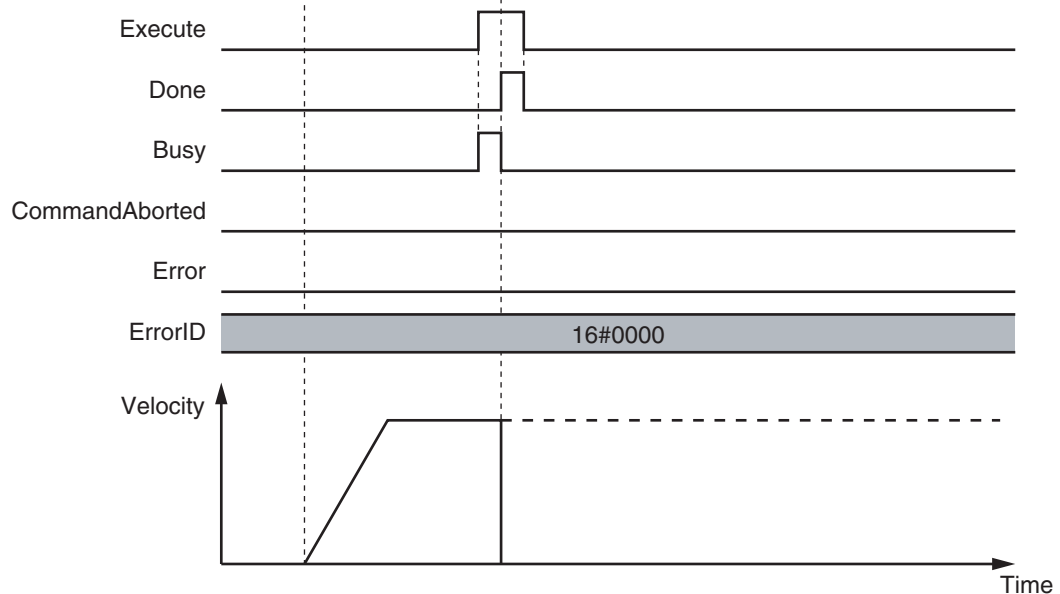

## Re-execution of Motion Control Instructions

This instruction cannot be re-executed.

A Motion Control Instruction Re-execution Disabled error (error code: 543B hex) occurs if re-execution is attempted.

## Multi-execution of Motion Control Instructions

For details on multi-execution of motion control instructions, refer to the *NJ/NX-series CPU Unit Motion Control User's Manual (Cat. No. W507)*.

### ● Execution during Execution of Other Instructions

#### Axes Group Moving

If the instruction is executed for an axis that is in an axes group motion, an error will occur for the axis and an immediate stop is performed.

An error will also occur for the axis group, and the axis group motion will stop.

#### When the *Status.Stopping* (Deceleration Stopping) Axis Variable Is TRUE

*Status.Stopping* (Deceleration Stopping) in the Axis Variable changes to TRUE in the following cases.

- While the axis is decelerating for the MC\_Stop instruction
- During execution of the MC\_ResetFollowingError (Reset Following Error Counter) instruction
- During an immediate stop for the MC\_TouchProbe (Enable External Latch) instruction
- While *Execute* is TRUE for one or more MC\_Stop instructions

You can execute this instruction for an axis for which *Status.Stopping* (Deceleration Stopping) is TRUE.

When this instruction is executed, *CommandAborted* from the following instructions changes to TRUE.

- MC\_Stop instruction
- MC\_ResetFollowingError (Reset Following Error Counter) instruction
- MC\_TouchProbe (Enable External Latch) instruction (during the immediate stop)

#### When the *Status.ErrorStop* (Error Deceleration Stopping) Axis Variable Is TRUE

*Status.ErrorStop* (Error Deceleration Stopping) in the axis status is TRUE while there is an error for the axis.

You can execute this instruction even for an axis that is decelerating to a stop for an error.

## Error

The axis will stop immediately even if an error (e.g., axis error) occurs during instruction execution.

For details on setting the Stop Mode in the axis parameters, refer to the *NJ/NX-series CPU Unit Motion Control User's Manual (Cat. No. W507)*.

### ● Timing Chart When Error Occurs

If an error occurs during instruction execution, *Error* will change to TRUE.

You can find out the cause of the error by referring to the value output by *ErrorID* (Error Code).

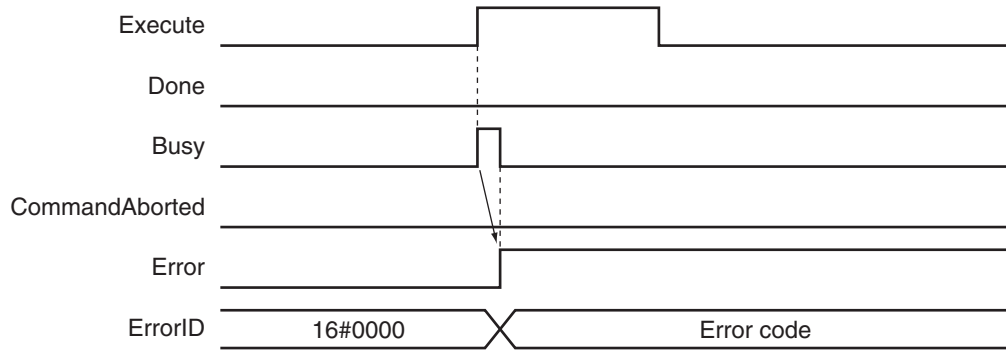

## ● Error Codes

Refer to the *NJ/NX-series Troubleshooting Manual (Cat. No. W503)* for instruction errors.



# MC\_SetPosition

The MC\_SetPosition instruction changes the command current position or the actual current position of an axis as required.

Instruction	Name	FB/ FUN	Graphic expression	ST expression
MC_SetPosition	Set Position	FB		<pre>MC_SetPosition_instance (   Axis :=parameter,   Execute :=parameter,   Position :=parameter,   ReferenceType :=parameter,   Relative :=parameter,   ExcutionMode :=parameter,   Done =&gt;parameter,   Busy =&gt;parameter,   CommandAborted =&gt;parameter,   Error =&gt;parameter,   ErrorID =&gt;parameter );</pre>

## Variables

### Input Variables

Name	Meaning	Data type	Valid range	De- fault	Description
Execute	Execute	BOOL	TRUE or FALSE	FALS E	The instruction is executed when the value of this variable changes to TRUE.
Position	Target Position	LREAL	Negative number, positive number, or 0	0	Specify the absolute target position. The unit is command units. *1
ReferenceType	Position Type Selection	_eMC_REFERENCE_TYPE	0: _mcCommand 1: _mcFeedback	0 *2	Specifies the position type. 0: Command position (servo axis or virtual servo axis) 1: Actual position (encoder axis or virtual encoder axis)
Relative (Reserved)	Relative Position Selection	BOOL	TRUE or FALSE	FALS E	(Reserved)
Execution-Mode (Reserved)	Execution Mode	_eMC_EXECUTION_MODE	0: _mclmmediately	0 *2	(Reserved)

\*1. Refer to *Unit Conversion Settings* in the *NJ/NX-series CPU Unit Motion Control User's Manual (Cat. No. W507)* for information on command units.

\*2. The default value for an enumeration variable is actually not the number, but the enumerator.

## Output Variables

Name	Meaning	Data type	Valid range	Description
Done	Done	BOOL	TRUE or FALSE	TRUE when the instruction is completed.
Busy	Executing	BOOL	TRUE or FALSE	TRUE when the instruction is acknowledged.
CommandAborted	Command Aborted	BOOL	TRUE or FALSE	TRUE when the instruction is aborted.
Error	Error	BOOL	TRUE or FALSE	TRUE while there is an error.
ErrorID	Error Code	WORD	*1	Contains the error code when an error occurs. A value of 16#0000 indicates normal execution.

\*1. The upper four digits of the event code give the error code for ErrorID. Refer to the *NJ/NX-series Troubleshooting Manual (Cat. No. W503)* for the event codes.

### ● Output Variable Update Timing

Name	Timing for changing to TRUE	Timing for changing to FALSE
Done	When changing the command current position and the actual current position are completed.	<ul style="list-style-type: none"> <li>When <i>Execute</i> is TRUE and changes to FALSE.</li> <li>After one period when <i>Execute</i> is FALSE.</li> </ul>
Busy	When <i>Execute</i> changes to TRUE.	<ul style="list-style-type: none"> <li>When <i>Done</i> changes to TRUE.</li> <li>When <i>Error</i> changes to TRUE.</li> </ul>
CommandAborted	<ul style="list-style-type: none"> <li>When this instruction is canceled due to an error.</li> <li>When this instruction is executed while there is an error.</li> <li>When you start this instruction during MC_Stop instruction execution.</li> </ul>	<ul style="list-style-type: none"> <li>When <i>Execute</i> is TRUE and changes to FALSE.</li> <li>After one period when <i>Execute</i> is FALSE.</li> </ul>
Error	When there is an error in the execution conditions or input parameters for the instruction.	When the error is cleared.

## In-Out Variables

Name	Meaning	Data type	Valid range	Description
Axis	Axis	_sAXIS_REF	---	Specifies the axis. *1

\*1. Specify a user-defined Axis Variable that was created in the Axis Basic Settings of the Sysmac Studio (default: MC\_Axis\*) or a system-defined axis variable name (\_MC\_AX[\*], \_MC1\_AX[\*], or \_MC2\_AX[\*]).  
If you use Sysmac Studio version 1.29 or higher, you can specify the system-defined axis variable name for AT specification of a user-defined variable. This will allow you to specify the user-defined variable.  
If you use Sysmac Studio version 1.28 or lower, do not specify any user-defined variable created in the variable table.

## Function

- This instruction changes the command current position of the Servo axis to the specified target position.

If you execute this instruction on an encoder axis, the actual current position will change to the specified target position.

- Specify the target position in absolute coordinates.
- The actual current position changes at the same time as the command current position changes. The following error is kept the same before and after the change. If you execute this instruction on a command servo axis, the difference between the actual position and the actual current position will remain the same before and after the change.

Because of this, after you execute this instruction, the actual current position of the axis takes the value calculated by the following equation.

$$\text{Actual current position after change} = \text{Target position} - \text{Following error before change}$$

- If you specify the actual position for a servo axis or the command position for an encoder axis, a position type error will occur.
- When the Count Mode is set to **Rotary Mode**, set the target position to a value that is equal to or greater than the **Modulo minimum position** and less than the **Modulo maximum position**. A ring counter error will occur if the target position is outside this range.
- When the Count Mode is set to **Linear Mode**, you can set the target position to a value outside the range defined by the software limits.
- You can use this instruction for an axis that is stopped or in motion.



#### Precautions for Correct Use

Home is undefined for the specified axis after this instruction ends.

Because of this, you cannot execute following functions or instructions after this instruction ends.

- Software limits
- MC\_MoveZeroPosition (High-speed Home) instruction
- Multi-axes coordinated control instructions (linear or circular interpolation)

### ● ReferenceType (Position Type Selection)

- Set this variable to **0: \_mcCommand** (Command position) to use a servo axis or virtual servo axis.
- Set this variable to **1: \_mcFeedback** (Actual position) to use an encoder axis or virtual encoder axis.

### ● Relationship between Axis Types and Position Types

The relationship between the axis types that you can monitor and position types that is monitored is shown below.

Axis Type	ReferenceType	
	_mcCommand	_mcFeedback
Servo axis	OK	No
Encoder axis	No *1	OK
Virtual servo axis	OK	No
Virtual encoder axis	No *1	OK

\*1. A Position Type Selection Out of Range error (error code: 5430 hex) occurs when the instruction is executed.

## Timing Charts

### ● Execution While Axis Is Stopped

The actual position starts changing when *Execute* changes to TRUE.

*Busy* (Executing) changes to TRUE when *Execute* changes to TRUE. *Done* changes to TRUE after the actual position is changed.

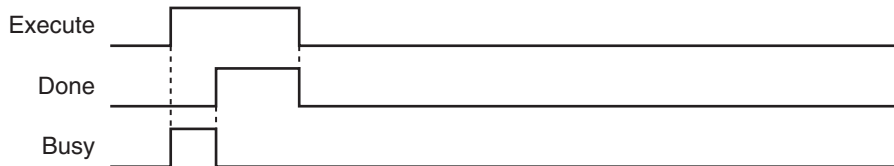

### ● Execution While Axis Is in Motion

If you execute this instruction while positioning to an absolute position, the target value will change according to the change in position.

As an example, the axis operation and timing chart are shown below for a situation where the actual position is changed from 200 mm to 800 mm while the axis is moved to 400 mm for an MC\_MoveAbsolute (Absolute Positioning) instruction.

The axis will move in the negative direction because the actual value is 800 mm and the target value is 400 mm.

As shown in the following figure, even if the actual position is changed, the MC\_MoveAbsolute (Absolute Positioning) instruction will move the axis from the new actual position to the specified target position. When the specified target position is reached, *Done* changes to TRUE.

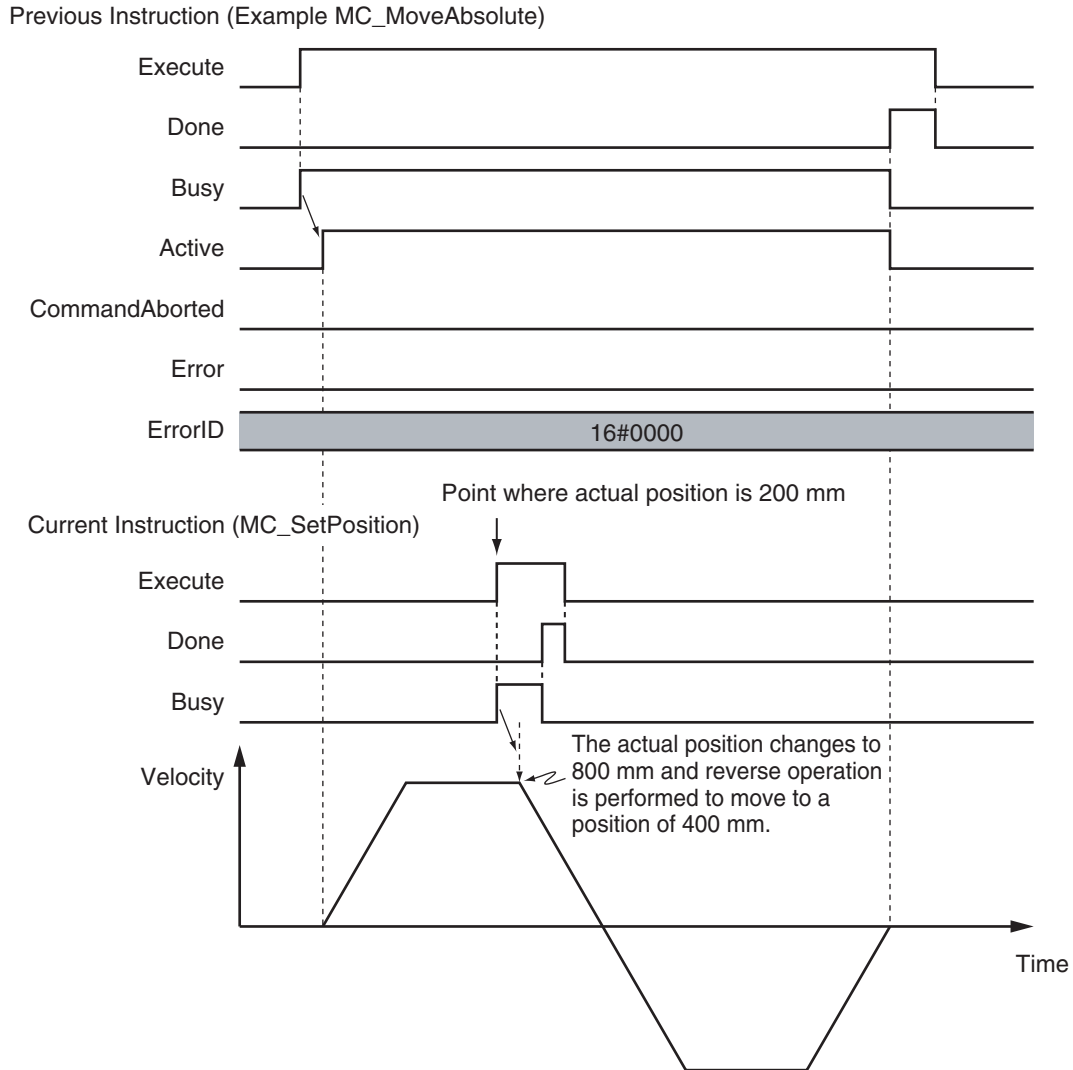

#### Additional Information

- If you execute this instruction while the MC\_MoveRelative (Relative Positioning) or MC\_MoveVelocity (Velocity Control) instruction is in execution, the actual position will change. However, if you execute this instruction while the MC\_MoveRelative (Relative Positioning) or MC\_MoveVelocity (Velocity Control) instruction is in execution, the operation of these instructions will not be affected.
- If there is a buffered instruction, positioning is performed for the position after the change when the buffer is switched.

## Re-execution of Motion Control Instructions

This instruction cannot be re-executed.

A Motion Control Instruction Re-execution Disabled error (error code: 543B hex) occurs if re-execution is attempted.

## Multi-execution of Motion Control Instructions

For details on multi-execution of motion control instructions, refer to the *NJ/NX-series CPU Unit Motion Control User's Manual (Cat. No. W507)*.

### ● Execution during Execution of Other Instructions

You cannot use the MC\_SetPosition instruction on an axis for which any of the following instructions is being executed.

A multi-execution of instructions error will occur if it is executed.

MC_MoveJog (Jog) instruction	MC_MoveLink (Synchronous Positioning) instruction
MC_Home (Home) instruction	MC_CombineAxes (Combine Axes) instruction
MC_HomeWithParameter (Home with Parameters) instruction	MC_MoveZeroPosition (High-speed Home) instruction
MC_CamIn (Start Cam Operation) Instruction	MC_TorqueControl (Torque Control) Instruction
MC_GearIn (Start Gear Operation) Instruction	MC_SyncMoveVelocity (Cyclic Synchronous Velocity Control) instruction
MC_GearInPos (Positioning Gear Operation) instruction	



### Precautions for Correct Use

#### CPU Units with Unit Version 1.09 or Earlier

Do not use the MC\_SetPosition instruction for *Master* (Master Axis) that is in synchronized operation for instructions such as MC\_GearIn (Start Gear Operation).

If it is used for a *Master* (Master Axis), as soon as the command current position and the actual current position of the *Master* (Master Axis) are changed, the *Slave* (Slave Axis) will detect that the *Master* (Master Axis) has moved. It will then begin moving corresponding to the *Master* (Master Axis) travel distance. For this reason, the *Slave* (Slave Axis) may change suddenly or the cam motion may end suddenly.

If you want to use the MC\_SetPosition instruction for the *Master* (Master Axis), disable the relationship between the *Master* (Master Axis) and *Slave* (Slave Axis) before executing the instruction.

Execute an instruction such as the MC\_GearOut (End Gear Operation) instruction to disable the relationship between the *Master* (Master Axis) and *Slave* (Slave Axis).

Refer to 1-1-3 *Precautions for Master and Auxiliary Axes in Synchronized Control* on page 1-6 for precautions on the master axis.

### ● Execution of Other Instructions during Instruction Execution

If another MC\_SetPosition instruction is executed while there is one already in execution, the last instruction takes priority.

In this case, *Done* for the first MC\_SetPosition instruction will change to TRUE, but the change to the set position for the first instruction is not completed.

## Errors

If an error occurs during instruction execution, *Error* will change to TRUE.

You can find out the cause of the error by referring to the value output by *ErrorID* (Error Code).



### Additional Information

If you execute this instruction while the axis is in motion, the instruction of the axis currently in motion will be restarted and the data required for positioning will be recalculated.  
If an error occurs, it will be for the instruction of the axis currently in motion rather than for this instruction.

### ● Timing Chart When Error Occurs

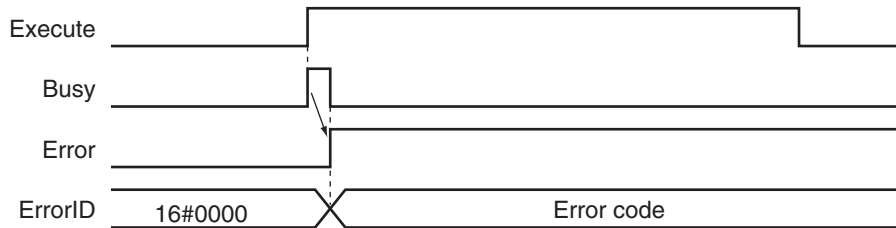

### ● Error Codes

Refer to the *NJ/NX-series Troubleshooting Manual (Cat. No. W503)* for instruction errors.

# MC\_SetOverride

The MC\_SetOverride instruction changes the target velocity for an axis.

Instruction	Name	FB/ FUN	Graphic expression	ST expression
MC_SetOverride	Set Override Factors	FB		<pre>MC_SetOverride_instance (   Axis :=parameter,   Enable :=parameter,   VelFactor :=parameter,   AccFactor :=parameter,   JerkFactor :=parameter,   Enabled =&gt;parameter,   Busy =&gt;parameter,   Error =&gt;parameter,   ErrorID =&gt;parameter );</pre>

## Variables

### Input Variables

Name	Meaning	Data type	Valid range	De- fault	Description
Enable	Enable	BOOL	TRUE or FALSE	FALSE	The override factors are enabled when the value of this variable is TRUE. The override factors return to 100% when the value of this variable changes to FALSE.
VelFactor	Velocity Override Factor	LREAL	0 to 500	100	Specify the velocity override factor. The valid range of the override factors is between 0.01 and 500.00. Values above 500.00 are treated as 500 and values less than 0.01 (including negative values) are treated as 0.01. The override factor will be 0 only when 0 is specified. The unit is %.
AccFactor (Reserved)	Acceleration/ Deceleration Override Factor	LREAL	0 to 500	100	(Reserved)
JerkFactor (Reserved)	Jerk Override Factor	LREAL	0 to 500	100	(Reserved)

### Output Variables

Name	Meaning	Data type	Valid range	Description
Enabled	Enabled	BOOL	TRUE or FALSE	TRUE when the axis is being controlled.



Name	Meaning	Data type	Valid range	Description
Busy	Executing	BOOL	TRUE or FALSE	TRUE when the instruction is acknowledged.
Error	Error	BOOL	TRUE or FALSE	TRUE while there is an error.
ErrorID	Error Code	WORD	*1	Contains the error code when an error occurs. A value of 16#0000 indicates normal execution.

\*1. The upper four digits of the event code give the error code for ErrorID. Refer to the *NJ/NX-series Troubleshooting Manual (Cat. No. W503)* for the event codes.

### ● Output Variable Update Timing

Name	Timing for changing to TRUE	Timing for changing to FALSE
Enabled	When <i>Enable</i> changes to TRUE.	<ul style="list-style-type: none"> <li>After one period when <i>Enable</i> is FALSE.</li> <li>When <i>Error</i> changes to TRUE.</li> </ul>
Busy	When <i>Enable</i> changes to TRUE.	<ul style="list-style-type: none"> <li>When <i>Enable</i> changes to FALSE.</li> <li>When <i>Error</i> changes to TRUE.</li> </ul>
Error	When there is an error in the execution conditions or input parameters for the instruction.	When the error is cleared.

## In-Out Variables

Name	Meaning	Data type	Valid range	Description
Axis	Axis	_sAXIS_REF	---	Specifies the axis. *1

\*1. Specify a user-defined Axis Variable that was created in the Axis Basic Settings of the Sysmac Studio (default: MC\_Axis\*) or a system-defined axis variable name (\_MC\_AX[\*], \_MC1\_AX[\*], or \_MC2\_AX[\*]).

If you use Sysmac Studio version 1.29 or higher, you can specify the system-defined axis variable name for AT specification of a user-defined variable. This will allow you to specify the user-defined variable.

If you use Sysmac Studio version 1.28 or lower, do not specify any user-defined variable created in the variable table.

## Function

- The MC\_SetOverride instruction changes override factors related to the target velocity of the axis. Changes the target velocity of the axes in operation by changing the override.
- The override factors apply only to the following instructions.

MC_Move (Positioning) instruction	MC_MoveJog (Jog) instruction
MC_MoveAbsolute (Absolute Positioning) instruction	MC_MoveFeed (Interrupt Feeding) instruction
MC_MoveRelative (Relative Positioning) instruction	MC_MoveZeroPosition (High-speed Home) instruction
MC_MoveVelocity (Velocity Control) instruction	

- The new target velocity is found with the following equation.

The target velocity after the change = Target velocity of the current instruction × Override factor

- The unit for override factors is %. A setting of 100 indicates 100%.
- If the target velocity that results from the override exceeds the **Maximum Velocity** set in the axis parameters, the maximum velocity is used.
- The axis will accelerate or decelerate to the target velocity that results from the override.

- If the velocity override factor is set to 0, the target velocity will be 0. Axis operation will decelerate to a velocity of 0, and operation will continue.  
If you want to pause the axis motion while maintaining the operation status, set the override factor to 0.  
*Status.Discrete* and *Status.Continuous* in the Axis Variable do not change at this time.
- The override factors are always updated when the instruction is executed as long as *Enable* remains TRUE.
- The override factors apply to operation commands for new target velocities, e.g., when you start a stopped axis, re-execute a motion instruction, or perform multi-execution of motion control instructions.
- The override factors will return to 100% when *Enable* changes to FALSE.
- If an axis error occurs during MC\_SetOverride instruction execution, the value of *Enabled* for the MC\_SetOverride instruction remains TRUE.



### Precautions for Correct Use

---

When *Enable* to this instruction changes to FALSE, *Enabled* and *Busy* from this instruction change to FALSE.  
The axis will accelerate or decelerate to a velocity with a 100% override factor.

---



### Additional Information

---

#### Influence on Other Instructions

Use this instruction to temporarily change the target velocities of other instructions.  
This instruction has no effect on instructions to which a target velocity is not input or instructions for which the target velocity is updated every period, such the Cyclic Synchronous Velocity Control instruction.  
However, *Enabled* remains TRUE even if the MC\_SetOverride (Set Override Factors) instruction is executed for an instruction to which it does not apply.

---

## Timing Charts

---

### ● Overriding the MC\_MoveAbsolute Instruction

An example of a time chart for using the MC\_SetOverride (Set Override Factors) instruction for the MC\_MoveAbsolute (Absolute Positioning) instruction is given below.

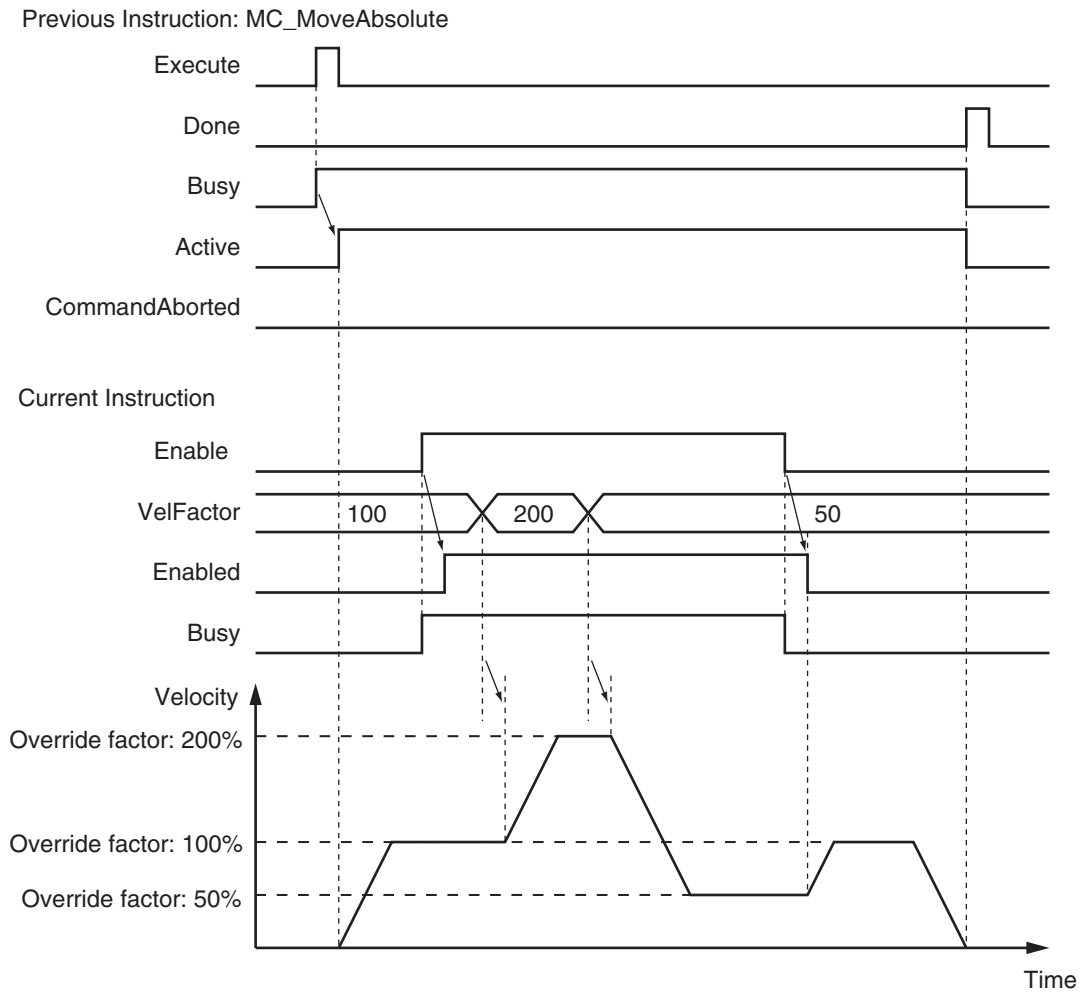

If the MC\_SetOverride instruction is disabled, the target velocity returns to an override factor of 100%.

### ● Overrides for the MC\_MoveVelocity (Velocity Control) Instruction

An example of a time chart for using the MC\_SetOverride (Set Override Factors) instruction for the MC\_MoveVelocity (Velocity Control) instruction is given below.

After *InVelocity* (Target Velocity Reached) changes to TRUE, it will stay TRUE even if the velocity changes.

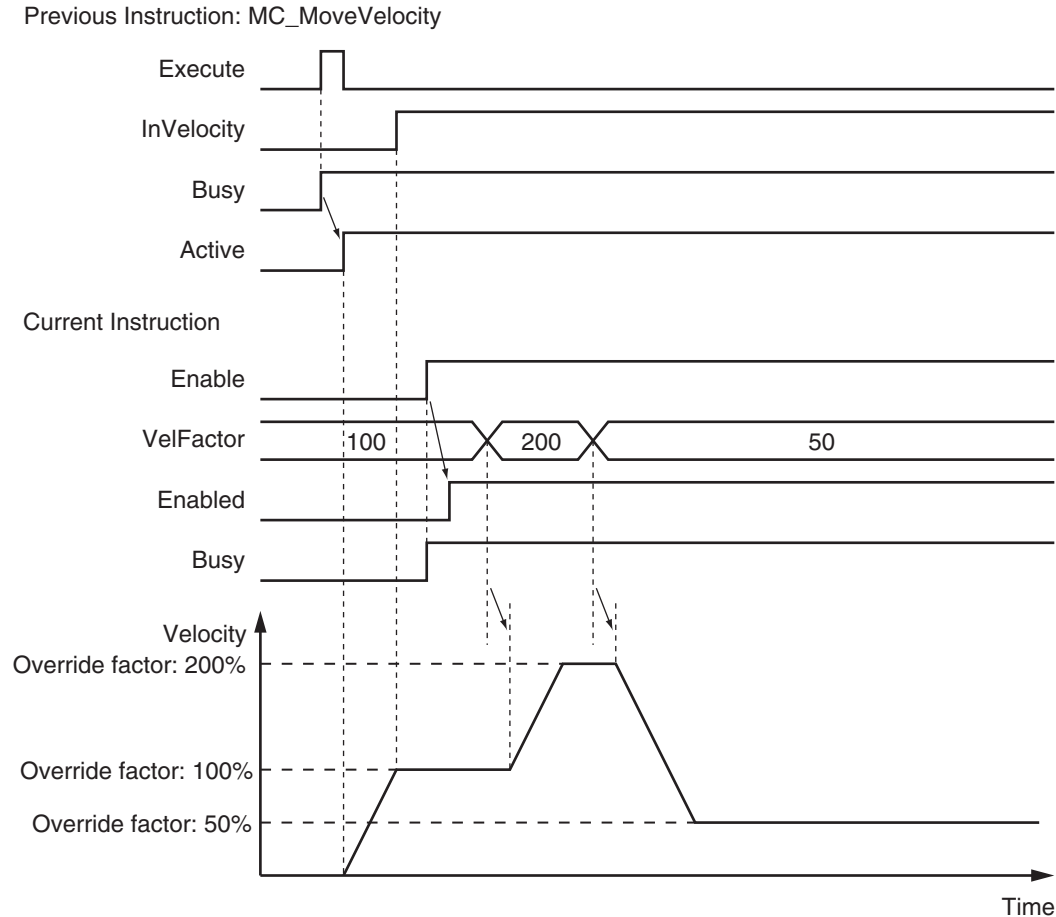

## Re-execution of Motion Control Instructions

You cannot re-execute motion instructions with enable-type inputs.

## Multi-execution of Motion Control Instructions

For details on multi-execution of motion control instructions, refer to the *NJ/NX-series CPU Unit Motion Control User's Manual (Cat. No. W507)*.

### ● Multi-execution of MC\_SetOverride Instructions

If another instance of MC\_SetOverride is executed for the same axis during MC\_SetOverride instruction execution, the last MC\_SetOverride instance that is executed takes priority in processing.

*Enabled* will be TRUE for both instructions.

Concretely, the override values of the instance that was executed last are valid. If *Enable* to the instance that was executed last changes to FALSE, the overrides are disabled.

## Errors

If an error occurs during instruction execution, *Error* will change to TRUE.

You can find out the cause of the error by referring to the value output by *ErrorID* (Error Code).

● **Timing Chart When Error Occurs**

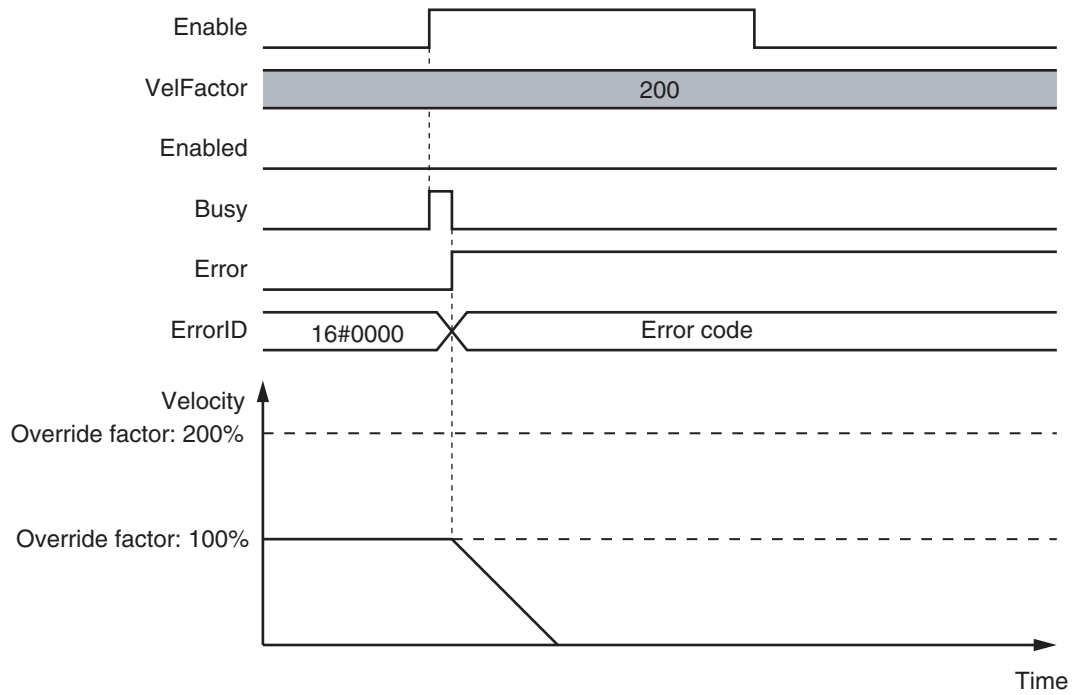

● **Error Codes**

Refer to the *NJ/NX-series Troubleshooting Manual (Cat. No. W503)* for instruction errors.

# MC\_ResetFollowingError

The MC\_ResetFollowingError instruction resets the following error between the command current position and the actual current position.

Instruction	Name	FB/ FUN	Graphic expression	ST expression
MC_ResetFollowingError	Reset Following Error Counter	FB		<pre>MC_ResetFollowingError_in- stance (   Axis :=parameter,   Execute :=parameter,   BufferMode :=parameter,   Done =&gt;parameter,   Busy =&gt;parameter,   Active =&gt;parameter,,   CommandAborted =&gt;parameter,   Error =&gt;parameter,   ErrorID =&gt;parameter );</pre>

## Variables

### Input Variables

Name	Meaning	Data type	Valid range	De- fault	Description
Execute	Execute	BOOL	TRUE or FALSE	FALS E	The instruction is executed when the value of this variable changes to TRUE.
BufferMode	Buffer Mode Se- lection	_eMC_BUF- FER_MODE	0: _mcAborting	0*1	Specify the behavior when execut- ing more than one motion instruc- tion. 0: Aborting

\*1. The default value for an enumeration variable is actually not the number, but the enumerator.

### Output Variables

Name	Meaning	Data type	Valid range	Description
Done	Done	BOOL	TRUE or FALSE	TRUE when the instruction is completed.
Busy	Executing	BOOL	TRUE or FALSE	TRUE when the instruction is acknowledged.
Active	Controlling	BOOL	TRUE or FALSE	TRUE when the axis is being controlled.
CommandAborted	Command Aborted	BOOL	TRUE or FALSE	TRUE when the instruction is aborted.

Name	Meaning	Data type	Valid range	Description
Error	Error	BOOL	TRUE or FALSE	TRUE while there is an error.
ErrorID	Error Code	WORD	*1	Contains the error code when an error occurs. A value of 16#0000 indicates normal execution.

\*1. The upper four digits of the event code give the error code for ErrorID. Refer to the *NJ/NX-series Troubleshooting Manual (Cat. No. W503)* for the event codes.

### ● Output Variable Update Timing

Name	Timing for changing to TRUE	Timing for changing to FALSE
Done	When resetting the following error counter is completed.	<ul style="list-style-type: none"> <li>When <i>Execute</i> is TRUE and changes to FALSE.</li> <li>After one period when <i>Execute</i> is FALSE.</li> </ul>
Busy	When <i>Execute</i> changes to TRUE.	<ul style="list-style-type: none"> <li>When <i>Done</i> changes to TRUE.</li> <li>When <i>Error</i> changes to TRUE.</li> <li>When <i>CommandAborted</i> changes to TRUE.</li> </ul>
Active	When the instruction is started.	<ul style="list-style-type: none"> <li>When <i>Done</i> changes to TRUE.</li> <li>When <i>Error</i> changes to TRUE.</li> <li>When <i>CommandAborted</i> changes to TRUE.</li> </ul>
CommandAborted	<ul style="list-style-type: none"> <li>When the MC_ResetFollowingError instruction is aborted because another motion control instruction was executed with the Buffer Mode set to <b>Aborting</b>.</li> <li>When this instruction is canceled due to an error.</li> <li>When this instruction is executed while there is an error.</li> </ul>	<ul style="list-style-type: none"> <li>When <i>Execute</i> is TRUE and changes to FALSE.</li> <li>After one period when <i>Execute</i> is FALSE.</li> </ul>
Error	When there is an error in the execution conditions or input parameters for the instruction.	When the error is cleared.

## In-Out Variables

Name	Meaning	Data type	Valid range	Description
Axis	Axis	_sAXIS_REF	---	Specifies the axis. *1

\*1. Specify a user-defined Axis Variable that was created in the Axis Basic Settings of the Sysmac Studio (default: MC\_Axis\*) or a system-defined axis variable name (\_MC\_AX[\*], \_MC1\_AX[\*], or \_MC2\_AX[\*]).

If you use Sysmac Studio version 1.29 or higher, you can specify the system-defined axis variable name for AT specification of a user-defined variable. This will allow you to specify the user-defined variable.

If you use Sysmac Studio version 1.28 or lower, do not specify any user-defined variable created in the variable table.

## Function

- The MC\_ResetFollowingError instruction resets the following error between the command current position and the actual current position in the MC Function Module to 0 in Cyclic Synchronous Position (CSP) Control Mode.
- When *Execute* changes to TRUE, the actual current position at that point is used as the command position (i.e., the target position).

For example, when a following error occurs in the holding operation shown below, you can execute this instruction to implement a position command in the reverse direction and therefore set the following error to 0.

*CommandAborted* for the instruction for which the following error occurred changes to TRUE and instruction execution is aborted.

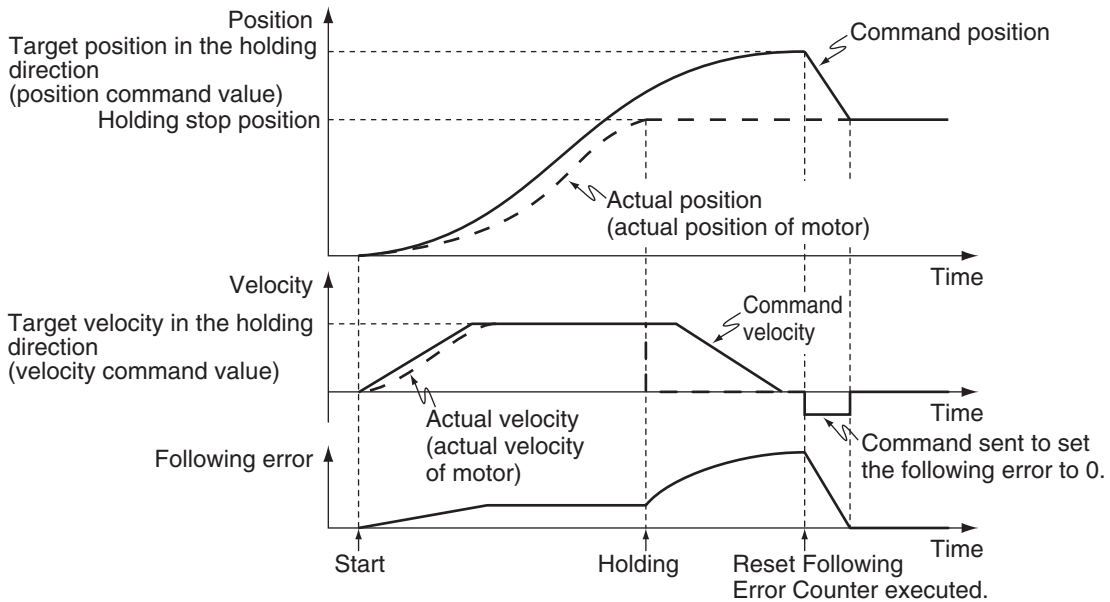

- When the following error is set to 0, the **Maximum Velocity** value that is set in the axis parameters is used to implement a position command. **Maximum Acceleration** and **Maximum Deceleration** are not used.
- When the command to the new target position is completed, the *Done* output variable changed to TRUE.
- This instruction implements a command position in the reverse direction to the direction in which the following error occurred, but the **Operation Selection at Reversing** axis parameter is not used.



#### Precautions for Correct Use

- Execute this instruction only when the axis velocity is low.  
This instruction implements a command value in the opposite direction to the previous instruction (e.g., in the opposite direction to the holding direction). If the axis speed is too high when this instruction is executed, the controlled system may be subjected to shock.
- Before you execute this instruction for a vertical axis, for which constant torque is required, make sure that the torque will not become insufficient.
- If an NX-series Pulse Output Unit is used, the following error in the Servo Drive that is connected to the Pulse Output Unit is not reset. Refer to the *NX-series Position Interface Units User's Manual (Cat. No. W524)* for details.
- **Executing this Instruction for the Master Axis of Synchronized Control**  
If this instruction is executed for the master axis of synchronous control when the command position is used as the synchronization data for the master axis, the slave axis will move in the reverse direction according to the gear ratio or cam data variable.  
Refer to *1-1-3 Precautions for Master and Auxiliary Axes in Synchronized Control* on page 1-6 for precautions on the master axis.



## Instruction Details

This section describes the instruction in detail.

### ● Applicable Axes and Execution Condition

- You can use this instruction for servo and virtual servo axes in the following cases.
  - During single-axis position control
  - During the MC\_MoveVelocity (Velocity Control) instruction
  - During synchronized control
- An error occurs if the instruction is executed for an encoder or virtual encoder axis.

### ● Axis Variable Status

*Status.Stopping* (Deceleration Stopping) in the Axis Variable status changes to TRUE.

### ● Executing this Instruction during Control Mode Changes

If you execute an instruction that changes the control mode to Position Control Mode during execution of the MC\_TorqueControl (Torque Control) or MC\_SyncMoveVelocity (Cyclic Synchronous Velocity Control) instruction and then execute the MC\_ResetFollowingError instruction before the change to Position Control Mode is actually completed, the timing for resetting the following error to 0 depends on the unit version of the CPU Unit as described below.

#### CPU Units with Unit Version 1.10 or Later

- The following error between the command current position and the actual current position is reset to 0 immediately after the change to Position Control Mode is completed.

#### CPU Units with Unit Version 1.09 or Earlier

- The following error between the command current position and the actual current position is reset to 0 as soon as the MC\_ResetFollowingError instruction is executed.

Refer to *MC\_TorqueControl* on page 3-338 and *MC\_SyncMoveVelocity* on page 3-397 for details on changing the control mode.

## Timing Charts

Timing charts for when this instruction is executed during holding status for the MC\_MoveAbsolute (Absolute Positioning) instruction are given below.

MC\_MoveAbsolute instruction

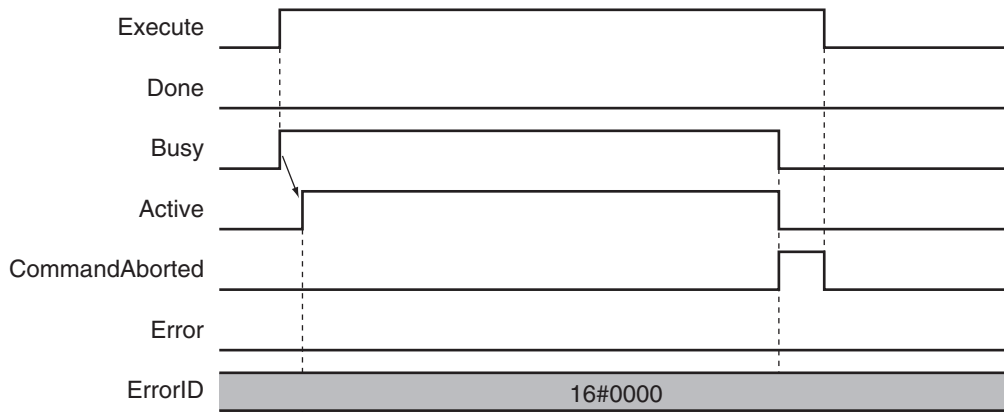

MC\_ResetFollowingError instruction

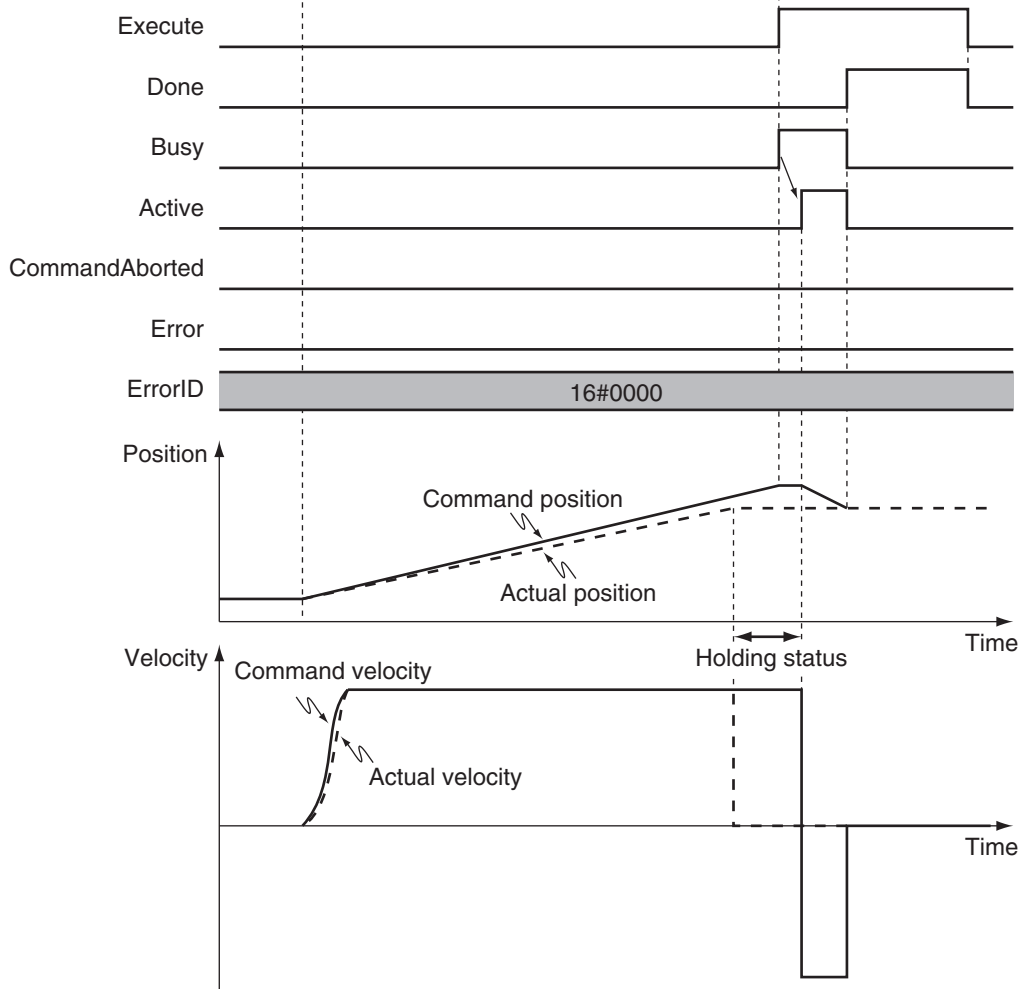

## Re-execution of Motion Control Instructions

This instruction cannot be re-executed.

A Motion Control Instruction Re-execution Disabled error (error code: 543B hex) occurs if re-execution is attempted.

## Multi-execution of Motion Control Instructions

For details on multi-execution of motion control instructions, refer to the *NJ/NX-series CPU Unit Motion Control User's Manual (Cat. No. W507)*.

### ● Execution during Execution of Other Instructions

You can switch to this instruction or buffer this instruction if you execute it during execution of another instruction.

You can buffer one instruction per axis.

Specify the operation of this instruction by using *BufferMode* (Buffer Mode Selection) for multi-execution of instructions.

Buffer Mode Selection	Description
Aborting	Cancels the instruction being executed and switches to this instruction.

For details on *BufferMode* (Buffer Mode Selection), refer to the *NJ/NX-series CPU Unit Motion Control User's Manual (Cat. No. W507)*.

#### Relation to MC\_Stop Instruction

If the MC\_ResetFollowingError (Reset Following Error Counter) instruction is executed during MC\_Stop instruction execution, *Done* from the MC\_Stop instruction changes to TRUE and the MC\_ResetFollowingError (Reset Following Error Counter) instruction is executed.

### ● Execution of Other Instructions during Instruction Execution

The axis decelerates to a stop when this instruction is executed.

Execute an instruction for which multi-execution is supported while the axis is decelerating.

If an instruction for which multi-execution is not supported is executed, *CommandAborted* for the instruction changes to TRUE.

#### Relation to MC\_Stop Instruction

If the MC\_Stop instruction is executed during the MC\_ResetFollowingError (Reset Following Error Counter) instruction, *CommandAborted* from the MC\_ResetFollowingError (Reset Following Error Counter) instruction changes to TRUE. The MC\_Stop instruction is executed. However, *Deceleration* (Deceleration Rate) to the MC\_Stop instruction is not used and an immediate stop is performed.

## Errors

If an error occurs during instruction execution, *Error* will change to TRUE.

You can find out the cause of the error by referring to the value output by *ErrorID* (Error Code).

Timing charts for when the MC\_MoveAbsolute (Absolute Positioning) instruction is executed and an error occurs when the MC\_ResetFollowing Error is executed during holding status are given below.

MC\_MoveAbsolute instruction

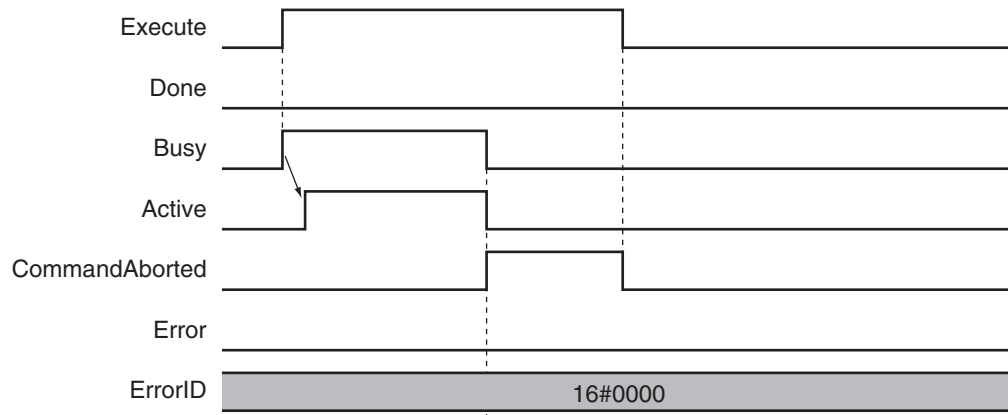

MC\_ResetFollowingError Instruction

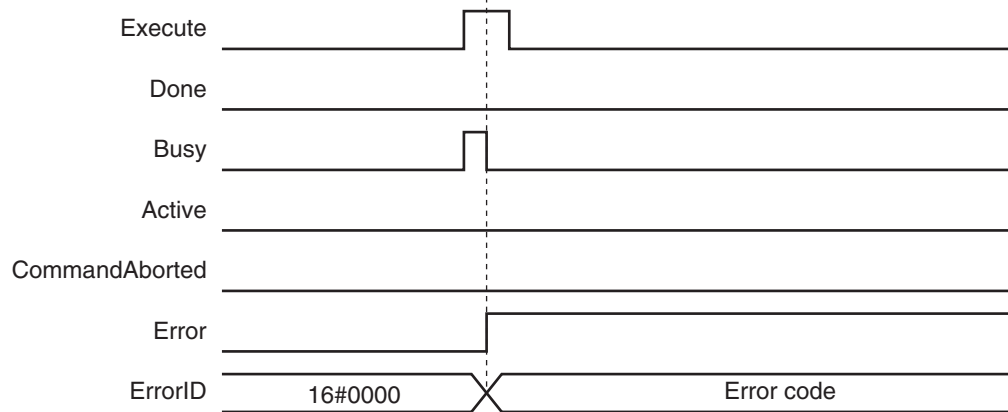

● Error Codes

Refer to the *NJ/NX-series Troubleshooting Manual (Cat. No. W503)* for instruction errors.

# MC\_CamIn

The MC\_CamIn instruction starts a cam operation by using a specified cam table.

Instruction	Name	FB/ FUN	Graphic expression	ST expression
MC_CamIn	Start Cam Operation	FB		<pre>MC_CamIn_instance (   Master :=parameter,   Slave :=parameter,   CamTable :=parameter,   Execute :=parameter,   Periodic :=parameter,   StartMode :=parameter,   StartPosition :=parameter,   MasterStartDistance :=parameter,   MasterScaling :=parameter,   SlaveScaling :=parameter,   MasterOffset :=parameter,   SlaveOffset :=parameter,   ReferenceType :=parameter,   Direction :=parameter,   CamTransition :=parameter,   BufferMode :=parameter,   InCam =&gt;parameter,   InSync =&gt;parameter,   EndOfProfile =&gt;parameter,   Index =&gt;parameter,   Busy =&gt;parameter,   Active =&gt;parameter,   CommandAborted =&gt;parameter,   Error :=parameter,   ErrorID =&gt;parameter );</pre>

## Variables

### Input Variables

Name	Meaning	Data type	Valid range	De- fault	Description
Execute	Execute	BOOL	TRUE or FALSE	FALS E	The instruction is executed when the value of this variable changes to TRUE.
Periodic	Periodic Mode	BOOL	TRUE or FALSE	FALS E	Specify whether to execute the specified cam table periodically or only once. TRUE: Periodic FALSE: Non-periodic

Name	Meaning	Data type	Valid range	Default	Description
StartMode	Start Mode	_eMC_START_MODE	0: _mcAbsolutePosition 1: _mcRelativePosition	0*1	Specify the coordinates used by <i>MasterStartDistance</i> . 0: Absolute position 1: Relative position
StartPosition	Cam Table Start Position	LREAL	Negative number, positive number, or 0	0	Specify the starting point of the cam table (0 phase) as an absolute position of the master axis. The unit is command units. *2
MasterStartDistance	Master Following Distance	LREAL	Negative number, positive number, or 0	0	Specify the position of the master axis when the slave axis starts the cam motion. When 0: <b>_mcAbsolutePosition</b> is specified with <i>StartMode</i> , specify the absolute position of the master axis. When 1: <b>_mcRelativePosition</b> is specified, specify a relative distance from the <i>StartPosition</i> (Cam Table Start Position). The unit is command units. *2
MasterScaling	Master Coefficient	LREAL	Positive value (> 0.0)	1.0	The phase of the master axis is extended or contracted by using the specified scale.
SlaveScaling	Slave Axis Coefficient	LREAL	Positive value (> 0.0)	1.0	The displacement of the slave axis is extended or contracted by using the specified scale.
MasterOffset	Master Offset	LREAL	Negative number, positive number, or 0	0	The phase of the master axis is shifted by using the specified offset value.
SlaveOffset	Slave Offset	LREAL	Negative number, positive number, or 0	0	The displacement of the slave axis is shifted by using the specified offset value.
ReferecneType	Position Type Selection	_eMC_REFERENCE_TYPE	0: _mcCommand 1: _mcFeedback 2: _mcLatestCommand	0 *1	Specify the position type of the master axis. 0: Command position (value calculated in the previous task period*3) 1: Actual position (value obtained in the same task period*3) 2: Command position (value calculated in the same task period*3)
Direction	Direction	_eMC_DIRECTION	0: _mcPositiveDirection 2: _mcNegativeDirection 4: _mcNoDirection	4 *1	The slave axis cam moves when the master axis moves in the specified direction only. If the master axis is moving opposite to the direction specified, the slave axis cam is stopped. 0: Positive direction 2: Negative direction 4: No direction specified

Name	Meaning	Data type	Valid range	Default	Description
CamTransition (Reserved)	Cam Transition Selection	_eMC_CAM_TRANSITION	0: _mcCTNone	0*1	(Reserved)
BufferMode	Buffer Mode Selection	_eMC_BUFFER_MODE	0: _mcAborting 1: _mcBuffered 2: _mcBlendingLow*4 3: _mcBlendingPrevious*4 4: _mcBlendingNext*4 5: _mcBlendingHigh*4	0*1	Specify the behavior when executing more than one motion instruction. 0: Aborting 1: Buffered 2: Blending low 3: Blending previous 4: Blending next 5: Blending high

- \*1. The default value for an enumeration variable is actually not the number, but the enumerator.
- \*2. Refer to *Unit Conversion Settings* in the *NJ/NX-series CPU Unit Motion Control User's Manual (Cat. No. W507)* for information on command units.
- \*3. The task period is the primary period if the task is the primary periodic task and the task period of the priority-5 periodic task if the task is the priority-5 periodic task.
- \*4. A CPU Unit with unit version 1.06 or later and Sysmac Studio version 1.07 or higher are required for these settings. The operation is the same regardless of which of the four types of blending is specified.

## Output Variables

Name	Meaning	Data type	Valid range	Unit	Description
InCam	Cam Motion	BOOL	TRUE or FALSE	---	TRUE when the cam table start point is executed.
InSync	In Sync	BOOL	TRUE or FALSE	---	TRUE when the cam is in operation.
EndOfProfile	End of Cam Cycle	BOOL	TRUE or FALSE	---	TRUE when the cam table end point is executed.
Index	Index	UINT	Nonnegative value	---	Contains the cam data index number. *1
Busy	Executing	BOOL	TRUE or FALSE	---	TRUE when the instruction is acknowledged.
Active	Controlling	BOOL	TRUE or FALSE	---	TRUE when the axis is being controlled.
CommandAborted	Command Aborted	BOOL	TRUE or FALSE	---	TRUE when the instruction is aborted.
Error	Error	BOOL	TRUE or FALSE	---	TRUE while there is an error.
ErrorID	Error Code	WORD	*2	---	Contains the error code when an error occurs. A value of 16#0000 indicates normal execution.

- \*1. The value is 0 while *InCam* (Cam Motion) is FALSE.
- \*2. The upper four digits of the event code give the error code for ErrorID. Refer to the *NJ/NX-series Troubleshooting Manual (Cat. No. W503)* for the event codes.

## ● Output Variable Update Timing

Name	Timing for changing to TRUE	Timing for changing to FALSE
InSync	When the slave axis starts cam operation.	<ul style="list-style-type: none"> <li>When <i>Periodic</i> is FALSE and <i>EndOfProfile</i> changes to TRUE.</li> <li>When <i>Error</i> changes to TRUE.</li> <li>When <i>CommandAborted</i> changes to TRUE.</li> </ul>
EndOfProfile	The period where the phase and displacement of the end point of the cam table are output as the command position.	One period after <i>EndOfProfile</i> changes to TRUE.
Busy	When <i>Execute</i> changes to TRUE.	<ul style="list-style-type: none"> <li>When <i>Periodic</i> is FALSE and <i>EndOfProfile</i> changes to TRUE.</li> <li>When <i>Error</i> changes to TRUE.</li> <li>When <i>CommandAborted</i> changes to TRUE.</li> </ul>
InCam	When the master axis passes the <i>StartPosition</i> (Cam Table Start Position).	<ul style="list-style-type: none"> <li>When <i>Periodic</i> is FALSE and <i>EndOfProfile</i> changes to TRUE.</li> <li>When <i>Error</i> changes to TRUE.</li> <li>When <i>CommandAborted</i> changes to TRUE.</li> </ul>
Active	When the instruction is started.	<ul style="list-style-type: none"> <li>When <i>Periodic</i> is FALSE and <i>EndOfProfile</i> changes to TRUE.</li> <li>When <i>Error</i> changes to TRUE.</li> <li>When <i>CommandAborted</i> changes to TRUE.</li> </ul>
CommandAborted	<ul style="list-style-type: none"> <li>When this instruction is aborted because another motion control instruction was executed with the Buffer Mode set to <b>Aborting</b>.</li> <li>When this instruction is canceled due to an error.</li> <li>When this instruction is executed while there is an error.</li> <li>When you start this instruction during MC_Stop instruction execution.</li> <li>When the MC_CamOut instruction is executed.</li> </ul>	<ul style="list-style-type: none"> <li>When <i>Execute</i> is TRUE and changes to FALSE.</li> <li>After one period when <i>Execute</i> is FALSE.</li> </ul>
Error	When there is an error in the execution conditions or input parameters for the instruction.	When the error is cleared.

## In-Out Variables

Name	Meaning	Data type	Valid range	Description
Master	Master Axis	_sAXIS_REF	---	Specify the master axis. *1
Slave	Slave Axis	_sAXIS_REF	---	Specify the slave axis. *1
CamTable	Cam Table	ARRAY[0..N] OF _sMC_CAM_REF	---	Specify the cam data structure _sMC_CAM_REF array variable as the cam table. *2

\*1. Specify a user-defined Axis Variable that was created in the Axis Basic Settings of the Sysmac Studio (default: MC\_Axis\*) or a system-defined axis variable name (\_MC\_AX[\*], \_MC1\_AX[\*], or \_MC2\_AX[\*]).

If you use Sysmac Studio version 1.29 or higher, you can specify the system-defined axis variable name for AT specification of a user-defined variable. This will allow you to specify the user-defined variable.

If you use Sysmac Studio version 1.28 or lower, do not specify any user-defined variable created in the variable table.

\*2. "N" in the array variable is set automatically by the Sysmac Studio. Specify a cam data variable that was created on Cam Editor of the Sysmac Studio.



**Precautions for Correct Use**

If you specify the same axis for the master axis and slave axis, a Master and Slave Defined as Same Axis minor fault (error code 5436 hex) will occur.

**Function**

- The MC\_CamIn instruction executes a cam motion that synchronizes the master axis phase and slave axis displacement according to a cam table.
- You must create the cam table specified for this instruction by using the Cam Editor and download it to the Controller in advance.
- This instruction is executed when *Execute* changes to TRUE.

**Precautions for Correct Use**

For the cam table, you must use a cam data variable that was created on the Cam Editor of the Sysmac Studio.

**Additional Information**

Use the Synchronize Menu of the Sysmac Studio to download the project.

For details on cam tables, refer to the *NJ/NX-series CPU Unit Motion Control User's Manual (Cat. No. W507)*.

Specify the phases and displacements in the cam table as relative quantities from a start point of 0.0.

Cam Table

	Phase	Displacement	
Start point →	0	0	← Index = 0
Cam data →	60	200	1
	120	100	2
	180	300	3
	240	100	4
	300	200	5
End point →	360	0	6

The command positions for the master and slave axes are linear interpolations between two cam data where the slave axis displacement corresponding to the master axis phase is calculated.

If there are only a few cam data, the intervals between phases are large and cam operation will not be very precise. If there are many cam data, the intervals between phases are small and cam operation will be very precise.

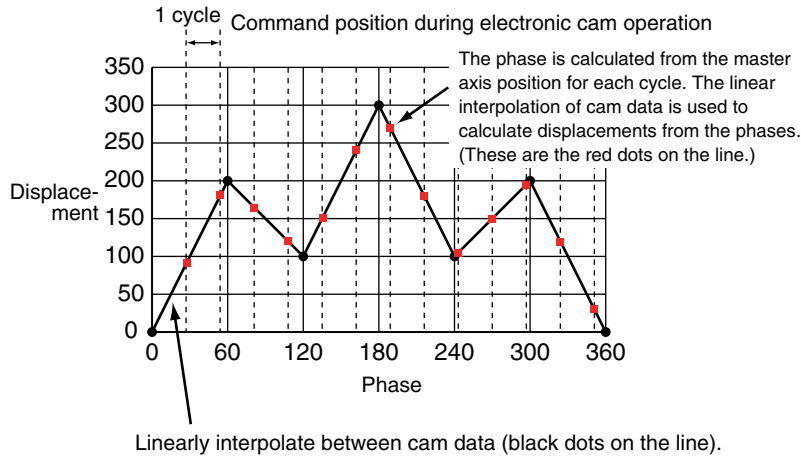

### Precautions for Correct Use

- Do not execute the MC\_SetPosition instruction for the *Master* (Master Axis) if you use this instruction on a CPU Unit with unit version 1.09 or earlier. If the MC\_SetPosition instruction is executed for the *Master* (Master Axis), the *Slave* (Slave Axis) may follow the master axis quickly.

If you want to use the MC\_SetPosition instruction for the *Master* (Master Axis), disable the relationship between the *Master* (Master Axis) and *Slave* (Slave Axis) before executing the instruction.

Refer to 1-1-3 Precautions for Master and Auxiliary Axes in Synchronized Control on page 1-6 for precautions on the master axis.
- When executed, this instruction checks if the phases are in ascending order. If they are not in ascending order, an error occurs.

When you change cam data, execute the MC\_SetCamTableProperty (Set Cam Table Properties) instruction to make sure that the phases are in ascending order.

Make sure that the phases will be in ascending order before you change the phases during a cam motion. The cam motion may stop if the phases are not in ascending order.
- Cam data variables are global variables. You can therefore access or change the values of cam data variables from more than one task. If you change the values of cam data variables from more than one task, program the changes so that there is no competition in writing the value from more than one task.
- If you use exclusive control of global variables between tasks for a cam data variable, do not use the cam data variable for motion control instructions while exclusive control is in effect for the cam data variable. An Incorrect Cam Table Specification error (error code: 5439 hex) will occur.
- If a cam table is switched by re-executing the instruction during a cam motion, the velocity or acceleration of the slave axis may change rapidly before or after the cam table is switched. Since this may affect the mechanical machine, be sure to thoroughly verify that there will be no excessive changes in velocity or acceleration before switching the cam table.
- When the value of the cam data variable included in the cam table is changed from the user program during a cam motion, the velocity and acceleration of the slave axis may change rapidly before and after the change.

Since this may affect the mechanical machine, be sure to thoroughly verify that there will be no excessive changes in velocity or acceleration before changing the value of the cam data variable.

## Instruction Details

This section describes the instruction in detail.

### ● Instruction Execution Condition

You can execute this instruction while the master axis is stopped, during position control, velocity control, or synchronized control.

For details on the slave axis, refer to *Re-execution of Motion Control Instructions* on page 3-199 and *Multi-execution of Motion Control Instructions* on page 3-6.

### ● Software Limits

If the slave axis exceeds the software limit during cam operation, an error occurs.

### ● Cam Data Variables

A cam data variable is declared as an array of cam data structures. The type declaration for the cam data structure is shown below.

```

TYPE
  (*Cam data structure*)
  _sMC_CAM_REF :
  STRUCT
    Phase : REAL; (*Phase*)
    Distance : REAL; (*Displacement*)
  END_STRUCT;
END_TYPE

```

Create the cam data variables on the Sysmac Studio.

You can specify a name for the cam table name (i.e., the name of the cam data variable).

For example, if you make a cam table called *MyCam1* with 1,000 points, use the following variable declaration, which is automatically made by the Sysmac Studio.

```

VAR
  (*Cam table*)
  MyCam1: ARRAY [0..999] OF _sMC_CAM_REF;
END_VAR

```

The following notation is used to specify *MyCam1* for this instruction. In this example, the master axis is *Axis1* and the slave axis is *Axis2*.

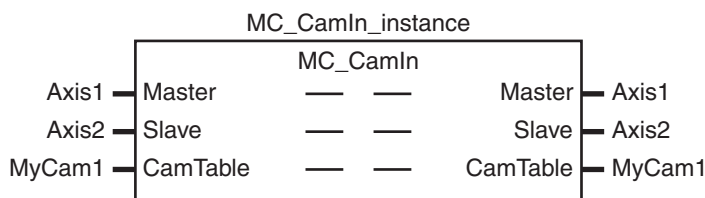

An error will occur if the specified cam table does not exist in the Controller. You can also specify the same cam table for more than one axis.

The values in cam data variables can be written from the user program. However, any changes to the values are lost when the power supply to the Controller is turned OFF or the cam data variables are downloaded from the Sysmac Studio.

The values that are downloaded from the Sysmac Studio are always used when the power supply to the CPU Unit is turned ON or after the cam data variables are downloaded. To save any changes, execute the `MC_SaveCamTable` instruction.

Changes to the cam data variables are retained when the operating mode of the CPU Unit is changed.



#### Additional Information

- The cam data variables are not published to the network.  
For example, you can monitor the values of *MyCam1[10].Phase* or *MyCam1[10].Distance* from the Sysmac Studio, but you cannot access from any other Controllers via EtherNet/IP.
- Use the Synchronize Menu of the Sysmac Studio to download the project.

### ● Starting Cam Operation

After the instruction starts, the master axis has to reach the *StartPosition* (Cam Table Start Position). After the master axis passes the *StartPosition* (Cam Table Start Position), the start point in the cam table is executed and the *InCam* output variable (Cam Motion) changes to TRUE.

Relative amounts are applied to the phase and displacements in the cam table so that the start point is zeroed. The absolute position of each axis at each phase is the relative value from the absolute position of the axis at the start point of the cam table. For example, if the Count Mode of the master axis is 0° to 360° in **Rotary Mode**, the *StartPosition* (Cam Table Start Position) is 60. The absolute position of the master axis is the phase added to the *StartPosition* (Cam Table Start Position), as shown in the following cam table. The absolute position of the slave axis is the displacement from the cam table added to the absolute position of the slave axis at the start point of the cam table.

Cam Table			Absolute Position of Axes	
	Phase	Displacement	Master axis	Slave axis
Start point →	0	0	60	0 + Absolute position of slave axis at start point of cam table
Cam data →	60	200	120	200 + Absolute position of slave axis at start point of cam table
	120	100	180	100 + Absolute position of slave axis at start point of cam table
	180	300	240	300 + Absolute position of slave axis at start point of cam table
	240	100	300	100 + Absolute position of slave axis at start point of cam table
	300	200	360	200 + Absolute position of slave axis at start point of cam table
End point →	360	0	60	0 + Absolute position of slave axis at start point of cam table

StartPosition=60

When the *MasterStartDistance* (Master Following Distance) is then passed, the cam operation of the slave axis starts and the *InSync* output variable changes to TRUE.

The *MasterStartDistance* (Master Following Distance) is specified either as an absolute position, or as a relative distance from the *StartPosition* (Cam Table Start Position). Set whether to specify using an absolute position or relative position with *StartMode*.

#### Example 1: Differences in Slave Axis Operation for Differences in *MasterStartDistance*

In this example, the same cam table and same master axis are used.

The cam table settings are given in the following table.

Master axis	Slave axis	Cam curve	Connecting velocity	Connecting acceleration	Phase pitch
0.000	0.000	---	---	---	---
80.000	80.000	Straight line	360.000	0.000	0.010
120.000	200.000	Straight line	1080.000	0.000	0.010
360.000	360.000	Straight line	240.000	0.000	0.010

The conditions for starting cam operation are given in the following table.

Input variable	Condition 1	Condition 2
Periodic (Periodic Mode)	TRUE: Periodic	TRUE: Periodic
StartMode	_mcRelativePosition (Relative Position)	_mcRelativePosition (Relative Position)
StartPosition (Cam Table Start Position)	0	0
MasterStartDistance (Master Following Distance)	0	80

For condition 1, the *InCam* (Cam Motion) and *InSync* output variables both change to TRUE and the slave axis starts cam operation when the master axis passes 0°.

For condition 2, the *InCam* (Cam Motion) changes to TRUE when the master axis passes 0°. Then, the *InSync* output variable changes to TRUE and the slave axis starts cam operation when the master axis passes 80° \*1. For condition 2, cam operation starts in the middle of the cam table, so the slave axis will accelerate rapidly.

\*1. Because *StartMode* is set to *\_mcRelativePosition*, the cam operation starts at *StartPosition* + *MasterStartDistance*, or 80°.

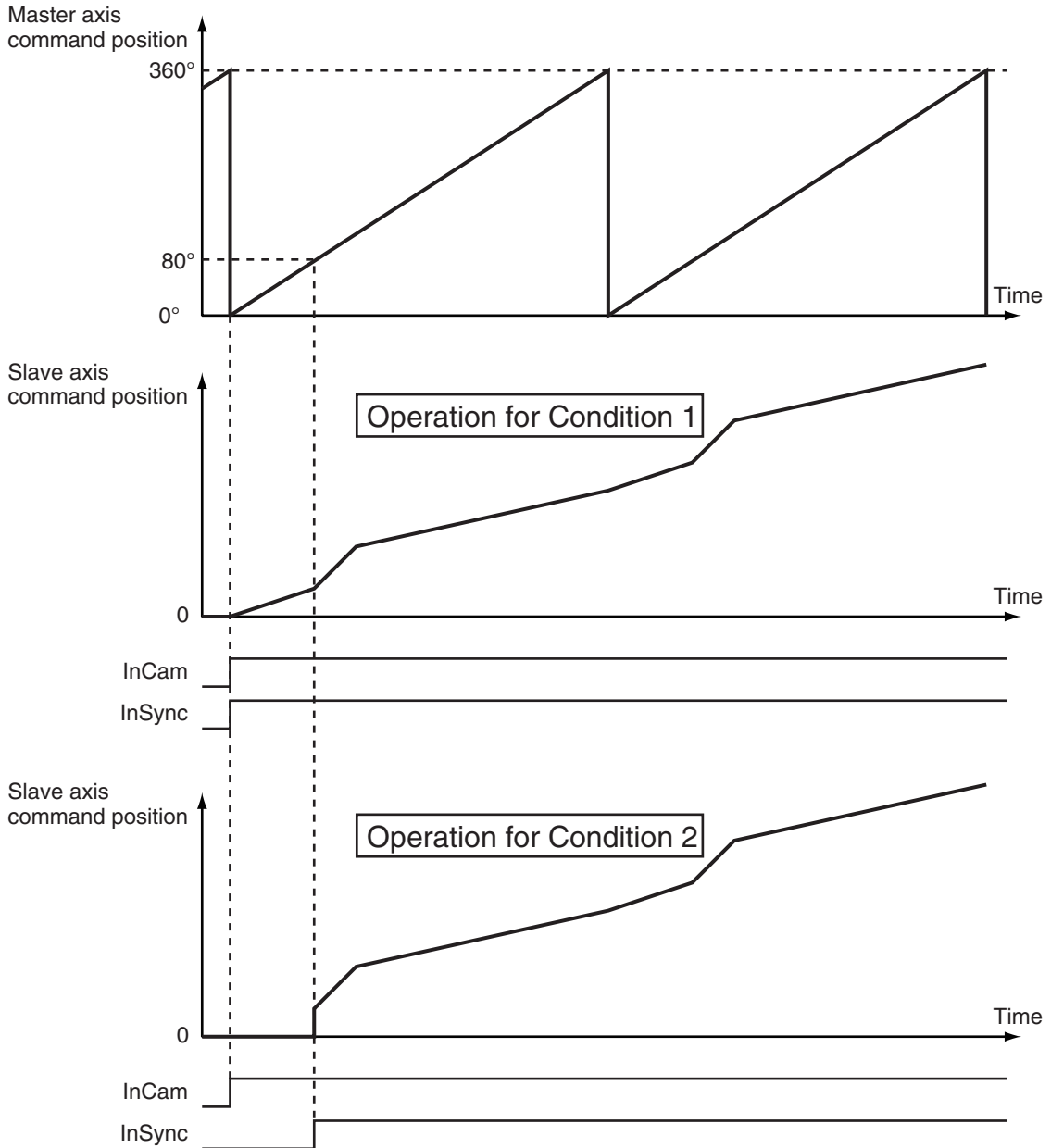



### Additional Information

For condition 2, the slave axis will accelerate rapidly if *SlaveOffset* is set to 0.

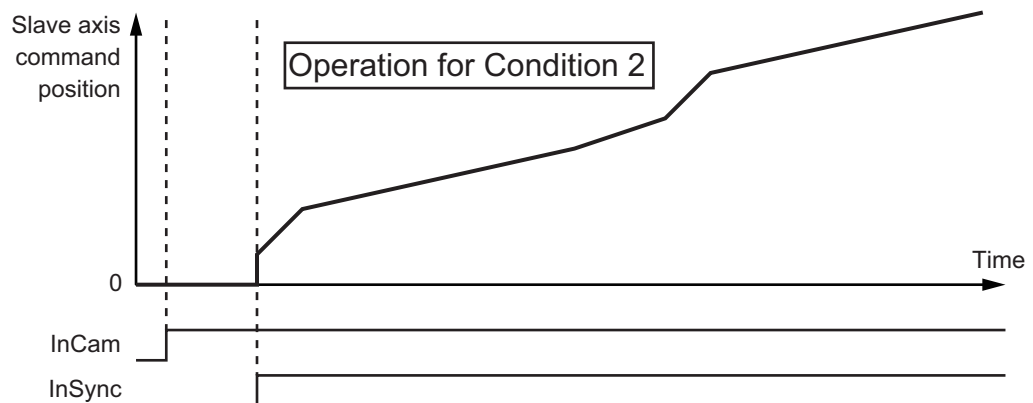

If *SlaveOffset* is set to -80, the slave axis starts synchronization from a displacement of *MasterStartDistance* (Master Following Distance) and rapid acceleration is prevented.

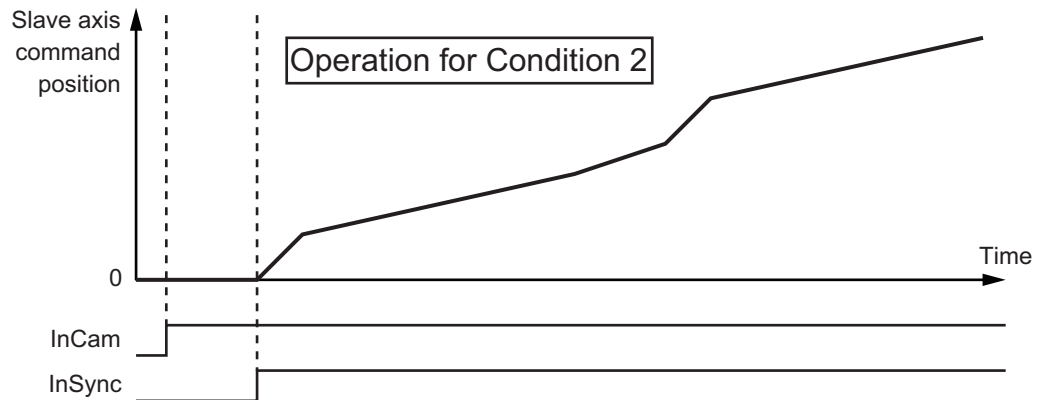

### Example 2: Differences in Slave Axis Operation for Differences in *StartPosition* and *MasterStartDistance*

The cam table settings are the same as in the previous example. The conditions for starting cam operation are given in the following table.

Input variable	Condition 1	Condition 2	Condition 3
Periodic (Periodic Mode)	TRUE: Periodic	TRUE: Periodic	TRUE: Periodic
StartMode	<i>_mcRelativePosition</i> (Relative Position)	<i>_mcRelativePosition</i> (Relative Position)	<i>_mcRelativePosition</i> (Relative Position)
StartPosition (Cam Table Start Position)	0	40	40
MasterStartDistance (Master Following Distance)	0	0	80

For condition 1, the *InCam* (Cam Motion) and *InSync* output variables both change to TRUE and the slave axis starts cam operation when the master axis passes 0°.

For condition 2, the *InCam* (Cam Motion) and *InSync* output variables both change to TRUE and the slave axis starts cam operation when the master axis passes 40° (the value that is specified for *StartPosition* (Cam Table Start Position)).

For condition 3, the *InCam* (Cam Motion) changes to TRUE when the master axis passes 40°. Then, the *InSync* output variable changes to TRUE and the slave axis starts cam operation when the master axis passes 120° \*1.

\*1. Because *StartMode* is set to *\_mcRelativePosition*, the cam operation starts at *StartPosition + MasterStartDistance*, or 120°.

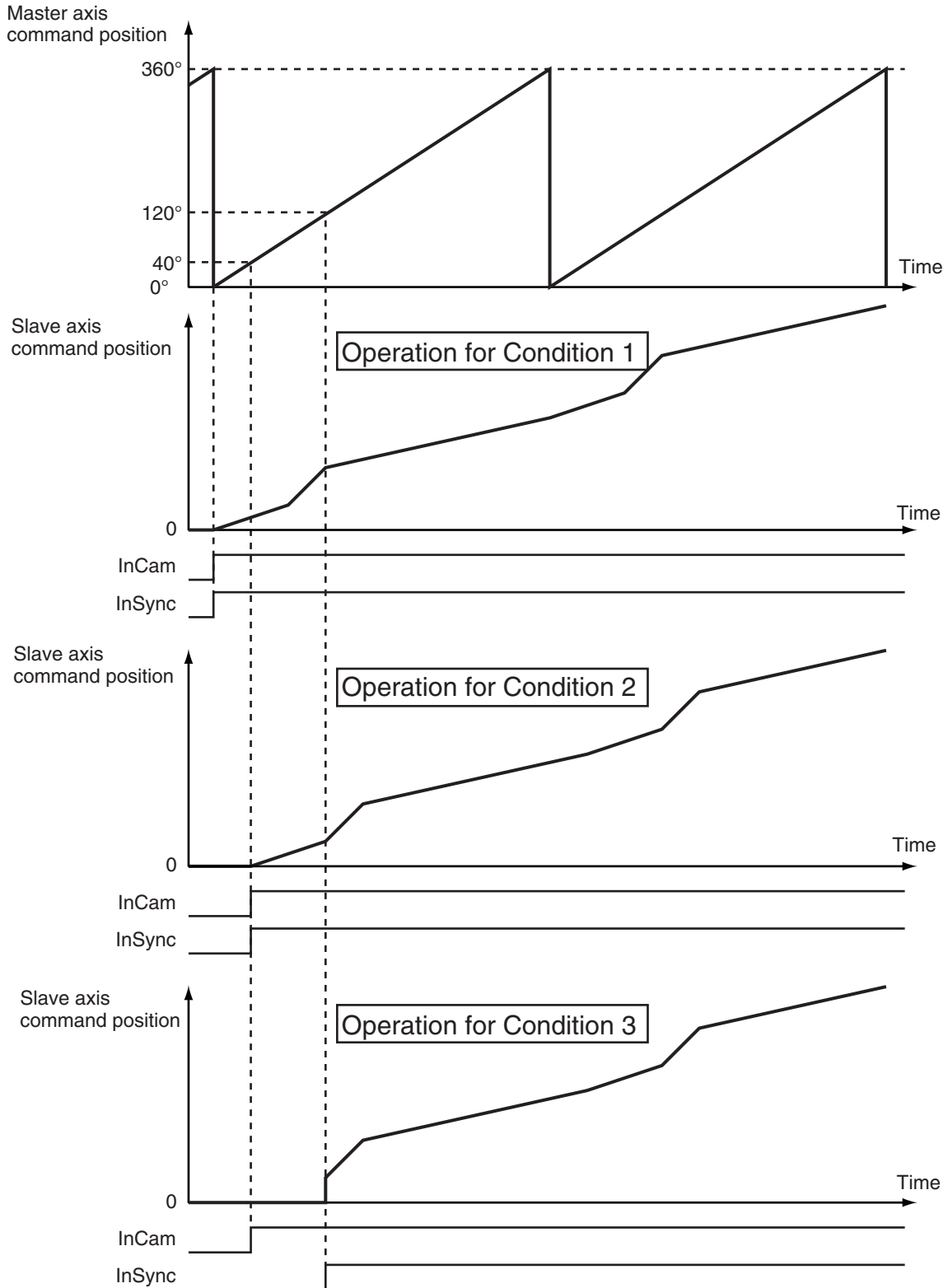



### Example 3: Differences in Starting Cam Operation of the Slave Axis for Differences in *StartMode*

You can use *StartMode* to specify whether the value that is specified for *MasterStartDistance* (Master Following Distance) is treated as an absolute value or a relative value.

This example describes the differences in starting cam operation of the slave axis for differences in *StartMode*. The cam table settings are the same as in the previous example.

The conditions for starting cam operation are given in the following table.

Input variable	Condition 1	Condition 2
Periodic (Periodic Mode)	TRUE: Periodic	TRUE: Periodic
<i>StartMode</i>	<code>_mcAbsolutePosition</code> (Absolute Position)	<code>_mcRelativePosition</code> (Relative Position)
<i>StartPosition</i> (Cam Table Start Position)	40	40
<i>MasterStartDistance</i> (Master Following Distance)	80	80

For both conditions 1 and 2, the *InCam* (Cam Motion) output variable changes to TRUE when the master axis passes 40°. For condition 1, *StartMode* is set to `_mcAbsolutePosition` (absolute position), so the *InSync* output variable changes to TRUE and the slave axis starts cam operation when the master axis passes 80°.

For condition 2, *StartMode* is set to `_mcRelativePosition` (relative position), so the *InSync* output variable changes to TRUE and the slave axis starts cam operation when the master axis passes 120° (= 40° + 80°).

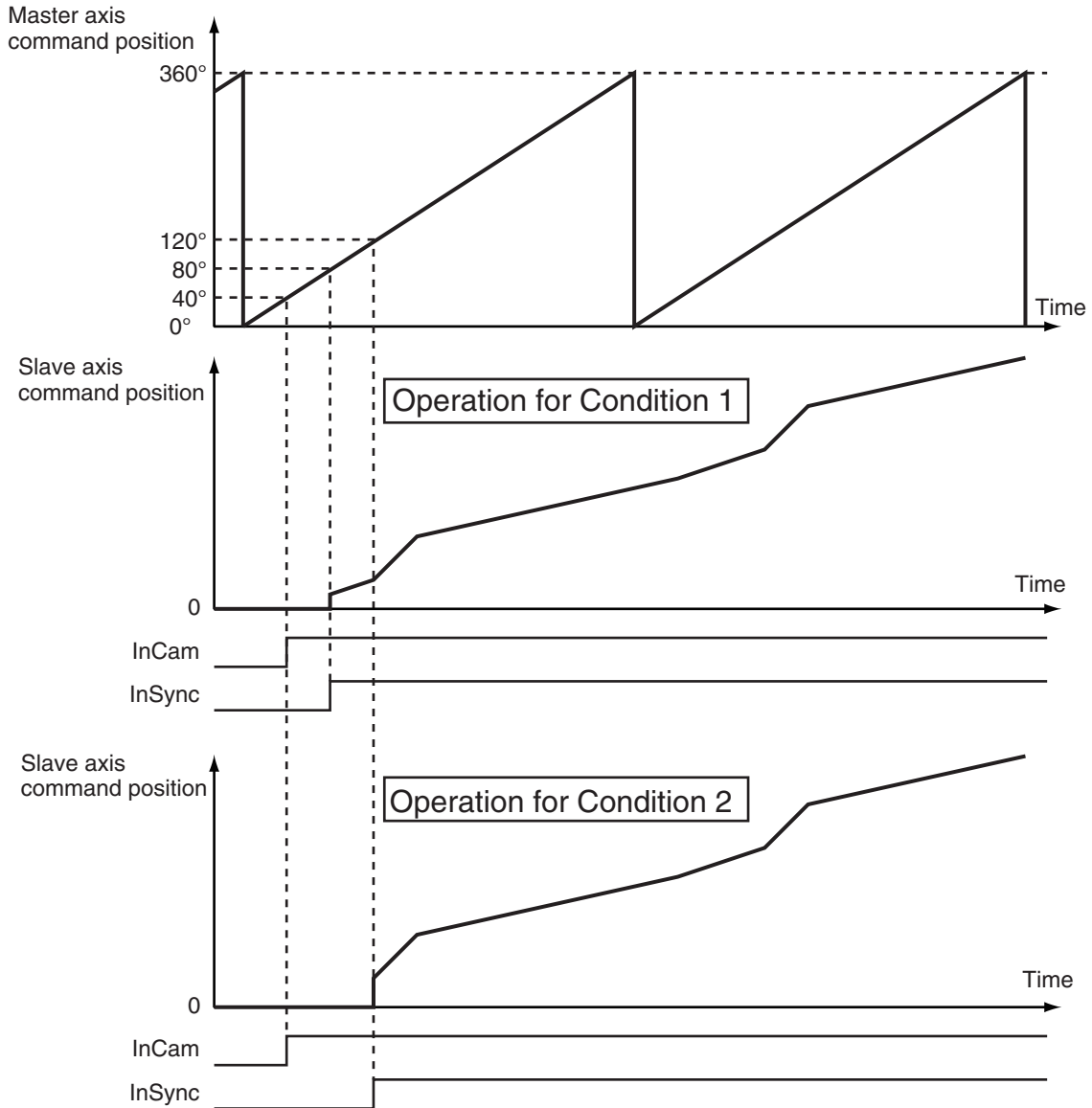

### Precautions for Correct Use

To perform a cam motion, use the Cam Editor in the Sysmac Studio to create a cam profile and then download the cam profile to the CPU Unit.  
Use the Synchronize Menu of the Sysmac Studio to download the project.

### ● Periodic (Periodic Mode)

If you specify TRUE (periodic) for *Periodic*, the cam motion will be repeated from the start to the end point of the cam table.

If you specify FALSE (non-periodic), the cam operation ends when the last point in the cam table is executed.

If the stroke position of the slave axis is the same at the start and end points of the cam table when TRUE (periodic) is set, the cam operates as a reciprocal cam. (Refer to *Reciprocal Cam Operation* below.) If the stroke position of the slave axis differs at the start point and end point, the cam operates as a feeding cam. (Refer to *Feeding Cam Operation* below.)

In the following chart, the horizontal axis indicates the master axis and the vertical axis indicates the slave axis.

### Reciprocal Cam Operation

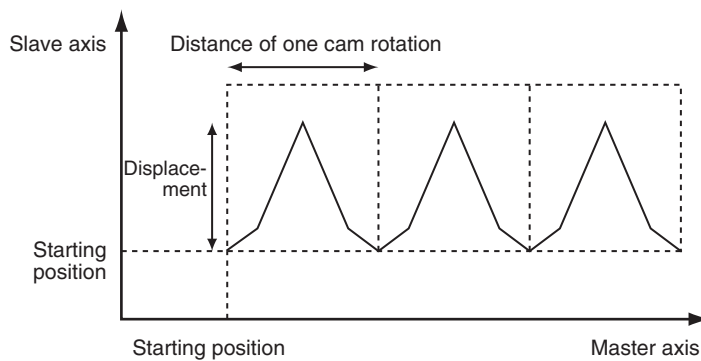

### Feeding Cam Operation

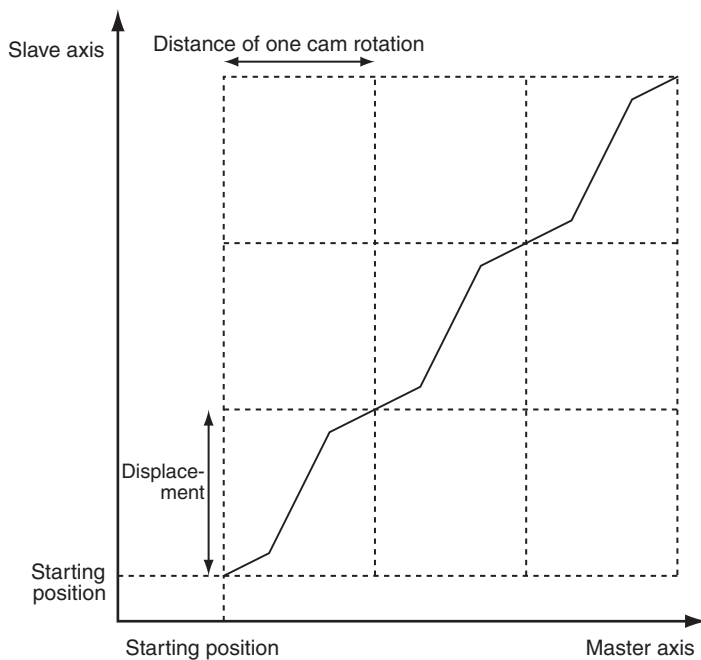

- **EndOfProfile (End of Cam Cycle)**

*EndOfProfile* (End of Cam Cycle) is TRUE for one period when the command value of the cam motion for the phase and displacement defined by the end point in the cam table is output.

Set the absolute position of the master axis as the *StartPosition* (Cam Table Start Position) and the cam table becomes relative to that position.

*EndOfProfile* (End of Cam Cycle) functions as an output indicating the end of the cam table.

- **Ending Cam Operation**

Use the MC\_CamOut (End Cam Operation) instruction or MC\_Stop instruction to stop cam operation before it is completed.

- **Scaling Factor**

You can specify a scaling factor to scale up or scale down the master axis phase and slave axis displacement of a specified cam table.

You can apply separate factors to the master and slave axes.

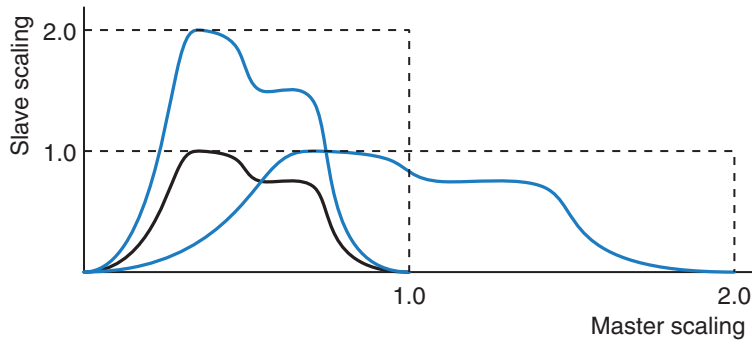

● **Offset**

You can shift the phase and displacement by an offset from the specified cam table. You can specify separate offsets for the master axis phase and slave axis displacement.

**MasterOffset > 0**

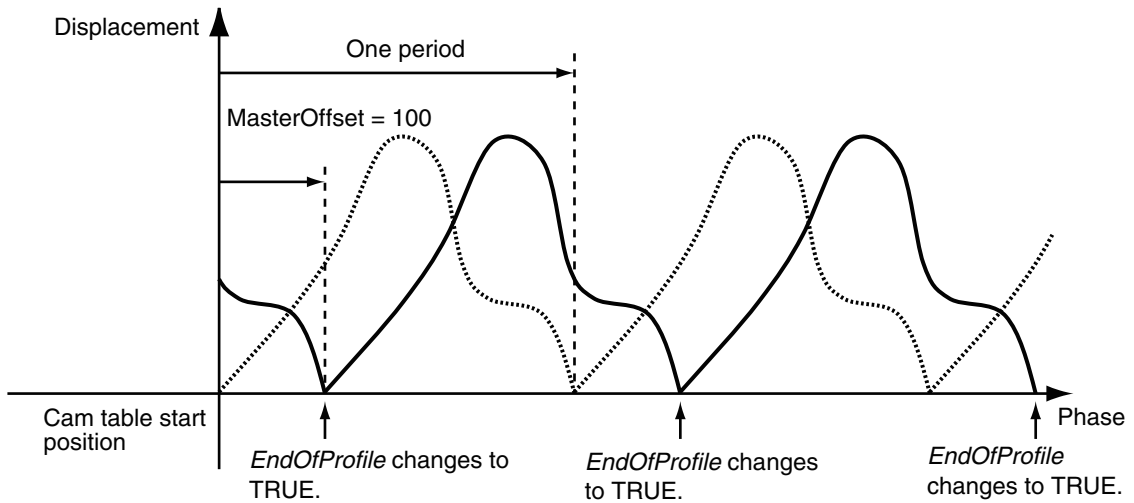

**MasterOffset < 0**

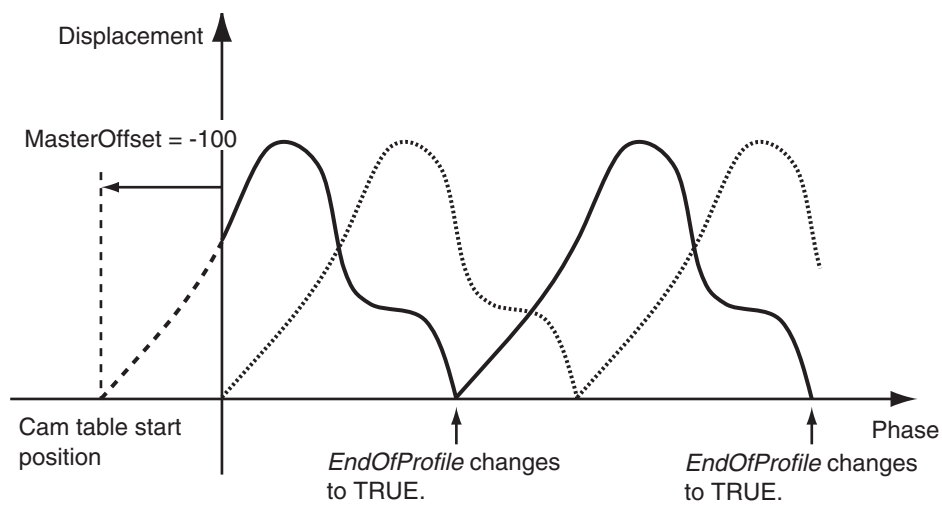

**SlaveOffset > 0**

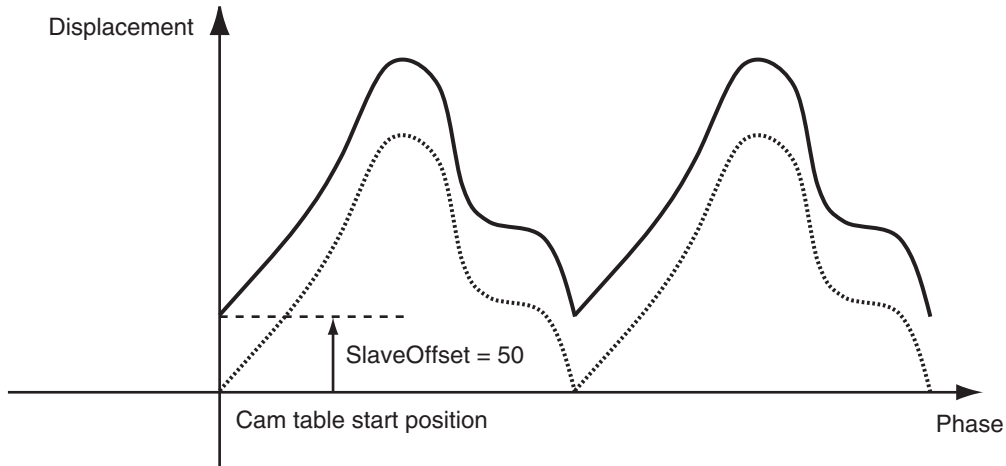

### SlaveOffset < 0

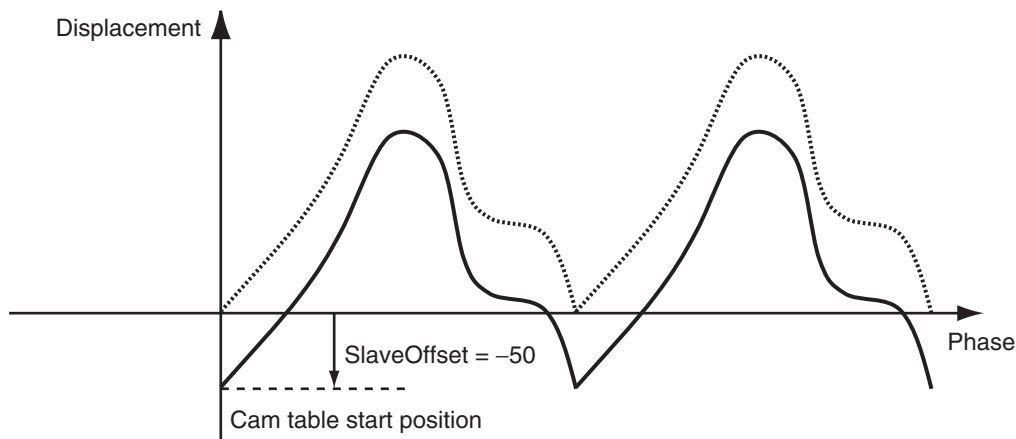

## ● ReferenceType (Position Type Selection)

Any of the following position types can be selected for the master axis to which the slave axis is synchronized.

- `_mcCommand`: Command position (value calculated in the previous task period)  
The master axis command position that was calculated in the previous task period is used for the current period.  
The command value that was calculated for the master axis in the last periodic task is used to calculate the command position of the slave axis in the current period.
- `_mcFeedback`: Value obtained in the same task period  
The actual position of the master axis that was obtained in the same task period is used.
- `_mcLatestCommand`: Command position (value calculated in the same task period)  
The command position of the master axis that was calculated in the same task period is used.  
This enables the use of information that is more recent than for `_mcCommand`. However, the axis number of the master axis must be set lower than the axis number of the slave axis.  
If the axis number of the slave axis is lower than the axis number of the master axis, *Error* will change to TRUE. A Master/Slave Axis Numbers Not in Ascending Order error (error code: 5438 hex) will be output to *ErrorID*.



### Precautions for Correct Use

Here, the task period is the primary period if the task is the primary periodic task and the task period of the priority-5 periodic task if the task is the priority-5 periodic task. In the same way, the periodic task is the primary periodic task or the priority-5 periodic task.



### Additional Information

The command position that is calculated in the same task period enables greater precision in synchronization than the command position that was calculated in the previous task period. However, the axis number set for the *Master* (Master Axis) in the system-defined variable for motion control must be lower than the axis number set for the *Slave* (Slave Axis) in the system-defined variable for motion control.

## ● Relationship between Axis Types and Position Types

The relationship between the axis types that you can monitor and position types that is monitored is shown below.

Axis Type	ReferenceType	
	<code>_mcCommand</code> or <code>_mcLatestCommand</code>	<code>_mcFeedback</code>
Servo axis	OK	OK
Encoder axis	No *1	OK
Virtual servo axis	OK	OK
Virtual encoder axis	No *1	OK

\*1. A Position Type Selection Out of Range error (error code: 5430 hex) occurs when the instruction is executed.

## ● Direction

You can start cam operation for the slave axis only if the travel direction of the master axis matches the setting in *Direction*.

*Direction* is valid only while *InSync* is TRUE.

### `_mcNoDirection` (No Direction Specified)

Cam operation starts regardless of whether the master axis is traveling in the positive or negative direction.

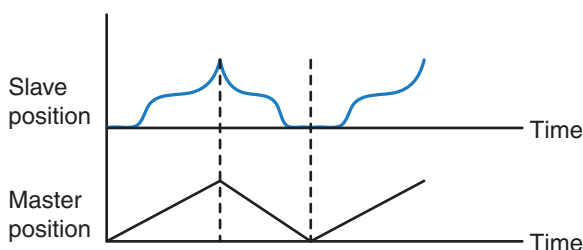

### `_mcPositiveDirection`

Cam operation starts when the master axis is moving in the positive direction.

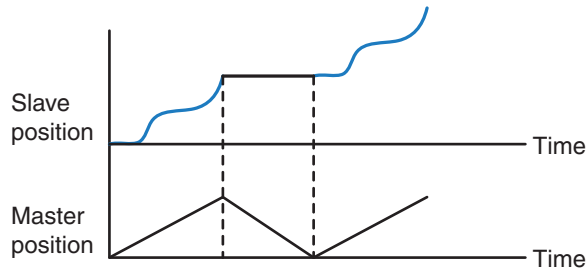

**\_mcNegativeDirection**

Cam operation starts when the master axis is moving in the negative direction.

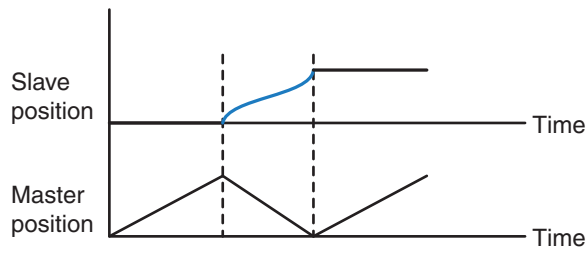



**Version Information**

If *MasterStartDistance* (Master Following Distance) is exceeded while the master axis is moving in the opposite direction from *Direction* (Direction) and *InSync* (In Sync) changes to TRUE, the operation depends on the unit version of the CPU Unit as follows:

• **CPU Units with Unit Version 1.10 or Later**

When *InSync* (In Sync) changes to TRUE, the slave axis moves to the displacement according to the phase in the cam table. If the master axis then moves in the direction specified in *Direction* (Direction), the slave axis starts cam operation.

• **CPU Units with Unit Version 1.09 or Earlier**

If the master axis moves in the direction specified in *Direction* (Direction) after *InSync* (In Sync) changes to TRUE, the slave axis starts cam operation.

An example is given below. The cam table settings are the same as in the previous example. The conditions for starting cam operation are given in the following table.

Input variable	Condition
StartMode (Start Mode)	_mcAbsolutePosition (Absolute Position)
Direction (Direction)	_mcPositiveDirection (Positive Direction)
StartPosition (Cam Table Start Position)	0
MasterStartDistance (Master Following Distance)	80

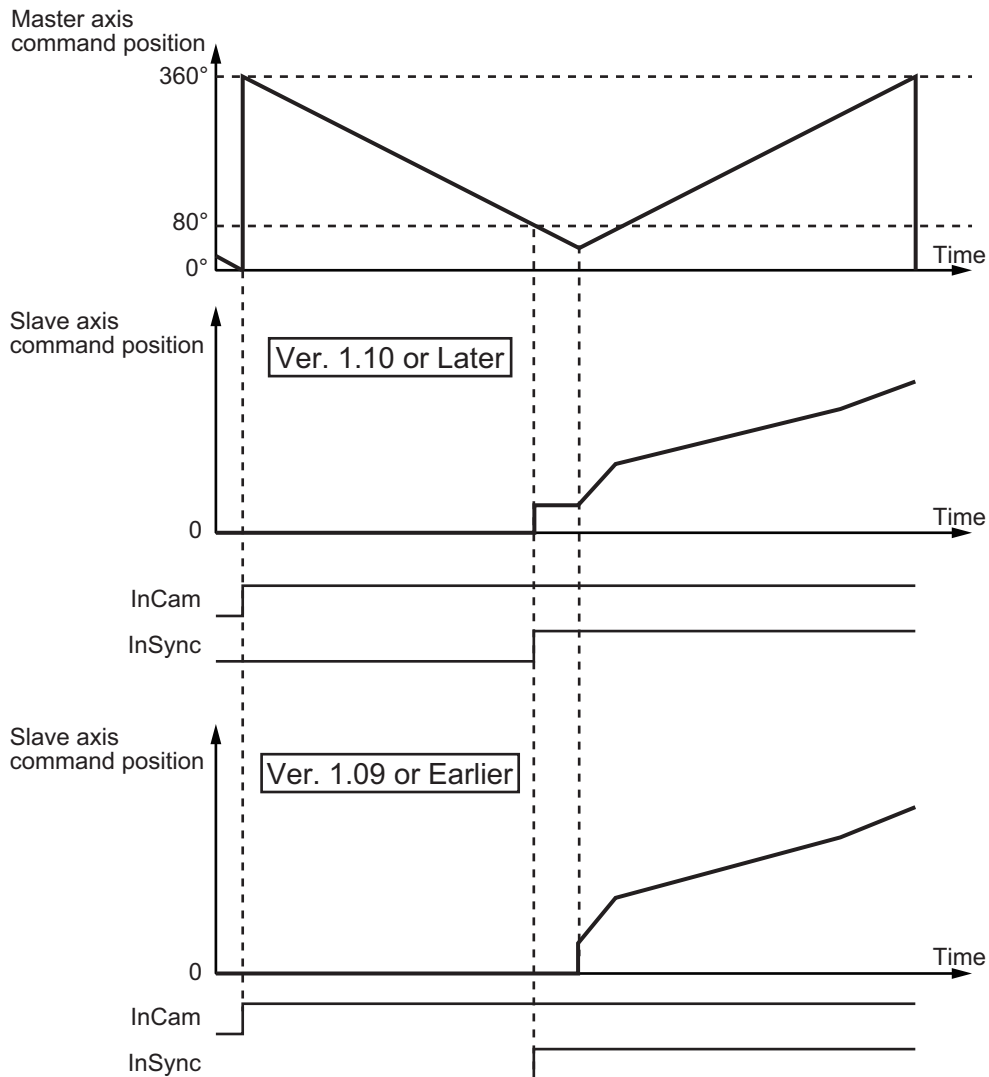



## ● BufferMode (Buffer Mode Selection)

This variable specifies how to join the axis motions for this instruction and the previous instruction. There are the following six settings.

Buffer Mode Selection	Description
Aborting	<p>Cancels the instruction being executed and switches to this instruction. When the master axis passes <i>StartPosition</i> (Cam Table Start Position) and then passes <i>MasterStartDistance</i> (Master Following Distance), the cam operation of the slave axis starts and the <i>InSync</i> output variable changes to TRUE.</p> <p>The slave axis remains stopped until the <i>InSync</i> output variable to the buffered instruction changes to TRUE.</p> <p>The starting point in the cam table is specified by <i>StartPosition</i> (Cam Table Start Position).</p>
Buffered	<p>The buffered instruction is executed automatically starting from the period in which the current instruction is completed normally. When the master axis passes <i>StartPosition</i> (Cam Table Start Position) and then passes <i>MasterStartDistance</i> (Master Following Distance), the cam operation of the slave axis starts and the <i>InSync</i> output variable changes to TRUE.</p> <p>The slave axis remains stopped until the <i>InSync</i> output variable to the buffered instruction changes to TRUE.</p> <p>The starting point in the cam table is specified by <i>StartPosition</i> (Cam Table Start Position).</p>
Blending *1	<p>The <i>InSync</i> output variable from the buffered instruction changes to TRUE in the period in which the current instruction is completed normally, and cam operation starts without the slave axis ever stopping.</p> <p>Even if <i>StartPosition</i> (Cam Table Start Position) and <i>MasterStartDistance</i> (Master Following Distance) are specified for the buffered instruction, the slave axis starts cam operation as soon as instruction execution starts regardless of the values that are specified.</p> <p>The starting point in the cam table is the final position for the current instruction.</p>
Blending low	
Blending previous	
Blending next	
Blending high	

\*1. A CPU Unit with unit version 1.06 or later and Sysmac Studio version 1.07 or higher are required for these settings.

The operation is the same regardless of which of the four types of blending is specified.

For details on *BufferMode* (Buffer Mode Selection), refer to the *NJ/NX-series CPU Unit Motion Control User's Manual (Cat. No. W507)*.

## ● Multi-execution of Instructions with Buffer Mode in Buffered

Consider the case of multi-execution of instructions where MC\_CamIn2 is executed with the Buffer Mode set to **Buffered** during execution of MC\_CamIn1. After execution of MC\_CamIn1 is completed and *Active* (Controlling) to MC\_CamIn2 changes to TRUE, *InSync* changes to TRUE at the next *StartPosition* (Cam Table Start Position) and cam operation starts.

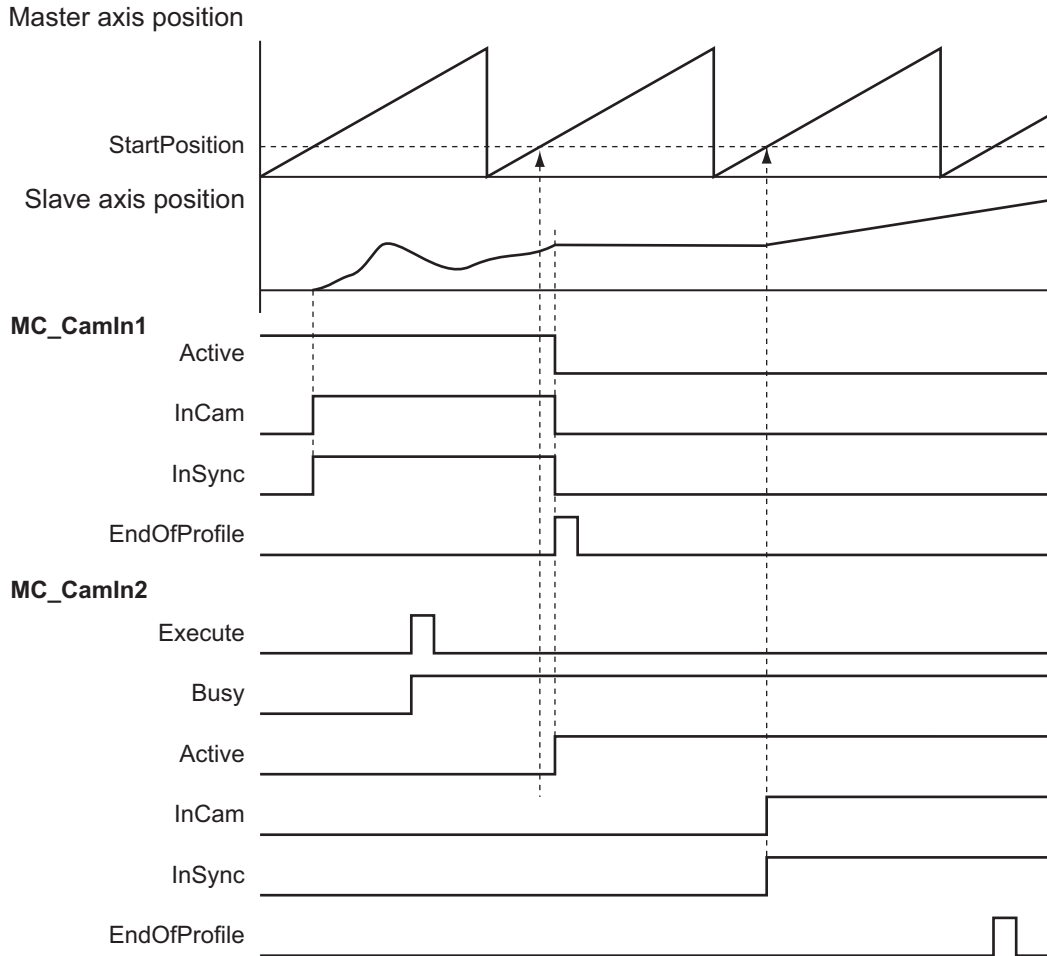

● **Multi-execution of Instructions with Buffer Mode in Blending**

Consider the case of multi-execution of instructions where MC\_CamIn2 is executed with the Buffer Mode set for **Blending** during execution of MC\_CamIn1. In the same period in which execution of MC\_CamIn1 is completed, *InSync* from MC\_CamIn2 changes to TRUE and cam operation starts.

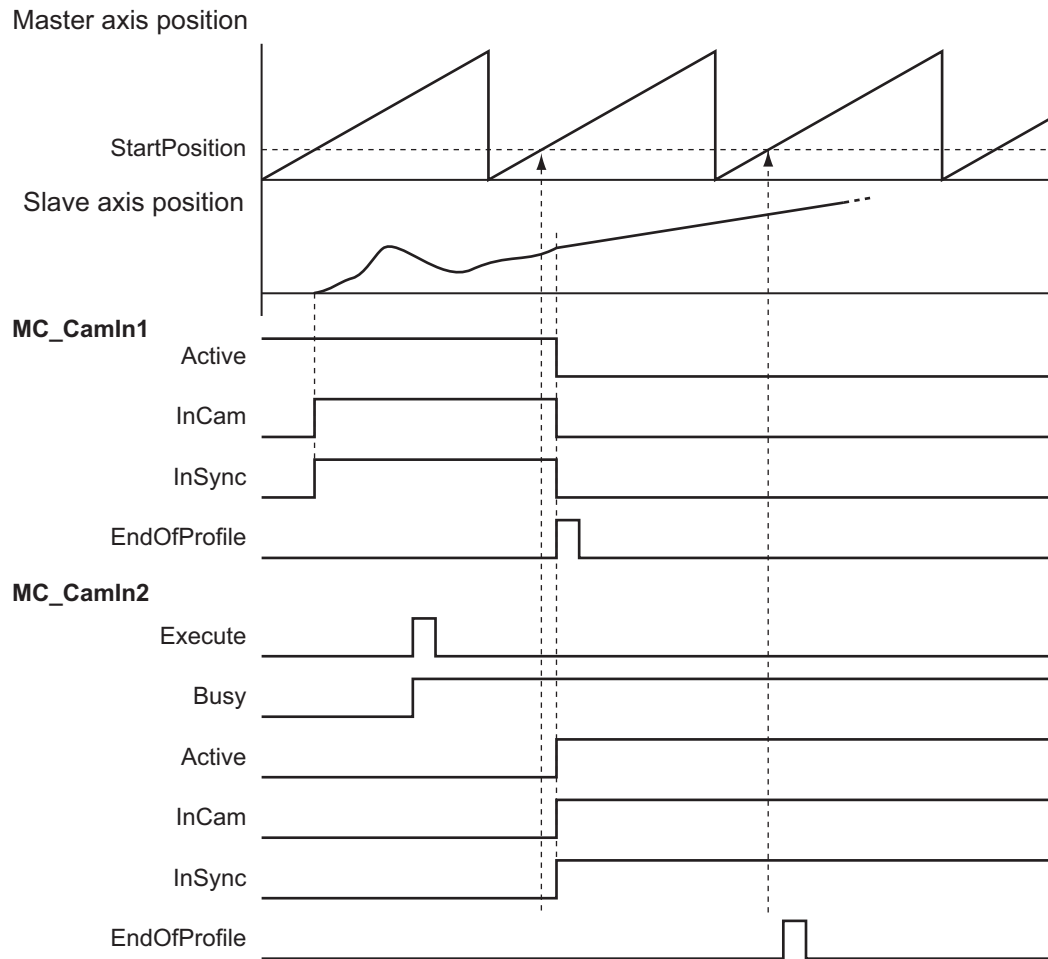

### ● Index

Of the two cam data used to find the command positions of the master and slave axes, the one with the smaller cam data index number is output to the *Index* output variable.

Use this value for fine-tuning the cam data with the Cam Editor or with the user program.

### ● In-position Check

An in-position check is not performed for this instruction.

### ● Override Factors

You cannot set override factors with the MC\_SetOverride (Set Override Factors) instruction for this instruction.

## Timing Charts

### ● Non-periodic Operation

The following timing chart shows the operation when *Periodic* (Periodic Mode) is FALSE (non-periodic) for the MC\_CamIn (Start Cam Operation) instruction.

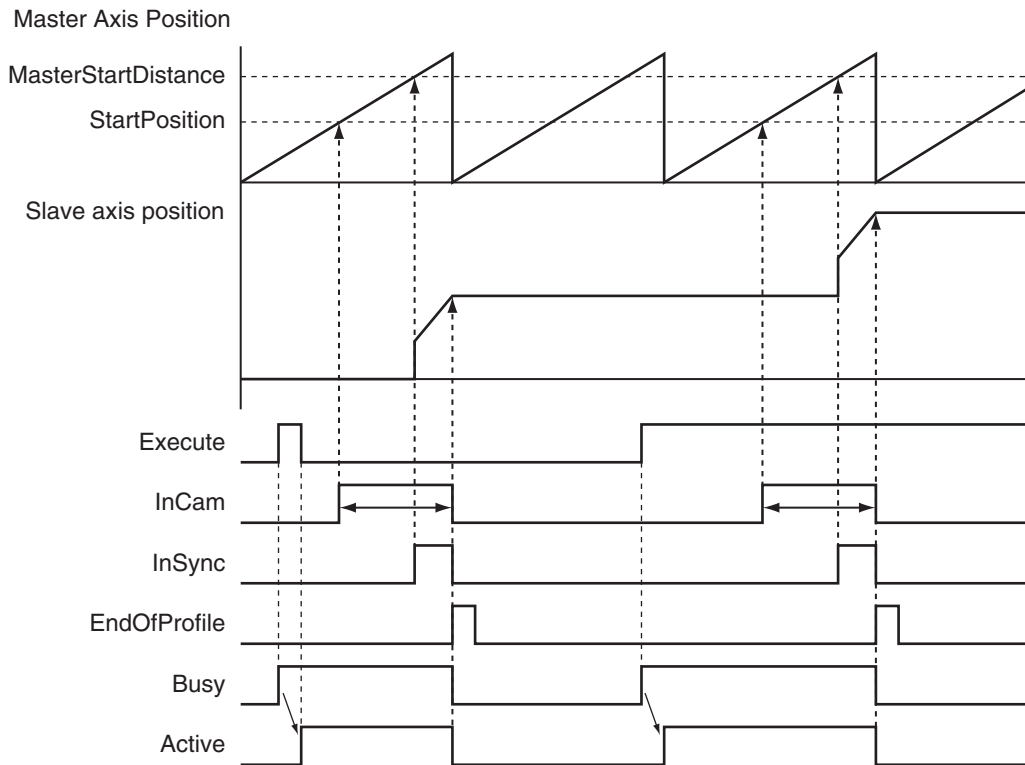

● **Periodic Operation**

The cam motion is repeatedly executed.

The slave axis decelerates to 0 when the cam operation is ended with the MC\_CamOut (End Cam Operation) instruction.

The operation of the master axis is not affected.

The following timing chart shows the operation when *Periodic* (Periodic Mode) is TRUE (periodic) for the MC\_CamIn (Start Cam Operation) instruction and then the MC\_CamOut (End Cam Operation) instruction is executed.

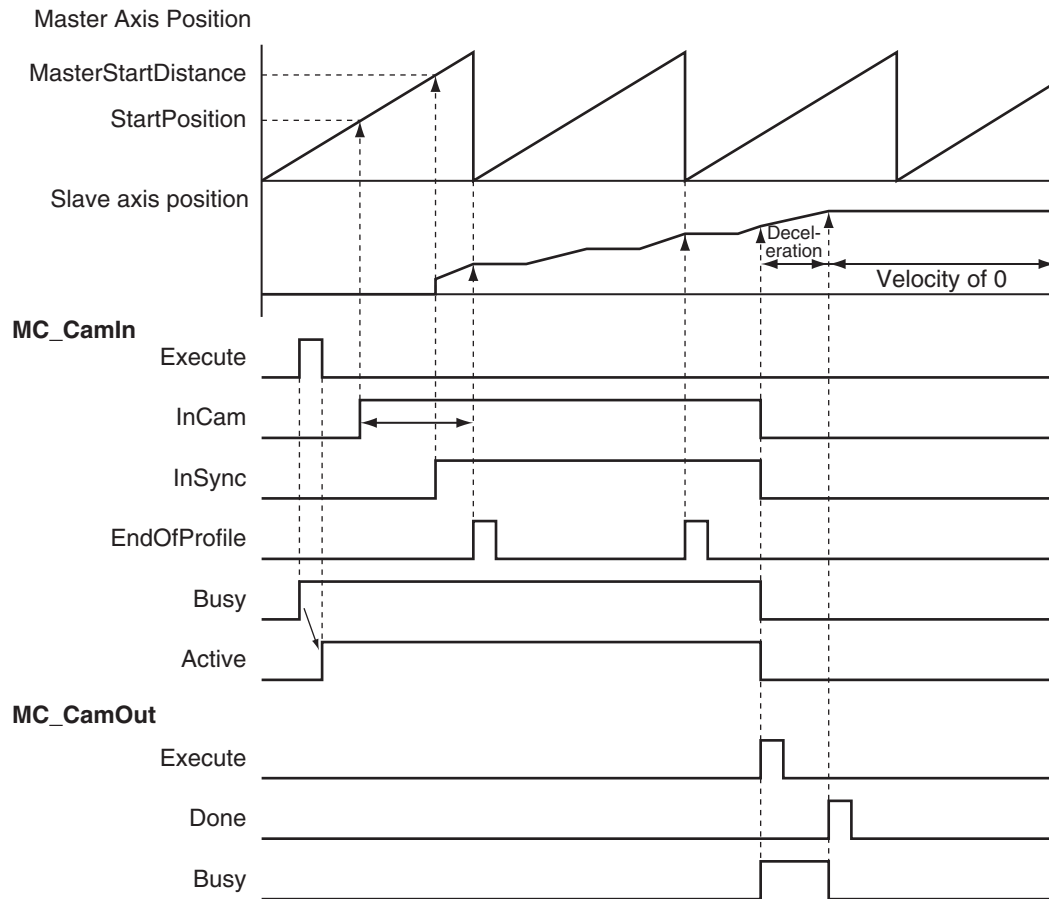

● **MC\_Stop Instruction**

If the MC\_Stop instruction is executed for the master axis during cam operation, the sync between the master axis and slave axis is maintained.

If the MC\_Stop instruction is executed for the slave axis during cam operation, the sync between the master axis and slave axis ends.

The following timing chart displays the operation when *Periodic* (Periodic Mode) is TRUE (periodic) for the MC\_CamIn (Start Cam Operation) instruction and then the MC\_Stop instruction is executed for the slave axis.

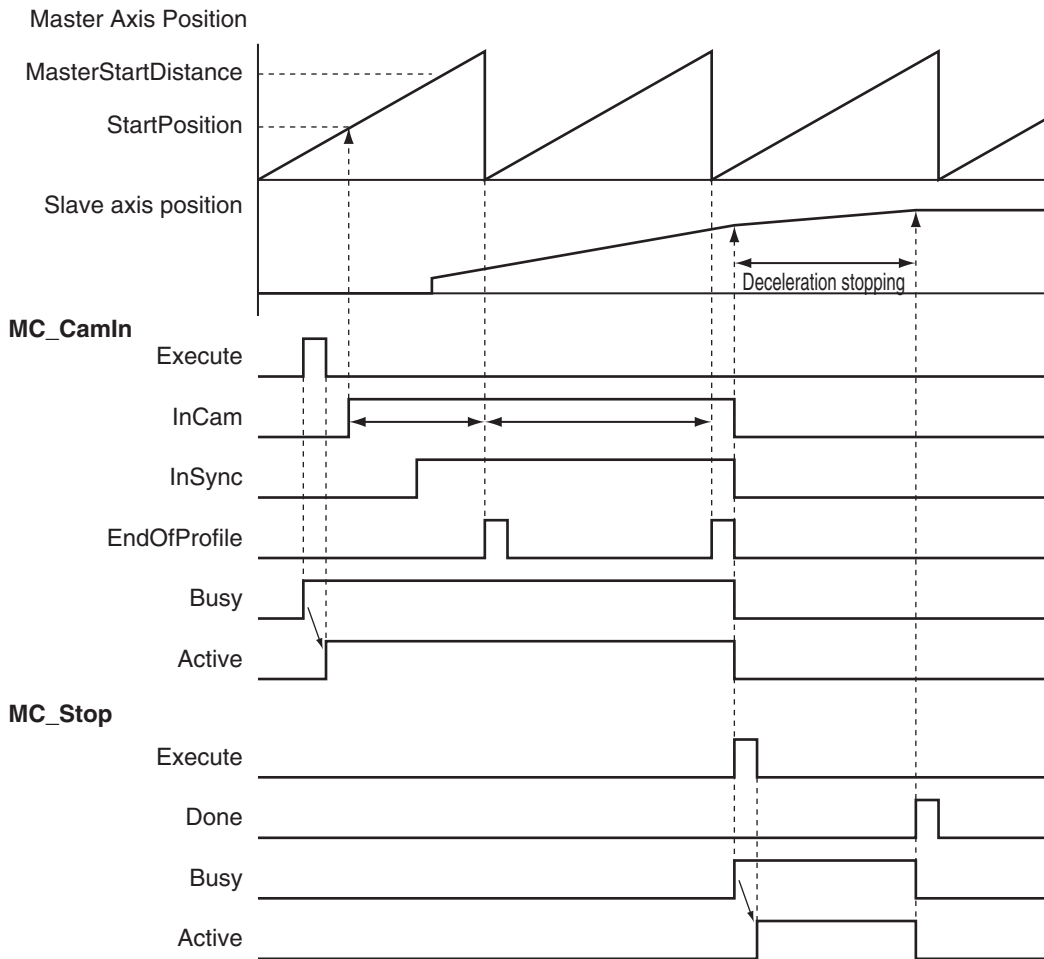

## Aborting the Instruction

If an axis error occurs for the slave axis during execution of this instruction, the slave axis decelerates to a stop at the maximum deceleration rate for the axis. If the MC\_Stop instruction is executed for the slave axis, *CommandAborted* changes to TRUE and the slave axis decelerates to a stop at the deceleration rate that is specified in the MC\_Stop instruction.

Refer to the *NJ/NX-series Troubleshooting Manual (Cat. No. W503)* for information on isolating the causes of axis errors.

If an axis error occurs on the master axis, cam operation will continue.

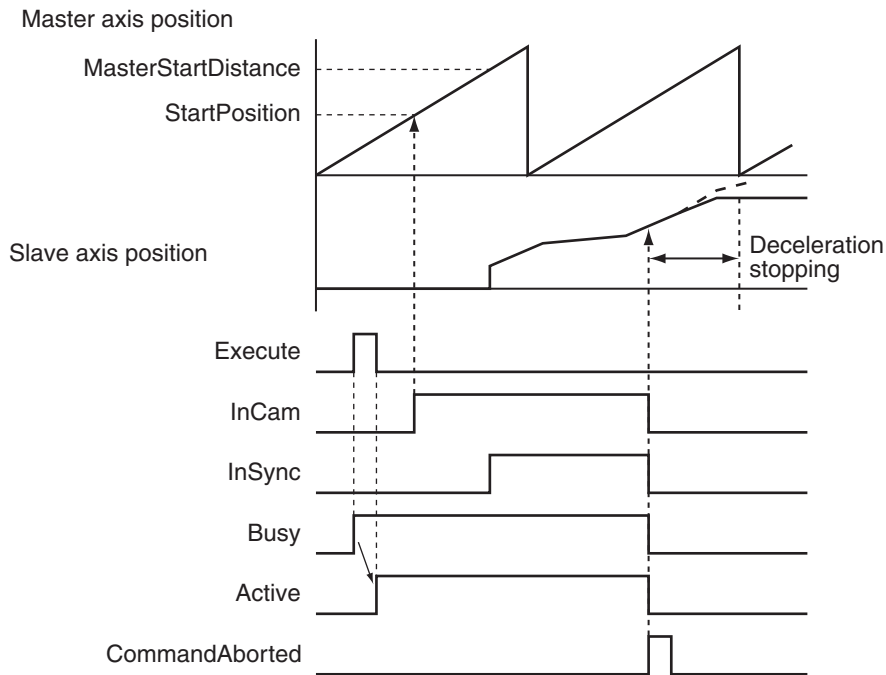

## Re-execution of Motion Control Instructions

You can re-execute this instruction to change the cam table during operation. To change any conditions other than the cam table, use multi-execution of instructions for this instruction.

When re-executing the instruction, *InCam* and *InSync* retain the status that they had prior to the re-execution. If the instruction is re-executed when *InSync* is TRUE, the cam operation starts from the phase that is larger than the phase for the actual position.

The phase for the actual position is found by linearly interpolating between cam data points.

Only the cam table is affected by re-execution.



### Precautions for Correct Use

If a cam table is switched by re-executing the instruction during a cam motion, the velocity or acceleration of the slave axis may change rapidly before or after the cam table is switched. Since this may affect the mechanical machine, be sure to thoroughly verify that there will be no excessive changes in velocity or acceleration before switching the cam table.

For details on re-execution of motion control instructions, refer to the *NJ/NX-series CPU Unit Motion Control User's Manual (Cat. No. W507)*.

### ● Re-execution Procedure

For the procedure to re-execute this instruction, refer to *Sample Programming 1* on page 3-201 and *Sample Programming 2* on page 3-212.

## Multi-execution of Motion Control Instructions

For details on multi-execution of motion control instructions, refer to the *NJ/NX-series CPU Unit Motion Control User's Manual (Cat. No. W507)*.

### ● Execution of Other Instructions during Instruction Execution

Multi-execution of instructions cannot be used for the MC\_GenerateCamTable (Generate Cam Table) instruction during execution of an MC\_CamIn instruction for which the same cam table is specified with *CamTable*.

To use multi-execution of motion instructions for this instruction, specify the slave axis.

When multi-execution of another instruction is performed while this instruction is in execution, the following limits apply depending on the *Buffer Mode*.

- When another instruction is executed by using multi-execution with the Buffer Mode set to **Aborting**, the cam motion is aborted and the next operation is started.
- When another instruction is executed with the Buffer Mode set to **Buffered**, the command position of the next operation is output when *EndOfProfile* (End of Cam Cycle) changes to TRUE.

### ● Multi-execution of MC\_CamIn Instructions with Buffer Mode in Blending

- You can specify **Blending** only for multi-execution of two MC\_CamIn instructions. You cannot execute this instruction with **Blending** during execution of any other instruction.
- Specify the same values for *Master* (Master Axis) and *ReferenceType* (Position Type Selection) as those specified in the instruction that is currently in operation. If you specify different values, a Motion Control Instruction Multi-execution Disabled error will occur.
- The *InSync* output variable from the buffered instruction changes to TRUE in the period in which the current instruction is completed normally, and cam operation starts without the slave axis ever stopping.
- Even if *StartPosition* (Cam Table Start Position) and *MasterStartDistance* (Master Following Distance) are specified, the slave axis starts cam operation as soon as instruction execution starts regardless of the values that are specified. The starting point in the cam table is the final position for the current instruction. The operation is the same regardless of which of the four types of blending is specified.

### ● Execution during Execution of Other Instructions

Multi-execution of instructions cannot be used for this instruction during execution of the MC\_GenerateCamTable (Generate Cam Table) instruction for which the same cam table is specified with *CamTable*.

### ● Master Axis and Slave Axis Compensations

There are the following three instructions that shift the phase of master and slave axes during synchronized control.

Compensations	Instruction
Master axis compensations	MC_Phasing (Shift Master Axis Phase)
Slave axis compensations	MC_SyncOffsetPosition (Cyclic Synchronous Position Offset Compensation) MC_OffsetPosition (Position Offset Compensation)

If multi-execution of instructions causes any synchronized control instruction other than the MC\_CamIn (Start Cam Operation) instruction to be aborted (i.e., if the *CommandAborted* output variable changes to TRUE), any instructions that shift the phase are also aborted as *CommandAborted* changes to TRUE.



If blending is used for multi-execution of two MC\_CamIn (Start Cam Operation) instructions, the instructions that shift the phase are not aborted as *CommandAborted* does not change to TRUE, and processing is continued.

## Errors

If an error occurs during instruction execution, *Error* will change to TRUE.

You can find out the cause of the error by referring to the value output by *ErrorID* (Error Code).

### ● Timing Chart When Error Occurs

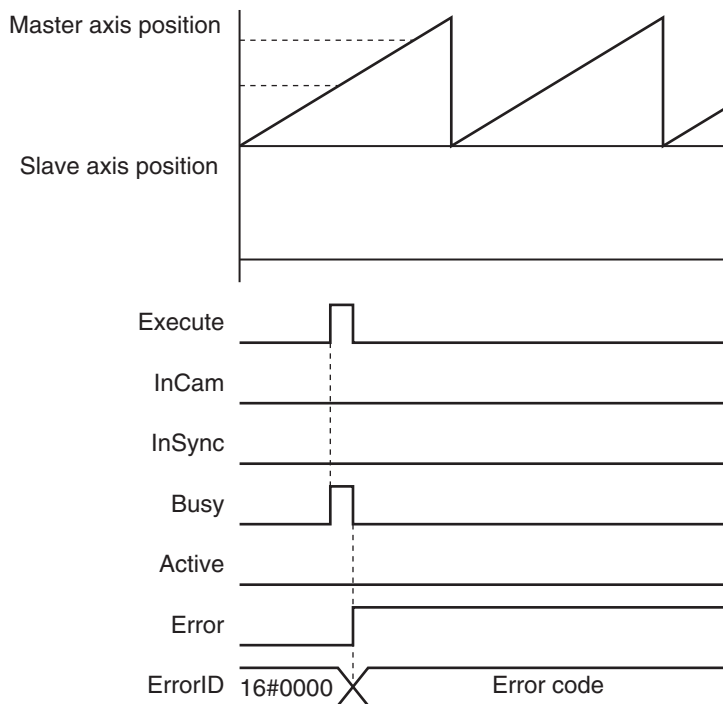

### ● Error Codes

Refer to the *NJ/NX-series Troubleshooting Manual (Cat. No. W503)* for instruction errors.

## Sample Programming 1

This sample programming shows cam operation when periodic operation is specified. In this example, the master axis is axis 1 and the slave axis is axis 2.



### Additional Information

You can specify only the initial values for input variables that are reserved. In this sample, variables with initial values are defined for the instructions, but you do not need to assign variables and parameters when you program them.

## Parameter Settings

The minimum settings required for this sample programming are given below.

● **Setting Axis Parameters**

**Axis Types**

Axis	Axis Type
Axis 1	Servo axis (master axis)
Axis 2	Servo axis (slave axis)

**Count Modes**

Axis	Count Mode
Axis 1	Rotary Mode
Axis 2	Linear Mode

**Ring Counter**

Axis	Modulo maximum position	Modulo minimum position
Axis 1	360	0

**Units of Display**

Axis	Unit of Display
Axis 1	degree
Axis 2	mm

**Operation Example**

● **Operation Pattern**

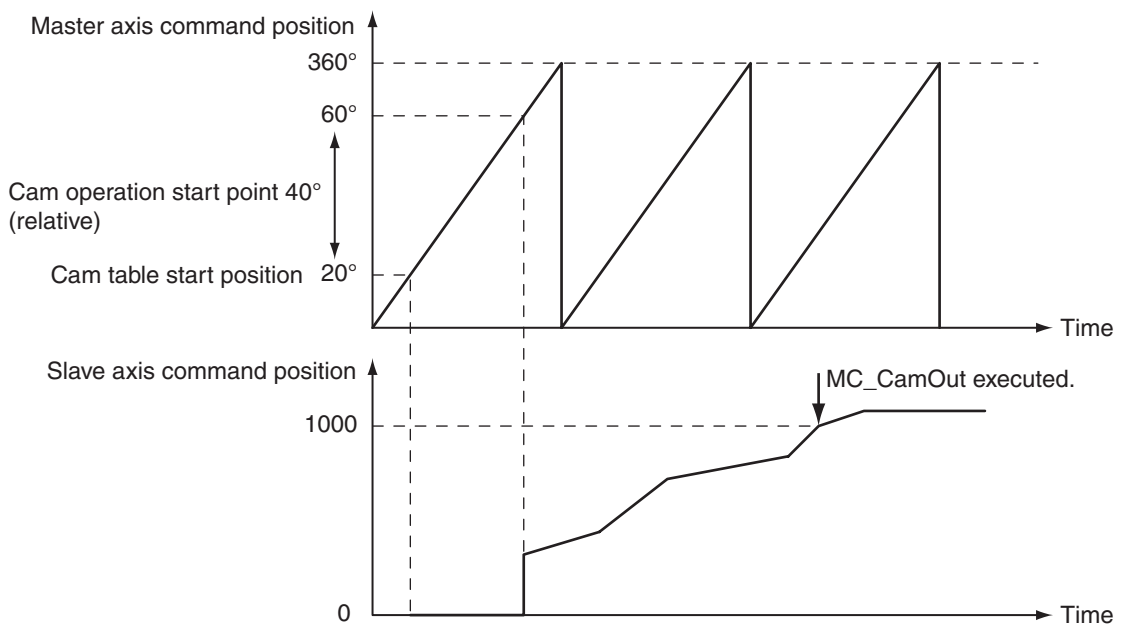

**1** Starting Cam Operation

If the cam table start point position (zero phase position) is 20°, the slave axis starts operation when the master axis reaches a position where the relative angle from that point is 40°. Cam operation operates in a periodic motion.

If *Periodic* is TRUE, periodic operation is performed.

## 2 Ending Cam Operation

When the actual position of the slave axis *MC\_Axis001.Act.Pos* exceeds 1000.0, cam operation is ended and the slave axis is stopped at deceleration rate *DecRate2*.

## Ladder Diagram

### ● Main Variables

Name	Data type	Default	Comment
MC_Axis000	_sAXIS_REF	---	Axis Variable for the master axis, axis 1.
MC_Axis000.MFaultLvl.Active	BOOL	FALSE	TRUE while there is a minor fault level error for axis 1.
MC_Axis000.Details.Homed	BOOL	FALSE	TRUE when home is defined for axis 1.
MC_Axis001	_sAXIS_REF	---	Axis Variable for the slave axis, axis 2.
MC_Axis001.MFaultLvl.Active	BOOL	FALSE	TRUE while there is a minor fault level error for axis 2.
MC_Axis001.Details.Homed	BOOL	FALSE	TRUE when home is defined for axis 2.
Pwr1_S	BOOL	FALSE	This variable is assigned to the <i>Status</i> output variable from the PWR1 instance of the MC_Power instruction. This variable changes to TRUE when the Servo is turned ON.
Pwr2_S	BOOL	FALSE	This variable is assigned to the <i>Status</i> output variable from the PWR2 instance of the MC_Power instruction. This variable changes to TRUE when the Servo is turned ON.
CamProfile0	ARRAY[0..360] OF _sMC_CAM_REF	---	This is the cam data variable. The array elements ARRAY[0..N] are set with the Cam Editor. In this sample, 0 to 360 are used, but the number of array elements depends on the settings that you make with the Cam Editor.
DecRate2	LREAL	10000.0	This variable sets the deceleration rate for execution of MC_CamOut.
Vel_InVel	BOOL	FALSE	This variable is assigned to the <i>InVelocity</i> output variable from the VEL instance of the MC_MoveVelocity instruction. It is TRUE when the target velocity is reached.
Camin_InCam0	BOOL	FALSE	This variable is assigned to the <i>InCam</i> output variable from the CAMIN instance of the MC_CamIn instruction. It is TRUE during cam operation.
Camout_Ex	BOOL	FALSE	The CAMOUT instance of MC_CamOut is executed while this variable is TRUE.

Name	Data type	Default	Comment
StartPg	BOOL	FALSE	The Servo is turned ON if this variable is TRUE and EtherCAT process data communications are established.

## ● Timing Chart

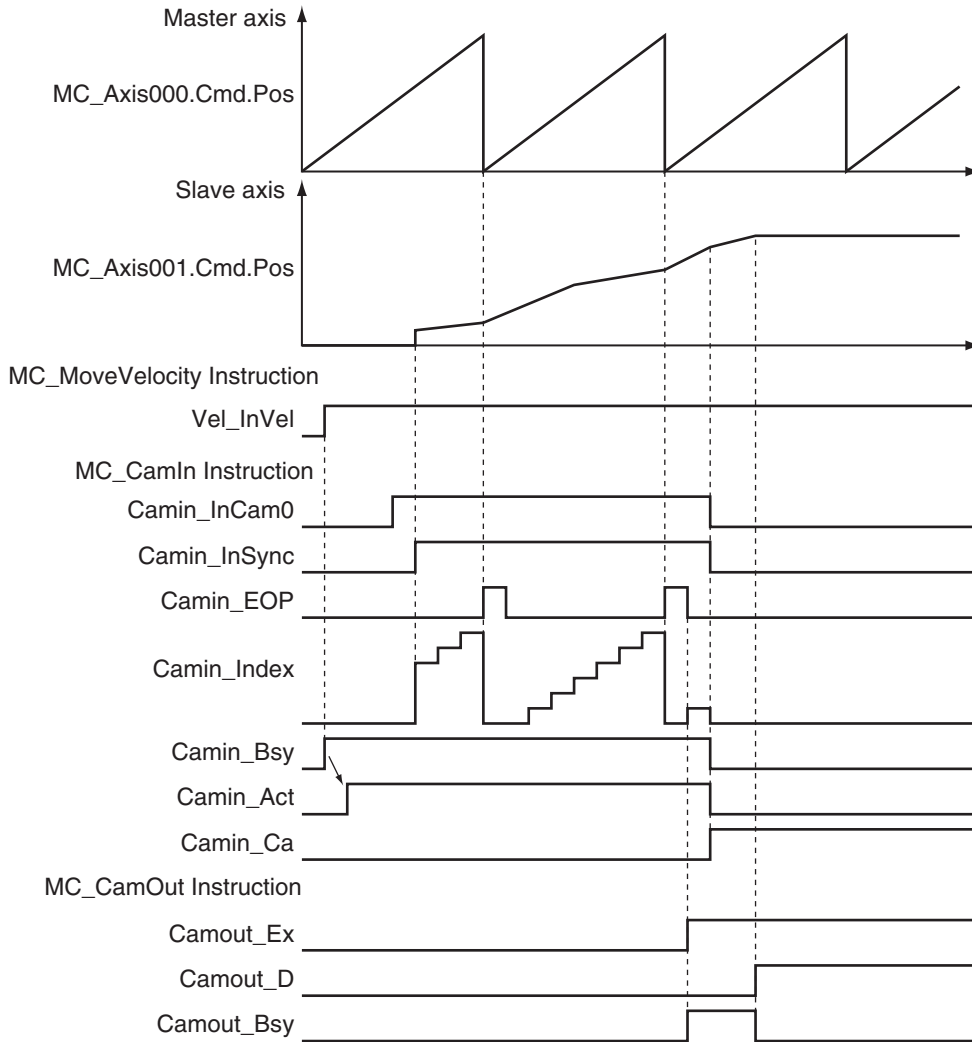

## ● Sample Programming

If *StartPg* is TRUE, check that the Servo Drive for axis 1 is ready.



If *StartPg* is TRUE, check that the Servo Drive for axis 2 is ready.

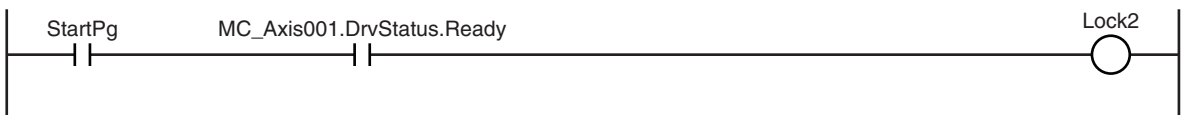

If the Servo Drive for axis 1 is ready, the Servo is turned ON.

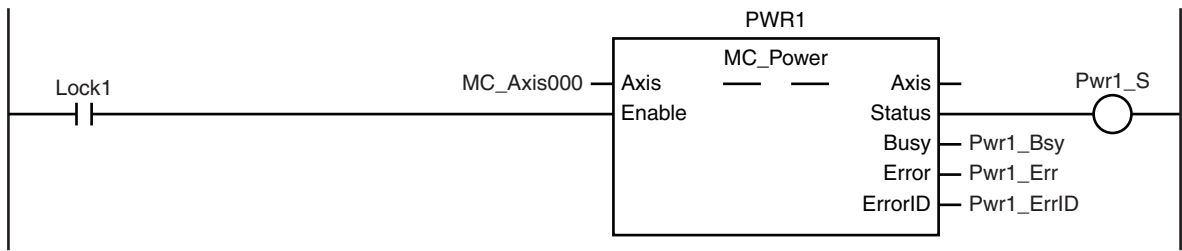

If the Servo Drive for axis 2 is ready, the Servo is turned ON.

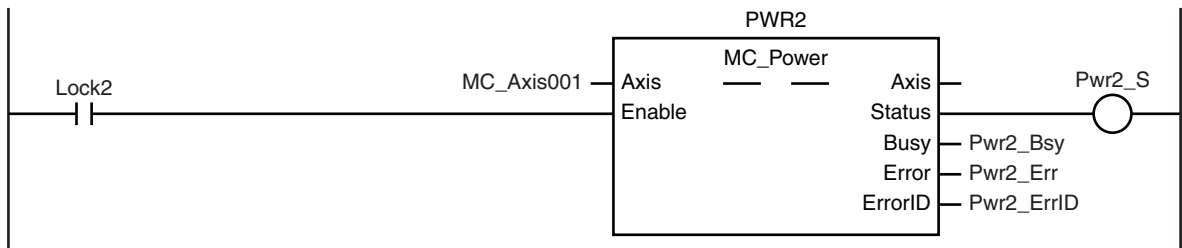

If a minor fault level error occurs for the axis composition, the error handler for the device (FaultHandler) is executed.  
Program the FaultHandler according to the device.

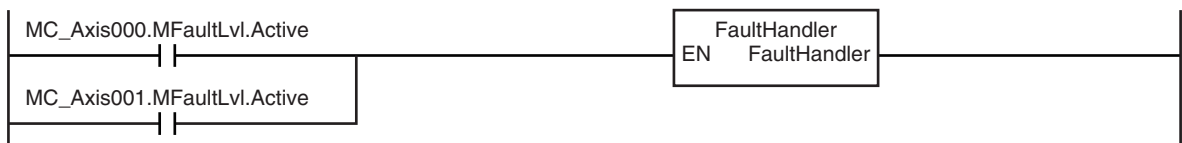

If the Servo is ON for axis 1 and home is not defined, the Home instruction is executed to define home.

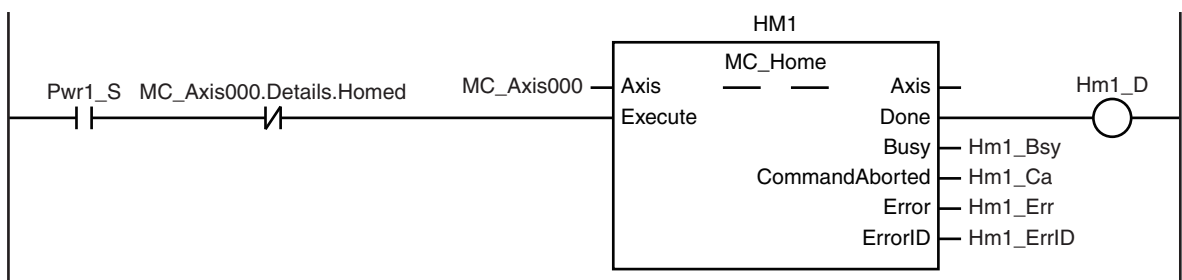

If the Servo is ON for axis 2 and home is not defined, the Home instruction is executed to define home.

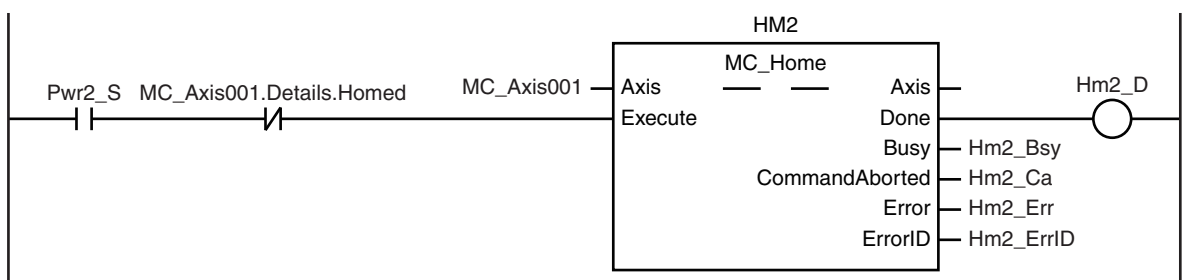

The MC\_MoveVelocity (Velocity Control) instruction is executed after homing is completed for axis 1.

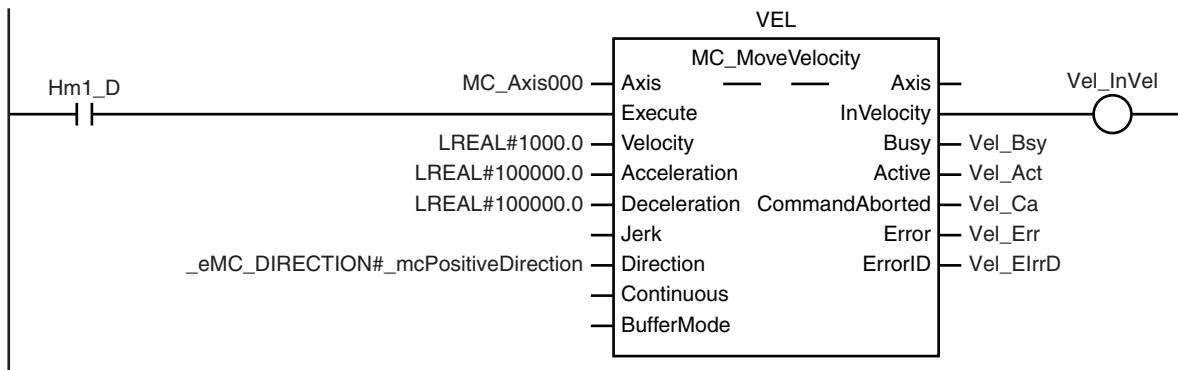

The MC\_CamIn (Start Cam Operation) instruction is executed if *Vel\_InVel* is TRUE for the MC\_MoveVelocity (Velocity Control) instruction.

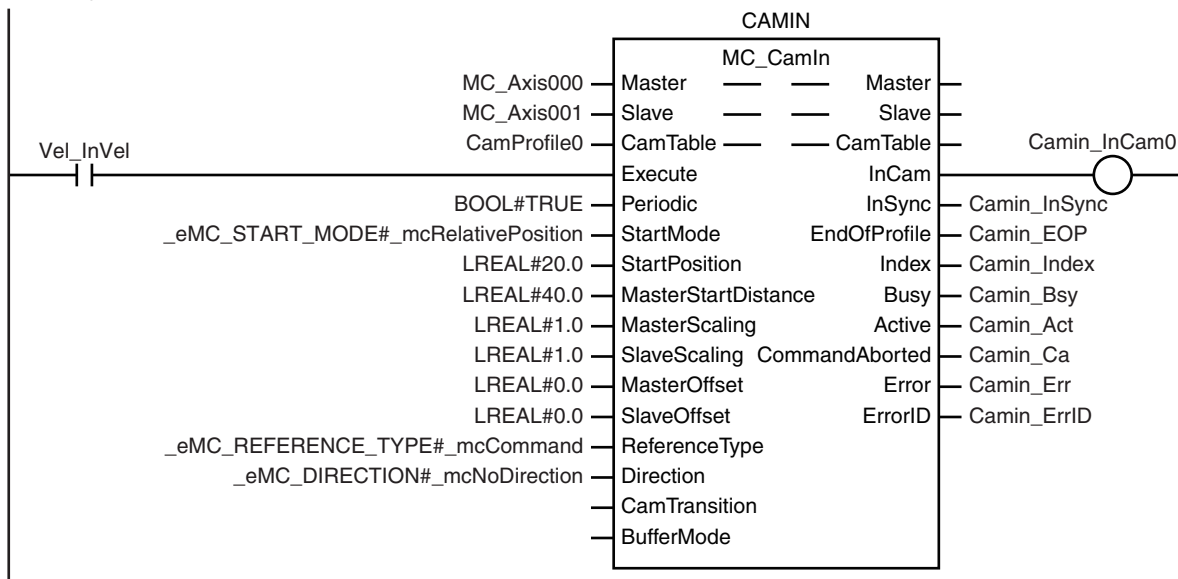

*CamOut\_Ex* changes to TRUE if *Camin\_InCam0* is TRUE and *MC\_Axis001.Act.Pos* exceeds 1000.

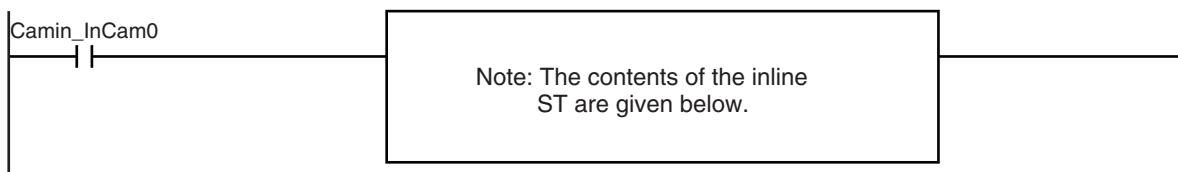

The MC\_CamOut (End Cam Operation) instruction is executed when *Camout\_Ex* changes to TRUE. The deceleration rate is specified by *DecRate2*.

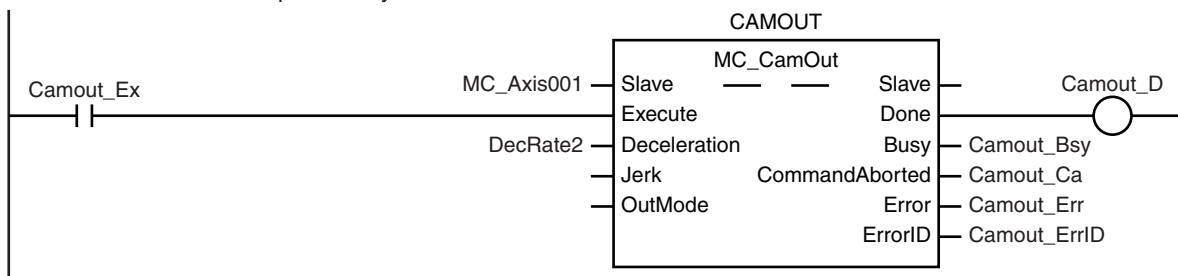

### Contents of Inline ST

```

IF MC_Axis001.Act.Pos>LREAL#1000.0 THEN
    Camout_Ex := TRUE;
END_IF;

```

## Structured Text (ST)

### ● Main Variables

Name	Data type	Default	Comment
MC_Axis000	_sAXIS_REF	---	Axis Variable for the master axis, axis 1.
MC_Axis000.MFaultLvl.Active	BOOL	FALSE	TRUE while there is a minor fault level error for axis 1.
MC_Axis000.Details.Homed	BOOL	FALSE	TRUE when home is defined for axis 1.
MC_Axis001	_sAXIS_REF	---	Axis Variable for the slave axis, axis 2.
MC_Axis001.MFaultLvl.Active	BOOL	FALSE	TRUE while there is a minor fault level error for axis 2.
MC_Axis001.Details.Homed	BOOL	FALSE	TRUE when home is defined for axis 2.
Pwr1_S	BOOL	FALSE	This variable is assigned to the <i>Status</i> output variable from the PWR1 instance of the MC_Power instruction. This variable changes to TRUE when the Servo is turned ON.
Pwr2_S	BOOL	FALSE	This variable is assigned to the <i>Status</i> output variable from the PWR2 instance of the MC_Power instruction. This variable changes to TRUE when the Servo is turned ON.
CamProfile0	ARRAY[0..360] OF _sMC_CAM_REF	---	This is the cam data variable. The array elements ARRAY[0..N] are set with the Cam Editor. In this sample, 0 to 360 are used, but the number of array elements depends on the settings that you make with the Cam Editor.
DecRate2	LREAL	10000.0	This variable sets the deceleration rate for execution of MC_CamOut.
Vel_InVel	BOOL	FALSE	This variable is assigned to the <i>InVelocity</i> output variable from the VEL instance of the MC_MoveVelocity instruction. It is TRUE when the target velocity is reached.
Camin_InCam0	BOOL	FALSE	This variable is assigned to the <i>InCam</i> output variable from the CAMIN instance of the MC_CamIn instruction. It is TRUE during cam operation.
Camout_Ex	BOOL	FALSE	The CAMOUT instance of MC_CamOut is executed while this variable is TRUE.
StartPg	BOOL	FALSE	The Servo is turned ON if this variable is TRUE and EtherCAT process data communications are established.

Name	Data type	Default	Comment
Camin_Ex	BOOL	FALSE	This variable is changed to TRUE when Vel_InVel changes to TRUE to change <i>Execute</i> for the CAMIN instance of MC_CamIn to TRUE.
InitFlag	BOOL	FALSE	This variable indicates if it is necessary to set the input parameters. Input parameters are set when this variable is FALSE. When setting the input parameters is completed, this variable changes to TRUE.

#### ● Timing Chart

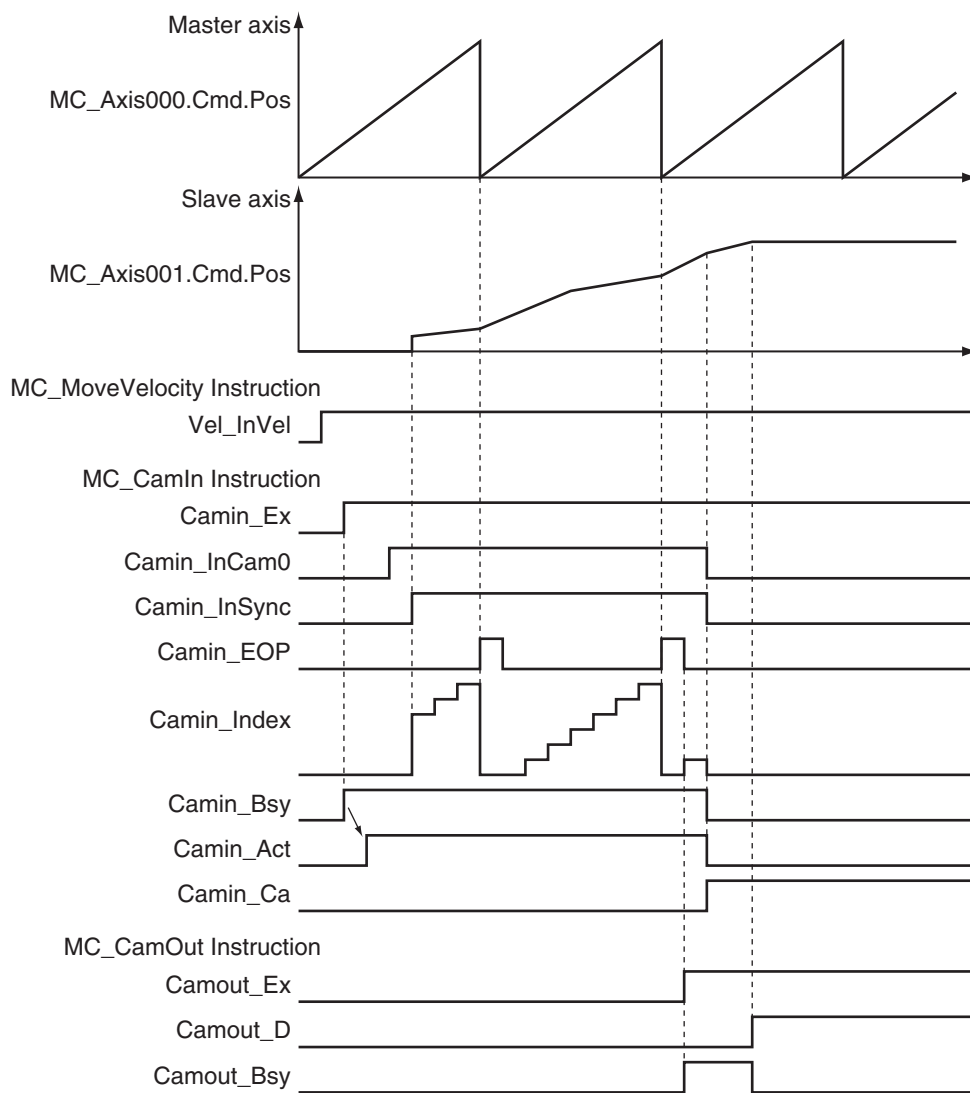

#### ● Sample Programming

```
// Processing when input parameters are not set
IF InitFlag=FALSE THEN

    // MC_CamIn parameters
```



```

Camin_EM := TRUE; // Periodic Mode
Camin_StMode := _eMC_START_MODE#_mcRelativePosition;
Camin_StPos := LREAL#20.0; // Master axis absolute position for start point
Camin_MStDis := LREAL#40.0; // Master axis position to start cam operation
Camin_MSc := LREAL#1.0; // Master axis scaling
Camin_SSc := LREAL#1.0; // Slave axis scaling
Camin_MO := LREAL#0.0; // Master offset
Camin_SO := LREAL#0.0; // Slave offset
Camin_RT := _eMC_REFERENCE_TYPE#_mcCommand;// Position type selection
Camin_Dir := _eMC_DIRECTION#_mcNoDirection;// Direction

// MC_MoveVelocity parameters
Vel_Vel := LREAL#1000.0;
Vel_Acc := LREAL#100000.0;
Vel_Dec := LREAL#100000.0;
Vel_Dir := _eMC_DIRECTION#_mcPositiveDirection;

// MC_CamOut parameters
Camout_Dec := DecRate2;

// Change InitFlag to TRUE after setting the input parameters.
InitFlag := TRUE;

END_IF;

// If StartPg is TRUE and the Servo Drive is ready, the Servo for axis 1 is turned
ON.
// If the Servo Drive is not ready, the Servo is turned OFF.
IF (StartPg=TRUE)
  AND (MC_Axis000.DrvStatus.Ready=TRUE) THEN
    Pwr1_En:=TRUE;
  ELSE
    Pwr1_En:=FALSE;
  END_IF;

// If StartPg is TRUE and the Servo Drive is ready, the Servo for axis 2 is turned
ON.
// If the Servo Drive is not ready, the Servo is turned OFF.
IF (StartPg=TRUE)
  AND (MC_Axis001.DrvStatus.Ready=TRUE) THEN
    Pwr2_En:=TRUE;
  ELSE
    Pwr2_En:=FALSE;
  END_IF;

// If a minor fault level error occurs for axis 1 or axis 2, the error handler for
the device is executed.

```

```
// Program the FaultHandler according to the device.
IF (MC_Axis000.MFaultLvl.Active=TRUE)
  OR (MC_Axis001.MFaultLvl.Active=TRUE) THEN
  FaultHandler();
END_IF;

// If the Servo is ON for axis 1 and home is not defined, the Home instruction is e
xecuted for axis 1.
IF (Pwr1_S=TRUE)
  AND (MC_Axis000.Details.Homed=FALSE) THEN
  Hm1_Ex:=TRUE;
END_IF;

// If the Servo is ON for axis 2 and home is not defined, the Home instruction is e
xecuted for axis 2.
IF (Pwr2_S=TRUE)
  AND (MC_Axis001.Details.Homed=FALSE) THEN
  Hm2_Ex:=TRUE;
END_IF;

// After homing is completed for axis 1, MC_MoveVelocity is executed.
IF Hm1_D=TRUE THEN
  Vel_Ex := TRUE;
END_IF;

// CamIn is executed when InVel of MC_MoveVelocity is TRUE.
IF Vel_InVel=TRUE THEN
  Camin_Ex := TRUE;
END_IF;

// CamOut is executed when Camin_InCam0 is TRUE and MC_Axis001.Act.Pos is greater t
han 1000.
IF (Camin_InCam0=TRUE)
  AND (MC_Axis001.Act.Pos>LREAL#1000.0) THEN
  Camout_Ex := TRUE;
END_IF;

// MC_Power for axis 1
PWR1(
  Axis := MC_Axis000,
  Enable := Pwr1_En,
  Status => Pwr1_S,
  Busy => Pwr1_Bsy,
  Error => Pwr1_Err,
  ErrorID => Pwr1_ErrID
);
```

```

// MC_Power for axis 2
PWR2 (
    Axis := MC_Axis001,
    Enable := Pwr2_En,
    Status => Pwr2_S,
    Busy => Pwr2_Bsy,
    Error => Pwr2_Err,
    ErrorID => Pwr2_ErrID
);

// MC_Home for axis 1
HM1 (
    Axis := MC_Axis000,
    Execute := Hm1_Ex,
    Done => Hm1_D,
    Busy => Hm1_Bsy,
    CommandAborted => Hm1_Ca,
    Error => Hm1_Err,
    ErrorID => Hm1_ErrID
);

// MC_Home for axis 2
HM2 (
    Axis := MC_Axis001,
    Execute := Hm2_Ex,
    Done => Hm2_D,
    Busy => Hm2_Bsy,
    CommandAborted => Hm2_Ca,
    Error => Hm2_Err,
    ErrorID => Hm2_ErrID
);

// MC_MoveVelocity
VEL (
    Axis := MC_Axis000,
    Execute := Vel_Ex,
    Velocity := Vel_Vel,
    Acceleration := Vel_Acc,
    Deceleration := Vel_Dec,
    Direction := Vel_Dir,
    InVelocity => Vel_InVel,
    Busy => Vel_Bsy,
    Active => Vel_Act,
    CommandAborted => Vel_Ca,
    Error => Vel_Err,
    ErrorID => Vel_ErrID
);

```

```
// MC_CamIn
CAMIN(
    Master := MC_Axis000,
    Slave := MC_Axis001,
    CamTable := CamProfile0,
    Execute := Camin_Ex,
    Periodic := Camin_EM,
    StartMode := Camin_StMode,
    StartPosition := Camin_StPos,
    MasterStartDistance := Camin_MStDis,
    MasterScaling := Camin_MSc,
    SlaveScaling := Camin_SSc,
    MasterOffset := Camin_MO,
    SlaveOffset := Camin_SO,
    ReferenceType := Camin_RT,
    Direction := Camin_Dir,
    CamTransition := Camin_CT,
    BufferMode := Camin_BM,
    InCam => Camin_InCam0,
    InSync => Camin_InSync,
    EndOfProfile => Camin_EOP,
    Index => Camin_Index,
    Busy => Camin_Bsy,
    Active => Camin_Act,
    CommandAborted => Camin_Ca,
    Error => Camin_Err,
    ErrorID => Camin_ErrID
);

// MC_CamOut
CAMOUT(
    Slave := MC_Axis001,
    Execute := Camout_Ex,
    Deceleration := Camout_Dec,
    Done => Camout_D,
    Busy => Camout_Bsy,
    CommandAborted => Camout_Ca,
    Error => Camout_Err,
    ErrorID => Camout_ErrID
);
```

### Sample Programming 2

This sample programming shows cam operation for a liquid filler.

**Additional Information**

You can specify only the initial values for input variables that are reserved. Parameters are not specified in this sample.

**Parameter Settings**

The minimum settings required for this sample programming are given below.

- **Setting Axis Parameters**

**Axis Types**

Axis	Axis Type
Axis 1	Servo axis (master axis)
Axis 2	Servo axis (slave axis)
Axis 3	Servo axis (slave axis)
Axis 4	Servo axis (slave axis)
Axis 5	Servo axis (slave axis)

**Count Modes**

Axis	Count Mode
Axis 1	Rotary Mode
Axis 2	Rotary Mode
Axis 3	Rotary Mode
Axis 4	Rotary Mode
Axis 5	Rotary Mode

**Ring Counters**

Axis	Modulo maximum position	Modulo minimum position
Axis 1	360	0
Axis 2	360	0
Axis 3	360	0
Axis 4	360	0
Axis 5	360	0

**Units of Display**

Axis	Unit of Display
Axis 1	degree
Axis 2	degree
Axis 3	degree
Axis 4	degree
Axis 5	degree

## Operation Example

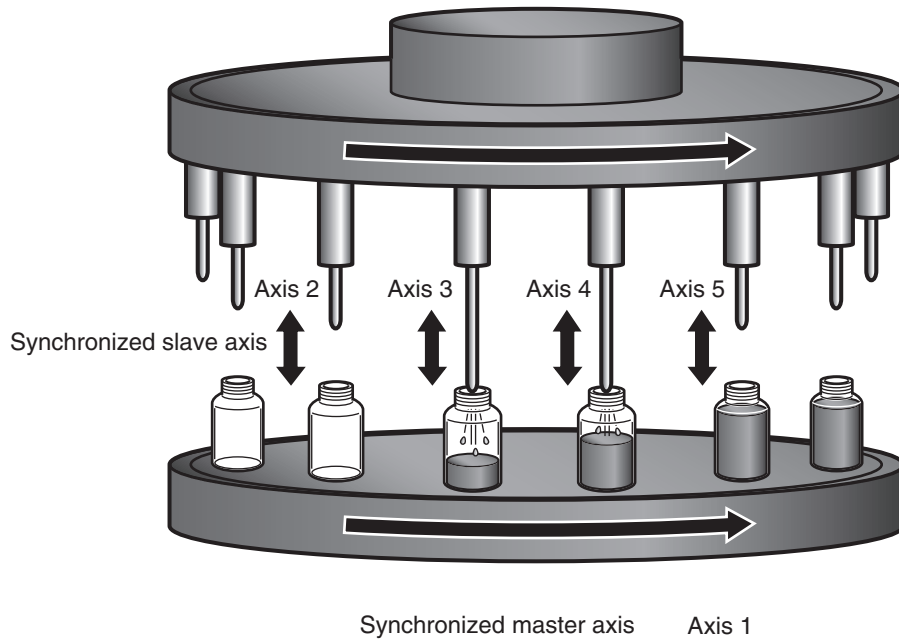

### ● Operation Pattern

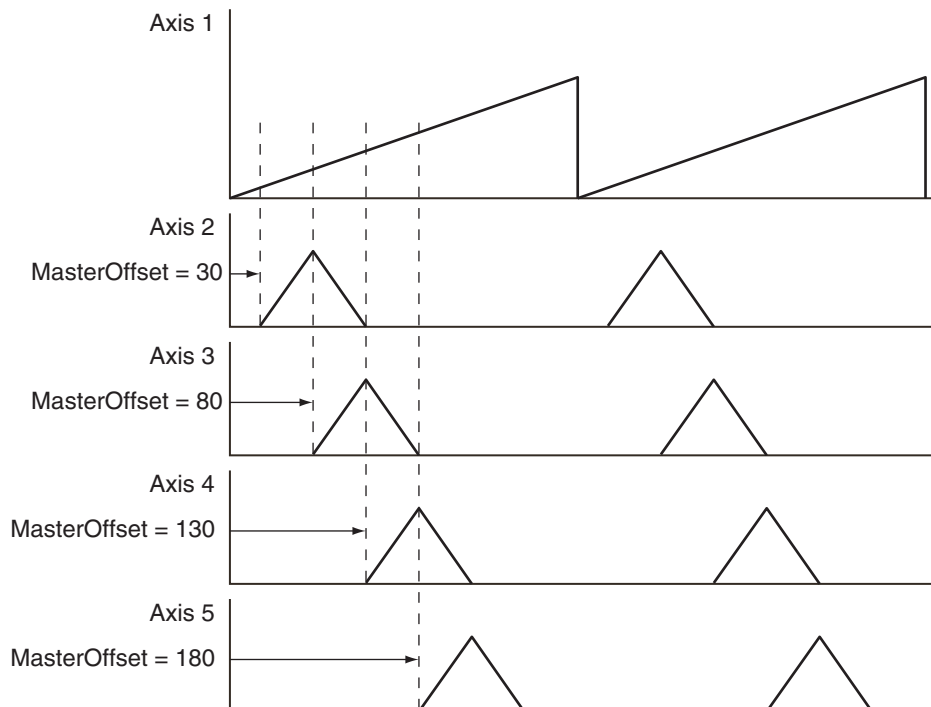

#### 1 Start Cam Operation

The slave axes, axes 2 to 5, perform cam operation in synchronization with the master axis, axis 1. Each axis shifts its phase by  $50^\circ$  and starts cam operation.

#### 2 Periodic Operation

Each axis periodically executes the specified cam operation.

## Ladder Diagram

### ● Main Variables

Name	Data type	Default	Comment
MC_Axis000	_sAXIS_REF	---	Axis Variable for the master axis, axis 1.
MC_Axis001	_sAXIS_REF	---	Axis Variable for the slave axis, axis 2.
MC_Axis002	_sAXIS_REF	---	Axis Variable for the slave axis, axis 3.
MC_Axis003	_sAXIS_REF	---	Axis Variable for the slave axis, axis 4.
MC_Axis004	_sAXIS_REF	---	Axis Variable for the slave axis, axis 5.
StartPg	BOOL	FALSE	The Servo is turned ON if this variable is TRUE and EtherCAT process data communications are established.
Vel_InVel	BOOL	FALSE	This variable is assigned to the <i>InVelocity</i> output variable from the VEL instance of the MC_MoveVelocity instruction. It is TRUE when the target velocity is reached.
CamProfile0	ARRAY[0..360] OF _sMC_CAM_REF	---	This is the cam data variable. This variable is assigned to the <i>CamTable</i> input variables from the CAMIN1 to CAMIN4 instances of the MC_CamIn instruction. The array elements ARRAY[0..N] are set with the Cam Editor.

● **Timing Chart**

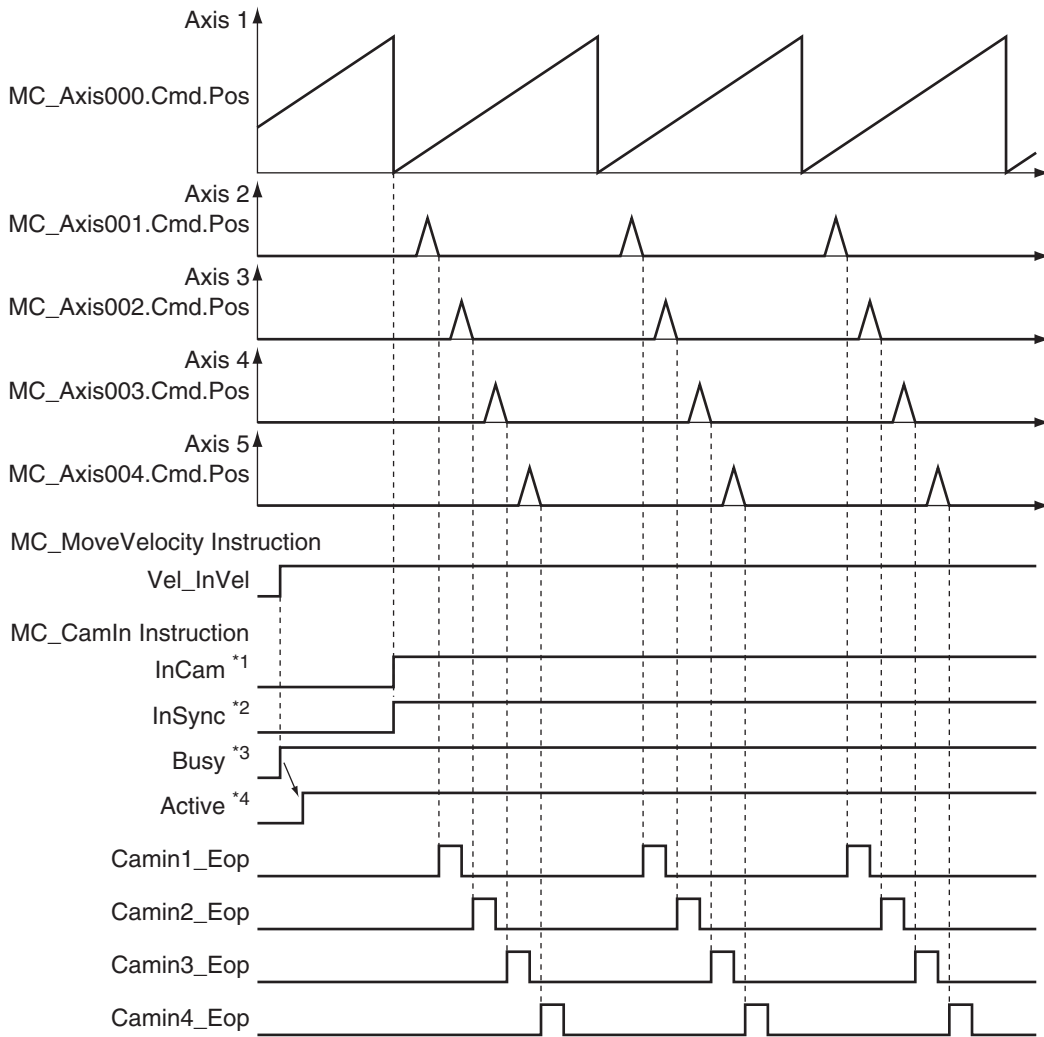

- \*1. The timing is the same for the following: Camin1\_InCam, Camin2\_InCam, Camin3\_InCam, and Camin4\_InCam.
- \*2. The timing is the same for the following: Camin1\_InSync, Camin2\_InSync, Camin3\_InSync, and Camin4\_InSync.  
In this sample, *MasterStartDistance* is 0, so *InSync* changes to TRUE from when the master axis is 0°.
- \*3. The timing is the same for the following: Camin1\_Bsy, Camin2\_Bsy, Camin3\_Bsy, and Camin4\_Bsy.
- \*4. The timing is the same for the following: Camin1\_Act, Camin2\_Act, Camin3\_Act, and Camin4\_Act.

● **Sample Programming**

If *StartPg* is TRUE, check that the Servo Drives for each axis are ready.

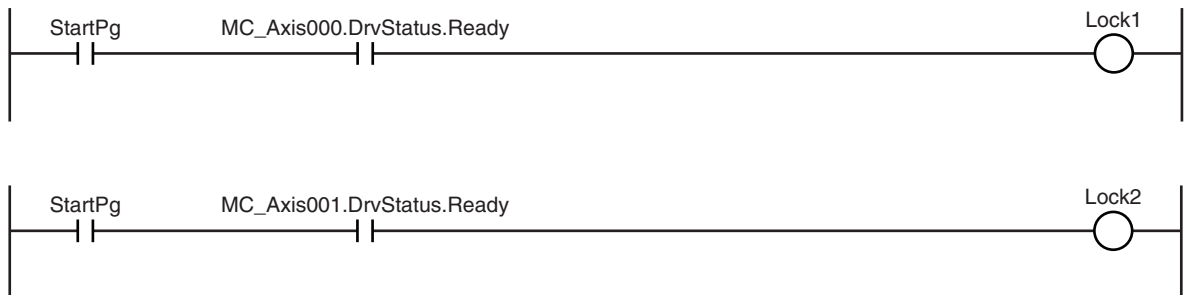



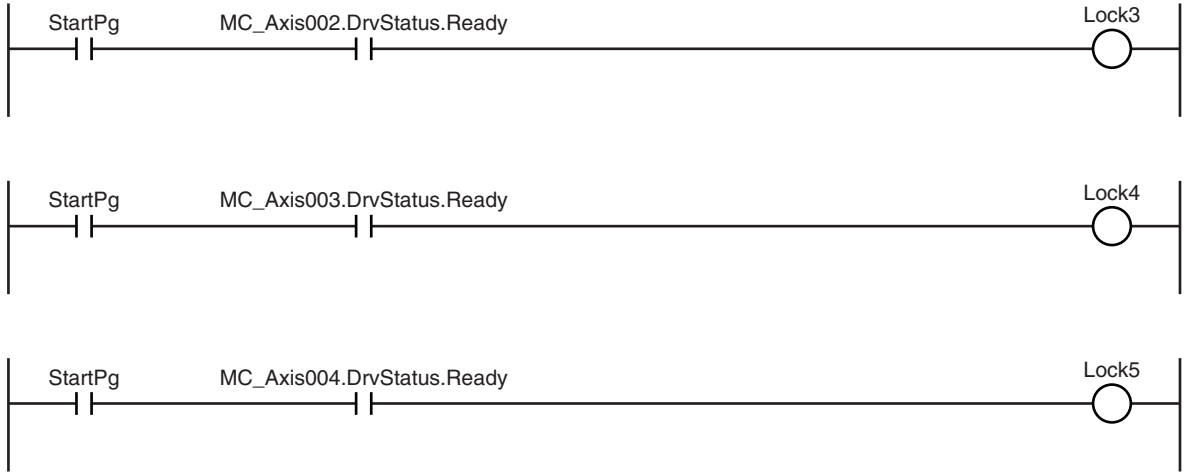

If the Servo Drives are ready, the Servos are turned ON for each axis.

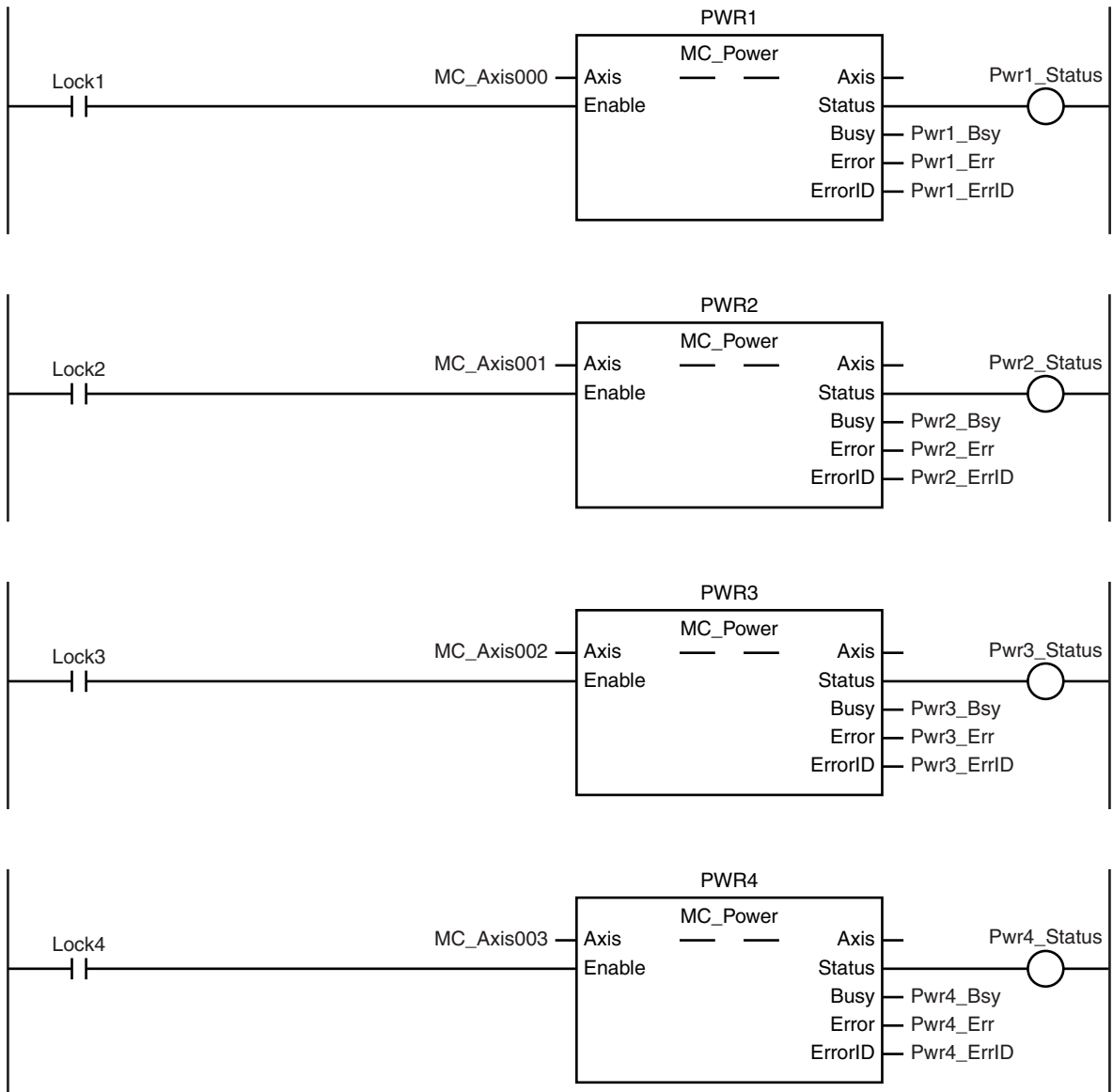

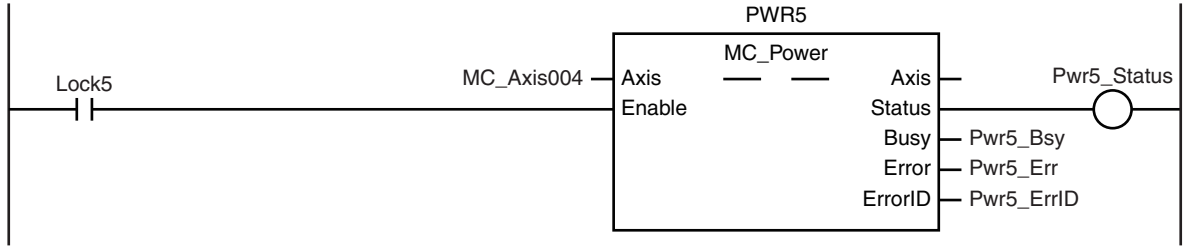

If a minor fault level error occurs for the axis composition, the error handler for the device (FaultHandler) is executed.

Program the FaultHandler according to the device.

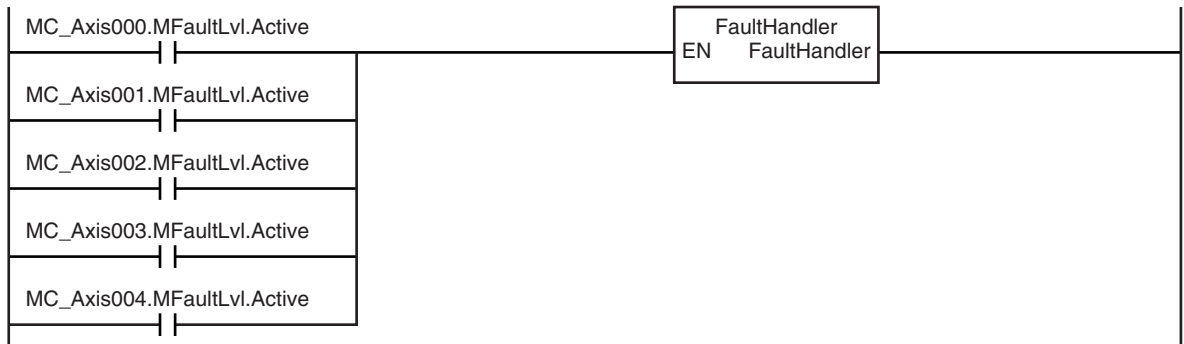

If the Servo is ON for axis 1 to axis 5 and the Home instruction is executed for each axis if home is not defined.

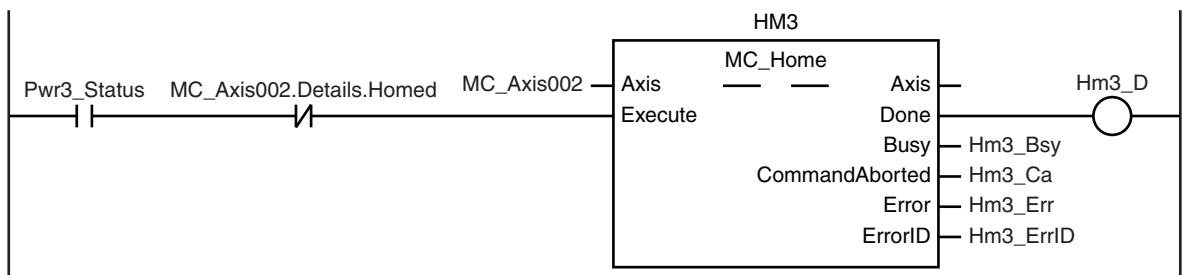
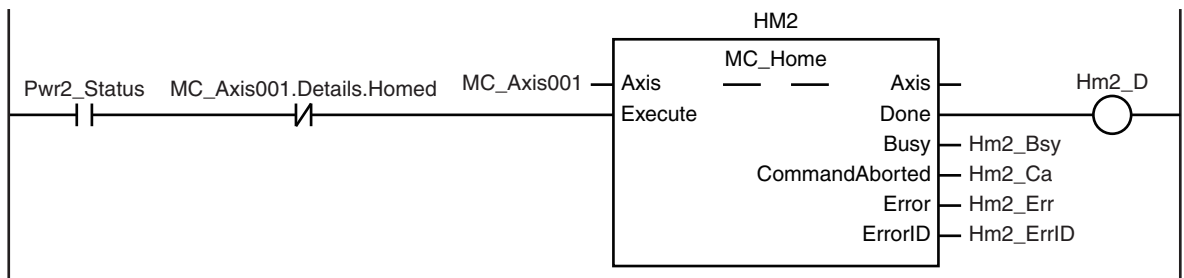
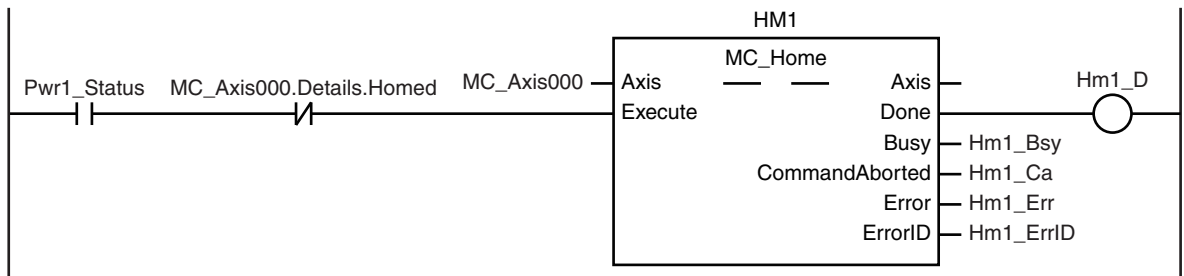

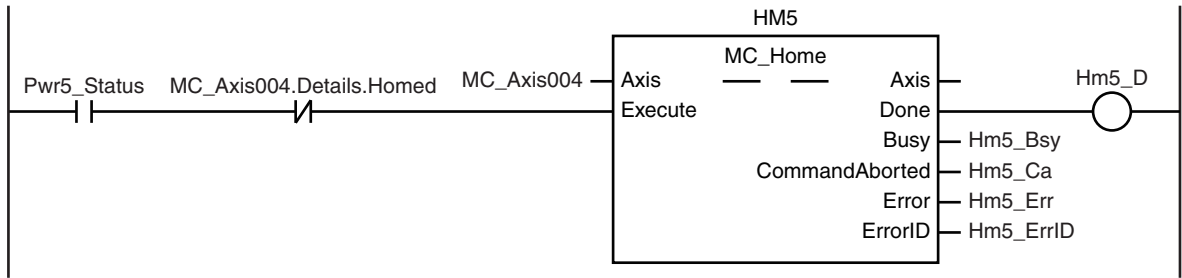
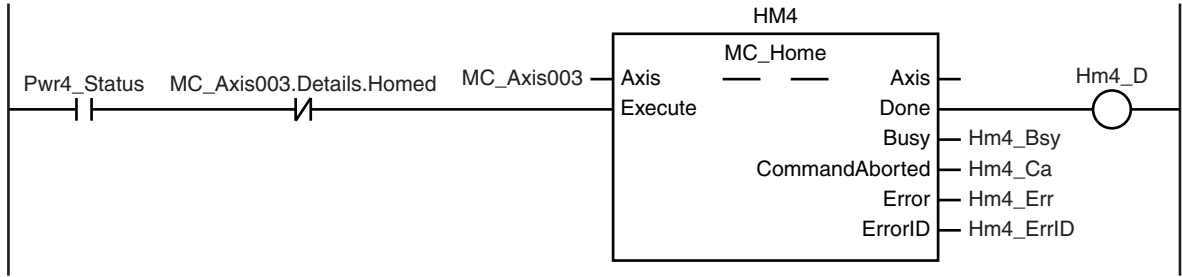

The MC\_MoveVelocity (Velocity Control) instruction is executed after homing is completed for axis 1.

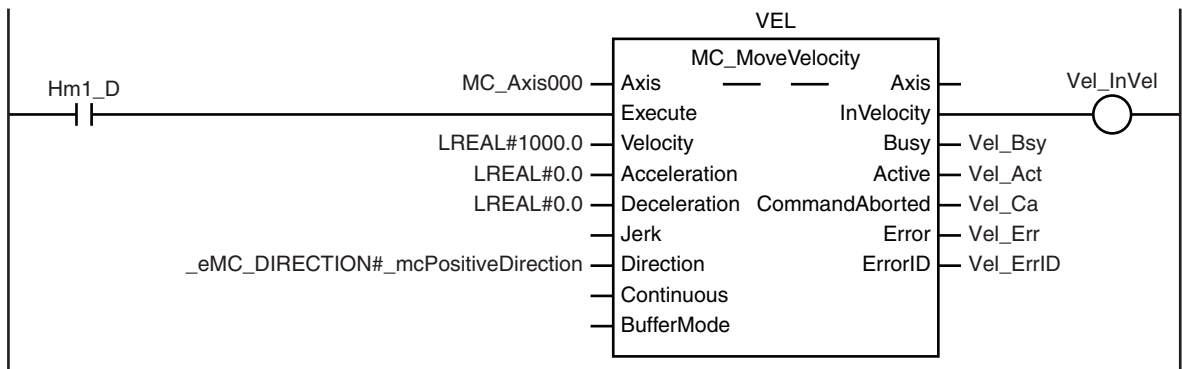

The MC\_CamIn (Start Cam Operation) instruction is executed for axis 2 (slave axis) if *Vel\_InVel* is TRUE for the MC\_MoveVelocity (Velocity Control) instruction and homing is completed for axis 2.

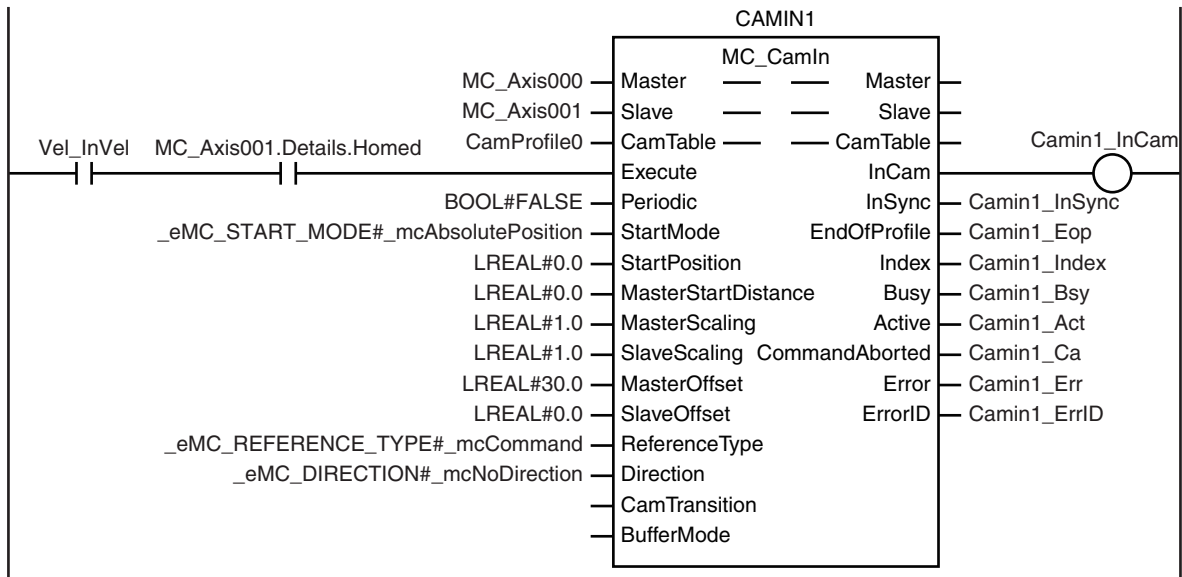

The MC\_CamIn (Start Cam Operation) instruction is executed for axis 3 (slave axis) if *Vel\_InVel* is TRUE for the MC\_MoveVelocity (Velocity Control) instruction and homing is completed for axis 3.

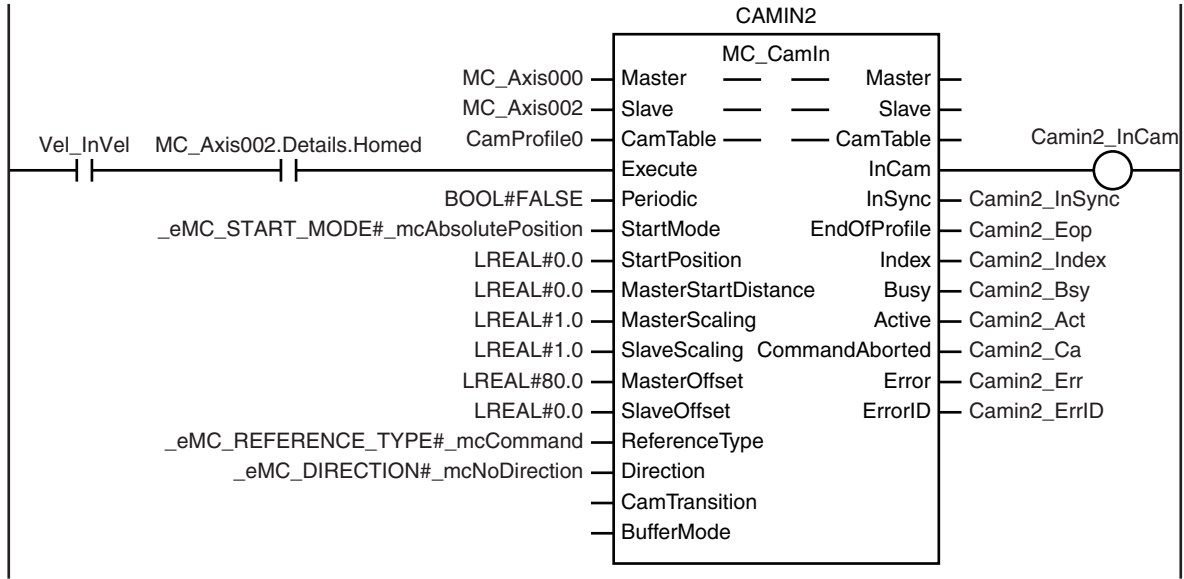

The MC\_CamIn (Start Cam Operation) instruction is executed for axis 4 (slave axis) if *Vel\_InVel* is TRUE for the MC\_MoveVelocity (Velocity Control) instruction and homing is completed for axis 4.

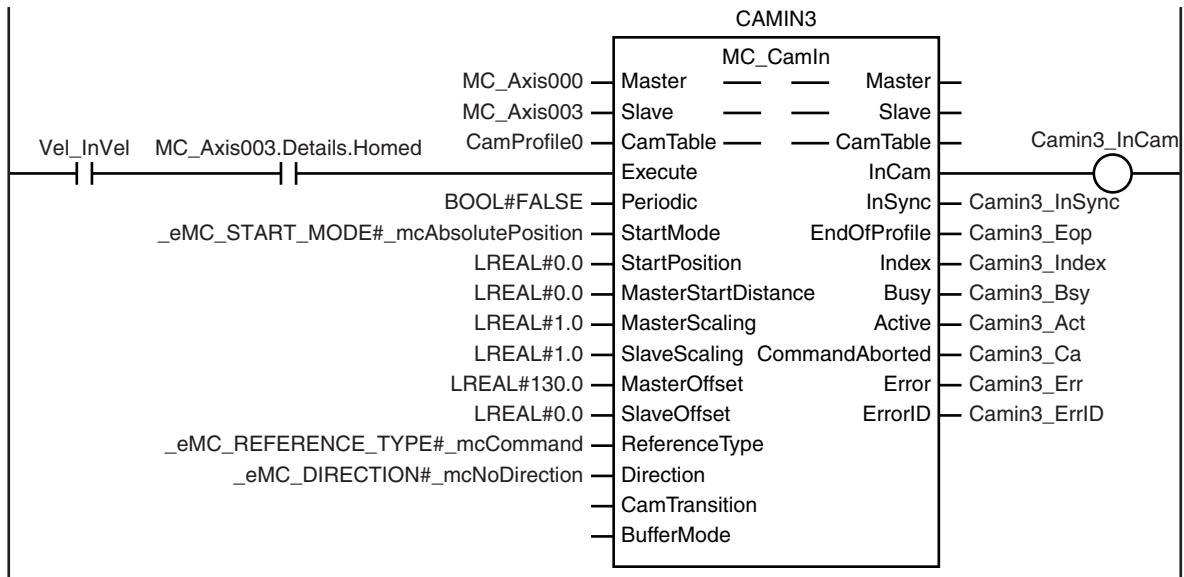

The MC\_CamIn (Start Cam Operation) instruction is executed for axis 5 (slave axis) if *Vel\_InVel* is TRUE for the MC\_MoveVelocity (Velocity Control) instruction and homing is completed for axis 5.

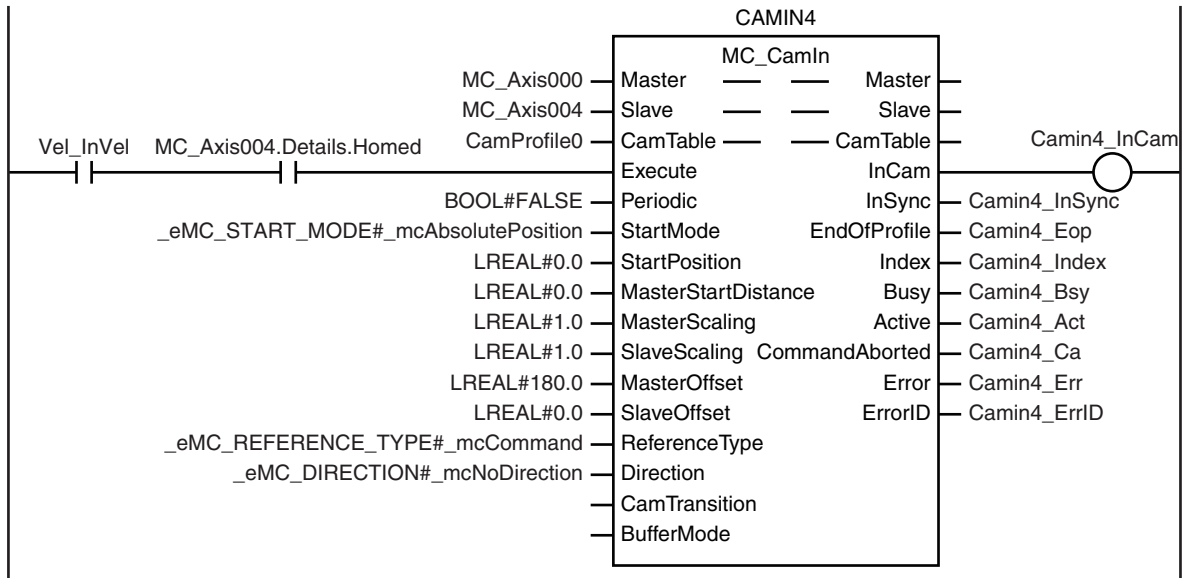

## Structured Text (ST)

### ● Main Variables

Name	Data type	Default	Comment
MC_Axis000	_sAXIS_REF	---	Axis Variable for the master axis, axis 1.
MC_Axis001	_sAXIS_REF	---	Axis Variable for the slave axis, axis 2.
MC_Axis002	_sAXIS_REF	---	Axis Variable for the slave axis, axis 3.
MC_Axis003	_sAXIS_REF	---	Axis Variable for the slave axis, axis 4.
MC_Axis004	_sAXIS_REF	---	Axis Variable for the slave axis, axis 5.
StartPg	BOOL	FALSE	The Servo is turned ON if this variable is TRUE and EtherCAT process data communications are established.
Vel_InVel	BOOL	FALSE	This variable is assigned to the <i>InVelocity</i> output variable from the VEL instance of the MC_MoveVelocity instruction. It is TRUE when the target velocity is reached.
CamProfile0	ARRAY[0..360] OF _sMC_CAM_REF	---	This is the cam data variable. This variable is assigned to the <i>CamTable</i> input variables from the CAMIN1 to CAMIN4 instances of the MC_CamIn instruction. The array elements ARRAY[0..N] are set with the Cam Editor.
Camin1_Ex	BOOL	FALSE	The CAMIN1 to CAMIN4 instances of MC_CamIn are executed when this variable changes to TRUE.
Camin2_Ex	BOOL	FALSE	
Camin3_Ex	BOOL	FALSE	
Camin4_Ex	BOOL	FALSE	

Name	Data type	Default	Comment
InitFlag	BOOL	FALSE	This variable indicates if it is necessary to set the input parameters. Input parameters are set when this variable is FALSE. When setting the input parameters is completed, this variable changes to TRUE.

## ● Timing Chart

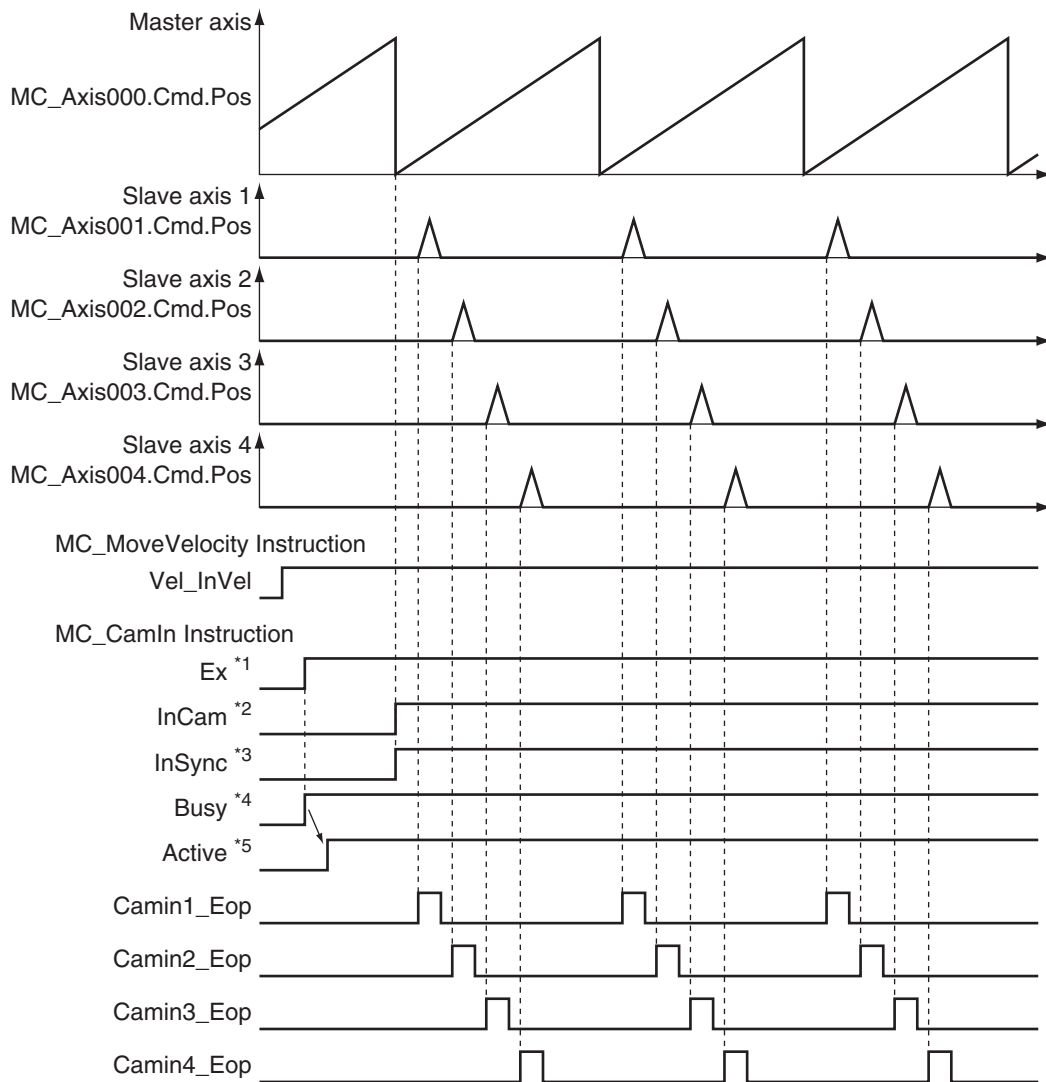

- \*1. The timing is the same for the following: Camin1\_InCam, Camin2\_InCam, Camin3\_InCam, and Camin4\_InCam.
- \*2. The timing is the same for the following: Camin1\_InSync, Camin2\_InSync, Camin3\_InSync, and Camin4\_InSync.  
In this sample, *MasterStartDistance* is 0, so *InSync* changes to TRUE from when the master axis is 0°.
- \*3. The timing is the same for the following: Camin1\_Bsy, Camin2\_Bsy, Camin3\_Bsy, and Camin4\_Bsy.
- \*4. The timing is the same for the following: Camin1\_Act, Camin2\_Act, Camin3\_Act, and Camin4\_Act.

## ● Sample Programming

```
// Processing when input parameters are not set
IF InitFlag=FALSE THEN
```

```

// MC_MoveVelocity Input Parameter
Vel_Vel := LREAL#1000.0;
Vel_Acc := LREAL#0.0;
Vel_Dec := LREAL#0.0;
Vel_Dir := _eMC_DIRECTION#_mcPositiveDirection;

// MC_CamIn Input Parameter
Camin1_Em := TRUE;
Camin1_Sm := _eMC_START_MODE#_mcAbsolutePosition;
Camin1_Sp := LREAL#0.0;
Camin1_Msd := LREAL#0.0;
Camin1_Ms := LREAL#1.0;
Camin1_Ss := LREAL#1.0;
Camin1_Mo := LREAL#30.0;
Camin1_So := LREAL#0.0;
Camin1_Rt := _eMC_REFERENCE_TYPE#_mcCommand;
Camin1_Dir := _eMC_DIRECTION#_mcNoDirection;

Camin2_Em := TRUE;
Camin2_Sm := _eMC_START_MODE#_mcAbsolutePosition;
Camin2_Sp := LREAL#0.0;
Camin2_Msd := LREAL#0.0;
Camin2_Ms := LREAL#1.0;
Camin2_Ss := LREAL#1.0;
Camin2_Mo := LREAL#80.0;
Camin2_So := LREAL#0.0;
Camin2_Rt := _eMC_REFERENCE_TYPE#_mcCommand;
Camin2_Dir := _eMC_DIRECTION#_mcNoDirection;

Camin3_Em := TRUE;
Camin3_Sm := _eMC_START_MODE#_mcAbsolutePosition;
Camin3_Sp := LREAL#0.0;
Camin3_Msd := LREAL#0.0;
Camin3_Ms := LREAL#1.0;
Camin3_Ss := LREAL#1.0;
Camin3_Mo := LREAL#130.0;
Camin3_So := LREAL#0.0;
Camin3_Rt := _eMC_REFERENCE_TYPE#_mcCommand;
Camin3_Dir := _eMC_DIRECTION#_mcNoDirection;

Camin4_Em := TRUE;
Camin4_Sm := _eMC_START_MODE#_mcAbsolutePosition;
Camin4_Sp := LREAL#0.0;
Camin4_Msd := LREAL#0.0;
Camin4_Ms := LREAL#1.0;
Camin4_Ss := LREAL#1.0;
Camin4_Mo := LREAL#180.0;

```

```

Camin4_So := LREAL#0.0;
Camin4_Rt := _eMC_REFERENCE_TYPE#_mcCommand;
Camin4_Dir := _eMC_DIRECTION#_mcNoDirection;

// Change InitFlag to TRUE after setting the input parameters.
InitFlag := TRUE;

END_IF;

// If StartPg is TRUE and the Servo Drive is ready, the Servo for axis 1 is turned
ON.
// If the Servo Drive is not ready, the Servo is turned OFF.
IF (StartPg=TRUE)
AND (MC_Axis000.DrvStatus.Ready=TRUE) THEN
    Pwr1_En:=TRUE;
ELSE
    Pwr1_En:=FALSE;
END_IF;

// If StartPg is TRUE and the Servo Drive is ready, the Servo for axis 2 is turned
ON.
// If the Servo Drive is not ready, the Servo is turned OFF.
IF (StartPg=TRUE)
AND (MC_Axis001.DrvStatus.Ready=TRUE) THEN
    Pwr2_En:=TRUE;
ELSE
    Pwr2_En:=FALSE;
END_IF;

// If StartPg is TRUE and the Servo Drive is ready, the Servo for axis 3 is turned
ON.
// If the Servo Drive is not ready, the Servo is turned OFF.
IF (StartPg=TRUE)
AND (MC_Axis002.DrvStatus.Ready=TRUE) THEN
    Pwr3_En:=TRUE;
ELSE
    Pwr3_En:=FALSE;
END_IF;

// If StartPg is TRUE and the Servo Drive is ready, the Servo for axis 4 is turned
ON.
// If the Servo Drive is not ready, the Servo is turned OFF.
IF (StartPg=TRUE)
AND (MC_Axis003.DrvStatus.Ready=TRUE) THEN
    Pwr4_En:=TRUE;
ELSE
    Pwr4_En:=FALSE;

```



```

END_IF;

// If StartPg is TRUE and the Servo Drive is ready, the Servo for axis 5 is turned
ON.
// If the Servo Drive is not ready, the Servo is turned OFF.
IF (StartPg=TRUE)
AND (MC_Axis004.DrvStatus.Ready=TRUE) THEN
    Pwr5_En:=TRUE;
ELSE
    Pwr5_En:=FALSE;
END_IF;

// If a minor fault level error occurs for axis 1 to axis 5, the error handler for
the device (FaultHandler) is executed.
// Program the FaultHandler according to the device.
IF (MC_Axis000.MFaultLvl.Active=TRUE)
OR (MC_Axis001.MFaultLvl.Active=TRUE)
OR (MC_Axis002.MFaultLvl.Active=TRUE)
OR (MC_Axis003.MFaultLvl.Active=TRUE)
OR (MC_Axis004.MFaultLvl.Active=TRUE) THEN
    FaultHandler();
END_IF;

// If the Servo is ON for axis 1 and home is not defined, the Home instruction is e
xecuted for axis 1.
IF (Pwr1_Status=TRUE) AND (MC_Axis000.Details.Homed=FALSE) THEN
    Hm1_Ex:=TRUE;
END_IF;

// If the Servo is ON for axis 2 and home is not defined, the Home instruction is e
xecuted for axis 2.
IF (Pwr2_Status=TRUE) AND (MC_Axis001.Details.Homed=FALSE) THEN
    Hm2_Ex:=TRUE;
END_IF;

// If the Servo is ON for axis 3 and home is not defined, the Home instruction is e
xecuted for axis 3.
IF (Pwr3_Status=TRUE) AND (MC_Axis002.Details.Homed=FALSE) THEN
    Hm3_Ex:=TRUE;
END_IF;

// If the Servo is ON for axis 4 and home is not defined, the Home instruction is e
xecuted for axis 4.
IF (Pwr4_Status=TRUE) AND (MC_Axis003.Details.Homed=FALSE) THEN
    Hm4_Ex:=TRUE;
END_IF;

```

```

// If the Servo is ON for axis 5 and home is not defined, the Home instruction is e
xecuted for axis 5.
IF (Pwr5_Status=TRUE) AND (MC_Axis004.Details.Homed=FALSE) THEN
    Hm5_Ex:=TRUE;
END_IF;

// After homing is completed for axis 1, MC_MoveVelocity is executed.
IF Hm1_D=TRUE THEN
    Vel_Ex:=TRUE;
END_IF;

// If home is defined for axis 2 and Vel_InVel of MC_MoveVelocity is TRUE, the MC_C
amIn instruction for axis 2 (slave axis) is executed.
IF (Vel_InVel=TRUE) AND (MC_Axis001.Details.Homed=TRUE) THEN
    Camin1_Ex := TRUE;
END_IF;

// If home is defined for axis 3 and Vel_InVel of MC_MoveVelocity is TRUE, the MC_C
amIn instruction for axis 3 (slave axis) is executed.
IF (Vel_InVel=TRUE) AND (MC_Axis002.Details.Homed=TRUE) THEN
    Camin2_Ex := TRUE;
END_IF;

// If home is defined for axis 4 and Vel_InVel of MC_MoveVelocity is TRUE, the MC_C
amIn instruction for axis 4 (slave axis) is executed.
IF (Vel_InVel=TRUE) AND (MC_Axis003.Details.Homed=TRUE) THEN
    Camin3_Ex := TRUE;
END_IF;

// If home is defined for axis 5 and Vel_InVel of MC_MoveVelocity is TRUE, the MC_C
amIn instruction for axis 5 (slave axis) is executed.
IF (Vel_InVel=TRUE) AND (MC_Axis004.Details.Homed=TRUE) THEN
    Camin4_Ex := TRUE;
END_IF;

// MC_Power for axis 1
PWR1(
    Axis := MC_Axis000,
    Enable := Pwr1_En,
    Status => Pwr1_Status,
    Busy => Pwr1_Bsy,
    Error => Pwr1_Err,
    ErrorID => Pwr1_ErrID
);

// MC_Power for axis 2
PWR2(

```

```

    Axis := MC_Axis001,
    Enable := Pwr2_En,
    Status => Pwr2_Status,
    Busy => Pwr2_Bsy,
    Error => Pwr2_Err,
    ErrorID => Pwr2_ErrID
);

// MC_Power for axis 3
PWR3(
    Axis := MC_Axis002,
    Enable := Pwr3_En,
    Status => Pwr3_Status,
    Busy => Pwr3_Bsy,
    Error => Pwr3_Err,
    ErrorID => Pwr3_ErrID
);

// MC_Power for axis 4
PWR4(
    Axis := MC_Axis003,
    Enable := Pwr4_En,
    Status => Pwr4_Status,
    Busy => Pwr4_Bsy,
    Error => Pwr4_Err,
    ErrorID => Pwr4_ErrID
);

// MC_Power for axis 5
PWR5(
    Axis := MC_Axis004,
    Enable := Pwr5_En,
    Status => Pwr5_Status,
    Busy => Pwr5_Bsy,
    Error => Pwr5_Err,
    ErrorID => Pwr5_ErrID
);

// MC_Home for axis 1
HM1(
    Axis := MC_Axis000,
    Execute := Hml_Ex,
    Done => Hml_D,
    Busy => Hml_Bsy,
    CommandAborted => Hml_Ca,
    Error => Hml_Err,
    ErrorID => Hml_ErrID
);

```

```
);

// MC_Home for axis 2
HM2 (
    Axis := MC_Axis001,
    Execute := Hm2_Ex,
    Done => Hm2_D,
    Busy => Hm2_Bsy,
    CommandAborted => Hm2_Ca,
    Error => Hm2_Err,
    ErrorID => Hm2_ErrID
);

// MC_Home for axis 3
HM3 (
    Axis := MC_Axis002,
    Execute := Hm3_Ex,
    Done => Hm3_D,
    Busy => Hm3_Bsy,
    CommandAborted => Hm3_Ca,
    Error => Hm3_Err,
    ErrorID => Hm3_ErrID
);

// MC_Home for axis 4
HM4 (
    Axis := MC_Axis003,
    Execute := Hm4_Ex,
    Done => Hm4_D,
    Busy => Hm4_Bsy,
    CommandAborted => Hm4_Ca,
    Error => Hm4_Err,
    ErrorID => Hm4_ErrID
);

// MC_Home for axis 5
HM5 (
    Axis := MC_Axis004,
    Execute := Hm5_Ex,
    Done => Hm5_D,
    Busy => Hm5_Bsy,
    CommandAborted => Hm5_Ca,
    Error => Hm5_Err,
    ErrorID => Hm5_ErrID
);

// MC_MoveVelocity
```

```

VEL(
    Axis := MC_Axis000,
    Execute := Vel_Ex,
    Velocity := Vel_Vel,
    Acceleration := Vel_Acc,
    Deceleration := Vel_Dec,
    Direction := Vel_Dir,
    InVelocity => Vel_InVel,
    Busy => Vel_Bsy,
    Active => Vel_Act,
    CommandAborted => Vel_Ca,
    Error => Vel_Err,
    ErrorID => Vel_ErrID
);

// MC_CamIn
CAMIN1(
    Master := MC_Axis000,
    Slave := MC_Axis001,
    CamTable := CamProfile0,
    Execute := Camin1_Ex,
    Periodic := Camin1_Em,
    StartMode := Camin1_Sm,
    StartPosition := Camin1_Sp,
    MasterStartDistance := Camin1_Msd,
    MasterScaling := Camin1_Ms,
    SlaveScaling := Camin1_Ss,
    MasterOffset := Camin1_Mo,
    SlaveOffset := Camin1_So,
    ReferenceType := Camin1_Rt,
    Direction := Camin1_Dir,
    InCam => Camin1_InCam,
    InSync => Camin1_InSync,
    EndOfProfile => Camin1_Eop,
    Index => Camin1_Index,
    Busy => Camin1_Bsy,
    Active => Camin1_Act,
    CommandAborted => Camin1_Ca,
    Error => Camin1_Err,
    ErrorID => Camin1_ErrID
);

CAMIN2(
    Master := MC_Axis000,
    Slave := MC_Axis002,
    CamTable := CamProfile0,
    Execute := Camin2_Ex,

```

```
Periodic := Camin2_Em,  
StartMode := Camin2_Sm,  
StartPosition := Camin2_Sp,  
MasterStartDistance := Camin2_Msd,  
MasterScaling := Camin2_Ms,  
SlaveScaling := Camin2_Ss,  
MasterOffset := Camin2_Mo,  
SlaveOffset := Camin2_So,  
ReferenceType := Camin2_Rt,  
Direction := Camin2_Dir,  
InCam => Camin2_InCam,  
InSync => Camin2_InSync,  
EndOfProfile => Camin2_Eop,  
Index => Camin2_Index,  
Busy => Camin2_Bsy,  
Active => Camin2_Act,  
CommandAborted => Camin2_Ca,  
Error => Camin2_Err,  
ErrorID => Camin2_ErrID  
);
```

```
CAMIN3(  
Master := MC_Axis000,  
Slave := MC_Axis003,  
CamTable := CamProfile0,  
Execute := Camin3_Ex,  
Periodic := Camin3_Em,  
StartMode := Camin3_Sm,  
StartPosition := Camin3_Sp,  
MasterStartDistance := Camin3_Msd,  
MasterScaling := Camin3_Ms,  
SlaveScaling := Camin3_Ss,  
MasterOffset := Camin3_Mo,  
SlaveOffset := Camin3_So,  
ReferenceType := Camin3_Rt,  
Direction := Camin3_Dir,  
InCam => Camin3_InCam,  
InSync => Camin3_InSync,  
EndOfProfile => Camin3_Eop,  
Index => Camin3_Index,  
Busy => Camin3_Bsy,  
Active => Camin3_Act,  
CommandAborted => Camin3_Ca,  
Error => Camin3_Err,  
ErrorID => Camin3_ErrID  
);
```

```
CAMIN4 (  
    Master := MC_Axis000,  
    Slave := MC_Axis004,  
    CamTable := CamProfile0,  
    Execute := Camin4_Ex,  
    Periodic := Camin4_Em,  
    StartMode := Camin4_Sm,  
    StartPosition := Camin4_Sp,  
    MasterStartDistance := Camin4_Msd,  
    MasterScaling := Camin4_Ms,  
    SlaveScaling := Camin4_Ss,  
    MasterOffset := Camin4_Mo,  
    SlaveOffset := Camin4_So,  
    ReferenceType := Camin4_Rt,  
    Direction := Camin4_Dir,  
    InCam => Camin4_InCam,  
    InSync => Camin4_InSync,  
    EndOfProfile => Camin4_Eop,  
    Index => Camin4_Index,  
    Busy => Camin4_Bsy,  
    Active => Camin4_Act,  
    CommandAborted => Camin4_Ca,  
    Error => Camin4_Err,  
    ErrorID => Camin4_ErrID  
);
```

# MC\_CamOut

The MC\_CamOut instruction ends cam operation for the axis specified with the input parameter.

Instruction	Name	FB/ FUN	Graphic expression	ST expression
MC_CamOut	End Cam Operation	FB		<pre>MC_CamOut_instance (   Slave :=parameter,   Execute :=parameter,   Deceleration :=parameter,   Jerk :=parameter,   OutMode :=parameter,   Done =&gt;parameter,   Busy =&gt;parameter,   CommandAborted =&gt;parameter,   Error =&gt;parameter,   ErrorID =&gt;parameter );</pre>

## Variables

### Input Variables

Name	Meaning	Data type	Valid range	De- fault	Description
Execute	Execute	BOOL	TRUE or FALSE	FALSE	The instruction is executed when this variable changes to TRUE.
Deceleration	Deceleration Rate	LREAL	Non-negative number	0	Specify the deceleration rate. The unit is command units/s <sup>2</sup> . <sup>*1</sup>
Jerk (Reserved)	Jerk	LREAL	0	0	(Reserved)
OutMode (Reserved)	Sync End Mode Selection	_eMC_OUT_MO DE	0: _mcStop	0 <sup>*2</sup>	(Reserved)

\*1. Refer to *Unit Conversion Settings* in the *NJ/NX-series CPU Unit Motion Control User's Manual (Cat. No. W507)*.

\*2. The default value for an enumeration variable is actually not the number, but the enumerator.

### Output Variables

Name	Meaning	Data type	Valid range	Description
Done	Done	BOOL	TRUE or FALSE	TRUE when the instruction is completed.
Busy	Executing	BOOL	TRUE or FALSE	TRUE when the instruction is acknowledged.
CommandAborted	Command Aborted	BOOL	TRUE or FALSE	TRUE when the instruction is aborted.



Name	Meaning	Data type	Valid range	Description
Error	Error	BOOL	TRUE or FALSE	TRUE while there is an error.
ErrorID	Error Code	WORD	*1	Contains the error code when an error occurs. A value of 16#0000 indicates normal execution.

\*1. The upper four digits of the event code give the error code for ErrorID. Refer to the *NJ/NX-series Troubleshooting Manual (Cat. No. W503)* for the event codes.

### ● Output Variable Update Timing

Name	Timing for changing to TRUE	Timing for changing to FALSE
Done	When the velocity reaches 0.	<ul style="list-style-type: none"> <li>When <i>Execute</i> is TRUE and changes to FALSE.</li> <li>After one period when <i>Execute</i> is FALSE.</li> </ul>
Busy	When <i>Execute</i> changes to TRUE.	<ul style="list-style-type: none"> <li>When <i>Done</i> changes to TRUE.</li> <li>When <i>Error</i> changes to TRUE.</li> <li>When <i>CommandAborted</i> changes to TRUE.</li> </ul>
CommandAborted	<ul style="list-style-type: none"> <li>When this instruction is aborted because another motion control instruction was executed with the Buffer Mode set to <b>Aborting</b>.</li> <li>When this instruction is canceled due to an error.</li> <li>When this instruction is executed while there is an error.</li> <li>When you start this instruction during MC_Stop instruction execution.</li> </ul>	<ul style="list-style-type: none"> <li>When <i>Execute</i> is TRUE and changes to FALSE.</li> <li>After one period when <i>Execute</i> is FALSE.</li> </ul>
Error	When there is an error in the execution conditions or input parameters for the instruction.	When the error is cleared.

## In-Out Variables

Name	Meaning	Data type	Valid range	Description
Slave	Slave Axis	_sAXIS_REF	---	Specify the slave axis. *1

\*1. Specify a user-defined Axis Variable that was created in the Axis Basic Settings of the Sysmac Studio (default: MC\_Axis\*) or a system-defined axis variable name (\_MC\_AX[\*], \_MC1\_AX[\*], or \_MC2\_AX[\*]).  
If you use Sysmac Studio version 1.29 or higher, you can specify the system-defined axis variable name for AT specification of a user-defined variable. This will allow you to specify the user-defined variable.  
If you use Sysmac Studio version 1.28 or lower, do not specify any user-defined variable created in the variable table.

## Function

- The MC\_CamOut instruction disables cam operation of the slave axis.
- When *Execute* changes to TRUE, the axis starts decelerating towards 0 velocity at the deceleration rate specified with *Deceleration* (Deceleration Rate).
- When the command velocity reaches 0, the instruction is completed.
- If you execute this instruction on an axis that is not in cam operation, an error will occur.



### Precautions for Correct Use

- Cam data variables are global variables. You can therefore access or change the values of cam data variables from more than one task. If you change the values of cam data variables from more than one task, program the changes so that there is no competition in writing the value from more than one task.
- If you use exclusive control of global variables between tasks for a cam data variable, do not use the cam data variable for motion control instructions in a task that does not control the variable. An Incorrect Cam Table Specification error (error code: 5439 hex) will occur.

## Timing Charts

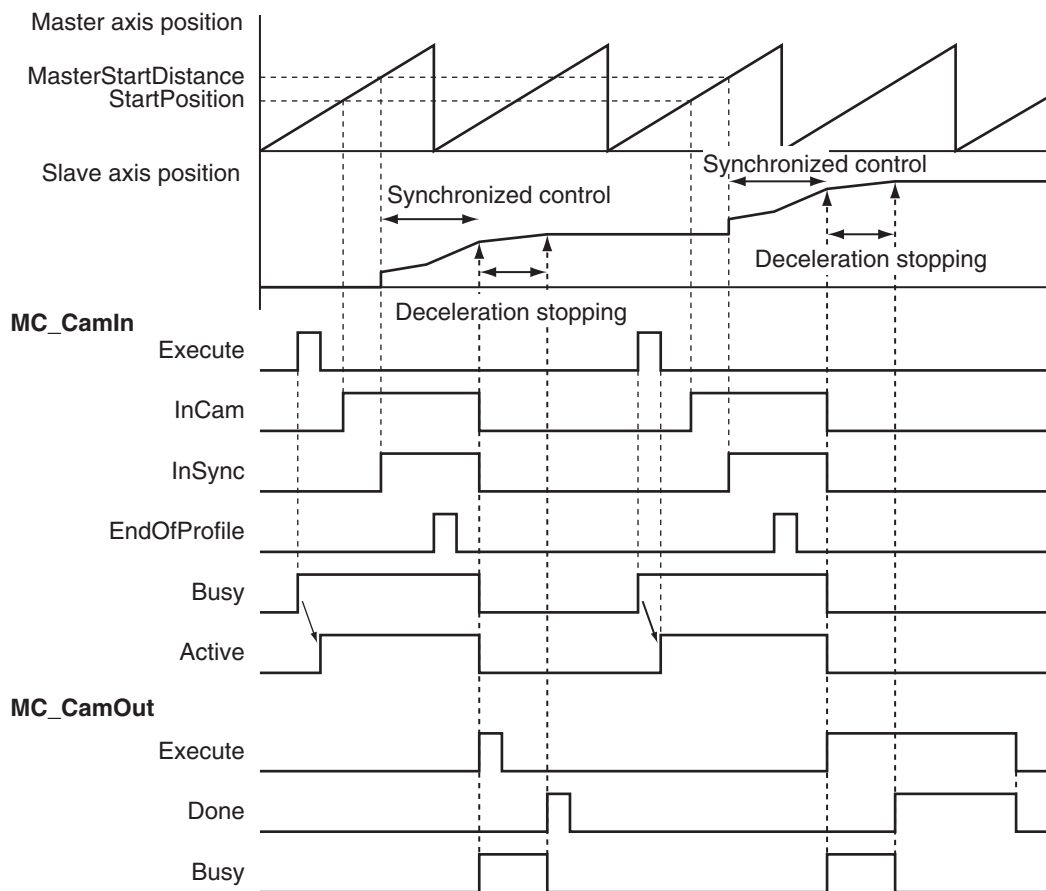

## Aborting the Instruction

If an axis error occurs for the slave axis during execution of this instruction, *CommandAborted* changes to TRUE and *Busy* (Executing) changes to FALSE.

The axis will decelerate at the rate specified with *Deceleration* (Deceleration Rate) for this instruction.

Refer to the *NJ/NX-series Troubleshooting Manual (Cat. No. W503)* for information on axis errors.

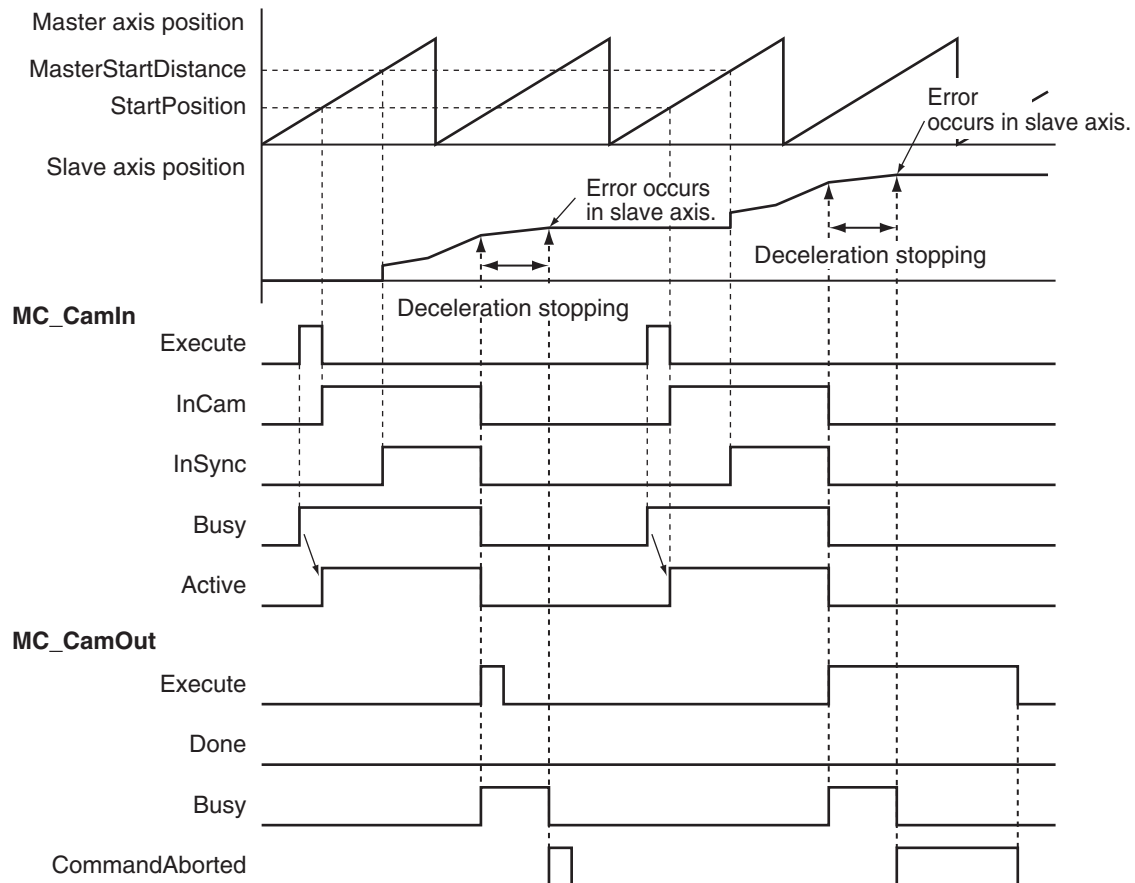

## Re-execution of Motion Control Instructions

This instruction cannot be re-executed.

A Motion Control Instruction Re-execution Disabled error (error code: 543B hex) occurs if re-execution is attempted.

## Multi-execution of Motion Control Instructions

### ● Execution during Execution of Other Instructions

If you execute this instruction while the MC\_CamIn (Start Cam Operation) instruction is in execution, *CommandAborted* for the MC\_CamIn instruction will change to TRUE and *Busy* (Executing) for this instruction will change to TRUE.

If this instruction is executed when the MC\_CamIn (Start Cam Operation) instruction is not in execution, an error will occur and change *Error* to TRUE.

### ● Execution of Other Instructions during Instruction Execution

To use multi-execution of motion instructions for this instruction, specify the slave axis.

If you execute another instruction during execution of this instruction, you can set the Buffer Mode to either **Aborting** or **Buffered**.

## Errors

If an error occurs during instruction execution, *Error* will change to TRUE.

You can find out the cause of the error by referring to the value output by *ErrorID* (Error Code).

### ● Timing Chart When Error Occurs

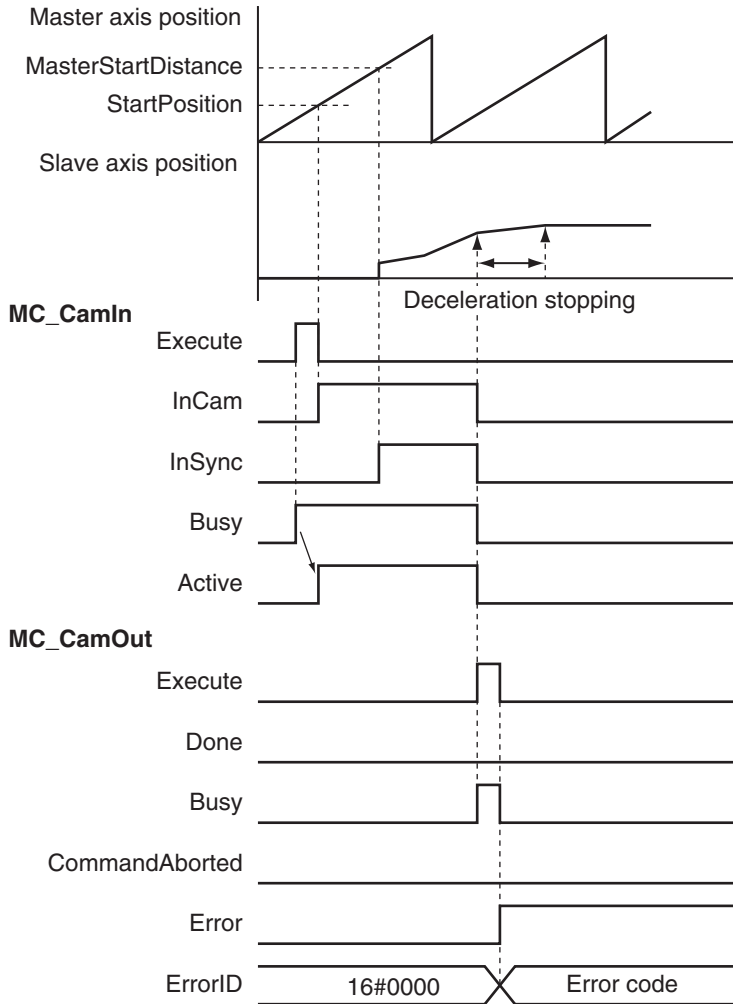

### ● Error Codes

Refer to the *NJ/NX-series Troubleshooting Manual (Cat. No. W503)* for instruction errors.

# MC\_CamMonitor

The MC\_CamMonitor instruction monitors information on the cam operation.

Instruction	Name	FB/ FUN	Graphic expression	ST expression
MC_CamMonitor	Cam Monitor	FB		<pre>MC_CamMonitor_instance(   Axis :=parameter ,   CamTable :=parameter,   CamMonitorValue :=parameter,   Enable :=parameter,   MasterScaling :=parameter,   SlaveScaling :=parameter,   CamMonitorMode :=parameter,   Enabled =&gt;parameter,   Valid =&gt;parameter,   Busy =&gt;parameter,   Error =&gt;parameter,   ErrorID =&gt;parameter );</pre>



## Version Information

A CPU Unit with the following unit version and Sysmac Studio version 1.28 or higher are required to use this instruction.

CPU Unit	Compatible unit versions
NX102 CPU Unit	Version 1.32 or later
NX1P2 CPU Unit	Version 1.21 or later
NJ-series CPU Unit	Version 1.21 or later

## Variables

### Input Variables

Name	Meaning	Data type	Valid range	Default	Description
Enable	Enable	BOOL	TRUE or FALSE	FALSE	The instruction is executed while the value of this variable is TRUE.
MasterScaling	Master Coefficient	LREAL	Positive value (>0.0)	1.0	The phase of the master axis is extended or contracted by using the specified scale.
SlaveScaling	Slave Axis Coefficient	LREAL	Positive value (>0.0)	1.0	The displacement of the slave axis is extended or contracted by using the specified scale.
CamMonitorMode	Cam Monitor Mode Selection	_eMC_CAM_MONI-TOR_MODE	0: _mcCalcCam-DistanceDiff	0*1	Specifies information on the cam operation to be monitored. 0: Displacement Following Error Calculation

\*1. The default value for an enumeration variable is actually not the number, but the enumerator.

## Output Variables

Name	Meaning	Data type	Valid range	Description
Enabled	Enable	BOOL	TRUE or FALSE	TRUE when control is in progress.
Valid	Cam Monitor Values Valid	BOOL	TRUE or FALSE	TRUE when <i>CamMonitorValue</i> (Cam Monitor Values) is a valid value.
Busy	Executing	BOOL	TRUE or FALSE	TRUE when the instruction is acknowledged.
Error	Error	BOOL	TRUE or FALSE	TRUE while there is an error.
ErrorID	Error Code	WORD	*1	Contains the error code when an error occurs. A value of 16#0000 indicates normal execution.

\*1. The upper four digits of the event code give the error code for ErrorID. Refer to the *NJ/NX-series Troubleshooting Manual (Cat. No. W503)* for the event codes.

### ● Output Variable Update Timing

Name	Timing for changing to TRUE	Timing for changing to FALSE
Enabled	When <i>Enable</i> changes to TRUE.	<ul style="list-style-type: none"> <li>After one period when <i>Enable</i> is FALSE.</li> <li>When <i>Error</i> changes to TRUE.</li> </ul>
Valid	When the value output to <i>CamMonitorValue</i> (Cam Monitor Values) is valid.	<ul style="list-style-type: none"> <li>After one period when <i>Enable</i> is FALSE.</li> <li>When <i>Error</i> changes to TRUE.</li> <li>When any of the conditions for changing <i>Valid</i> to FALSE is satisfied. *1</li> </ul>
Busy	When <i>Enable</i> changes to TRUE.	<ul style="list-style-type: none"> <li>When <i>Enable</i> changes to FALSE.</li> <li>When <i>Error</i> changes to TRUE.</li> </ul>
Error	When there is an error in the execution conditions or input parameters for the instruction.	When the error is cleared.

\*1. Refer to *Precautions for Correct Use* on page 3-245 for the conditions for changing *Valid* to FALSE.

## In-Out Variables

Name	Meaning	Data type	Valid range	Description
Axis	Axis	_sAXIS_REF	---	Specifies the axis. *1
CamTable	Cam Table	ARRAY[0..N] OF_sMC_CAM_REF	---	Specifies the cam data structure _sMC_CAM_REF array variable as the cam table. *2
CamMonitorValue	Cam Monitor Values	_sMC_CAM_MONITOR_DISTANCE-DIFF	---	Outputs information on the cam operation. *3

- \*1. Specify a user-defined Axis Variable that was created in the Axis Basic Settings of the Sysmac Studio (default: MC\_Axis\*) or a system-defined axis variable name (`_MC_AX[*]`, `_MC1_AX[*]`, or `_MC2_AX[*]`).  
If you use Sysmac Studio version 1.29 or higher, you can specify the system-defined axis variable name for AT specification of a user-defined variable. This will allow you to specify the user-defined variable.  
If you use Sysmac Studio version 1.28 or lower, do not specify any user-defined variable created in the variable table.
- \*2. "N" in the array variable is set automatically by the Sysmac Studio. Specify a cam data variable that was created on Cam Editor of the Sysmac Studio.
- \*3. Information on the cam operation to be monitored is specified by *CamMonitorMode* (Cam Monitor Mode Selection).

### ● **\_sMC\_CAM\_MONITOR\_DISTANCEDIFF (Cam Monitor Displacement Following Error)**

Name	Meaning	Data type	Description
CamProfileData	Cam Profile Data	_sMC_CAM_PROFILE_DATA	Contains basic information on the cam operation such as the phase and displacement.
DistanceDiff	Displacement Following Error	LREAL	Contains the difference between the axis command position and <i>Distance</i> (Slave Axis Displacement).

### ● **\_sMC\_CAM\_PROFILE\_DATA (Cam Profile Data)**

Name	Meaning	Data type	Description
Phase	Master Axis Phase	LREAL	Outputs the current phase.
Distance	Slave Axis Displacement	LREAL	Outputs the current displacement.
MasterReferencePosition	Master Axis Reference Position	LREAL	Position of the master axis used as reference for the current phase (phase=0.0)
SlaveReferencePosition	Slave Axis Reference Position	LREAL	Position of the slave axis used as reference for the current displacement (displacement=0.0)
PhaseShift	Phase Shift Amount	LREAL	Phase shift amount shifted with MC_Phasing (Shift Master Axis Phase) during cam motion
OffsetPosition	Position Offset	LREAL	Position offset compensated with the MC_SyncOffsetPosition (Cyclic Synchronous Position Offset Compensation) instruction or MC_OffsetPosition (Position Offset Compensation) instruction

The relationships among the displacement following error, master axis reference position, and slave axis reference position are shown below.

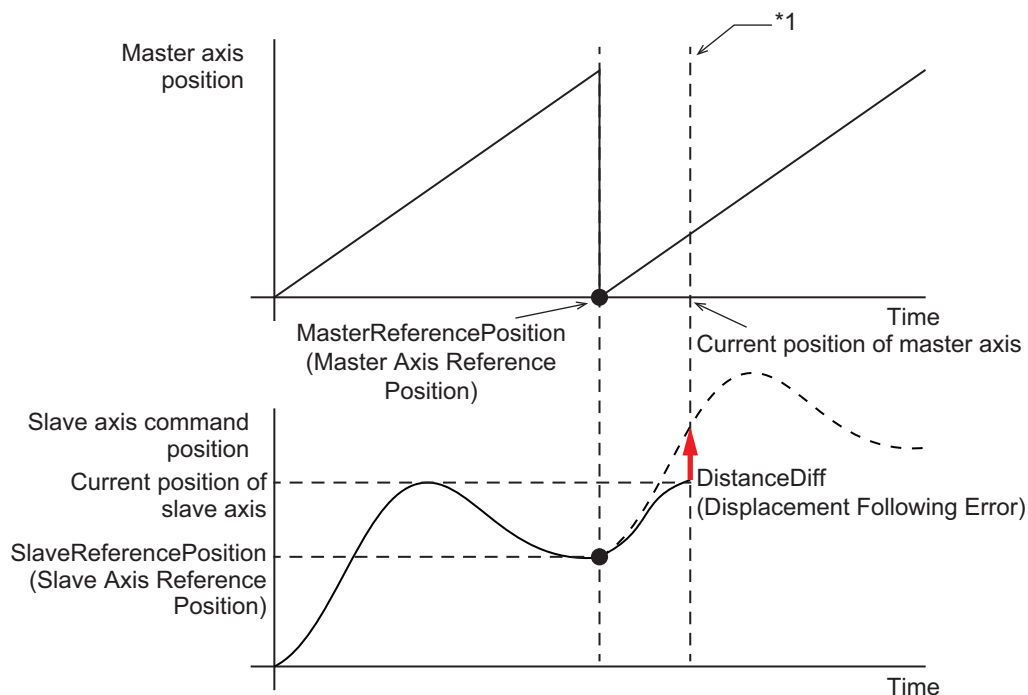

\*1. A value at this point is monitored.

Also, the relationship between the master axis phase and the slave axis displacement is shown below.

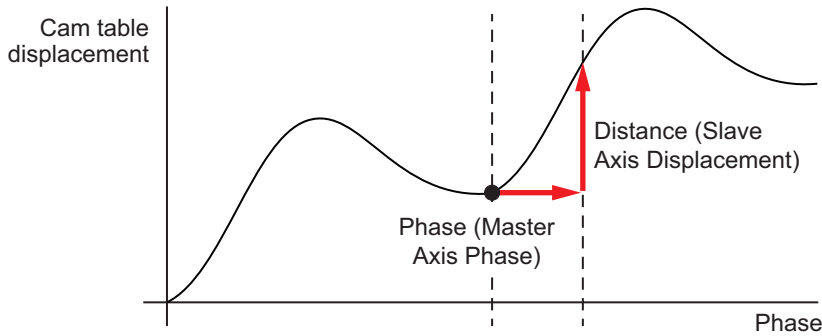

## Function

The MC\_CamMonitor (Cam Monitor) instruction monitors information on the cam operation that is specified with *CamTable* (Cam Table) and *CamMonitorMode* (Cam Monitor Mode Selection).

Based on the phase of the master axis in the MC\_CamIn (Start Cam Operation) instruction that is executed immediately before this instruction, the cam operation information specified with *CamTable* (Cam Table) and *CamMonitorMode* (Cam Monitor Mode Selection) is output to *CamMonitorValue* (Cam Monitor Values).

When *InSync* (In Sync) for the MC\_CamIn (Start Cam Operation) instruction changes to TRUE after the execution of the MC\_CamIn (Start Cam Operation) instruction, *Valid* (Cam Monitor Values Valid) changes to TRUE and *CamMonitorValue* (Cam Monitor Values) is updated.

After the MC\_CamIn (Start Cam Operation) instruction is aborted, this instruction can be executed even if *CommandAborted* (Command Aborted) for the MC\_CamIn instruction changes to TRUE.

You can use this instruction in the following cases.

- If the cam operation currently in motion is interrupted due to an error in the slave axis, for example, monitor the conditions for restarting the MC\_CamIn (Start Cam Operation) instruction, based on the current phase of the master axis.
- When you change the cam table for such a purpose as setup change, monitor the conditions for restarting the MC\_CamIn (Start Cam Operation) instruction after the change of the cam table, based on the current phase of the master axis.

The MC\_CamIn (Start Cam Operation) instruction can be executed in the middle of the cam table by setting *MasterOffset* (Master Offset) and *SlaveOffset* (Slave Offset).

Based on *Phase* (Master Axis Phase) and *Distance* (Slave Axis Displacement) that are monitored by this instruction, set each offset for the MC\_CamIn (Start Cam Operation) instruction to be executed later.

Refer to *MC\_CamIn* on page 3-173 for details on how to set the offsets.

## CamTable (Cam Table)

You can specify *CamTable* (Cam Table).

If the end point of the phase specified with *CamTable* (Cam Table) is different from that of the cam table currently in use, perform scaling so that it can be moved to the same phase of the cam table currently in use as shown below, and calculate the phase.



Obtain a value by eliminating influence of scaling from the obtained phase, and output the value to *CamMonitorValue* (Cam Monitor Values) as the phase.

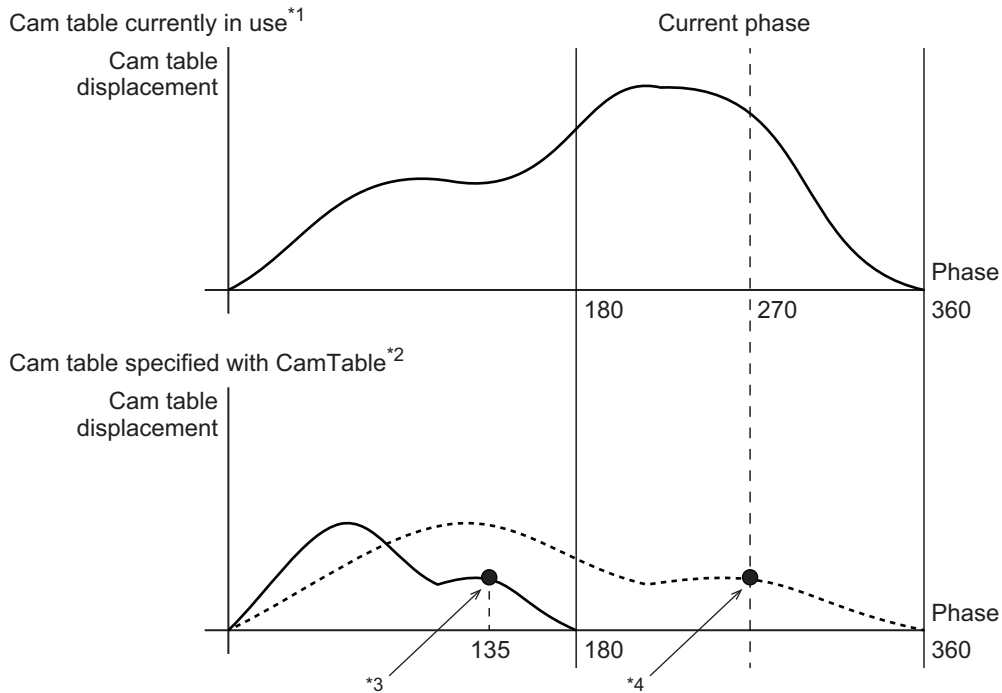

\*1. End point of phase: 360

\*2. End point of phase: 180

\*3. *Phase* (Master Axis Phase) is output after eliminating influence of scaling.

\*4. Calculated based on the cam table after scaling and the current phase.

The phase to be output to *CamMonitorValue* (Cam Monitor Values) is as follows.

$$\begin{aligned} \text{Phase} &= \frac{\text{Current phase}}{\text{End point of the phase of the cam table currently in use}} \times \text{End point of the phase of the cam table in CamTable} \\ &= \frac{270}{360} \times 180 \\ &= 135 \end{aligned}$$

## CamMonitorMode (Cam Monitor Mode Selection)

### ● Displacement Following Error Calculation

The following describes the case in which 0: *\_mcCalcCamDistanceDiff* is selected for *CamMonitorMode* (Cam Monitor Mode Selection).

*Phase* (Master Axis Phase) of the cam profile curve calculated from the position of the master axis, *Distance* (Slave Axis Displacement) obtained from *Phase*, and *DistanceDiff* (Displacement Following Error) of the command position of the slave axis are monitored.

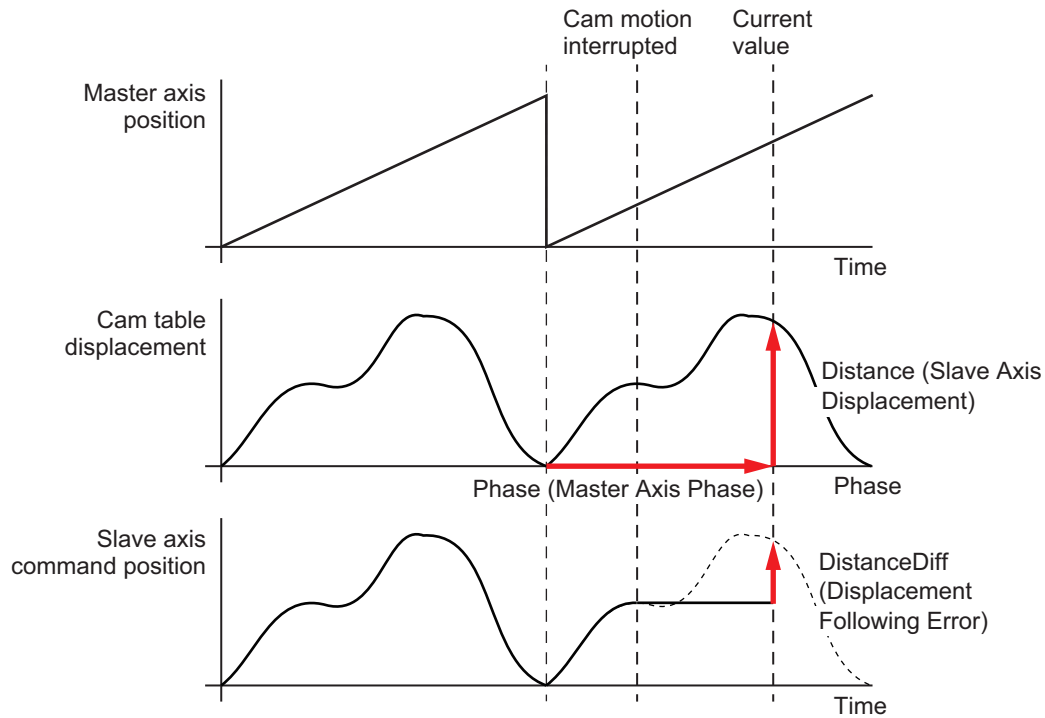

The command current position of the slave axis can be moved onto the cam profile curve by using the monitored *DistanceDiff* (Displacement Following Error).

Moreover, if you reverse the positive or negative sign of the values of *Phase* (Master Phase) and *Distance* (Slave Axis Displacement) and assign the values to *MasterOffset* (Master Offset) and *SlaveOffset* (Slave Offset) for the MC\_CamIn (Start Cam Operation) instruction, the cam motion of the slave axis can be activated again in the middle of the cam profile curve by executing the MC\_CamIn instruction.

The following shows the timing chart for an application example in which the MC\_CamMonitor (Cam Monitor) instruction is executed while the MC\_CamIn (Start Cam Operation) instruction is executed, and then the MC\_CamIn (Start Cam Operation) is aborted.

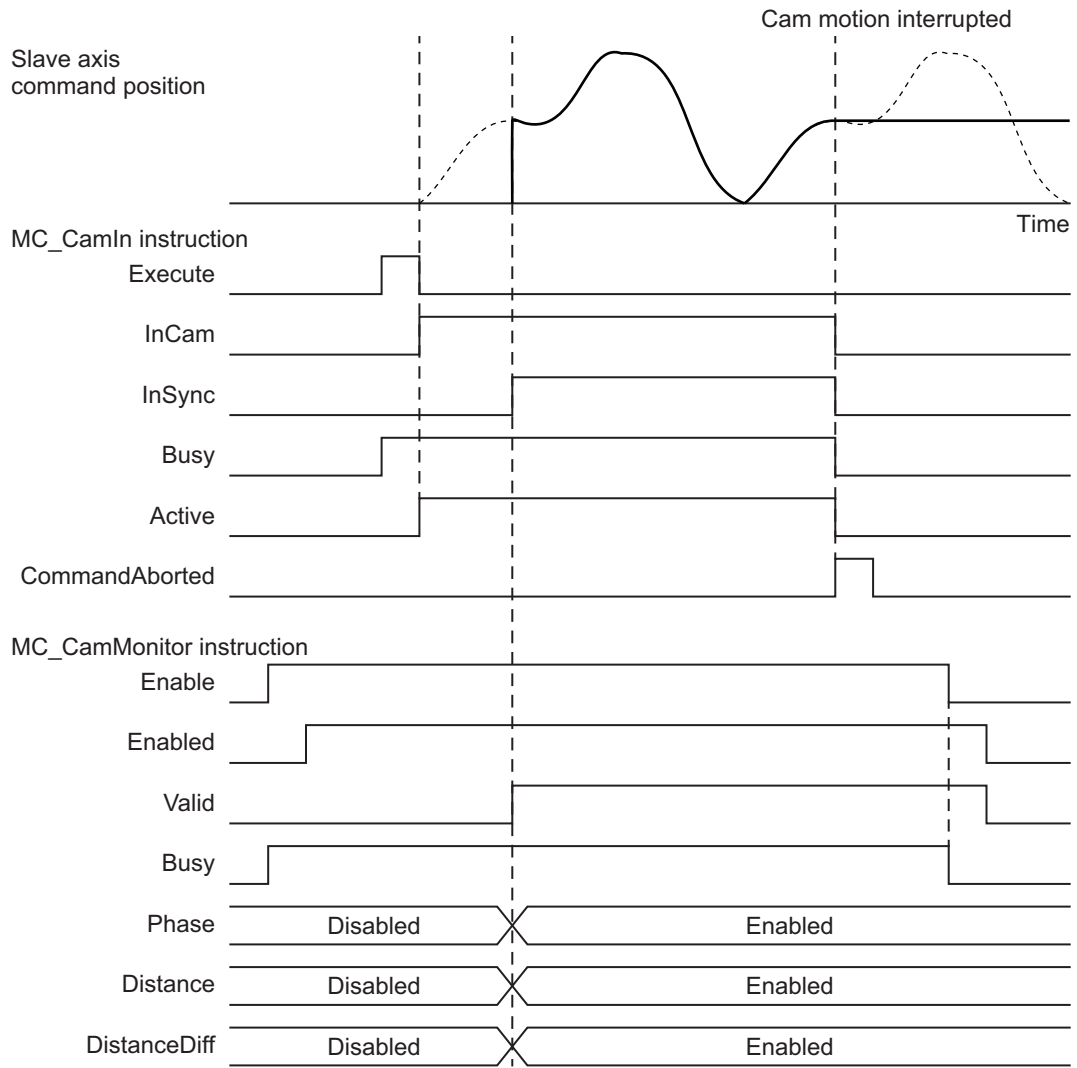



### Precautions for Correct Use

A displacement following error is calculated based on the *MasterReferencePosition* (Master Axis Reference Position) and *SlaveReferencePosition* (Slave Axis Reference Position), instead of the start position of the cam motion.

The following shows an example with a feeding cam for which the displacement of the end point is not 0.

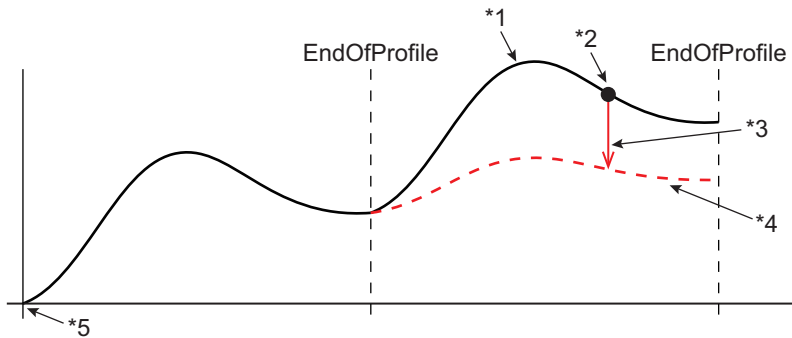

- \*1. Cam table currently in use
- \*2. Command current position for slave axis
- \*3. Displacement following error to be calculated
- \*4. Cam table specified in *CamTable* (Cam Table)
- \*5. Position in which the cam operation starts

In the calculation of the displacement following error, the phase to be monitored is calculated based on the phase shift amount calculated in the preceding period.

Accordingly, while the MC\_Phasing instruction is in execution, the calculation is based on the phase shift amount for the control period immediately before the current one, and therefore the calculation result does not match a value calculated by the MC\_CamIn (Start Cam Operation) instruction.

## Re-execution of Motion Control Instructions

You cannot re-execute motion instructions with enable-type inputs.

## Multi-execution of Motion Control Instructions

For details on multi-execution of motion control instructions, refer to the *NJ/NX-series CPU Unit Motion Control User's Manual (Cat. No. W507)*.

## Errors

If an error occurs during instruction execution, *Error* will change to TRUE.

You can find out the cause of the error by referring to the value output by *ErrorID* (Error Code).

### ● Timing Chart When Error Occurs

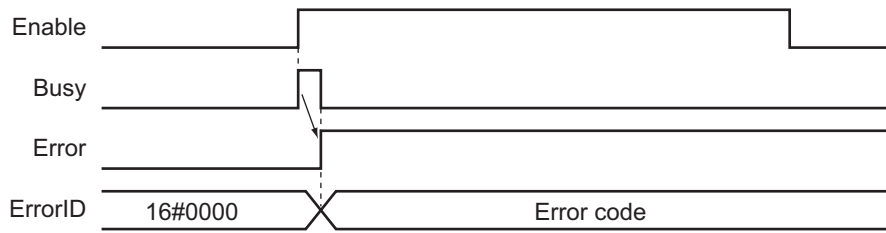

### ● Error Codes

Refer to the *NJ/NX-series Troubleshooting Manual (Cat. No. W503)* for instruction errors.

## Precautions for Correct Use

In any of the following cases, *Valid* (Cam Monitor Values Valid) changes to FALSE, and *CamMonitorValue* (Cam Monitor Values) is not updated.

- The axis status specified by *Axis* (Axis) transitions to Synchronized (Synchronized Motion) due to the execution of a synchronized control instruction.
- The *MC\_GenerateCamTable* (Generate Cam Table) instruction is being executed for the cam profile curve specified in *CamTable* (Cam Table).
- For the axis specified by *Axis* (Axis), the *MC\_Home* (Home) instruction, *MC\_HomeWithParameter* (Home with Parameters) instruction, or *MC\_SetPosition* (Set Position) instruction is executed.
- **Absolute encoder (ABS)** is set for **Encoder Type** in **Position Count Settings** of the axis specified by *Axis* (Axis), *Status* (Servo ON) changes to TRUE with *MC\_Power* (Power Servo), and the home is determined.
- For either the axis specified by *Axis* (Axis) or the master axis synchronized in cam motion, the *MC\_ChangeAxisUse* (Change Axis Use) instruction is executed.
- Any of the following cases applies to either the axis specified by *Axis* (Axis) or the master axis synchronized in cam operation.
  - a) EtherCAT process data communications are not established.
  - b) An EtherCAT Slave Communications Error (84400000 hex) occurs.
  - c) The slave is disconnected.
- After the phase reaches *EndOfProfile* (End of Cam Cycle) at the completion of the cam operation, *Valid* does not change to TRUE even when the phase enters the cam profile curve again.
- The operating mode of the CPU Unit changes from RUN mode to PROGRAM mode.
- MC Test Run is started.

# MC\_GearIn

Specifies the gear ratio between the master axis and the slave axis and starts gear operation.

Instruction	Name	FB/ FUN	Graphic expression	ST expression
MC_GearIn	Start Gear Operation	FB		<pre>MC_GearIn_instance (   Master :=parameter,   Slave :=parameter,   Execute :=parameter,   RatioNumerator :=parameter,   RatioDenominator :=parameter,   ReferenceType :=parameter,   Acceleration :=parameter,   Deceleration :=parameter,   Jerk :=parameter,   BufferMode :=parameter,   InGear =&gt;parameter,   Busy =&gt;parameter,   Active =&gt;parameter,   CommandAborted =&gt;parameter,   Error =&gt;parameter,   ErrorID =&gt;parameter );</pre>

## Variables

### Input Variables

Name	Meaning	Data type	Valid range	De- fault	Description
Execute	Execute	BOOL	TRUE or FALSE	FALSE	The instruction is executed when the value of this variable changes to TRUE.
RatioNumerato- r	Gear Ratio Numerator	DINT*1	Positive or negative number*1	10,000	Specify the numerator of the electronic gear ratio between the master and slave axes.
RatioDenomina- tor	Gear Ratio Denominator	UDINT*2	Positive number	10,000	Specify the denominator of the electronic gear ratio between the master and slave axes.
Reference- Type*3	Position Type Selection	_eMC_REFERENCE_TYPE	0: _mcCommand 1: _mcFeedback 2: _mcLatestCommand	0*4	Specify the position type. 0: Command position (value calculated in the previous task period*5) 1: Actual position (value obtained in the same task period*5) 2: Command position (value calculated in the same task period*5)
Acceleration	Acceleration Rate	LREAL	Non-negative number	0	Specify the acceleration rate. The unit is command units/s <sup>2</sup> . *6

Name	Meaning	Data type	Valid range	Default	Description
Deceleration	Deceleration Rate	LREAL	Non-negative number	0	Specify the deceleration rate. The unit is command units/s <sup>2</sup> . *6
Jerk (Reserved)	Jerk	LREAL	0	0	(Reserved)
BufferMode	Buffer Mode Selection	_eMC_BUFFER_MODE	0: _mcAborting 1: _mcBuffered	0*4	Specify the behavior when executing more than one motion instruction. 0: Aborting 1: Buffered

- \*1. A CPU Unit with unit version 1.02 or later and Sysmac Studio version 1.03 or higher are required to use this variable. For any previous version combinations, the data type is UINT and the valid range is positive numbers.
- \*2. A CPU Unit with unit version 1.02 or later and Sysmac Studio version 1.03 or higher are required to use this variable. For any previous version combinations, the data type is UINT.
- \*3. To use `_mcLatestCommand`, the following condition must be met for the master and slave axes. When you use this variable, the axis number set for the *Master* (Master Axis) in the system-defined variable for motion control must be lower than the axis number set for the *Slave* (Slave Axis) in the system-defined variable for motion control.
- \*4. The default value for an enumeration variable is actually not the number, but the enumerator.
- \*5. The task period is the primary period if the task is the primary periodic task and the task period of the priority-5 periodic task if the task is the priority-5 periodic task.
- \*6. Refer to *Unit Conversion Settings* in the *NJ/NX-series CPU Unit Motion Control User's Manual (Cat. No. W507)* for information on command units.

## Output Variables

Name	Meaning	Data type	Valid range	Description
InGear	Gear Ratio Achieved	BOOL	TRUE or FALSE	TRUE when the slave axis reaches the target velocity.
Busy	Executing	BOOL	TRUE or FALSE	TRUE when the instruction is acknowledged.
Active	Controlling	BOOL	TRUE or FALSE	TRUE when the axis is being controlled.
CommandAborted	Command Aborted	BOOL	TRUE or FALSE	TRUE when the instruction is aborted.
Error	Error	BOOL	TRUE or FALSE	TRUE while there is an error.
ErrorID	Error Code	WORD	*1	Contains the error code when an error occurs. A value of 16#0000 indicates normal execution.

- \*1. The upper four digits of the event code give the error code for ErrorID. Refer to the *NJ/NX-series Troubleshooting Manual (Cat. No. W503)* for the event codes.

### ● Output Variable Update Timing

Name	Timing for changing to TRUE	Timing for changing to FALSE
InGear	When the following relationship is established. <ul style="list-style-type: none"> <li>Accelerating: Velocity of slave axis <math>\geq</math> Velocity of master axis <math>\times</math> Gear ratio</li> <li>Decelerating: Velocity of slave axis <math>\leq</math> Velocity of master axis <math>\times</math> Gear ratio</li> </ul>	<ul style="list-style-type: none"> <li>When <i>Error</i> changes to TRUE.</li> <li>When <i>CommandAborted</i> changes to TRUE.</li> </ul>

Name	Timing for changing to TRUE	Timing for changing to FALSE
Busy	When <i>Execute</i> changes to TRUE.	<ul style="list-style-type: none"> <li>When <i>Error</i> changes to TRUE.</li> <li>When <i>CommandAborted</i> changes to TRUE.</li> </ul>
Active	When the instruction is started.	<ul style="list-style-type: none"> <li>When <i>Error</i> changes to TRUE.</li> <li>When <i>CommandAborted</i> changes to TRUE.</li> </ul>
CommandAborted	<ul style="list-style-type: none"> <li>When this instruction is aborted because another motion control instruction was executed with the Buffer Mode set to <b>Aborting</b>.</li> <li>When this instruction is canceled due to an error.</li> <li>When this instruction is executed while there is an error.</li> <li>When you start this instruction during MC_Stop instruction execution.</li> <li>When the MC_GearOut instruction is executed.</li> </ul>	<ul style="list-style-type: none"> <li>When <i>Execute</i> is TRUE and changes to FALSE.</li> <li>After one period when <i>Execute</i> is FALSE.</li> </ul>
Error	When there is an error in the execution conditions or input parameters for the instruction.	When the error is cleared.

## In-Out Variables

Name	Meaning	Data type	Valid range	Description
Master	Master Axis	_sAXIS_REF	---	Specify the master axis. *1
Slave	Slave Axis	_sAXIS_REF	---	Specify the slave axis. *1

- \*1. Specify a user-defined Axis Variable that was created in the Axis Basic Settings of the Sysmac Studio (default: MC\_Axis\*) or a system-defined axis variable name (\_MC\_AX[\*], \_MC1\_AX[\*], or \_MC2\_AX[\*]).  
 If you use Sysmac Studio version 1.29 or higher, you can specify the system-defined axis variable name for AT specification of a user-defined variable. This will allow you to specify the user-defined variable.  
 If you use Sysmac Studio version 1.28 or lower, do not specify any user-defined variable created in the variable table.



### Precautions for Correct Use

If you specify the same axis for the master axis and slave axis, a Master and Slave Defined as Same Axis minor fault (error code 5436 hex) will occur.

## Function

- The MC\_GearIn instruction performs gear operation for the slave axis specified with *Slave* (Slave Axis). The following parameters are also specified: *RatioNumerator* (Gear Ratio Numerator), *RatioDenominator* (Gear Ratio Denominator), *ReferenceType* (Position Type), *Acceleration* (Acceleration Rate), and *Deceleration* (Deceleration Rate).
- For *Master* (Master Axis), you can specify the command position, actual position, or most recent command position.



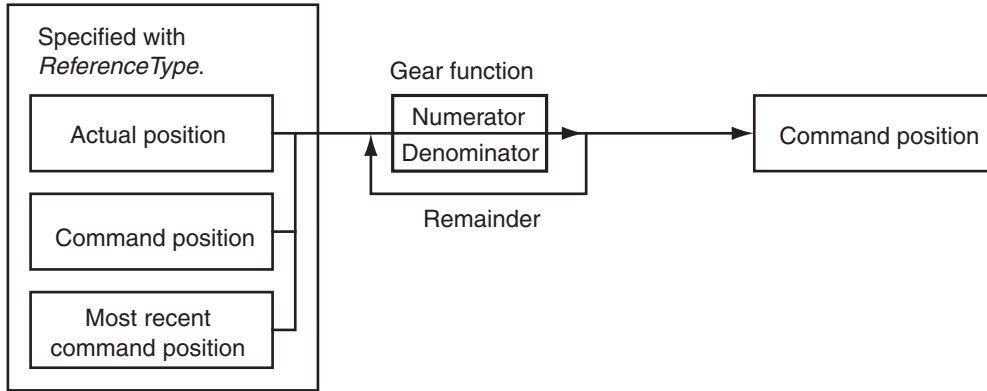

- After operation starts, *Slave* (Slave Axis) uses the velocity of *Master* (Master Axis) multiplied by the gear ratio for its target velocity, and accelerates/decelerates accordingly.
- The catching phase exists until the target velocity is reached. The InGear phase exists after that.
- If the gear ratio is positive, *Slave* (Slave Axis) and *Master* (Master Axis) move in the same direction.

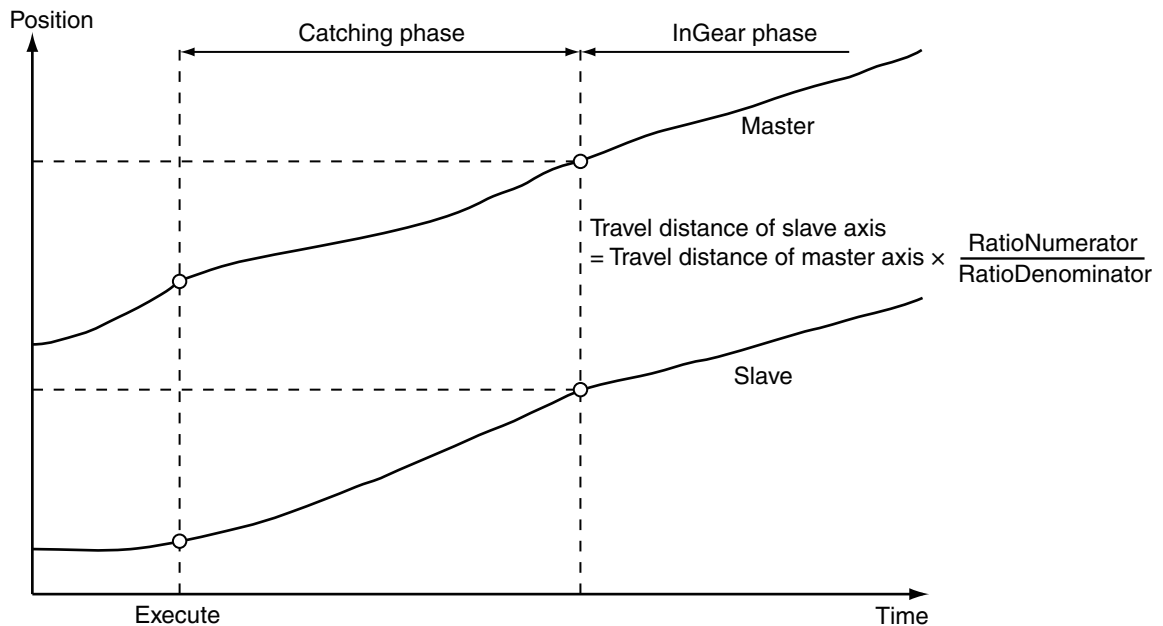

- If the gear ratio is negative, *Slave* (Slave Axis) and *Master* (Master Axis) move in the opposite directions.

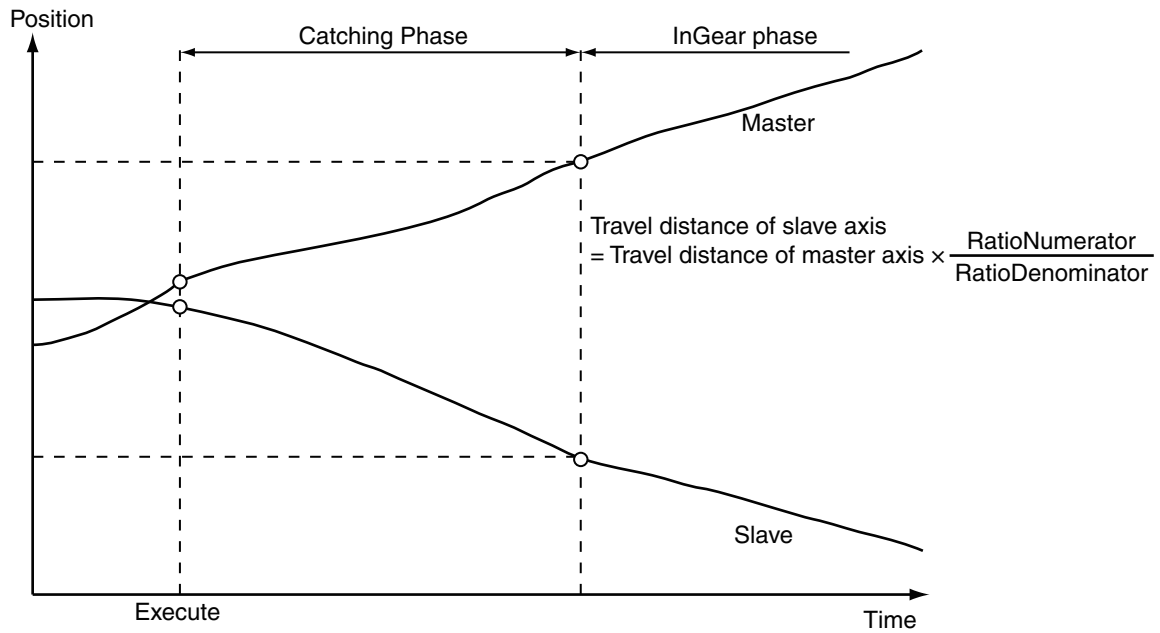

- Electronic gear operation starts when *Execute* changes to TRUE.



#### Precautions for Correct Use

Do not execute the MC\_SetPosition instruction for the *Master* (Master Axis) if you use this instruction on a CPU Unit with unit version 1.09 or earlier. If the MC\_SetPosition instruction is executed for the *Master* (Master Axis), the *Slave* (Slave Axis) may follow the master axis quickly.

If you want to use the MC\_SetPosition instruction for the *Master* (Master Axis), disable the relationship between the *Master* (Master Axis) and *Slave* (Slave Axis) before executing the instruction.

Refer to 1-1-3 *Precautions for Master and Auxiliary Axes in Synchronized Control* on page 1-6 for precautions on the master axis.

#### ● ReferenceType (Position Type Selection)

You can select one of the following position types.

- `_mcCommand`: Command position (value calculated in the previous task period)  
The master axis command position that was calculated in the previous task period is used for the current period.  
The command value that was calculated for the master axis in the last periodic task is used to calculate the command position of the slave axis in the current period.
- `_mcFeedback`: Value obtained in the same task period  
The actual position of the master axis that was obtained in the same task period is used.
- `_mcLatestCommand`: Command position (value calculated in the same task period)  
The command position of the master axis that was calculated in the same task period is used. This enables the use of information that is more recent than for `_mcCommand`. However, the axis number of the master axis must be set lower than the axis number of the slave axis. If the axis number of the slave axis is lower than the axis number of the master axis, *Error* will change to TRUE. A Master/Slave Axis Numbers Not in Ascending Order error (error code: 5438 hex) will be output to *ErrorID*.



### Precautions for Correct Use

Here, the task period is the primary period if the task is the primary periodic task and the task period of the priority-5 periodic task if the task is the priority-5 periodic task. In the same way, the periodic task is the primary periodic task or the priority-5 periodic task.



### Additional Information

The command position that is calculated in the same task period enables greater precision in synchronization than the command position that was calculated in the previous task period. However, the axis number set for the *Master* (Master Axis) in the system-defined variable for motion control must be lower than the axis number set for the *Slave* (Slave Axis) in the system-defined variable for motion control.

## ● Relationship between Axis Types and Position Types

The relationship between the axis types that you can monitor and position types that is monitored is shown below.

Axis Type	ReferenceType	
	_mcCommand or _mcLatestCommand	_mcFeedback
Servo axis	OK	OK
Encoder axis	No *1	OK
Virtual servo axis	OK	OK
Virtual encoder axis	No *1	OK

\*1. A Position Type Selection Out of Range error (error code: 5430 hex) occurs when the instruction is executed.

## Timing Charts

- *Busy* (Executing) changes to TRUE at the same time as *Execute* changes to TRUE. *Active* (Controlling) changes to TRUE in the next period.
- *InGear* (Gear Ratio Reached) changes to TRUE when the target velocity is reached.
- If another instruction aborts this instruction, *CommandAborted* changes to TRUE and *Busy* (Executing), *Active* (Controlling), and *InGear* (Gear Ratio Reached) change to FALSE.
- Use the MC\_GearOut (End Gear Operation) or MC\_Stop instruction to stop electronic gear operation before it is completed.

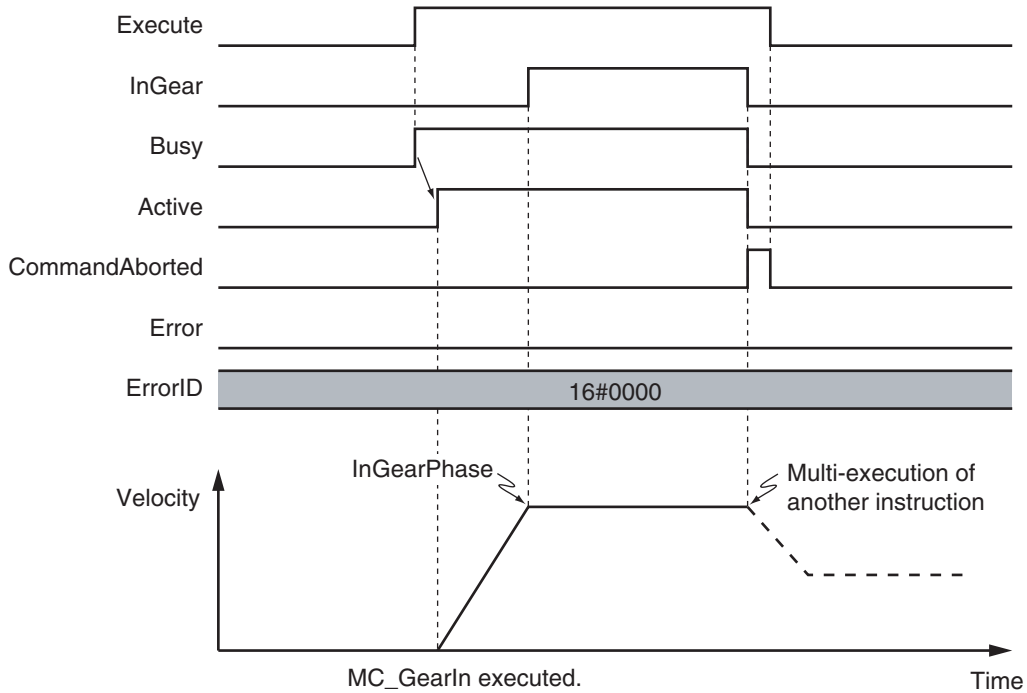

You can specify the *Acceleration* (Acceleration Rate) and *Deceleration* (Deceleration Rate) as input variables.

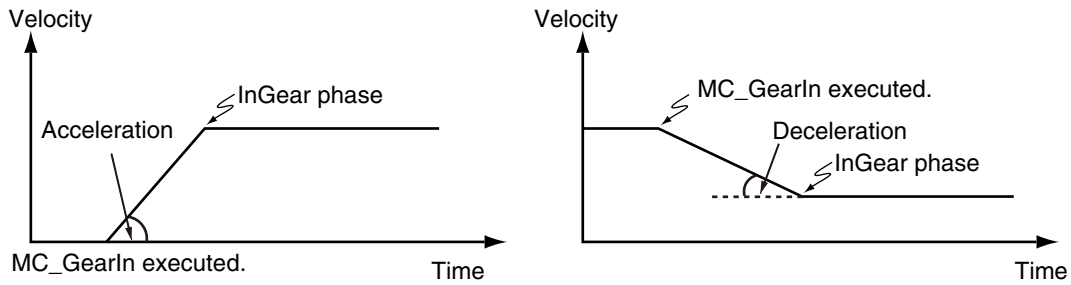

When the *Acceleration* (Acceleration Rate) or *Deceleration* (Deceleration Rate) is 0 and you execute this instruction, the axis will reach the target velocity without accelerating or decelerating.

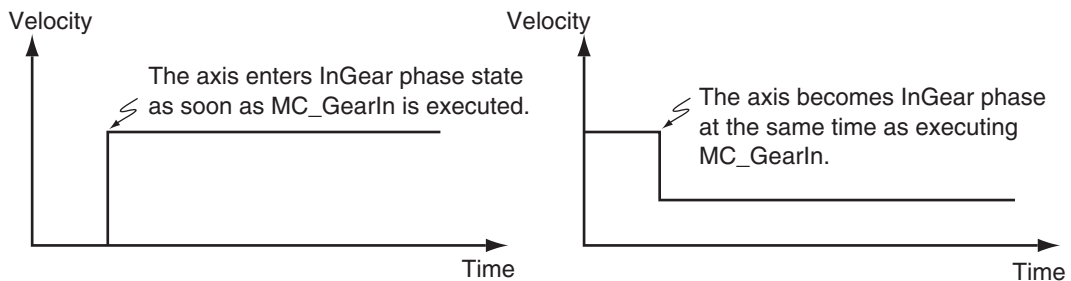

## Re-execution of Motion Control Instructions

You can change the operation of the instruction if you change an input variable during positioning and change *Execute* to TRUE again.

Input variables *RatioNumerator* (Gear Ratio Numerator), *RatioDenominator* (Gear Ratio Denominator), *Acceleration* (Acceleration Rate), and *Deceleration* (Deceleration Rate) can be changed by re-executing the motion control instruction.

For details on re-execution of motion control instructions, refer to the *NJ/NX-series CPU Unit Motion Control User's Manual (Cat. No. W507)*.

The following timing chart shows when the instruction is re-executed during the Catching phase to change the *Acceleration* (Acceleration Rate).

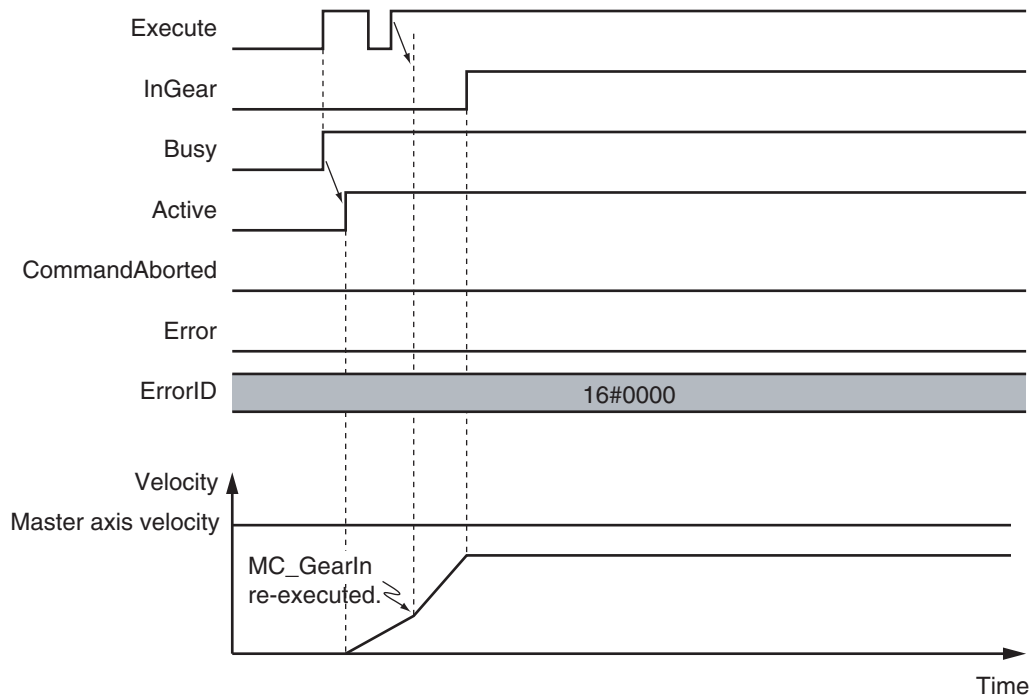

The following timing chart shows when the instruction is re-executed during the InGear phase to change the *RatioNumerator* (Gear Ratio Numerator) and *RatioDenominator* (Gear Ratio Denominator).

The motion is the same as when *Acceleration* (Acceleration Rate) and *Deceleration* (Deceleration Rate) are both set to 0.

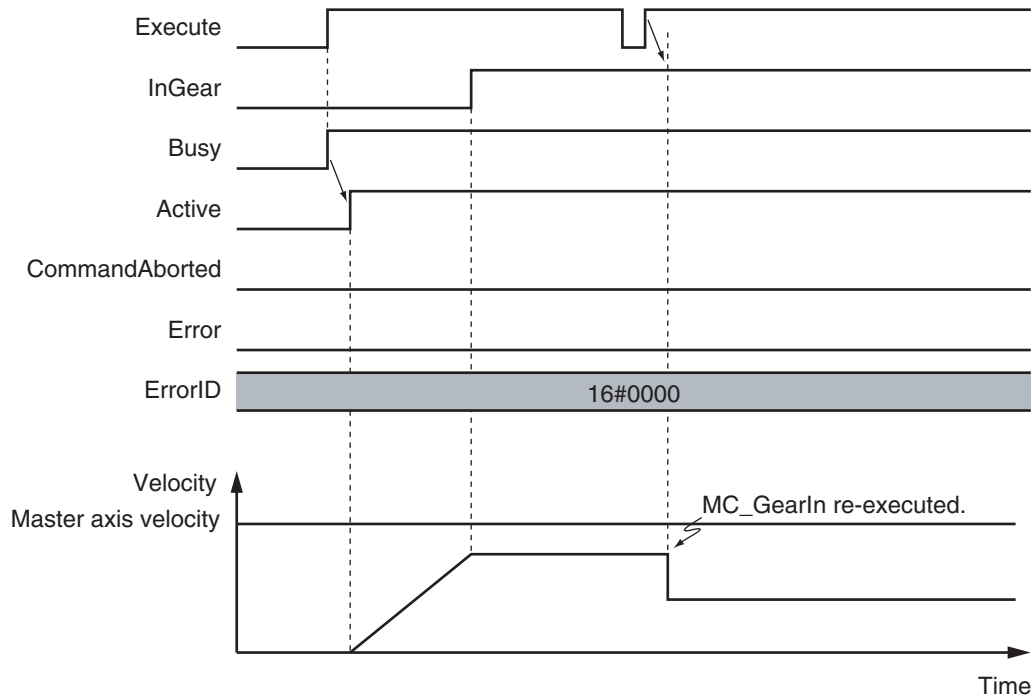

## Multi-execution of Motion Control Instructions

For details on multi-execution of motion control instructions, refer to the *NJ/NX-series CPU Unit Motion Control User's Manual (Cat. No. W507)*.

### ● Execution during Execution of Other Instructions

You can switch to this instruction or buffer this instruction if you execute it during execution of another instruction.

You can buffer one instruction per axis.

Specify the operation of this instruction using *BufferMode* (Buffer Mode Selection) for multi-execution of instructions.

Buffer Mode Selection	Description
Aborting	Aborts the instruction being executed and switches to this instruction. If the direction of axis motion is reversed by switching instructions, the motion will be reversed according to the <b>Operation Selection at Reversing</b> axis parameter.
Buffered	Buffers this instruction and executes it automatically after the current instruction is completed.

For details on *BufferMode* (Buffer Mode Selection), refer to the *NJ/NX-series CPU Unit Motion Control User's Manual (Cat. No. W507)*.

### ● Execution of Other Instructions during Instruction Execution

Another instruction with the Buffer Mode set to **Aborting** can be executed during execution of this instruction.

In that case, the gear operation is stopped and the operation of the aborting instruction is started.

You cannot specify any Buffer Mode with other than **Aborting**.

## Errors

If an error occurs during instruction execution, *Error* will change to TRUE.

You can find out the cause of the error by referring to the value output by *ErrorID* (Error Code).

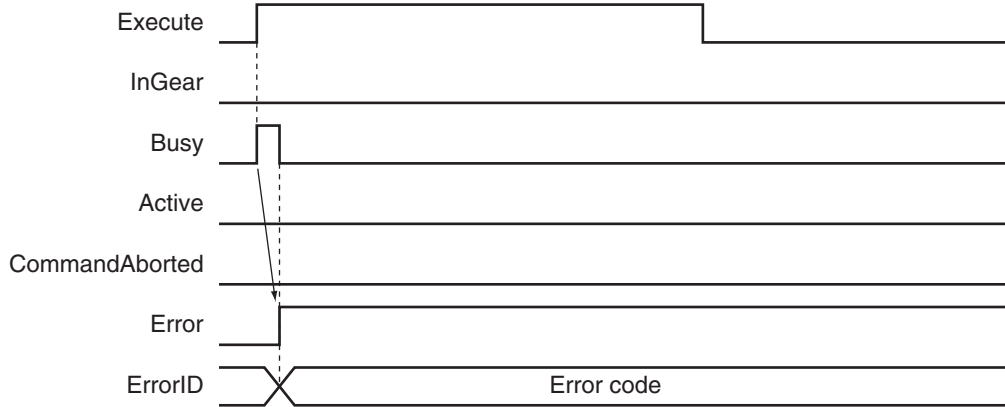

### Additional Information

- The slave axis is not affected by the error status of the master axis during synchronized control. The error status of the master axis is cleared and the slave axis continues electronic gear operation after the master axis operates normally.
- The master axis is not affected if an error occurs for the slave axis during startup or execution of this instruction.

## ● Error Codes

Refer to the *NJ/NX-series Troubleshooting Manual (Cat. No. W503)* for instruction errors.

## Sample Programming

This section shows sample programming for operation proportional to a gear ratio.



### Additional Information

You can specify only the initial values for input variables that are reserved. Parameters are not specified in this sample.

## Parameter Settings

The minimum settings required for this sample programming are given below.

## ● Setting Axis Parameters

### Axis Types

Axis	Axis Type
Axis 1	Servo axis (master axis)
Axis 2	Servo axis (slave axis)
Axis 3	Servo axis (slave axis)

**Count Modes**

Axis	Count Mode
Axis 1	Rotary Mode
Axis 2	Rotary Mode
Axis 3	Rotary Mode

**Ring Counter**

Axis	Modulo maximum position	Modulo minimum position
Axis 1	360	0
Axis 2	360	0
Axis 3	360	0

**Units of Display**

Axis	Unit of Display
Axis 1	mm
Axis 2	mm
Axis 3	mm

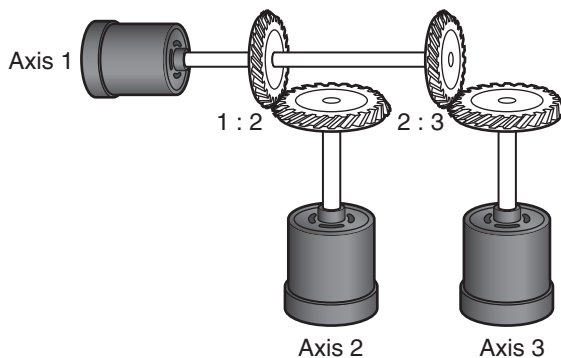
**Operation Example**

- 1** Starting the Master Axis  
The master axis (axis 1) is an actual servo axis and it is operated with velocity control.
- 2** Executing the Slave Axes  
When the actual velocity for the master axis reaches the target velocity, gear operation is performed so that the gear ratio of axis 2 (slave axis) is 1:2 and axis 3 (slave axis) is 2:3 against the actual position of the master axis.
- 3** Stopping the Slave Axes  
When the actual position of the master axis *MC\_Axis000.Act.Pos* exceeds 1000.0, gear operation of axis 2 is ended and axis 2 decelerates to a stop with deceleration rate *DecRate*. Axis 3 continues gear operation.



## Ladder Diagram

### ● Main Variables

Name	Data type	Default	Comment
MC_Axis000	_sAXIS_REF	---	Axis Variable for the master axis, axis 1.
MC_Axis000.Act.Pos	LREAL	---	This variable gives the actual current position of axis 1.
MC_Axis001	_sAXIS_REF	---	Axis Variable for the slave axis, axis 2.
MC_Axis002	_sAXIS_REF	---	Axis Variable for the slave axis, axis 3.
Pwr1_Status	BOOL	FALSE	This variable is assigned to the <i>Status</i> output variable from the PWR1 instance of the MC_Power instruction. This variable changes to TRUE when the Servo is turned ON.
Pwr2_Status	BOOL	FALSE	This variable is assigned to the <i>Status</i> output variable from the PWR2 instance of the MC_Power instruction. This variable changes to TRUE when the Servo is turned ON.
Pwr3_Status	BOOL	FALSE	This variable is assigned to the <i>Status</i> output variable from the PWR3 instance of the MC_Power instruction. This variable changes to TRUE when the Servo is turned ON.
StartPg	BOOL	FALSE	The Servo is turned ON if this variable is TRUE and EtherCAT process data communications are established.
Vel_InVel	BOOL	FALSE	This variable is assigned to the <i>InVelocity</i> output variable from the VEL instance of the MC_MoveVelocity instruction. It is TRUE when the target velocity is reached.
Gearin1_Act	BOOL	FALSE	This variable is assigned to the <i>Active</i> output variable from the GEARIN1 instance of the MC_GearIn instruction. It is TRUE during control operations for GEARIN1.
Gearout_Ex	BOOL	FALSE	The GEAROUT instance of MC_GearOut is executed when this variable changes to TRUE.

● **Timing Chart**

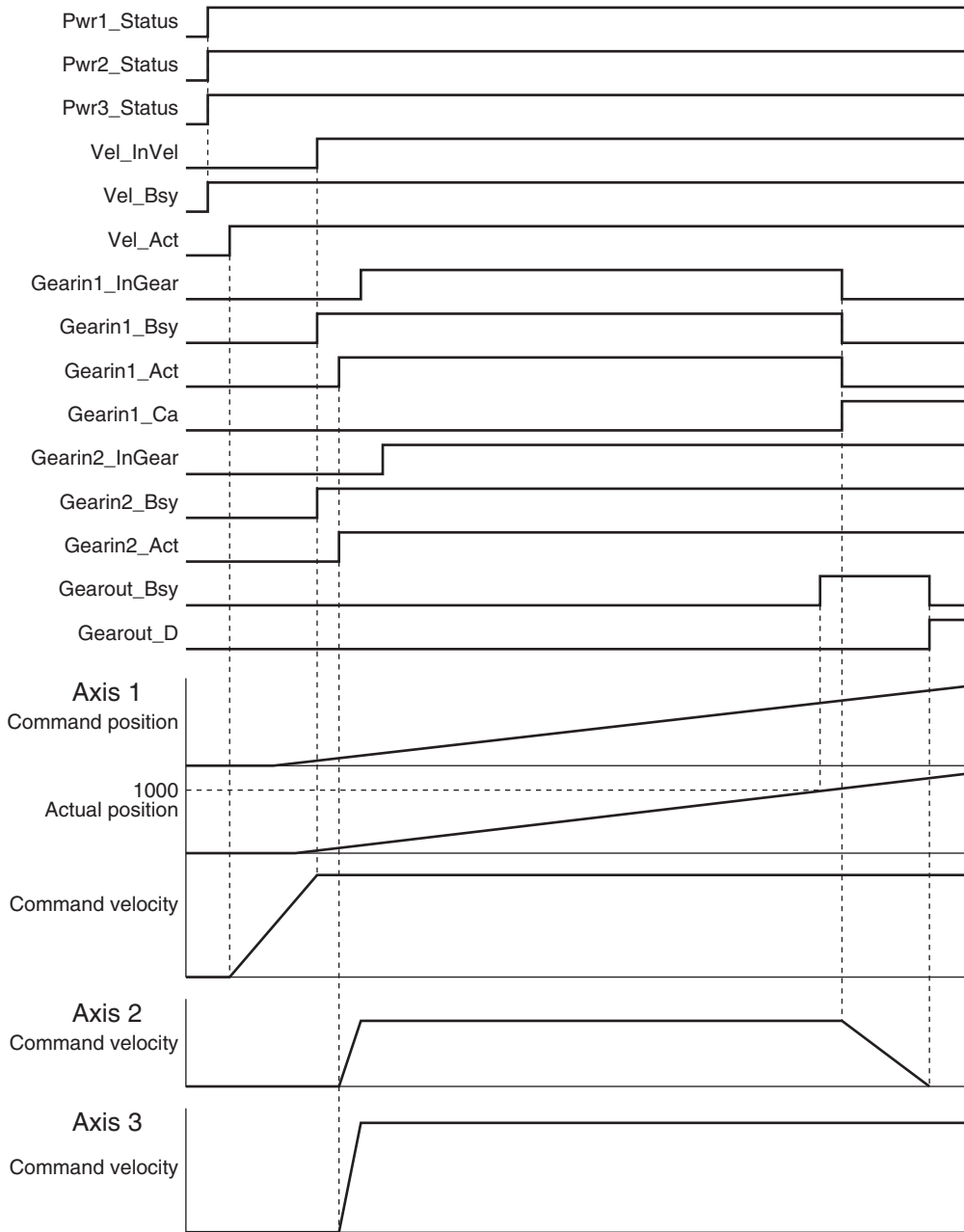

● **Sample Programming**

If *StartPg* is TRUE, check that the Servo Drives for each axis are ready.

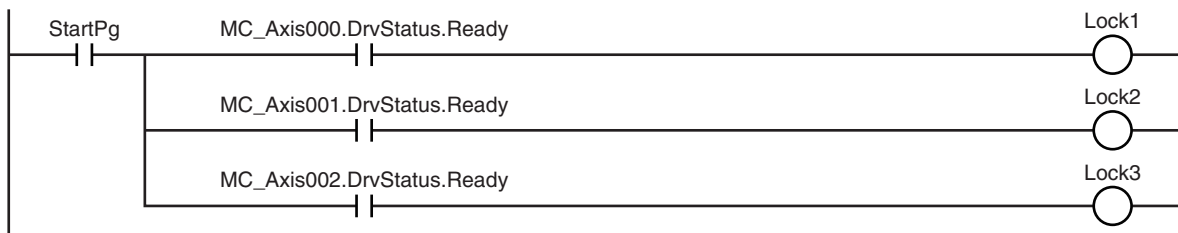

If the Servo Drives are ready, the Servos are turned ON for each axis.

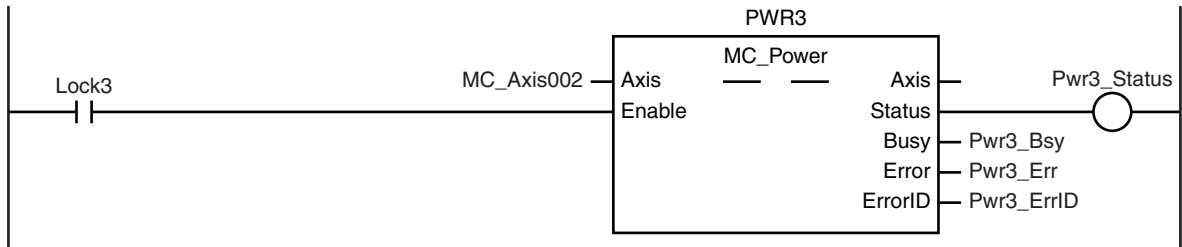
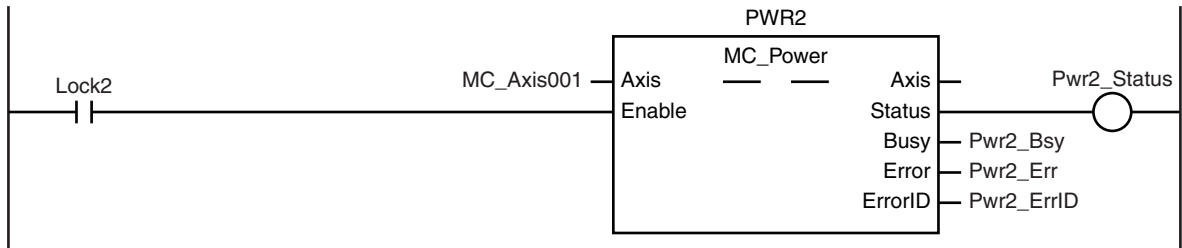
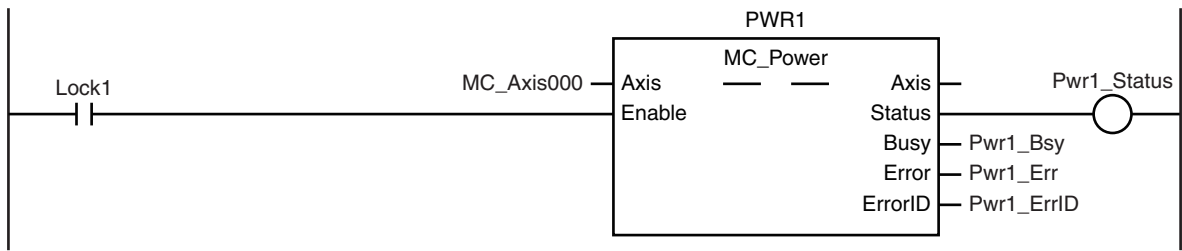

If a minor fault level error occurs for the axis composition, the error handler for the device (FaultHandler) is executed.

Program the FaultHandler according to the device.

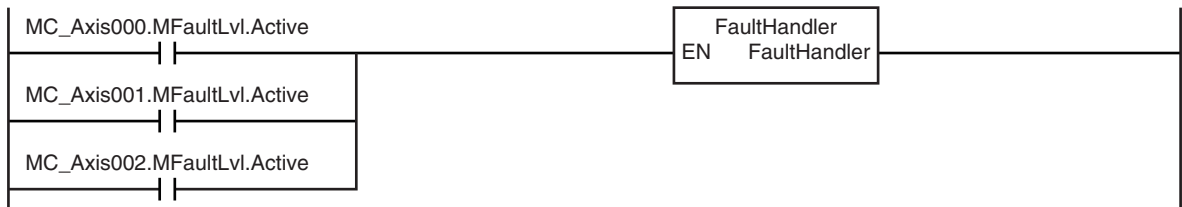

The MC\_MoveVelocity (Velocity Control) instruction is executed after the Servo is turned ON for the master axis (axis 1).

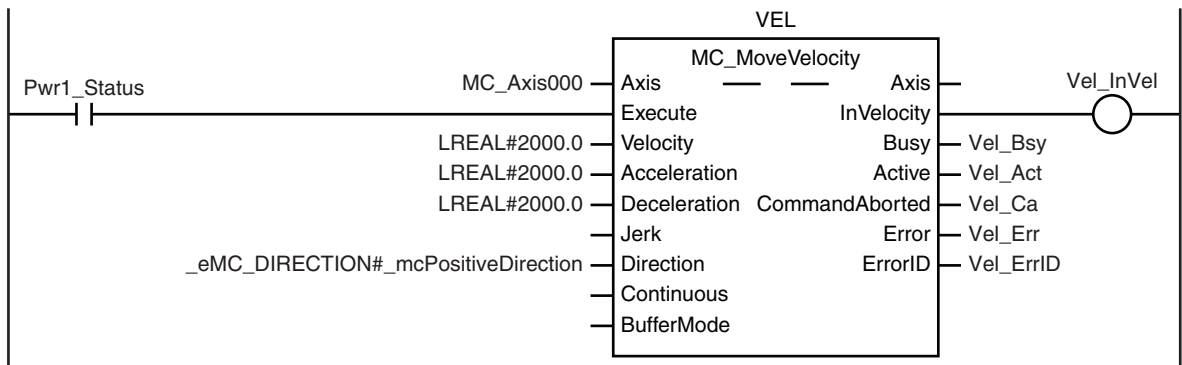

When the actual velocity for the master axis (axis 1) reaches the target velocity, gear operation is performed so that the gear ratio of axis 2 (slave axis) is 1:2 and axis 3 (slave axis) is 2:3.

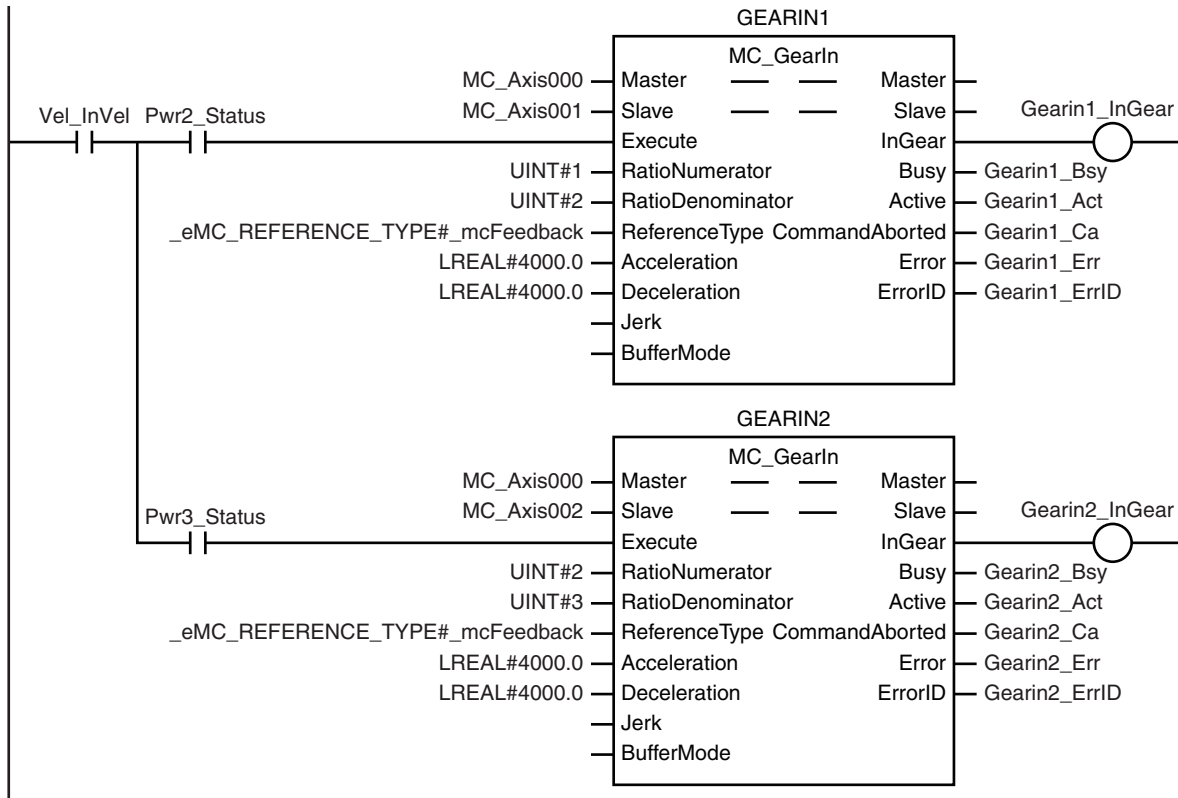

When the actual position of the master axis is 1000.0 or higher during gear operation of axis 2 (slave axis), `Gearout_Ex` changes to TRUE.

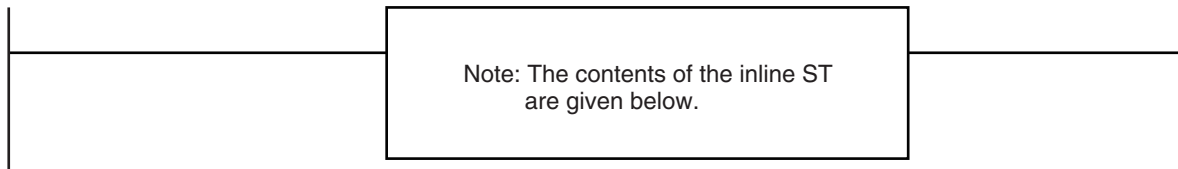

When `Gearout_Ex` changes to TRUE, gear operation is stopped for the axis 2 (slave axis). The axis decelerates to a stop.

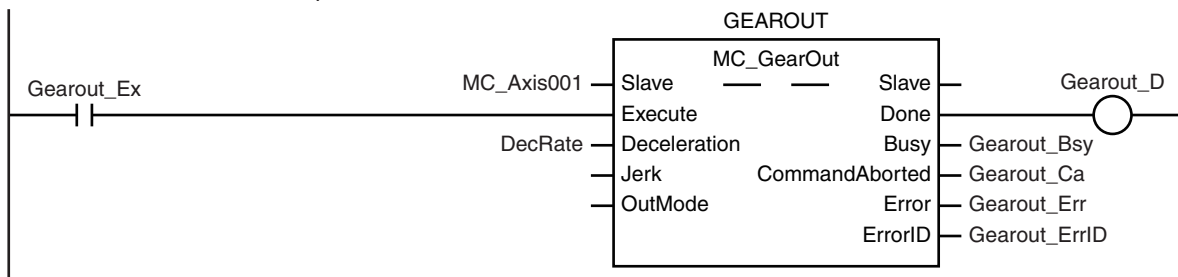

#### Contents of Inline ST

```
IF (Gearin1_Act=TRUE) AND (MC_Axis000.Act.Pos>=LREAL#1000.0) THEN
    Gearout_Ex := TRUE;
END_IF;
```

## Structured Text (ST)

### ● Main Variables

Name	Data type	Default	Comment
MC_Axis000	_sAXIS_REF	---	Axis Variable for the master axis, axis 1.
MC_Axis000.Act.Pos	LREAL	---	This variable gives the actual current position of axis 1.
MC_Axis001	_sAXIS_REF	---	Axis Variable for the slave axis, axis 2.
MC_Axis002	_sAXIS_REF	---	Axis Variable for the slave axis, axis 3.
Pwr1_Status	BOOL	FALSE	This variable is assigned to the <i>Status</i> output variable from the PWR1 instance of the MC_Power instruction. This variable changes to TRUE when the Servo is turned ON.
Pwr2_Status	BOOL	FALSE	This variable is assigned to the <i>Status</i> output variable from the PWR2 instance of the MC_Power instruction. This variable changes to TRUE when the Servo is turned ON.
Pwr3_Status	BOOL	FALSE	This variable is assigned to the <i>Status</i> output variable from the PWR3 instance of the MC_Power instruction. This variable changes to TRUE when the Servo is turned ON.
StartPg	BOOL	FALSE	The Servo is turned ON if this variable is TRUE and EtherCAT process data communications are established.
Vel_InVel	BOOL	FALSE	This variable is assigned to the <i>InVelocity</i> output variable from the VEL instance of the MC_MoveVelocity instruction. It is TRUE when the target velocity is reached.
Gearin1_Act	BOOL	FALSE	This variable is assigned to the <i>Active</i> output variable from the GEARIN1 instance of the MC_GearIn instruction. It is TRUE during control operations for GEARIN1.
Gearout_Ex	BOOL	FALSE	The GEAROUT instance of MC_GearOut is executed when this variable changes to TRUE.
Vel_Ex	BOOL	FALSE	The VEL instance of MC_MoveVelocity is executed when this variable changes to TRUE.
Gearin1_Ex	BOOL	FALSE	The GEARIN1 instance of MC_GearIn is executed when this variable changes to TRUE.
Gearin2_Ex	BOOL	FALSE	The GEARIN2 instance of MC_GearIn is executed when this variable changes to TRUE.
InitFlag	BOOL	FALSE	This variable indicates if it is necessary to set the input parameters. Input parameters are set when this variable is FALSE. When setting the input parameters is completed, this variable changes to TRUE.

● **Timing Chart**

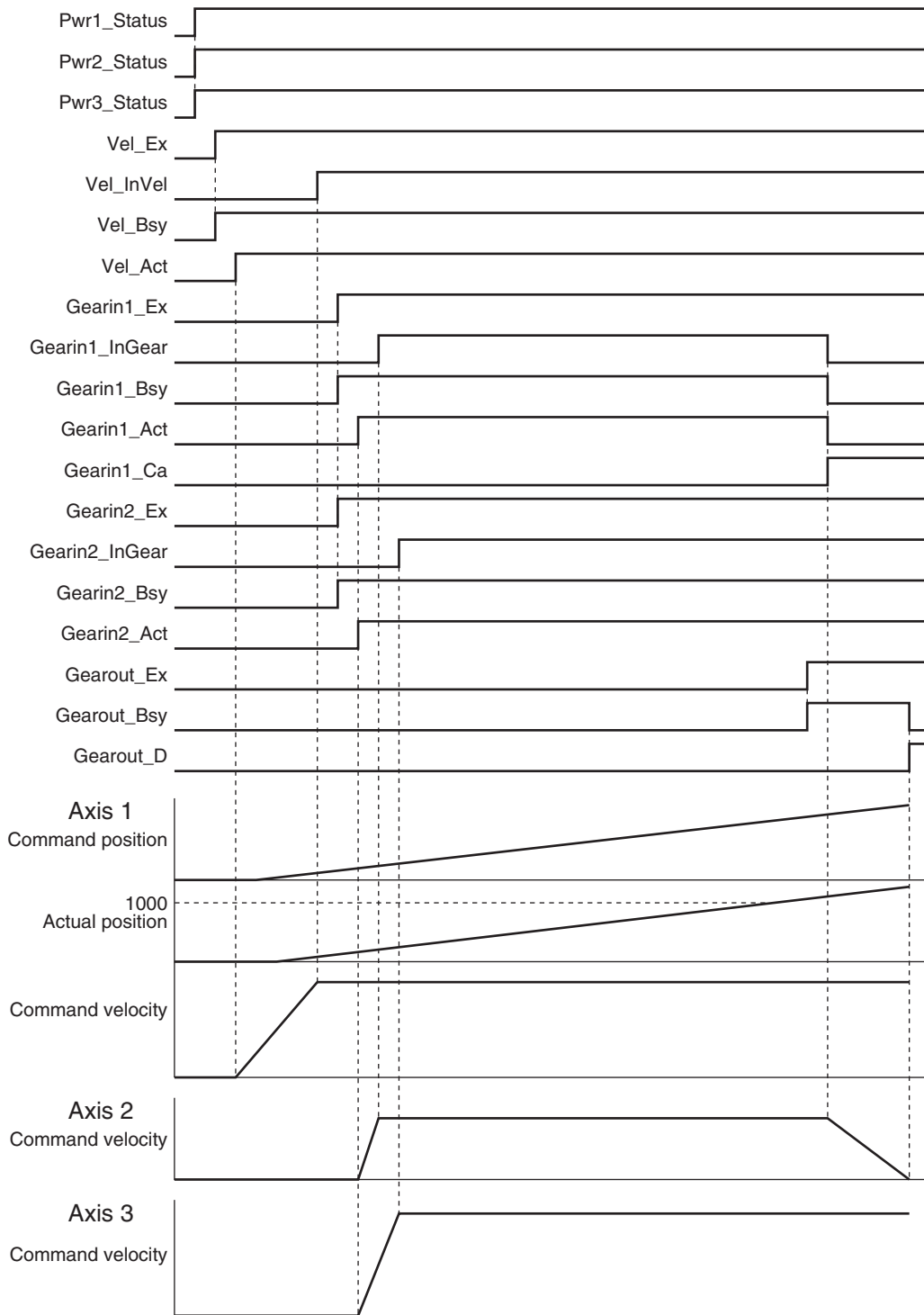

● **Sample Programming**

```
// Processing when input parameters are not set
IF InitFlag = FALSE THEN

    // MC_MoveVelocity parameters
    Vel_Vel := LREAL#2000.0;
    Vel_Acc := LREAL#2000.0;
```

```

Vel_Dec := LREAL#2000.0;
Vel_Dir :=_eMC_DIRECTION#_mcPositiveDirection;

// MC_GearIn1 parameters
Gearin1_Rn := UINT#1;
Gearin1_Rd := UINT#2;
Gearin1_Rt :=_eMC_REFERENCE_TYPE#_mcFeedback;
Gearin1_Acc := LREAL#4000.0;
Gearin1_Dec := LREAL#4000.0;

// MC_GearIn2 parameters
Gearin2_Rn := UINT#2;
Gearin2_Rd := UINT#3;
Gearin2_Rt :=_eMC_REFERENCE_TYPE#_mcFeedback;
Gearin2_Acc := LREAL#4000.0;
Gearin2_Dec := LREAL#4000.0;

// MC_GearOut parameters
DecRate := LREAL#200.0;
Gearout_Dec := DecRate;

// Change InitFlag to TRUE after setting the input parameters.
InitFlag:=TRUE;

END_IF;

// If StartPg is TRUE and the Servo Drive is ready, the Servo for axis 1 is turned
ON.
// If the Servo Drive is not ready, the Servo is turned OFF.
IF (StartPg=TRUE)
  AND (MC_Axis000.DrvStatus.Ready=TRUE) THEN
    Pwr1_En:=TRUE;
  ELSE
    Pwr1_En:=FALSE;
  END_IF;

// If StartPg is TRUE and the Servo Drive is ready, the Servo for axis 2 is turned
ON.
// If the Servo Drive is not ready, the Servo is turned OFF.
IF (StartPg=TRUE)
  AND (MC_Axis001.DrvStatus.Ready=TRUE) THEN
    Pwr2_En:=TRUE;
  ELSE
    Pwr2_En:=FALSE;
  END_IF;

// If StartPg is TRUE and the Servo Drive is ready, the Servo for axis 3 is turned

```

```

ON.
// If the Servo Drive is not ready, the Servo is turned OFF.
IF (StartPg=TRUE)
  AND (MC_Axis002.DrvStatus.Ready=TRUE) THEN
    Pwr3_En:=TRUE;
ELSE
    Pwr3_En:=FALSE;
END_IF;

// If a minor fault level error occurs for axis 1 to axis 3, the error handler for
the device (FaultHandler) is executed.
// Program the FaultHandler according to the device.
IF (MC_Axis000.MFaultLvl.Active=TRUE) OR (MC_Axis001.MFaultLvl.Active=TRUE)
  OR (MC_Axis002.MFaultLvl.Active=TRUE) THEN
    FaultHandler();
END_IF;

// If the Servo is ON for axis 1, the MC_MoveVelocity instruction is executed.
IF Pwr1_Status=TRUE THEN
    Vel_Ex := TRUE;
END_IF;

// If InVelocity of MC_MoveVelocity is TRUE and the Servo for axis 2 is ON, MC_Gear
In is executed with axis 1 as the master axis and axis 2 as the slave axis.
IF (Vel_InVel=TRUE) AND (Pwr2_Status=TRUE) THEN
    Gearin1_Ex := TRUE;
END_IF;

// If InVelocity of MC_MoveVelocity is TRUE and the Servo for axis 3 is ON, MC_Gear
In is executed with axis 1 as the master axis and axis 3 as the slave axis.
IF (Vel_InVel=TRUE) AND (Pwr3_Status=TRUE) THEN
    Gearin2_Ex := TRUE;
END_IF;

// If the actual position of axis 1 is 1000.0 or higher during gear operation for a
xis 2, the GearOut instruction for axis 2 (slave axis) is executed.
IF (Gearin1_Act=TRUE) AND (MC_Axis000.Act.Pos>=LREAL#1000.0) THEN
    Gearout_Ex := TRUE;
END_IF;

// MC_Power for axis 1
PWR1(
  Axis := MC_Axis000,
  Enable := Pwr1_En,
  Status => Pwr1_Status,
  Busy => Pwr1_Bsy,
  Error => Pwr1_Err,

```



```

        ErrorID => Pwr1_ErrID
    );

// MC_Power for axis 2
PWR2 (
    Axis := MC_Axis001,
    Enable := Pwr2_En,
    Status => Pwr2_Status,
    Busy => Pwr2_Bsy,
    Error => Pwr2_Err,
    ErrorID => Pwr2_ErrID
);

// MC_Power for axis 3
PWR3 (
    Axis := MC_Axis002,
    Enable := Pwr3_En,
    Status => Pwr3_Status,
    Busy => Pwr3_Bsy,
    Error => Pwr3_Err,
    ErrorID => Pwr3_ErrID
);

// MC_MoveVelocity
VEL (
    Axis := MC_Axis000,
    Execute := Vel_Ex,
    Velocity := Vel_Vel,
    Acceleration := Vel_Acc,
    Deceleration := Vel_Dec,
    Direction := Vel_Dir,
    InVelocity => Vel_InVel,
    Busy => Vel_Bsy,
    Active => Vel_Act,
    CommandAborted => Vel_Ca,
    Error => Vel_Err,
    ErrorID => Vel_ErrID
);

// MC_GearIn with axis 1 as master axis and axis 2 as slave axis
GEARIN1 (
    Master := MC_Axis000,
    Slave := MC_Axis001,
    Execute := Gearin1_Ex,
    RatioNumerator := Gearin1_Rn,
    RatioDenominator := Gearin1_Rd,
    ReferenceType := Gearin1_Rt,

```

```
Acceleration := Gearin1_Acc,
Deceleration := Gearin1_Dec,
InGear => Gearin1_InGear,
Busy => Gearin1_Bsy,
Active => Gearin1_Act,
CommandAborted => Gearin1_CA,
Error => Gearin1_Err,
ErrorID => Gearin1_ErrID
);

// MC_GearIn with axis 1 as master axis and axis 3 as slave axis
GEARIN2(
    Master := MC_Axis000,
    Slave := MC_Axis002,
    Execute := Gearin2_Ex,
    RatioNumerator := Gearin2_Rn,
    RatioDenominator := Gearin2_Rd,
    ReferenceType := Gearin2_Rt,
    Acceleration := Gearin2_Acc,
    Deceleration := Gearin2_Dec,
    InGear => Gearin2_InGear,
    Busy => Gearin2_Bsy,
    Active => Gearin2_Act,
    CommandAborted => Gearin2_CA,
    Error => Gearin2_Err,
    ErrorID => Gearin2_ErrID
);

// MC_GearOut
GEAROUT(
    Slave := MC_Axis001,
    Execute := Gearout_Ex,
    Deceleration := Gearout_Dec,
    Done => Gearout_D,
    Busy => Gearout_Bsy,
    CommandAborted => Gearout_CA,
    Error => Gearout_Err,
    ErrorID => Gearout_ErrID
);
```

# MC\_GearInPos

The MC\_GearInPos instruction performs electronic gear operation for the specified gear ratio between the master axis and the slave axis.

The positions at which to start synchronizing the master axis and slave axis are specified.

Instruction	Name	FB/ FUN	Graphic expression	ST expression
MC_GearInPos	Positioning Gear Opera- tion	FB		<pre>MC_GearInPos_instance (   Master :=parameter,   Slave :=parameter,   Execute :=parameter,   RatioNumerator :=parameter,   RatioDenominator :=parameter,   ReferenceType :=parameter,   MasterSyncPosition :=parameter,   SlaveSyncPosition :=parameter,   Velocity :=parameter,   Acceleration :=parameter,   Deceleration :=parameter,   Jerk :=parameter,   BufferMode :=parameter,   StartSync =&gt;parameter,   InSync =&gt;parameter,   Busy =&gt;parameter,   Active =&gt;parameter,   CommandAborted =&gt;parameter,   Error =&gt;parameter,   ErrorID =&gt;parameter );</pre>

## Variables

### Input Variables

Name	Meaning	Data type	Valid range	De- fault	Description
Execute	Execute	BOOL	TRUE or FALSE	FALSE	The instruction is executed when this variable changes to TRUE.
RatioNumerato- r	Gear Ratio Numerator	DINT *1	Positive or negative num- ber *1	10,000	Specify the numerator of the elec- tronic gear ratio between the mas- ter and slave axes.
RatioDenomi- nator	Gear Ratio Denomina- tor	UDINT *2	Positive number	10,000	Specify the denominator of the electronic gear ratio between the master and slave axes.

Name	Meaning	Data type	Valid range	Default	Description
ReferenceType *3	Position Type Selection	_eMC_REFERENCE_TYPE	0: _mcCommand 1: _mcFeedback 2: _mcLatestCommand	0 *4	Specify the position type. 0: Command position (value calculated in the previous task period*5) 1: Actual position (value obtained in the same task period*5) 2: Command position (value calculated in the same task period*5)
MasterSync Position	Master Sync Position	LREAL	Negative number, positive number, or 0	0	Specify the absolute master sync position. The unit is command units. *6
SlaveSyncPosition	Slave Sync Position	LREAL	Negative number, positive number, or 0	0	Specify the absolute slave sync position. The unit is command units. *6
Velocity	Target velocity	LREAL	Positive number	0	Specify the target velocity. Always set the target velocity. If the axis is moved without setting a target velocity, an error will occur. The unit is command units/s. *6
Acceleration	Acceleration Rate	LREAL	Non-negative number	0	Specify the acceleration rate. The unit is command units/s <sup>2</sup> . *6
Deceleration	Deceleration Rate	LREAL	Non-negative number	0	Specify the deceleration rate. The unit is command units/s <sup>2</sup> . *6
Jerk (Reserved)	Jerk	LREAL	0	0	(Reserved)
BufferMode (Reserved)	Buffer Mode Selection	_eMC_BUFFER_MODE	0: _mcAborting	0 *4	(Reserved)

- \*1. A CPU Unit with unit version 1.02 or later and Sysmac Studio 1.03 or higher are required to use this parameter. For any previous version combinations, the data type is UINT and the valid range is positive numbers.
- \*2. A CPU Unit with unit version 1.02 or later and Sysmac Studio 1.03 or higher are required to use this parameter. For any previous version combinations, the data type is UINT.
- \*3. To use \_mcLatestCommand, the following condition must be met for the master and slave axes.  
The axis number set for the *Master* (Master Axis) in the system-defined variable for motion control must be lower than the axis number set for *Slave* (Slave Axis) in the system-defined variable for motion control.
- \*4. The default value for an enumeration variable is actually not the number, but the enumerator.
- \*5. The task period is the primary period if the task is the primary periodic task and the task period of the priority-5 periodic task if the task is the priority-5 periodic task.
- \*6. Refer to *Unit Conversion Settings* in the *NJ/NX-series CPU Unit Motion Control User's Manual (Cat. No. W507)* for information on command units.

## Output Variables

Name	Meaning	Data type	Valid range	Description
StartSync	Following	BOOL	TRUE or FALSE	TRUE when acceleration/deceleration is started for synchronization.
InSync	In Sync	BOOL	TRUE or FALSE	TRUE when the slave axis reaches the slave sync position.

Name	Meaning	Data type	Valid range	Description
Busy	Executing	BOOL	TRUE or FALSE	TRUE when the instruction is acknowledged.
Active	Controlling	BOOL	TRUE or FALSE	TRUE while the axis is being controlled.
CommandAborted	Command Aborted	BOOL	TRUE or FALSE	TRUE when the instruction is aborted.
Error	Error	BOOL	TRUE or FALSE	TRUE while there is an error.
ErrorID	Error Code	WORD	*1	Contains the error code when an error occurs. A value of 16#0000 indicates normal execution.

\*1. The upper four digits of the event code give the error code for ErrorID. Refer to the *NJ/NX-series Troubleshooting Manual (Cat. No. W503)* for the event codes.

### ● Output Variable Update Timing

Name	Timing for changing to TRUE	Timing for changing to FALSE
StartSync	When the axis starts moving.	<ul style="list-style-type: none"> <li>When <i>Error</i> changes to TRUE.</li> <li>When <i>CommandAborted</i> changes to TRUE.</li> </ul>
InSync	When the slave axis reaches <i>SlaveSyncPosition</i> .	<ul style="list-style-type: none"> <li>When <i>Error</i> changes to TRUE.</li> <li>When <i>CommandAborted</i> changes to TRUE.</li> </ul>
Busy	When <i>Execute</i> changes to TRUE.	<ul style="list-style-type: none"> <li>When <i>Error</i> changes to TRUE.</li> <li>When <i>CommandAborted</i> changes to TRUE.</li> </ul>
Active	When an instruction is received.	<ul style="list-style-type: none"> <li>When <i>Error</i> changes to TRUE.</li> <li>When <i>CommandAborted</i> changes to TRUE.</li> </ul>
CommandAborted	<ul style="list-style-type: none"> <li>When this instruction is aborted because another motion control instruction was executed with the Buffer Mode set to <b>Aborting</b>.</li> <li>When this instruction is canceled due to an error.</li> <li>When this instruction is executed while there is an error.</li> <li>When you start this instruction during MC_Stop instruction execution.</li> <li>When the MC_GearOut instruction is executed.</li> </ul>	<ul style="list-style-type: none"> <li>When <i>Execute</i> is TRUE and changes to FALSE.</li> <li>After one period when <i>Execute</i> is FALSE.</li> </ul>
Error	When there is an error in the execution conditions or input parameters for the instruction.	When the error is cleared.

## In-Out Variables

Name	Meaning	Data type	Valid range	Description
Master	Master Axis	_sAXIS_REF	---	Specify the master axis. *1
Slave	Slave Axis	_sAXIS_REF	---	Specify the slave axis. *1

\*1. Specify a user-defined Axis Variable that was created in the Axis Basic Settings of the Sysmac Studio (default: MC\_Axis\*) or a system-defined axis variable name (\_MC\_AX[\*], \_MC1\_AX[\*], or \_MC2\_AX[\*]).  
If you use Sysmac Studio version 1.29 or higher, you can specify the system-defined axis variable name for AT specification of a user-defined variable. This will allow you to specify the user-defined variable.  
If you use Sysmac Studio version 1.28 or lower, do not specify any user-defined variable created in the variable table.



### Precautions for Correct Use

If you specify the same axis for the master axis and slave axis, a Master and Slave Defined as Same Axis minor fault (error code 5436 hex) will occur.

## Function

- The MC\_GearInPos instruction performs gear operation for the slave axis specified with *Slave* (Slave Axis). The following parameters are also specified: *RatioNumerator* (Gear Ratio Numerator), *RatioDenominator* (Gear Ratio Denominator), *ReferenceType* (Position Type), *Acceleration* (Acceleration Rate), and *Deceleration* (Deceleration Rate).
- For *Master* (Master Axis), you can specify the command position, actual position, or most recent command position.

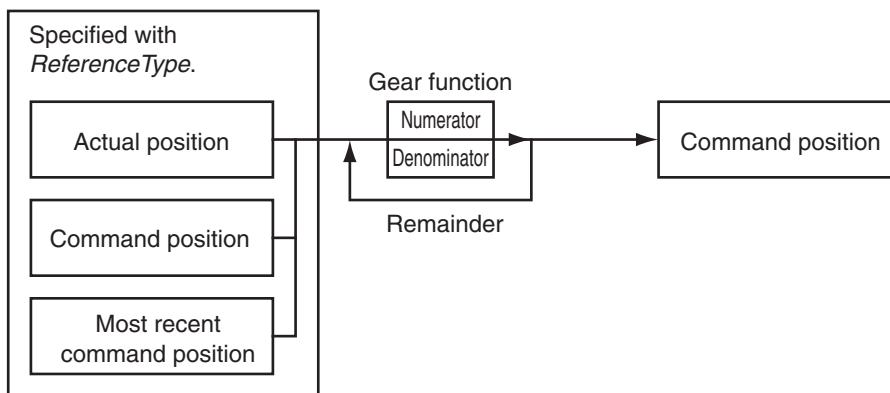

- After operation starts, the *Slave* (Slave Axis) accelerates and decelerates in sync with the *Master* (Master Axis) in the catching operation.
- The slave axis is in the catching phase until it reaches the slave sync position. The slave axis enters the InSync phase after it reaches the slave sync position. For either, the position is synchronized with the master axis.
- The *Velocity* (Target Velocity) input variable is the target velocity for the catching phase.
- The slave axis moves in the same direction as the master axis when operation is started. An error occurs if the master axis velocity is 0 when started. If the master axis is moving in the positive direction and *SlaveSyncPosition* (Slave Sync Position) is smaller than the position of the slave axis when the instruction was executed, the slave axis will reverse direction. If the master axis is moving in the negative direction and *SlaveSyncPosition* (Slave Sync Position) is larger than the position of the slave axis when the instruction was executed, the slave axis will also reverse direction.
- If the master axis velocity changes significantly between periods, the slave axis velocity will not be constant.
- If the gear ratio is positive, the *Slave* (Slave Axis) and the *Master* (Master Axis) move in the same direction.

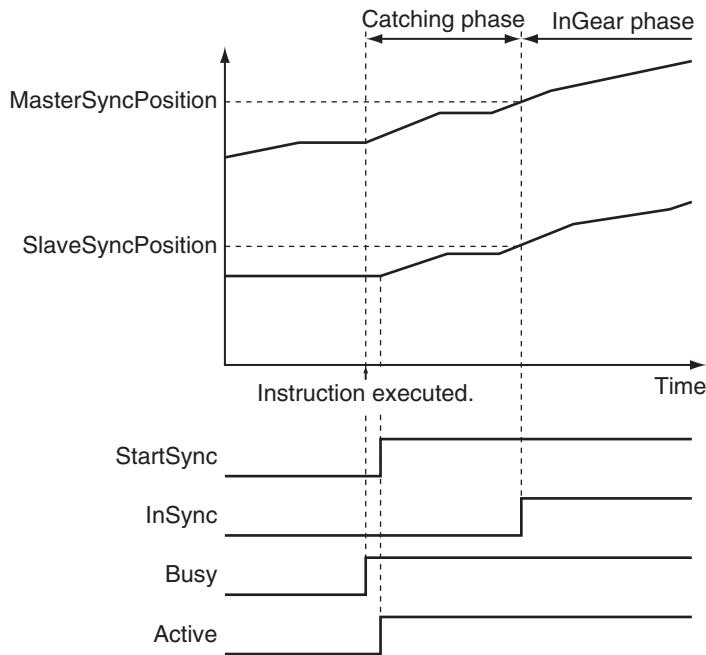

- If the gear ratio is negative, the *Slave* (Slave Axis) and the *Master* (Master Axis) move in the opposite directions.

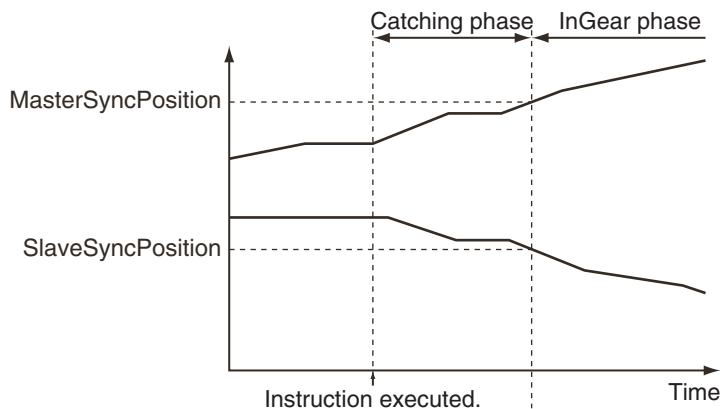

#### Precautions for Correct Use

Do not execute the MC\_SetPosition instruction for the *Master* (Master Axis) if you use this instruction on a CPU Unit with unit version 1.09 or earlier. If the MC\_SetPosition instruction is executed for the *Master* (Master Axis), the *Slave* (Slave Axis) may follow the master axis quickly.

If you want to use the MC\_SetPosition instruction for the *Master* (Master Axis), disable the relationship between the *Master* (Master Axis) and *Slave* (Slave Axis) before executing the instruction.

- The MC Function Module calculates the velocity profile for linear acceleration and deceleration with the following three velocities using the *Acceleration* (Acceleration Rate) and *Deceleration* (Deceleration Rate).
  - a) The velocity of the *Slave* (Slave Axis) when an instruction is executed is the initial velocity.
  - b) The velocity of the *Master* (Master Axis) when an instruction is executed multiplied by the gear ratio is the final velocity.
  - c) The *Velocity* (Target Velocity) is the target velocity.

If the travel distance during the catching phase is too short, the target velocity will not be reached.

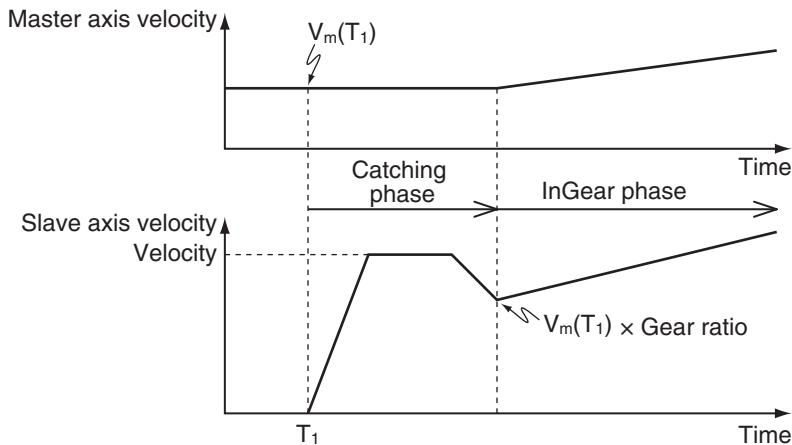

For the *Slave* (Slave Axis) to catch up with the *Master* (Master Axis) for the *MasterSyncPosition* (Master Sync Position) and *SlaveSyncPosition* (Slave Sync Position), the following condition must be met for the *Velocity* (Target Velocity).

$$\text{Velocity} > \frac{\text{Master axis velocity when MC\_GearInPos is executed} \times \text{Gear ratio numerator}}{\text{Gear ratio denominator}}$$

The information that is used as the master axis velocity depends on the setting of *ReferenceType* (Position Type Selection).

Setting of <i>ReferenceType</i>	Information used as the master axis velocity
When <i>_mcCommand</i> or <i>_mcLatestCommand</i> is set	Use the command current velocity.
When <i>_mcFeedback</i> is set	Use the actual current velocity.

If the *Slave* (Slave Axis) cannot catch up with the *Master* (Master Axis) for the *MasterSyncPosition* (Master Sync Position) and *SlaveSyncPosition* (Slave Sync Position), a Positioning Gear Operation Insufficient Target Velocity error (error code 5447 hex) will occur.

- When the Count Mode is set to **Rotary Mode**, the operation is different for different unit versions of the CPU Unit as described below.
  - a) CPU Units with Unit Version 1.10 or Later
 

When the Count Mode of the master axis is **Rotary Mode**, you can specify a *MasterSyncPosition* (Master Sync Position) outside the range specified by the modulo maximum position and modulo minimum position setting values. If you do, the relationship between the master axis current position and the master axis sync position will be the same as when *\_mcNoDirection* (No direction) is specified for *Direction* in the *MC\_MoveAbsolute* (Absolute Positioning) instruction. Refer to *MC\_MoveAbsolute* on page 3-52 for information on the *MC\_MoveAbsolute* (Absolute Positioning) instruction.

In the same way, when the Count Mode of the slave axis is **Rotary Mode**, you can specify a *SlaveSyncPosition* (Slave Sync Position) outside the range specified by the modulo maximum position and modulo minimum position setting values.
  - b) CPU Units with Unit Version 1.09 or Earlier
 

If you set the Count Mode to **Rotary Mode**, make sure that the synchronous operation starts within one cycle of the ring counter.





### Precautions for Correct Use

Refer to 1-1-3 *Precautions for Master and Auxiliary Axes in Synchronized Control* on page 1-6 for precautions on the master axis.

## ● ReferenceType (Position Type Selection)

You can select one of the following position types.

- **\_mcCommand**: Command position (value calculated in the previous task period)  
The master axis command position that was calculated in the previous task period is used for the current period.  
The command value that was calculated for the master axis in the last periodic task is used to calculate the command position of the slave axis in the current period.
- **\_mcFeedback**: Value obtained in the same task period  
The actual position of the master axis that was obtained in the same task period is used.
- **\_mcLatestCommand**: Command position (value calculated in the same task period)  
The command position of the master axis that was calculated in the same task period is used. This enables the use of information that is more recent than for **\_mcCommand**. However, the axis number of the master axis must be set lower than the axis number of the slave axis.  
If the axis number of the slave axis is lower than the axis number of the master axis, *Error* will change to TRUE. A Master/Slave Axis Numbers Not in Ascending Order error (error code: 5438 hex) will be output to *ErrorID*.



### Precautions for Correct Use

Here, the task period is the primary period if the task is the primary periodic task and the task period of the priority-5 periodic task if the task is the priority-5 periodic task. In the same way, the periodic task is the primary periodic task or the priority-5 periodic task.



### Additional Information

The command position that is calculated in the same task period enables greater precision in synchronization than the command position that was calculated in the previous task period. However, the axis number set for the *Master* (Master Axis) in the system-defined variable for motion control must be lower than the axis number set for the *Slave* (Slave Axis) in the system-defined variable for motion control.

## ● Relationship between Axis Types and Position Types

The relationship between the axis types that you can monitor and position types that is monitored is shown below.

Axis Type	ReferenceType	
	_mcCommand or _mcLatestCommand	_mcFeedback
Servo axis	OK	OK
Encoder axis	No *1	OK
Virtual servo axis	OK	OK
Virtual encoder axis	No *1	OK

\*1. A Position Type Selection Out of Range error (error code: 5430 hex) occurs when the instruction is executed.

## Timing Charts

- Electronic gear operation starts when *Execute* changes to TRUE.
- *Busy* (Executing) changes to TRUE when *Execute* changes to TRUE. After the operation is started, *Active* (Controlling) and *StartSync* (Following) change to TRUE and the *Slave* (Slave Axis) starts the gear operation.
- When the *MasterSyncPosition* (Master Sync Position) and *SlaveSyncPosition* (Slave Sync Position) are reached, *InSync* changes to TRUE.
- If another instruction aborts this instruction, *CommandAborted* changes to TRUE, and *Busy* (Executing), *Active* (Controlling), *StartSync* (Following), and *InSync* change to FALSE.

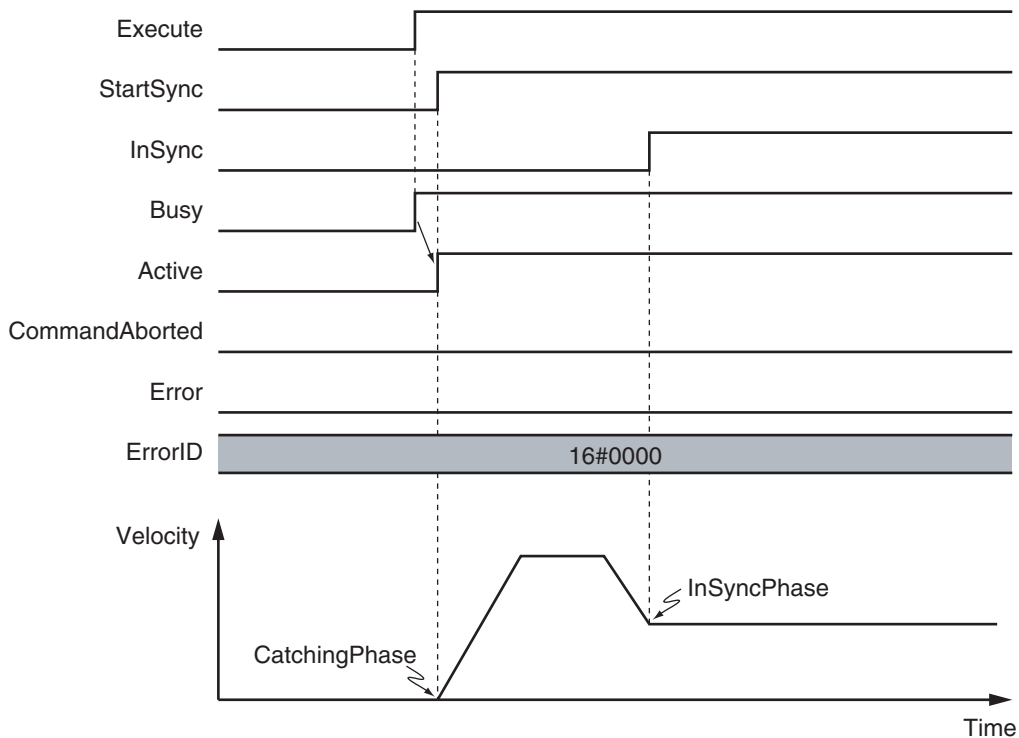

The operation when this instruction is aborted by another instruction is shown below.

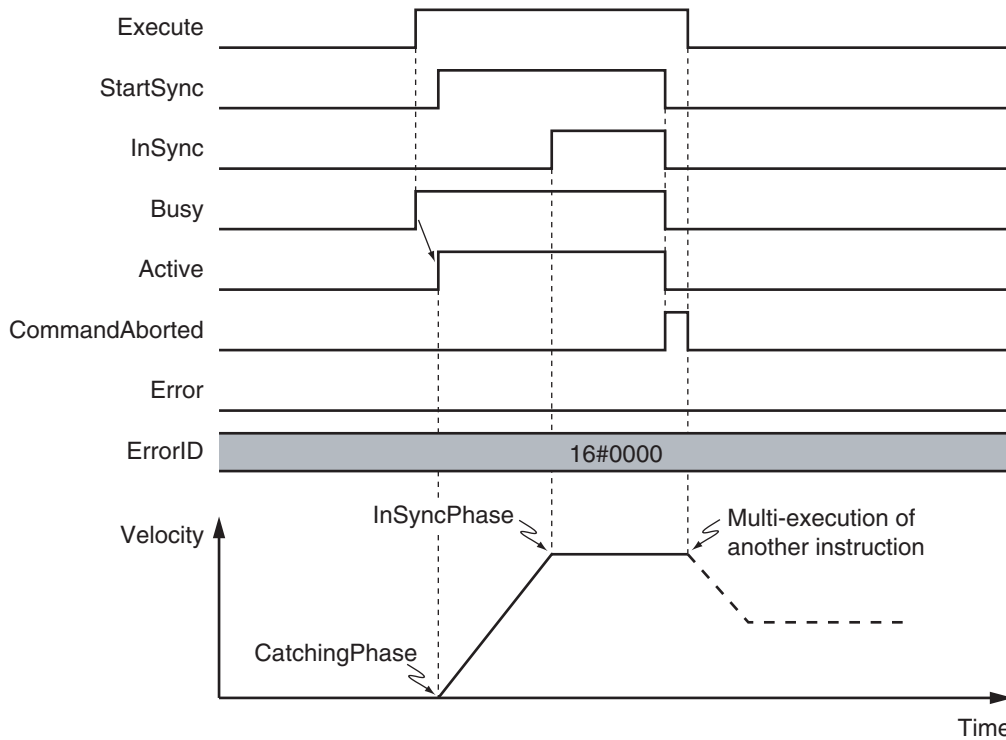

Depending on the setting of the *SlaveSyncPosition*, the axis may not reach the target velocity. An example of this is shown below.

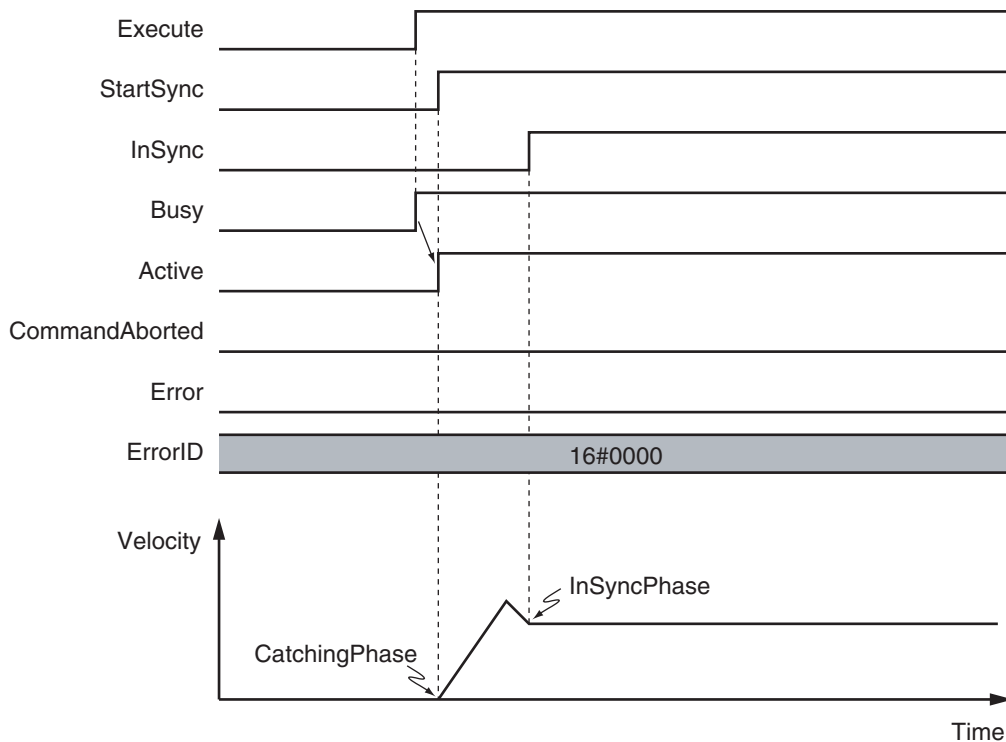

The slave axis follows the master axis position before the InSync phase as well. An example of this is shown below.

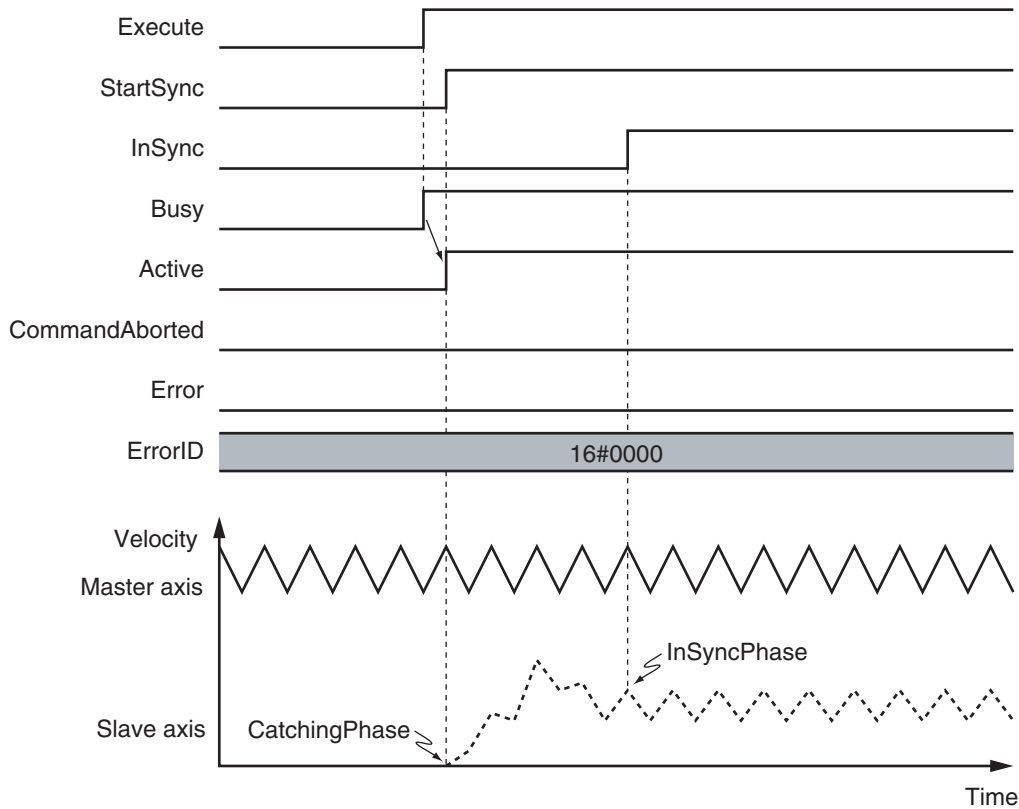

You can specify the *Acceleration* (Acceleration Rate) and *Deceleration* (Deceleration Rate) as input variables. The following figures show operation examples of the electronic gear.

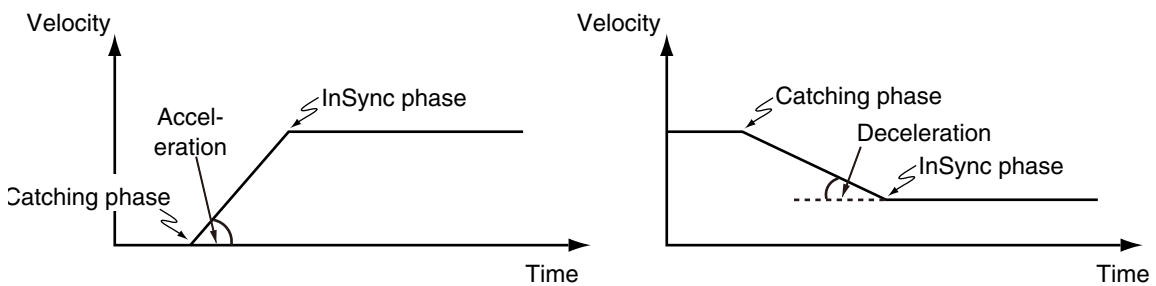

## Re-execution of Motion Control Instructions

This instruction cannot be re-executed.

A Motion Control Instruction Re-execution Disabled error (error code: 543B hex) occurs if re-execution is attempted.

## Multi-execution of Motion Control Instructions

The axis command status of the master axis, including whether it is stopped due to an error or it is decelerating to a stop, does not affect the execution of this instruction.

For details on multi-execution of motion control instructions, refer to the *NJ/NX-series CPU Unit Motion Control User's Manual (Cat. No. W507)*.

## ● Execution of Other Instructions during Instruction Execution

Specify the operation of this instruction by using *BufferMode* (Buffer Mode Selection) for multi-execution of instructions.

Buffer Mode Selection	Description
Aborting	Aborts the instruction being executed and switches to this instruction. If the direction of axis motion is reversed by switching instructions, the motion will be reversed according to the <b>Operation Selection at Reversing</b> axis parameter.

For details on *BufferMode* (Buffer Mode Selection), refer to the *NJ/NX-series CPU Unit Motion Control User's Manual (Cat. No. W507)*.



### Precautions for Correct Use

If another instruction is executed with *BufferMode* (Buffer Mode Selection) set to anything other than **Aborting**, an error will occur in the other instruction.

## Errors

If an error occurs during instruction execution, *Error* will change to TRUE.

You can find out the cause of the error by referring to the value output by *ErrorID* (Error Code).

## ● Timing Chart When Error Occurs

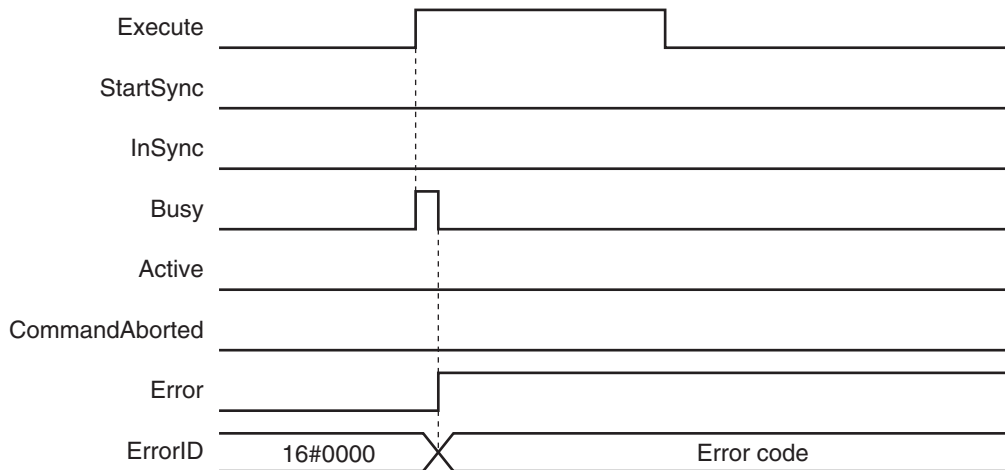

The slave axis is not affected by the error status of the master axis during synchronized control. After the error status of the master axis is cleared, the slave axis continues electronic gear operation when the master axis operates.

The master axis is not affected if an error occurs for the slave axis during startup or execution of this instruction.

## ● Error Codes

Refer to the *NJ/NX-series Troubleshooting Manual (Cat. No. W503)* for instruction errors.

## Sample Programming

This section describes sample programming where the sync position for the master axis is Pos1 and the sync position for the slave axis Pos2.

## Parameter Settings

The minimum settings required for this sample programming are given below.

### ● Setting Axis Parameters

#### Axis Types

Axis	Axis Type
Axis 1	Servo axis (master axis)
Axis 2	Servo axis (slave axis)

#### Count Modes

Axis	Count Mode
Axis 1	Rotary Mode
Axis 2	Rotary Mode

#### Ring Counters

Axis	Modulo maximum position	Modulo minimum position
Axis 1	360	0
Axis 2	360	0

#### Units of Display

Axis	Unit of Display
Axis 1	degree
Axis 2	degree

## Operation Example

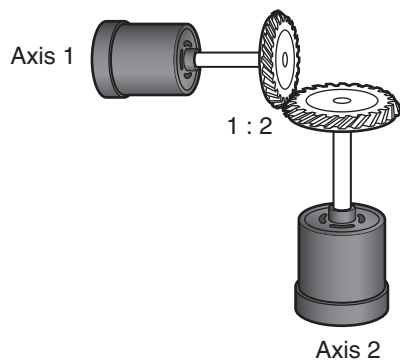

## ● Operation Pattern

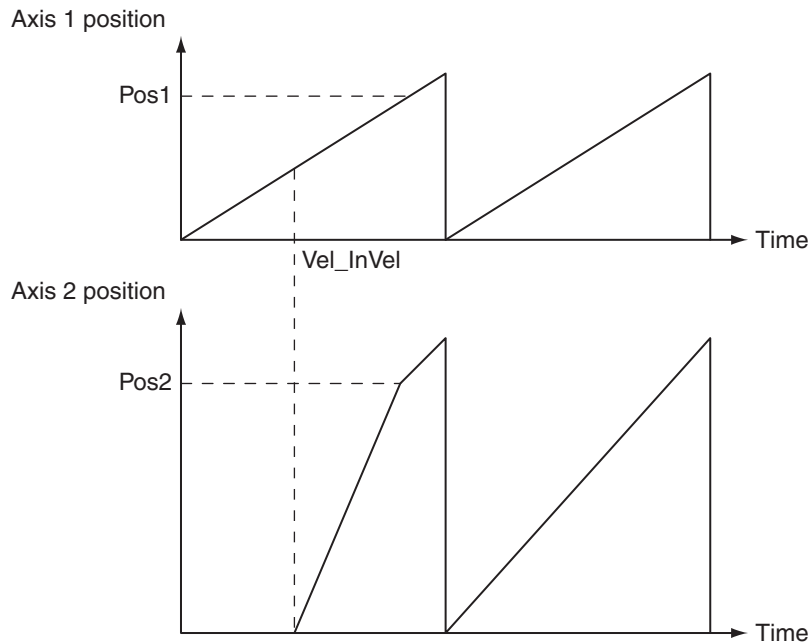

- 1** Starting the Master Axis  
The master axis (axis 1) is an actual servo axis and it is operated with velocity control.
- 2** Reaching Target Velocity for Master Axis  
When the command velocity of the master axis reaches the target velocity, *InVelocity* (Target Velocity Reached) of the master axis changes to TRUE.
- 3** Executing the Slave Axis  
When *InVelocity* (Target Velocity Reached) of the master axis changes to TRUE, the slave axis (axis 2) performs gear operation with a gear ratio of 1:2 against the actual position of the master axis.  
The synchronized positions are Pos1 for the master axis and Pos2 for the slave axis.

## Ladder Diagram

### ● Main Variables

Name	Data type	Default	Comment
MC_Axis000	_sAXIS_REF	---	Axis Variable for the master axis, axis 1.
MC_Axis000.Details.Homed	BOOL	FALSE	TRUE when home is defined for axis 1.
MC_Axis000.MFaultLvl.Active	BOOL	FALSE	TRUE while there is a minor fault level error for axis 1.
MC_Axis001	_sAXIS_REF	---	Axis Variable for the slave axis, axis 2.
MC_Axis001.Details.Homed	BOOL	FALSE	TRUE when home is defined for axis 2.
MC_Axis001.MFaultLvl.Active	BOOL	FALSE	TRUE while there is a minor fault level error for axis 2.

Name	Data type	Default	Comment
Pwr1_Status	BOOL	FALSE	This variable is assigned to the <i>Status</i> output variable from the PWR1 instance of the MC_Power instruction. This variable changes to TRUE when the Servo is turned ON.
Pwr2_Status	BOOL	FALSE	This variable is assigned to the <i>Status</i> output variable from the PWR2 instance of the MC_Power instruction. This variable changes to TRUE when the Servo is turned ON.
Hm1_D	BOOL	FALSE	This variable is assigned to the <i>Done</i> output variable from the HM1 instance of the MC_Home instruction.
Hm2_D	BOOL	FALSE	This variable is assigned to the <i>Done</i> output variable from the HM2 instance of the MC_Home instruction.
Vel_InVel	BOOL	FALSE	This variable is assigned to the <i>InVelocity</i> output variable from the VEL instance of the MC_MoveVelocity instruction. It is TRUE when the target velocity is reached.
Pos1	LREAL	---	This variable gives the master sync position.
Pos2	LREAL	---	This variable gives the slave sync position.
StartPg	BOOL	FALSE	The Servo is turned ON if this variable is TRUE and EtherCAT process data communications are established.



● **Timing Chart**

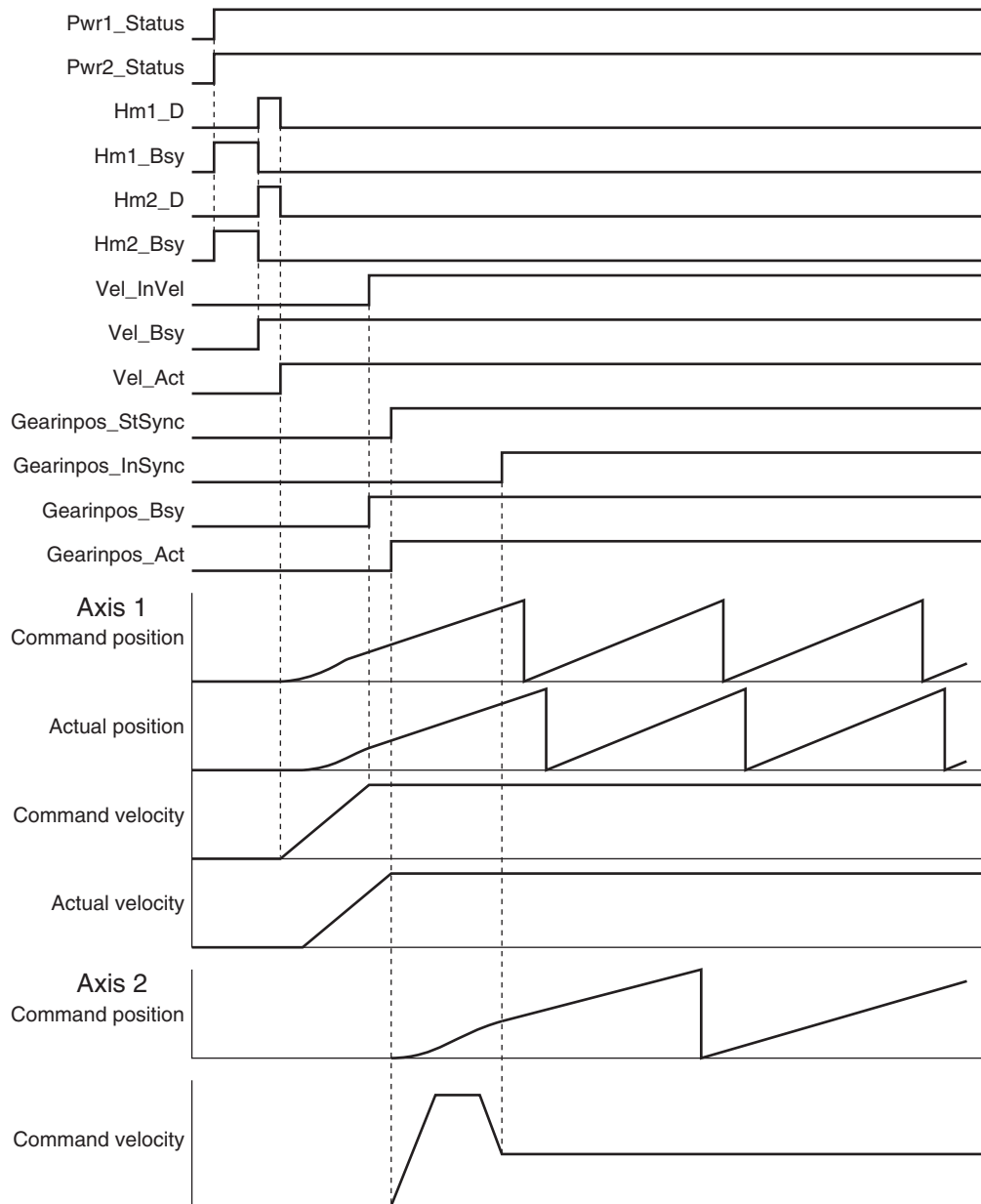

● **Sample Programming**

If *StartPg* is TRUE, check that the Servo Drives for each axis are ready.

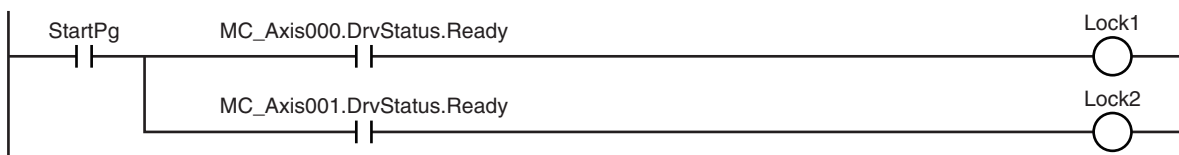

If the Servo Drives are ready, the Servos are turned ON for each axis.

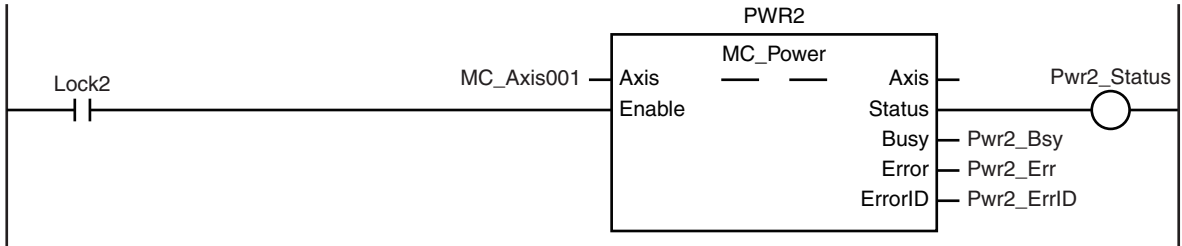
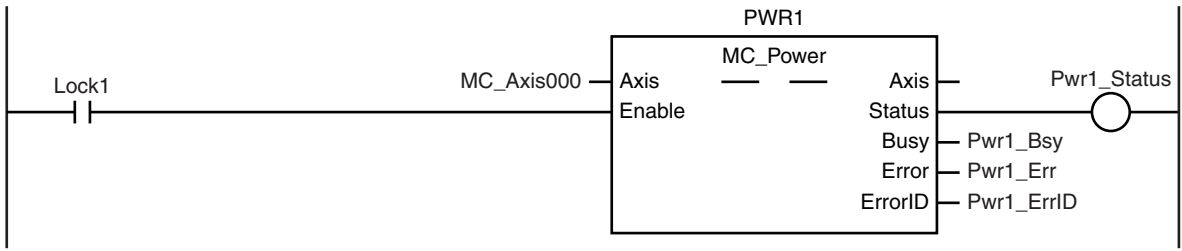

If a minor fault level error occurs for the axis composition, the error handler for the device (FaultHandler) is executed.  
Program the FaultHandler according to the device.

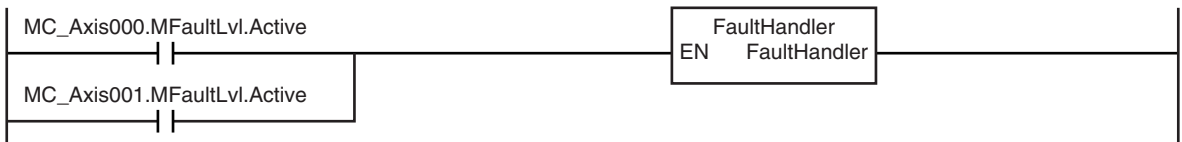

If the Servo is ON for the master axis (axis 1) and home is not defined, the Home instruction is executed to define home.

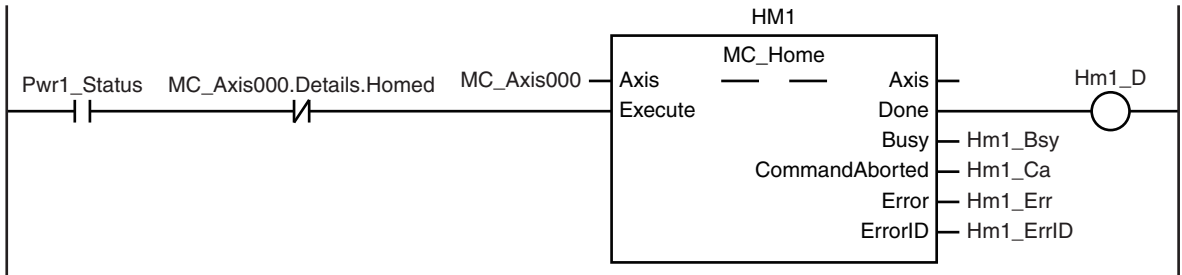

If the Servo is ON for the slave axis (axis 2) and home is not defined, the Home instruction is executed to define home.

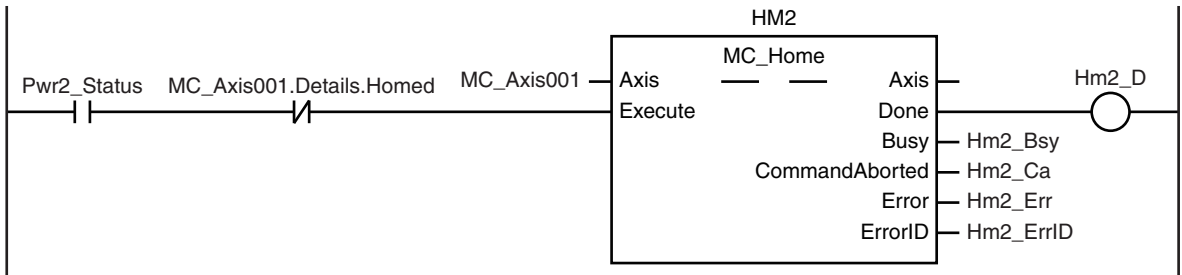

The MC\_MoveVelocity (Velocity Control) instruction is executed after homing is completed for the master axis (axis 1).

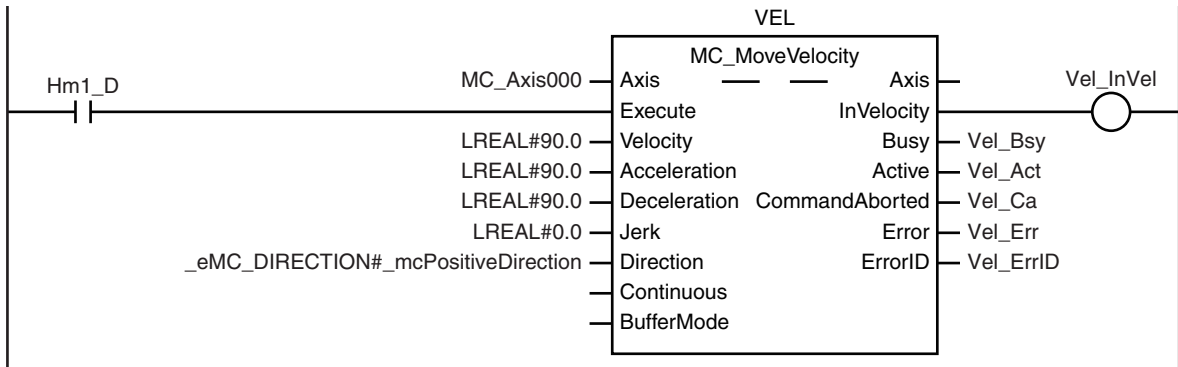

After homing is completed for axis 2 (slave axis), MC\_GearInPos (Positioning Gear Operation) is executed to start gear operation if *Vel\_InVel* of MC\_MoveVelocity is TRUE.

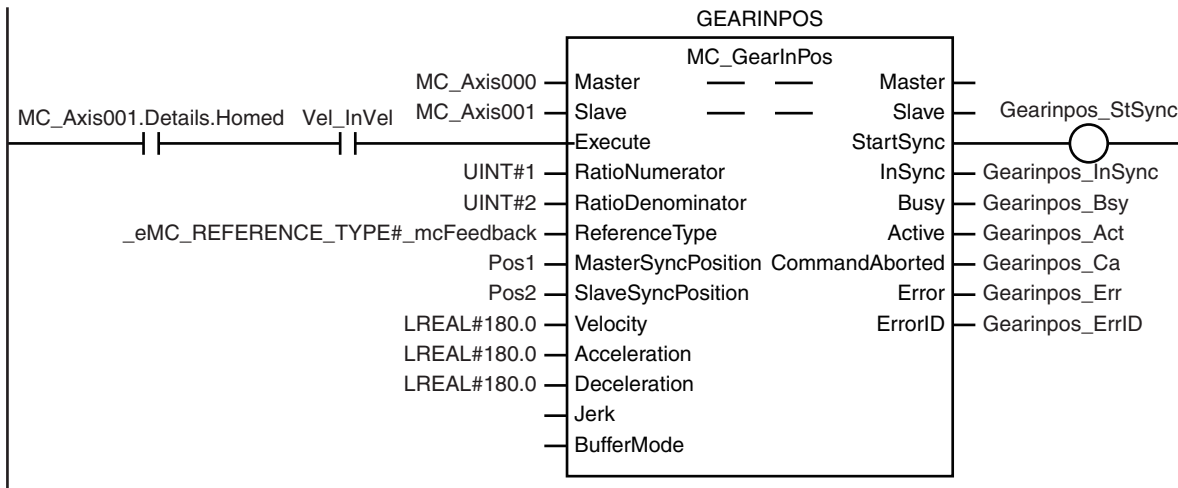

## Structured Text (ST)

### ● Main Variables

Name	Data type	Default	Comment
MC_Axis000	_sAXIS_REF	---	Axis Variable for the master axis, axis 1.
MC_Axis000.Details.Homed	BOOL	FALSE	TRUE when home is defined for axis 1.
MC_Axis000.MFaultLvl.Active	BOOL	FALSE	TRUE while there is a minor fault level error for axis 1.
MC_Axis001	_sAXIS_REF	---	Axis Variable for the slave axis, axis 2.
MC_Axis001.Details.Homed	BOOL	FALSE	TRUE when home is defined for axis 2.
MC_Axis001.MFaultLvl.Active	BOOL	FALSE	TRUE while there is a minor fault level error for axis 2.
Pwr1_Status	BOOL	FALSE	This variable is assigned to the <i>Status</i> output variable from the PWR1 instance of the MC_Power instruction. This variable changes to TRUE when the Servo is turned ON.

Name	Data type	Default	Comment
Pwr2_Status	BOOL	FALSE	This variable is assigned to the <i>Status</i> output variable from the PWR2 instance of the MC_Power instruction. This variable changes to TRUE when the Servo is turned ON.
Hm1_D	BOOL	FALSE	This variable is assigned to the <i>Done</i> output variable from the HM1 instance of the MC_Home instruction.
Hm2_D	BOOL	FALSE	This variable is assigned to the <i>Done</i> output variable from the HM2 instance of the MC_Home instruction.
Vel_InVel	BOOL	FALSE	This variable is assigned to the <i>InVelocity</i> output variable from the VEL instance of the MC_MoveVelocity instruction. It is TRUE when the target velocity is reached.
Pos1	LREAL	---	This variable gives the master sync position.
Pos2	LREAL	---	This variable gives the slave sync position.
StartPg	BOOL	FALSE	The Servo is turned ON if this variable is TRUE and EtherCAT process data communications are established.
Gearinpos_Ex	BOOL	FALSE	The GEARIN1 instance of MC_GearInPos is executed when this variable changes to TRUE.
Vel_Ex	BOOL	FALSE	The VEL instance of MC_MoveVelocity is executed when this variable changes to TRUE.
InitFlag	BOOL	FALSE	This variable indicates if it is necessary to set the input parameters. Input parameters are set when this variable is FALSE. When setting the input parameters is completed, this variable changes to TRUE.

## ● Timing Chart

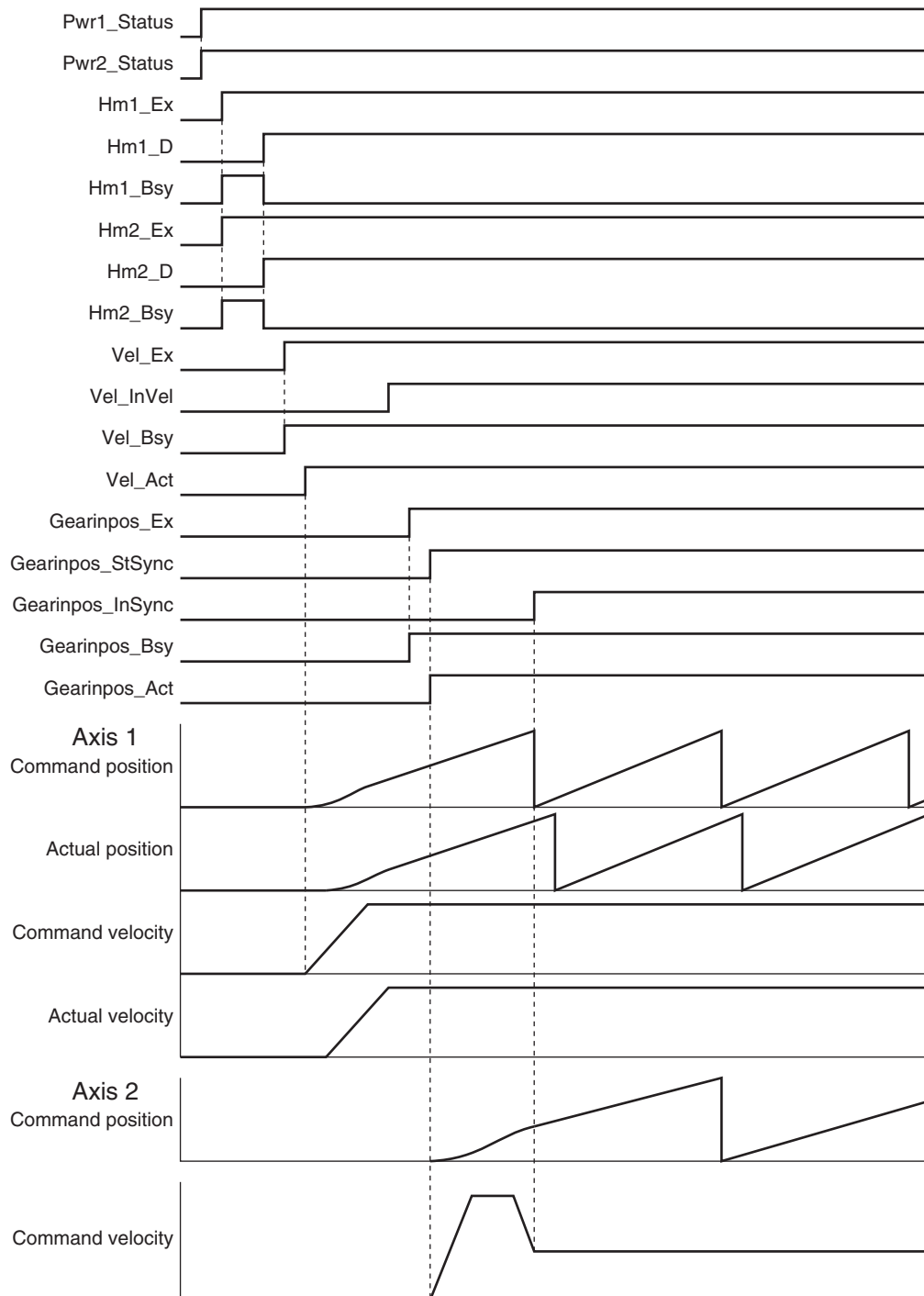

## ● Sample Programming

```
// Processing when input parameters are not set
IF InitFlag = FALSE THEN

    // MC_MoveVelocity parameters
    Vel_Vel := LREAL#90.0;
    Vel_Acc := LREAL#90.0;
    Vel_Dec := LREAL#90.0;
```

```

Vel_Dir := _eMC_DIRECTION#_mcPositiveDirection;

// MC_GearInPos parameters
Pos1 := LREAL#300.0;
Pos2 := LREAL#200.0;
Gearinpos_Rn := UINT#1;
Gearinpos_Rd := UINT#2;
Gearinpos_Rt := _eMC_REFERENCE_TYPE#_mcFeedback;
Gearinpos_Mtpos := Pos1;
Gearinpos_Svpos := Pos2;
Gearinpos_Vel := LREAL#180.0;
Gearinpos_Acc := LREAL#180.0;
Gearinpos_Dec := LREAL#180.0;

// Change InitFlag to TRUE after setting the input parameters.
InitFlag:=TRUE;

END_IF;

// If StartPg is TRUE and the Servo Drive is ready, the Servo for axis 1 is turned
ON.
// If the Servo Drive is not ready, the Servo is turned OFF.
IF (StartPg=TRUE)
  AND (MC_Axis000.DrvStatus.Ready=TRUE) THEN
    Pwr1_En:=TRUE;
  ELSE
    Pwr1_En:=FALSE;
  END_IF;

// If StartPg is TRUE and the Servo Drive is ready, the Servo for axis 2 is turned
ON.
// If the Servo Drive is not ready, the Servo is turned OFF.
IF (StartPg=TRUE)
  AND (MC_Axis001.DrvStatus.Ready=TRUE) THEN
    Pwr2_En:=TRUE;
  ELSE
    Pwr2_En:=FALSE;
  END_IF;

// If a minor fault level error occurs for axis 1 or axis 2, the error handler for
the device (FaultHandler) is executed.
// Program the FaultHandler according to the device.
IF (MC_Axis000.MFaultLvl.Active=TRUE) OR (MC_Axis001.MFaultLvl.Active=TRUE) THEN
  FaultHandler();
END_IF;

// If the Servo is ON for axis 1 and home is not defined, the Home instruction is e

```

```

xecuted.
IF (Pwr1_Status=TRUE) AND (MC_Axis000.Details.Homed=FALSE) THEN
    Hm1_Ex:=TRUE;
END_IF;

// If the Servo is ON for axis 2 and home is not defined, the Home instruction is e
xecuted.
IF (Pwr2_Status=TRUE) AND (MC_Axis001.Details.Homed=FALSE) THEN
    Hm2_Ex:=TRUE;
END_IF;

// After homing is completed for axis 1, MC_MoveVelocity is executed.
IF Hm1_D=TRUE THEN
    Vel_Ex := TRUE;
END_IF;

// After homing is completed for axis 2, MC_GearInPos is executed when Vel_InVel of
MC_MoveVelocity is TRUE.
IF (MC_Axis001.Details.Homed=TRUE) AND (Vel_InVel=TRUE) THEN
    Gearinpos_Ex := TRUE;
END_IF;

// MC_Power for axis 1
PWR1(
    Axis := MC_Axis000,
    Enable := Pwr1_En,
    Status => Pwr1_Status,
    Busy => Pwr1_Bsy,
    Error => Pwr1_Err,
    ErrorID => Pwr1_ErrID
);

// MC_Power for axis 2
PWR2(
    Axis := MC_Axis001,
    Enable := Pwr2_En,
    Status => Pwr2_Status,
    Busy => Pwr2_Bsy,
    Error => Pwr2_Err,
    ErrorID => Pwr2_ErrID
);

// MC_Home for axis 1
HM1(
    Axis := MC_Axis000,
    Execute := Hm1_Ex,
    Done => Hm1_D,

```

```
    Busy => Hm1_Bsy,
    CommandAborted => Hm1_Ca,
    Error => Hm1_Err,
    ErrorID => Hm1_ErrID
);

// MC_Home for axis 2
HM2 (
    Axis := MC_Axis001,
    Execute := Hm2_Ex,
    Done => Hm2_D,
    Busy => Hm2_Bsy,
    CommandAborted => Hm2_Ca,
    Error => Hm2_Err,
    ErrorID => Hm2_ErrID
);

//MC_MoveVelocity
VEL(
    Axis := MC_Axis000,
    Execute := Vel_Ex,
    Velocity := Vel_Vel,
    Acceleration := Vel_Acc,
    Deceleration := Vel_Dec,
    Direction := Vel_Dir,
    InVelocity => Vel_InVel,
    Busy => Vel_Bsy,
    Active => Vel_Act,
    CommandAborted => Vel_Ca,
    Error => Vel_Err,
    ErrorID => Vel_ErrID
);

//MC_GearInPos
GEARINPOS (
    Master := MC_Axis000,
    Slave := MC_Axis001,
    Execute := Gearinpos_Ex,
    RatioNumerator := Gearinpos_Rn,
    RatioDenominator := Gearinpos_Rd,
    ReferenceType := Gearinpos_Rt,
    MasterSyncPosition := Gearinpos_Mtpos,
    SlaveSyncPosition := Gearinpos_Svpos,
    Velocity := Gearinpos_Vel,
    Acceleration := Gearinpos_Acc,
    Deceleration := Gearinpos_Dec,
    StartSync => Gearinpos_StSync,
```



```
InSync => Gearinpos_InSync,  
Busy => Gearinpos_Bsy,  
Active => Gearinpos_Act,  
CommandAborted => Gearinpos_Ca,  
Error => Gearinpos_Err,  
ErrorID => Gearinpos_ErrID  
);
```

# MC\_GearOut

The MC\_GearOut instruction stops operation for the MC\_GearIn (Start Gear Operation) instruction or MC\_GearInPos (Positioning Gear Operation) instruction.

Instruction	Name	FB/ FUN	Graphic expression	ST expression
MC_GearOut	End Gear Operation	FB		<pre>MC_GearOut_instance (   Slave :=parameter,   Execute :=parameter,   Deceleration :=parameter,   Jerk :=parameter,   OutMode :=parameter,   Done =&gt;parameter,   Busy =&gt;parameter,   CommandAborted =&gt;parameter,   Error =&gt;parameter,   ErrorID =&gt;parameter );</pre>

## Variables

### Input Variables

Name	Meaning	Data type	Valid range	De- fault	Description
Execute	Execute	BOOL	TRUE or FALSE	FALS E	The instruction is executed when the value of this variable changes to TRUE.
Deceleration	Decelera- tion Rate	LREAL	Non-negative number	0	Specify the deceleration rate. The unit is command units/s <sup>2</sup> . *1
Jerk (Reserved)	Jerk	LREAL	0	0	(Reserved)
OutMode (Reserved)	Sync End Mode Se- lection	_eMC_OUT_MODE	0: _mcStop	0 *2	(Reserved)

\*1. Refer to *Unit Conversion Settings* in the *NJ/NX-series CPU Unit Motion Control User's Manual (Cat. No. W507)* for information on command units.

\*2. The default value for an enumeration variable is actually not the number, but the enumerator.

### Output Variables

Name	Meaning	Data type	Valid range	Description
Done	Done	BOOL	TRUE or FALSE	TRUE when the instruction is completed.
Busy	Executing	BOOL	TRUE or FALSE	TRUE when the instruction is acknowledged.

Name	Meaning	Data type	Valid range	Description
CommandAborted	Command Aborted	BOOL	TRUE or FALSE	TRUE when the instruction is aborted.
Error	Error	BOOL	TRUE or FALSE	TRUE while there is an error.
ErrorID	Error Code	WORD	*1	Contains the error code when an error occurs. A value of 16#0000 indicates normal execution.

\*1. The upper four digits of the event code give the error code for ErrorID. Refer to the *NJ/NX-series Troubleshooting Manual (Cat. No. W503)* for the event codes.

### ● Output Variable Update Timing

Name	Timing for changing to TRUE	Timing for changing to FALSE
Done	When the instruction is completed.	<ul style="list-style-type: none"> <li>When <i>Execute</i> is TRUE and changes to FALSE.</li> <li>After one period when <i>Execute</i> is FALSE.</li> </ul>
Busy	When <i>Execute</i> changes to TRUE.	<ul style="list-style-type: none"> <li>When <i>Done</i> changes to TRUE.</li> <li>When <i>Error</i> changes to TRUE.</li> <li>When <i>CommandAborted</i> changes to TRUE.</li> </ul>
CommandAborted	<ul style="list-style-type: none"> <li>When this instruction is aborted because another motion control instruction was executed with the Buffer Mode set to <b>Aborting</b>.</li> <li>When this instruction is canceled due to an error.</li> <li>When this instruction is executed while there is an error.</li> <li>When you start this instruction during MC_Stop instruction execution.</li> </ul>	<ul style="list-style-type: none"> <li>When <i>Execute</i> is TRUE and changes to FALSE.</li> <li>After one period when <i>Execute</i> is FALSE.</li> </ul>
Error	When there is an error in the execution conditions or input parameters for the instruction.	When the error is cleared.

## In-Out Variables

Name	Meaning	Data type	Valid range	Description
Slave	Slave Axis	_sAXIS_REF	---	Specify the slave axis. *1

\*1. Specify a user-defined Axis Variable that was created in the Axis Basic Settings of the Sysmac Studio (default: MC\_Axis\*) or a system-defined axis variable name (\_MC\_AX[\*], \_MC1\_AX[\*], or \_MC2\_AX[\*]).

If you use Sysmac Studio version 1.29 or higher, you can specify the system-defined axis variable name for AT specification of a user-defined variable. This will allow you to specify the user-defined variable.

If you use Sysmac Studio version 1.28 or lower, do not specify any user-defined variable created in the variable table.

## Function

- The MC\_GearOut instruction stops the operation of the MC\_GearIn (Start Gear Operation) or MC\_GearInPos (Positioning Gear Operation) instruction for the operation axis specified with *Slave* and at the specified *Deceleration* (Deceleration Rate).
- This instruction does not affect the MC\_GearIn (Start Gear Operation) or MC\_GearInPos (Positioning Gear Operation) operation of the master axis.

## Timing Charts

- *Busy* (Executing) changes to TRUE when *Execute* changes to TRUE.
- *Done* changes to TRUE when the target velocity is reached.
- If another instruction aborts this instruction, *CommandAborted* changes to TRUE and *Busy* (Executing) changes to FALSE.

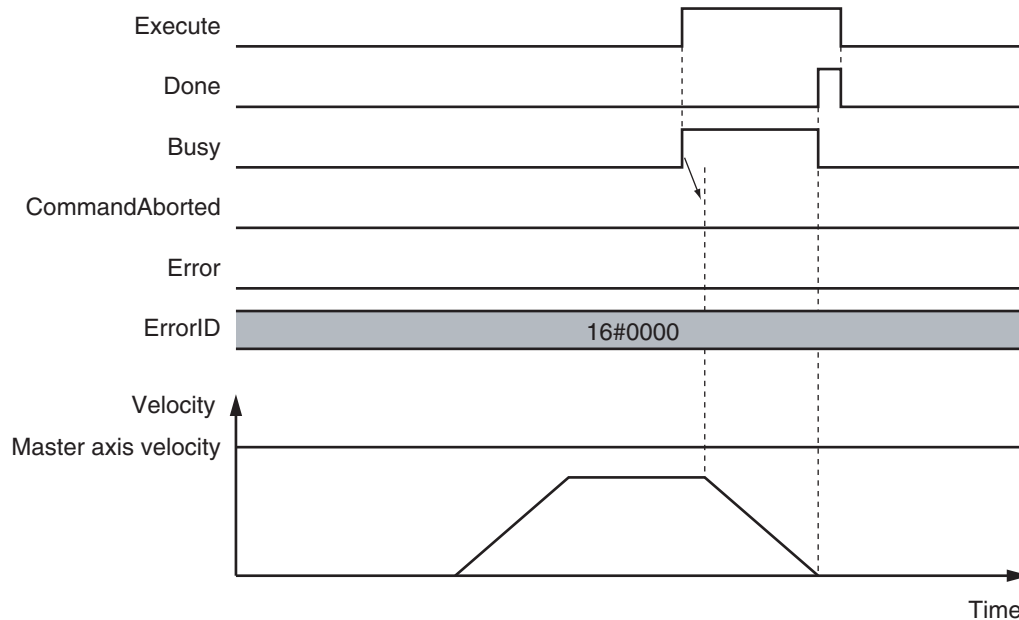

### ● When This Instruction Is Aborted by Another Instruction

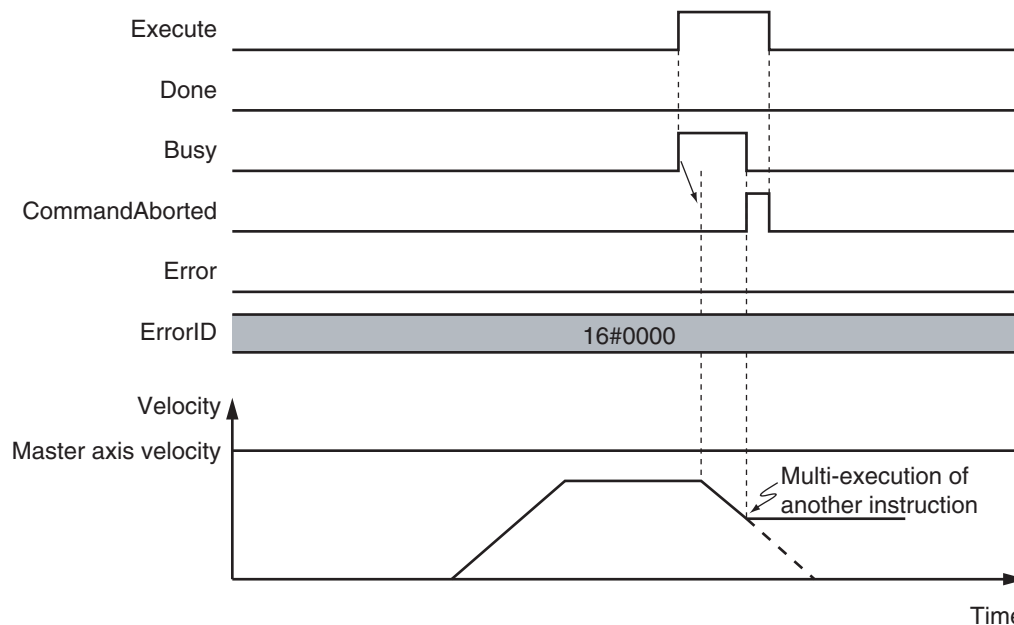

### ● When The Instruction Is Executed with a *Deceleration* (Deceleration Rate) of 0

If *Deceleration* (Deceleration Rate) is set to 0 and the instruction is executed, the axis will stop without decelerating.

The following chart shows an operation example of when *Deceleration* (Deceleration Rate) is 0.

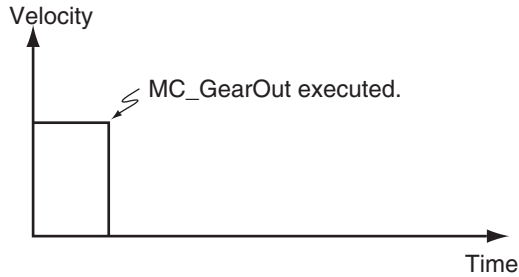

## Re-execution of Motion Control Instructions

This instruction cannot be re-executed.

A Motion Control Instruction Re-execution Disabled error (error code: 543B hex) occurs if re-execution is attempted.

## Multi-execution of Motion Control Instructions

For details on multi-execution of motion control instructions, refer to the *NJ/NX-series CPU Unit Motion Control User's Manual (Cat. No. W507)*.

### ● Execution during Execution of Other Instructions

If you execute this instruction while MC\_GearIn (Start Gear Operation) or MC\_GearInPos (Positioning Gear Operation) instruction is in execution, *CommandAborted* for MC\_GearIn or MC\_GearInPos will change to TRUE and *Busy* (Executing) of this instruction will change to TRUE.

If you execute this instruction while instructions other than MC\_GearIn or MC\_GearInPos are in execution, this instruction will result in an *Error*.

### ● Execution of Other Instructions during Instruction Execution

To use multi-execution of motion instructions for this instruction, specify the slave axis.

If you execute another instruction during execution of this instruction, you can set the Buffer Mode to either **Aborting** or **Buffered**.

## Errors

If an error occurs during instruction execution, *Error* will change to TRUE.

You can find out the cause of the error by referring to the value output by *ErrorID* (Error Code).

● **Timing Chart When Error Occurs**

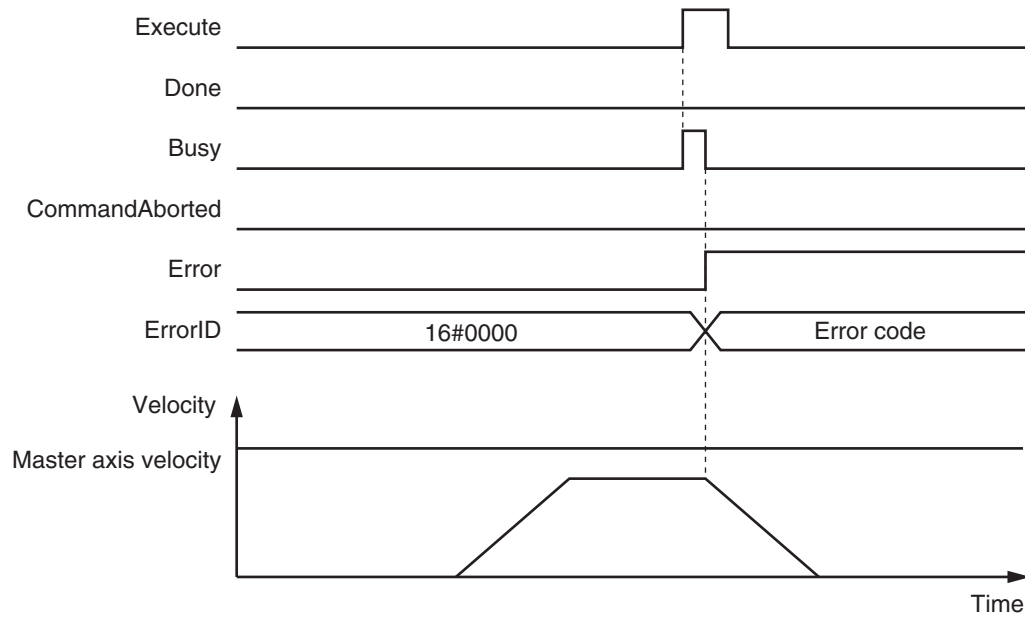

● **Error Codes**

Refer to the *NJ/NX-series Troubleshooting Manual (Cat. No. W503)* for instruction errors.

# MC\_MoveLink

Positioning is performed in sync with the specified master axis.

Instruction	Name	FB/ FUN	Graphic expression	ST expression
MC_MoveLink	Synchronous Positioning	FB		<pre>MC_MoveLink_instance (   Master :=parameter,   Slave :=parameter,   TriggerInput :=parameter,   TriggerVariable :=parameter,   Execute :=parameter,   ReferenceType :=parameter,   SlaveDistance :=parameter,   MasterDistance :=parameter,   MasterDistanceIn-   nACC :=parameter,   MasterDistanceIn-   DEC :=parameter,   LinkOption :=parameter,   MasterStartDistance :=parameter,   BufferMode :=parameter,   Done =&gt;parameter,   InSync =&gt;parameter,   Busy =&gt;parameter,   Active =&gt;parameter,   CommandAborted =&gt;parameter,   Error =&gt;parameter,   ErrorID =&gt;parameter );</pre>

MC\_MoveLink

3

Variables

## Variables

### Input Variables

Name	Meaning	Data type	Valid range	Default	Description
Execute	Execute	BOOL	TRUE or FALSE	FALSE	The instruction is executed when the value of this variable changes to TRUE.
Reference-Type *1	Position Type Selection	_eMC_REFERENCE_TYPE	0: _mcCommand 1: _mcFeedback 2: _mcLatestCommand	0 *2	Specify the position type. 0: Command position (value calculated in the previous task period *3) 1: Actual position (value obtained in the same task period *3) 2: Command position (value calculated in the same task period *3)

Name	Meaning	Data type	Valid range	Default	Description
SlaveDis- tance	Slave Axis Travel Dis- tance	LREAL	Negative number, positive number, or 0	0	Specify the travel distance of the slave axis. The unit is command units. *4
MasterDis- tance	Master Axis Travel Dis- tance	LREAL	Non-negative number	0	Specify the travel distance of the master axis as an unsigned absolute value. The value is valid for both positive and nega- tive travel of the master axis. The unit is command units. *4
MasterDistan- celnACC	Master Dis- tance in Ac- celeration	LREAL	Non-negative number	0	Specify the travel distance of the master axis while the slave axis is accelerating. Specify the unsigned absolute value. The value is valid for both positive and negative travel of the mas- ter axis. The unit is command units. *4
MasterDistan- celnDEC	Master Dis- tance in De- celeration	LREAL	Non-negative number	0	Specify the travel distance of the master axis while the slave axis is decelerating. Specify the unsigned absolute value. The value is valid for both positive and negative travel of the mas- ter axis. The unit is command units. *4
LinkOption	Synchroni- zation Start Condition	_eMC_LINKOP- TION	0: _mcCommandExecution 1: _mcTriggerDetection 2: _mcMasterReach	0 *2	Specify the condition for the slave axis to synchronize with the master axis. 0: When instruction execution starts 1: When trigger is detected 2: When the master axis reach- es the master following dis- tance.
MasterStart Distance	Master Fol- lowing Dis- tance	LREAL	Negative number, positive number, or 0	0	Specify the absolute position of the master axis when the slave axis starts following the master axis. The unit is command units. *4
BufferMode	Buffer Mode Selection	_eMC_BUF- FER_MODE	0: _mcAborting 1: _mcBuffered	0 *2	Specify the behavior when exe- cuting more than one motion in- struction. 0: Aborting 1: Buffered

\*1. To use `_mcLatestCommand`, the following condition must be met for the master and slave axes.

When you use this variable, the axis number set for the *Master* (Master Axis) in the system-defined variable for motion control must be lower than the axis number set for the *Slave* (Slave Axis) in the system-defined variable for motion control.

\*2. The default value for an enumeration variable is actually not the number, but the enumerator.

\*3. The task period is the primary period if the task is the primary periodic task and the task period of the priority-5 periodic task if the task is the priority-5 periodic task.



- \*4. Refer to *Unit Conversion Settings* in the *NJ/NX-series CPU Unit Motion Control User's Manual (Cat. No. W507)* for information on command units.

## Output Variables

Name	Meaning	Data type	Valid range	Description
Done	Done	BOOL	TRUE or FALSE	TRUE when the instruction is completed.
InSync	In Sync	BOOL	TRUE or FALSE	TRUE when synchronization is started.
Busy	Executing	BOOL	TRUE or FALSE	TRUE when the instruction is acknowledged.
Active	Controlling	BOOL	TRUE or FALSE	TRUE when the axis is being controlled.
CommandAborted	Command Aborted	BOOL	TRUE or FALSE	TRUE when the instruction is aborted.
Error	Error	BOOL	TRUE or FALSE	TRUE while there is an error.
ErrorID	Error Code	WORD	*1	Contains the error code when an error occurs. A value of 16#0000 indicates normal execution.

- \*1. The upper four digits of the event code give the error code for ErrorID. Refer to the *NJ/NX-series Troubleshooting Manual (Cat. No. W503)* for the event codes.

### ● Output Variable Update Timing

Name	Timing for changing to TRUE	Timing for changing to FALSE
Done	When the instruction is completed.	<ul style="list-style-type: none"> <li>When <i>Execute</i> is TRUE and changes to FALSE.</li> <li>After one period when <i>Execute</i> is FALSE.</li> </ul>
InSync	When synchronization conditions are met.	<ul style="list-style-type: none"> <li>When <i>Done</i> changes to TRUE.</li> <li>When <i>Error</i> changes to TRUE.</li> <li>When <i>CommandAborted</i> changes to TRUE.</li> </ul>
Busy	When <i>Execute</i> changes to TRUE.	<ul style="list-style-type: none"> <li>When <i>Done</i> changes to TRUE.</li> <li>When <i>Error</i> changes to TRUE.</li> <li>When <i>CommandAborted</i> changes to TRUE.</li> </ul>
Active	When an instruction is received.	<ul style="list-style-type: none"> <li>When <i>Done</i> changes to TRUE.</li> <li>When <i>Error</i> changes to TRUE.</li> <li>When <i>CommandAborted</i> changes to TRUE.</li> </ul>
CommandAborted	<ul style="list-style-type: none"> <li>When this instruction is aborted because another motion control instruction was executed with the Buffer Mode set to <b>Aborting</b>.</li> <li>When this instruction is canceled due to an error.</li> <li>When this instruction is executed while there is an error.</li> <li>When you start this instruction during MC_Stop instruction execution.</li> </ul>	<ul style="list-style-type: none"> <li>When <i>Execute</i> is TRUE and changes to FALSE.</li> <li>After one period when <i>Execute</i> is FALSE.</li> </ul>
Error	When there is an error in the execution conditions or input parameters for the instruction.	When the error is cleared.

## In-Out Variables

Name	Meaning	Data type	Valid range	Description
Master	Master Axis	_sAXIS_REF	---	Specify the master axis. *1
Slave	Slave Axis	_sAXIS_REF	---	Specify the slave axis. *1
TriggerInput	Trigger Input Condition	_sTRIGGER_REF	---	Set the trigger condition. *2
TriggerVariable	Trigger Variable	BOOL	TRUE or FALSE	Specify the input variable to function as the trigger to specify the controller mode with a trigger condition.

- \*1. Specify a user-defined Axis Variable that was created in the Axis Basic Settings of the Sysmac Studio (default: MC\_Axis\*) or a system-defined axis variable name (\_MC\_AX[\*], \_MC1\_AX[\*], or \_MC2\_AX[\*]).  
If you use Sysmac Studio version 1.29 or higher, you can specify the system-defined axis variable name for AT specification of a user-defined variable. This will allow you to specify the user-defined variable.  
If you use Sysmac Studio version 1.28 or lower, do not specify any user-defined variable created in the variable table.
- \*2. Define a user-defined variable with a data type of \_sTRIGGER\_REF.

### ● \_sTRIGGER\_REF

Name	Meaning	Data type	Valid range	Function
Mode	Mode	_eMC_TRIGGER_MODE	0: _mcDrive 1: _mcController	Specify the trigger mode. 0: Drive Mode 1: Controller Mode
LatchID	Latch ID Selection	_eMC_TRIGGER_LATCH_ID	0: _mcLatch1 1: _mcLatch2	Specify which of the two latch functions to use in <b>Drive Mode</b> . 0: Latch 1 1: Latch 2
InputDrive	Trigger Input Signal	_eMC_TRIGGER_INPUT_DRIVE	0: _mcEncoderMark 1: _mcEXT	Specify the Servo Drive trigger signal to use in <b>Drive Mode</b> . 0: Z-phase signal 1: External input

## Function

- The MC\_MoveLink instruction moves a slave axis in synchronization with a specified master axis.
- A type of electronic cam operation is performed, but synchronous positioning is performed between the slave axis and the master axis.
- Use MC\_Stop to stop the axis during motion for this instruction.



### Precautions for Correct Use

Do not execute the MC\_SetPosition instruction for the *Master* (Master Axis) if you use this instruction on a CPU Unit with unit version 1.09 or earlier.

If the MC\_SetPosition instruction is executed for the *Master* (Master Axis), the *Slave* (Slave Axis) may follow the master axis quickly.

If you want to use the MC\_SetPosition instruction for the *Master* (Master Axis), disable the relationship between the *Master* (Master Axis) and *Slave* (Slave Axis) before executing the instruction.

Refer to 1-1-3 *Precautions for Master and Auxiliary Axes in Synchronized Control* on page 1-6 for precautions on the master axis.

## ● Mapping Data Objects

You must map the following object data when *LinkOption* (Synchronization Start Condition) is set to **\_mcTriggerDetection** and the MC\_MoveLink (Synchronous Positioning) instruction executed with *Mode* set to **Drive Mode**.

Mapping is performed in the **Detailed Settings** Area of the Axis Basic Settings Display of the Sysmac Studio.

- Touch probe function (60B8 hex)
- Touch probe status (60B9 hex)
- Touch probe pos1 pos value (60BA hex)
- Touch probe pos2 pos value (60BC hex)

If even one of the required objects is not set, a Process Data Object Setting Missing error (error code 3461 hex) occurs.

For details on mapping data objects, refer to *2-3 PDO Mapping* on page 2-39 and to the *NJ/NX-series CPU Unit Motion Control User's Manual (Cat. No. W507)*.

Refer to *I/O Entry Mappings* in the *NX-series Position Interface Units User's Manual (Cat. No. W524)* for information on using the NX-series Position Interface Units.

## Instruction Details

This section describes the instruction in detail.

### ● Master (Master Axis)

Specify the master axis with *Master*.

### ● Slave (Slave Axis)

Specify the slave axis with *Slave*.

### ● TriggerInput (Trigger Input Condition) and TriggerVariable

These variables specify the input signal on which to start synchronization when the sync start condition is set to **\_mcTriggerDetection**.

For the input signal selection and information on the timing when a trigger is generated, refer to *MC\_TouchProbe* on page 3-364.

If the **Drive Mode** is specified for *Mode* in *TriggerInput* (Trigger Input Condition), a drive input from the slave axis is used.

If the Controller Mode is specified, *TriggerVariable* is used as the trigger signal.

### ● ReferenceType (Position Type Selection)

You can select one of the following position types.

- **\_mcCommand**: Command position (value calculated in the previous task period)  
The master axis command position that was calculated in the previous task period is used for the current period.  
The command value that was calculated for the master axis in the last periodic task is used to calculate the command position of the slave axis in the current period.
- **\_mcFeedback**: Value obtained in the same task period  
The actual position of the master axis that was obtained in the same task period is used.

- \_mcLatestCommand:** Command position (value calculated in the same task period)  
 The command position of the master axis that was calculated in the same task period is used. This enables the use of information that is more recent than for `_mcCommand`. However, the axis number of the master axis must be set lower than the axis number of the slave axis. If the axis number of the slave axis is lower than the axis number of the master axis, *Error* will change to TRUE. A Master/Slave Axis Numbers Not in Ascending Order error (error code: 5438 hex) will be output to *ErrorID*.



#### Precautions for Correct Use

Here, the task period is the primary period if the task is the primary periodic task and the task period of the priority-5 periodic task if the task is the priority-5 periodic task. In the same way, the periodic task is the primary periodic task or the priority-5 periodic task.



#### Additional Information

The command position that is calculated in the same task period enables greater precision in synchronization than the command position that was calculated in the previous task period. However, the axis number set for the *Master* (Master Axis) in the system-defined variable for motion control must be lower than the axis number set for the *Slave* (Slave Axis) in the system-defined variable for motion control.

### ● Relationship between Axis Types and Position Types

The relationship between the axis types that you can monitor and position types that is monitored is shown below.

Axis Type	ReferenceType	
	<code>_mcCommand</code> or <code>_mcLatestCommand</code>	<code>_mcFeedback</code>
Servo axis	OK	OK
Encoder axis	No *1	OK
Virtual servo axis	OK	OK
Virtual encoder axis	No *1	OK

\*1. A Position Type Selection Out of Range error (error code: 5430 hex) occurs when the instruction is executed.

### ● SlaveDistance (Slave Axis Travel Distance), MasterDistance (Master Axis Travel Distance), MasterDistanceInACC (Master Distance in Acceleration), and MasterDistanceInDEC (Master Distance in Deceleration)

The velocity and position of the slave axis are determined by the ratio of the travel distances of the master axis and the slave axis as shown in the following figure.

The master following distance shown in the following figure represents the position where the sync start condition was met.

#### Master Axis Travel in Positive Direction

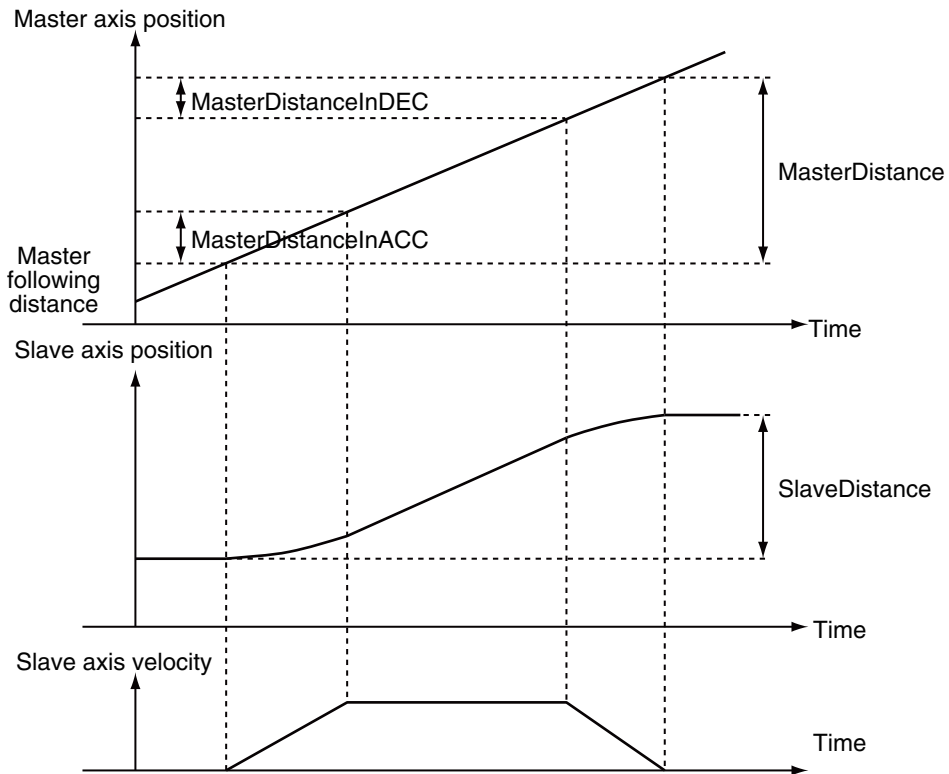

**Master Axis Travel in Negative Direction**

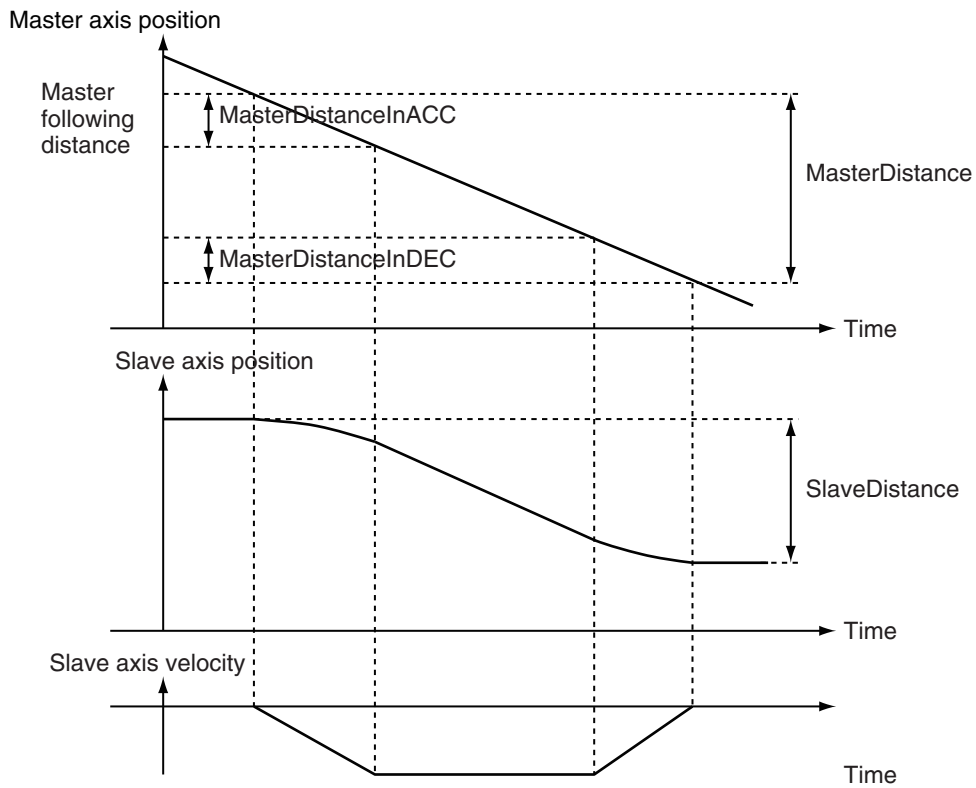

The relationship between the travel distance of the master axis and the travel distance of the slave axis is shown in the following table.

Section	Relationship between the master axis and slave axis travel distances	
Acceleration	Master axis	Master Distance in Acceleration
	Slave axis	$\text{Slave axis travel distance} \times \left( \frac{\text{Master distance in acceleration}}{2} + \frac{\text{Master distance in acceleration}}{2} + (\text{Master axis travel distance} - \text{Master distance in acceleration} - \text{Master distance in deceleration}) + \frac{\text{Master distance in deceleration}}{2} \right)$
Constant velocity	Master axis	Master axis travel distance - Master distance in acceleration - Master distance in deceleration
	Slave axis	Slave axis travel distance - Slave axis travel distance at the acceleration rate above - Slave axis travel distance at the deceleration rate below
Deceleration	Master axis	Master Distance in Deceleration
	Slave axis	$\text{Slave axis travel distance} \times \left( \frac{\text{Master distance in deceleration}}{2} + \frac{\text{Master distance in acceleration}}{2} + (\text{Master axis travel distance} - \text{Master distance in acceleration} - \text{Master distance in deceleration}) + \frac{\text{Master distance in deceleration}}{2} \right)$

When the constant velocity section of the master axis is negative, a constant velocity travel distance error occurs and the axis stops.

If you want to feed the slave axis at the same velocity as the master axis, set the following value as the travel distance of the slave axis.

$$\text{Slave axis travel distance} = \frac{\text{Master distance in acceleration}}{2} + (\text{Master axis travel distance} - \text{Master distance in acceleration} - \text{Master distance in deceleration}) + \frac{\text{Master distance in deceleration}}{2}$$



#### Precautions for Correct Use

If the counter mode for the master axis is **Rotary Mode**, specify a value that is within one ring counter cycle for *MasterDistance* (Master Axis Travel Distance).

#### ● LinkOption (Synchronization Start Condition)

Specify the condition for the slave axis to synchronize with the master axis.

- Start of Instruction

When this instruction is executed, the slave axis performs positioning in synchronization with the master axis from the next period.

- When Trigger Is Detected

When the input signal specified as the input trigger occurs, the slave axis synchronizes with the master axis and performs positioning from the next period.

- When the Master Axis Reaches the Master Following Distance

When the master axis reaches the master following distance during instruction execution, the slave axis starts synchronization and performs positioning from the next period.

Even if the instruction is executed while the master axis is stopped at the master following distance, the slave axis starts synchronization and performs positioning from the next period.



### Precautions for Correct Use

You must map object data when *LinkOption* (Synchronization Start Condition) is set to **\_mcTriggerDetection** and *Mode* is set to **Drive Mode**.

Set the following objects.

- Touch probe function (60B8 hex)
- Touch probe status (60B9 hex)
- Touch probe pos1 pos value (60BA hex)
- Touch probe pos2 pos value (60BC hex)

If even one of the required objects is not set, a Process Data Object Setting Missing error (error code 3461 hex) occurs.

For details on mapping data objects, refer to *2-3 PDO Mapping* on page 2-39 and to the *NJ/NX-series CPU Unit Motion Control User's Manual (Cat. No. W507)*.

### ● MasterStartDistance (Master Following Distance)

This variable specifies the absolute position where the slave axis starts synchronization with the master axis.

#### CPU Units with Unit Version 1.10 or Later

When the Count Mode of the master axis is **Rotary Mode**, you can specify a *MasterStartDistance* (Master Following Distance) outside the range specified by the modulo maximum position and modulo minimum position setting values. If you do, the relationship between the master axis current position and the master axis following distance will be the same as when **No direction** is specified for *Direction* in the *MC\_MoveAbsolute* (Absolute Positioning) instruction.

Refer to *MC\_MoveAbsolute* on page 3-52 for information on the *MC\_MoveAbsolute* (Absolute Positioning) instruction.

#### CPU Units with Unit Version 1.09 or Earlier

If the Count Mode for the master axis is **Rotary Mode**, specify a value that is within the range specified by the modulo maximum position and modulo minimum position setting values for *MasterStartDistance* (Master Following Distance). If the value is not within the limits, an Cam Master Axis Following First Position Setting Out of Range error (error code 547B hex) is output when the instruction is executed.

### ● BufferMode (Buffer Mode Selection)

This variable specifies how to join the axis motions for this instruction and the previous instruction.

There is currently only the following two settings.

Buffer Mode Selection	Description
Aborting	Aborts the instruction being executed and switches to this instruction.
Buffered	Automatically executes the buffered instruction after the current instruction is completed.

For details on *BufferMode* (Buffer Mode Selection), refer to the *NJ/NX-series CPU Unit Motion Control User's Manual (Cat. No. W507)*.

### ● In-position Check

An in-position check is performed when the slave axis ends operation.

An in-position check is performed for this instruction according to the settings in **In-position Range** and **In-position Check Time** axis parameters.

## Timing Charts

### ● Executing MC\_MoveLink

*LinkOption* (Synchronization Start Condition) Set to 0: `_mcCommandExecution`

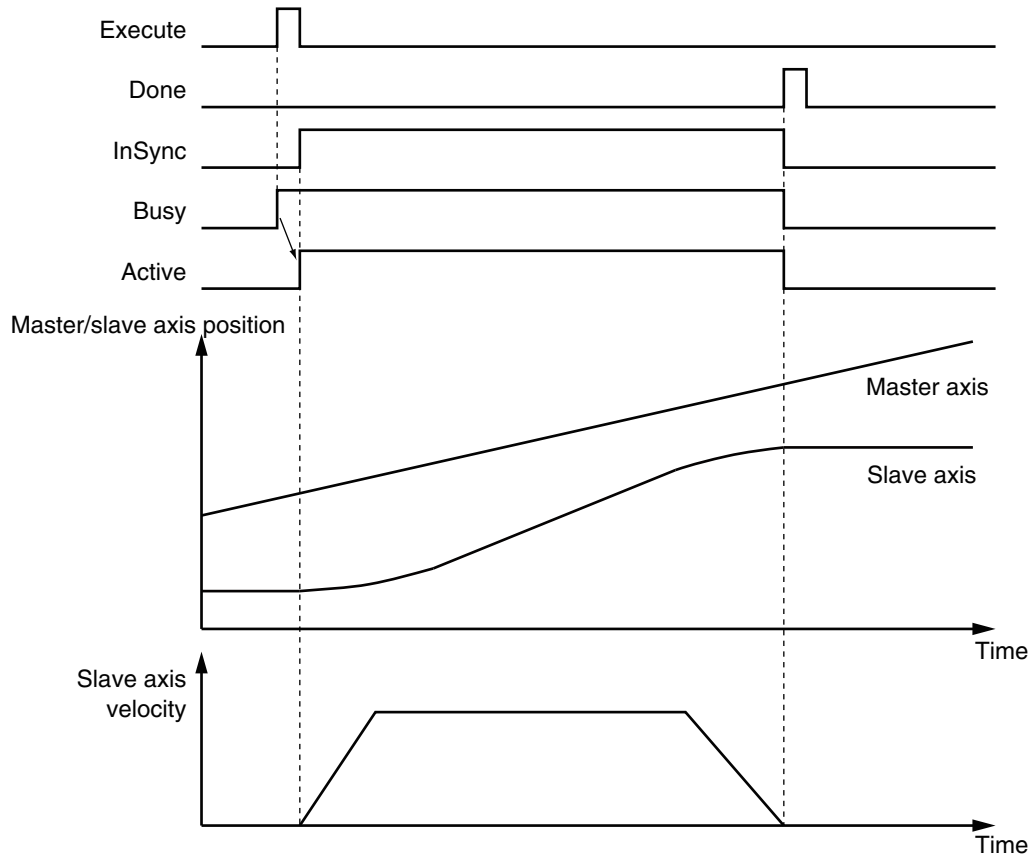

*LinkOption* (Synchronization Start Condition) Set to 1: `_mcTriggerDetection`



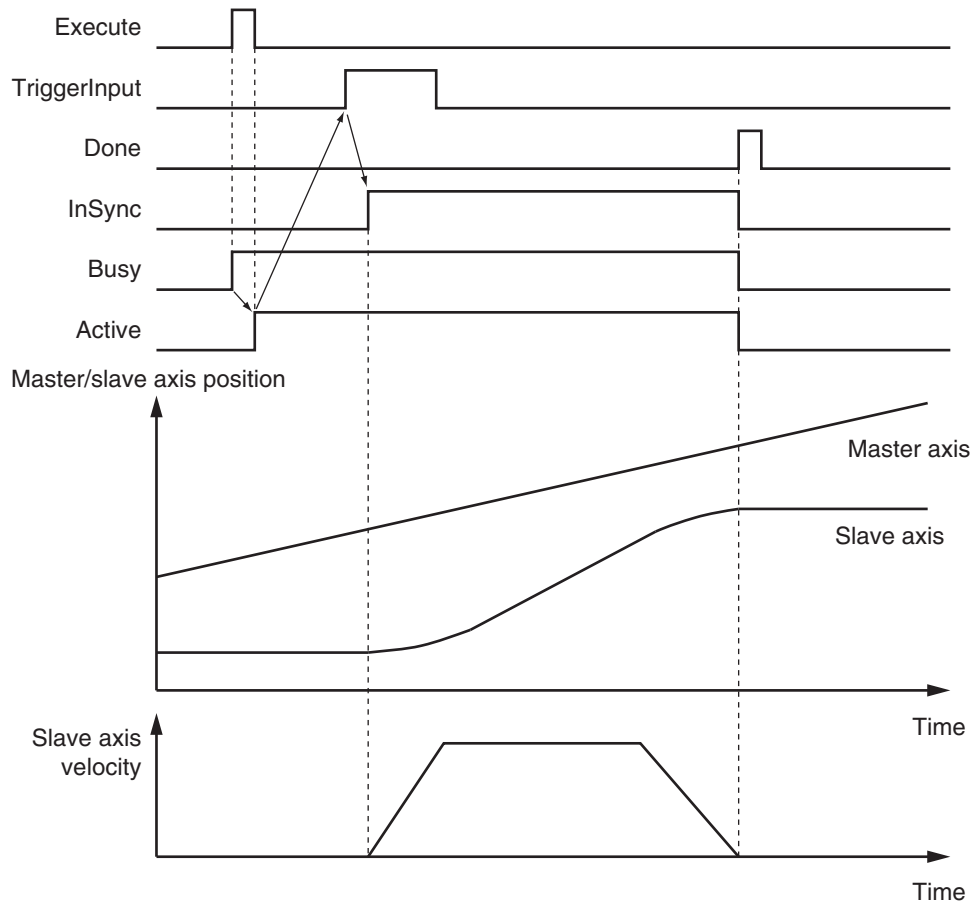

**LinkOption (Synchronization Start Condition) Set to 2: \_mcMasterReach**

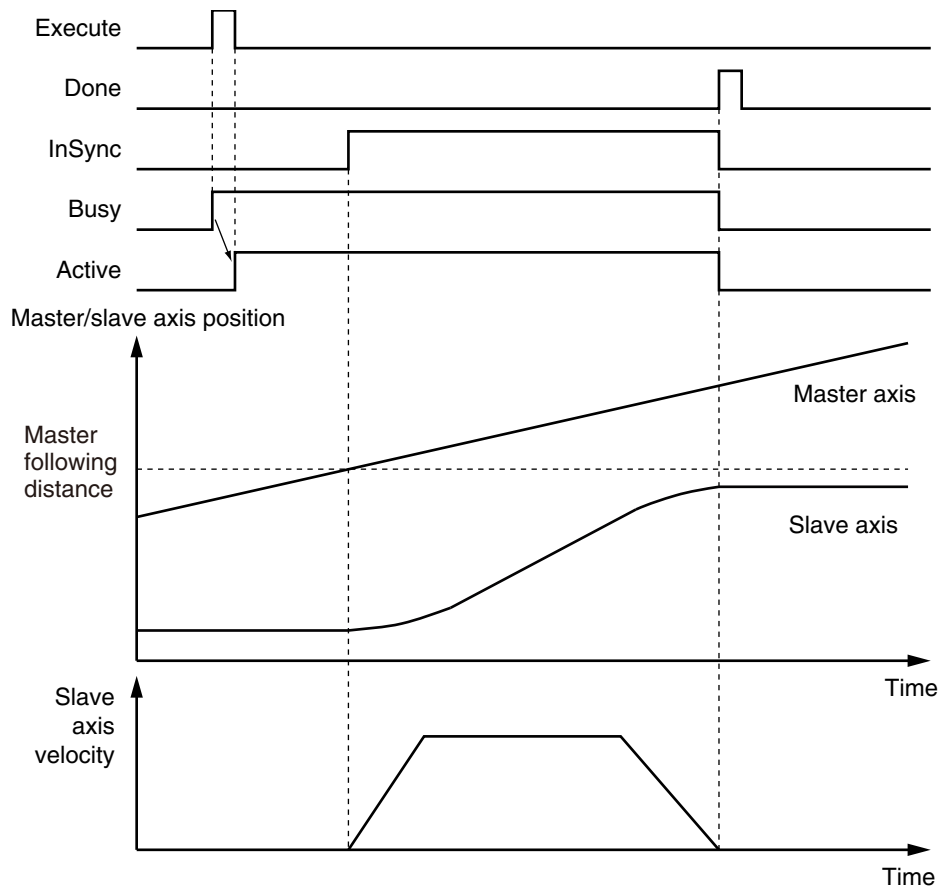

● **When an Instruction Is Executed with *BufferMode* Set to Aborting during Previous Operation**

This section describes when this instruction is executed with *LinkOption* (Synchronization Start Condition) set to **0: \_mcCommandExecution** (when instruction execution starts) while the previous operation, MC\_MoveAbsolute (Absolute Positioning), is in execution.



**Precautions for Correct Use**

As shown in the following chart, the velocity of the slave axis becomes discontinuous when this instruction is started.

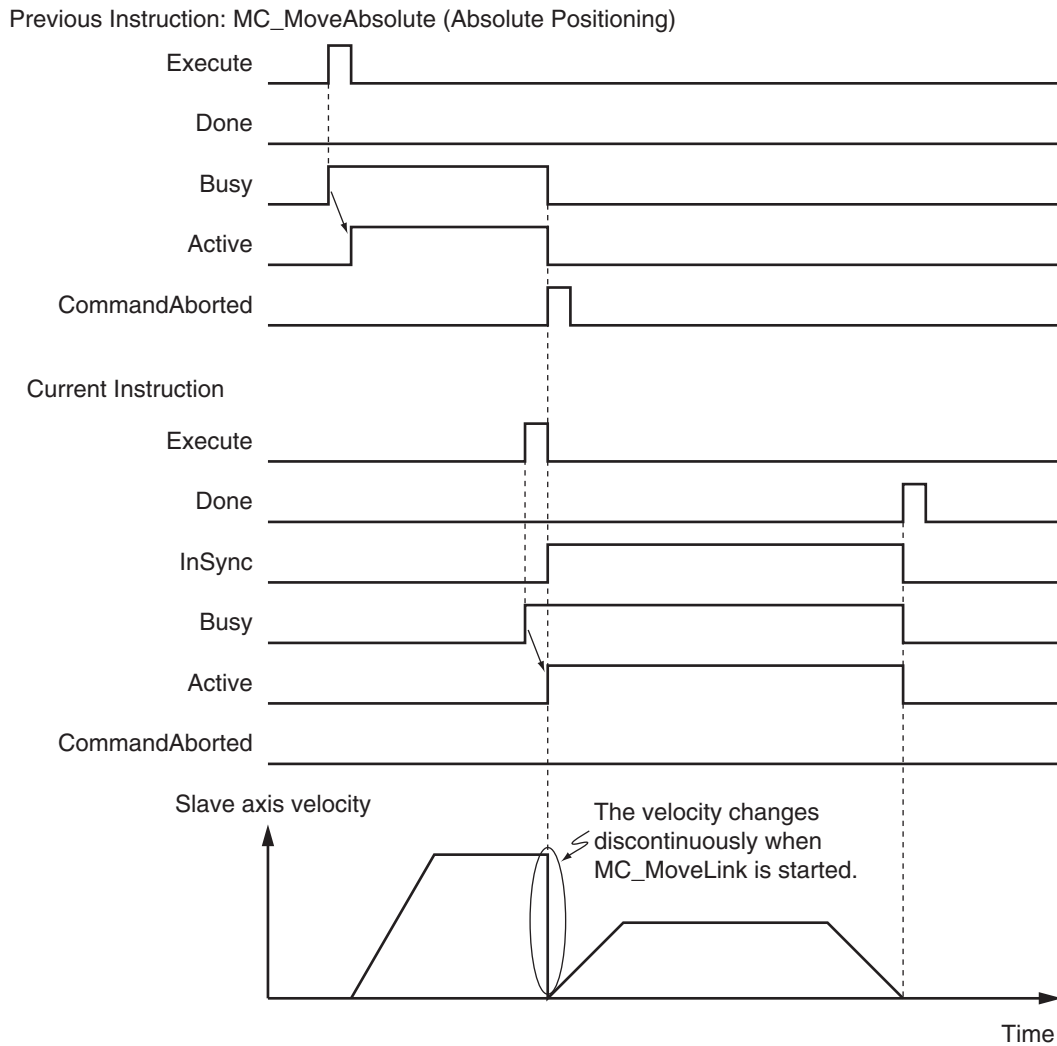

- **When an Instruction Is Executed with *BufferMode* (Buffer Mode Selection) Set to Buffered during Previous Operation**

This instruction is executed after the previous instruction is finished.

## Re-execution of Motion Control Instructions

This instruction cannot be re-executed.

A Motion Control Instruction Re-execution Disabled error (error code: 543B hex) occurs if re-execution is attempted, and the axis stops.

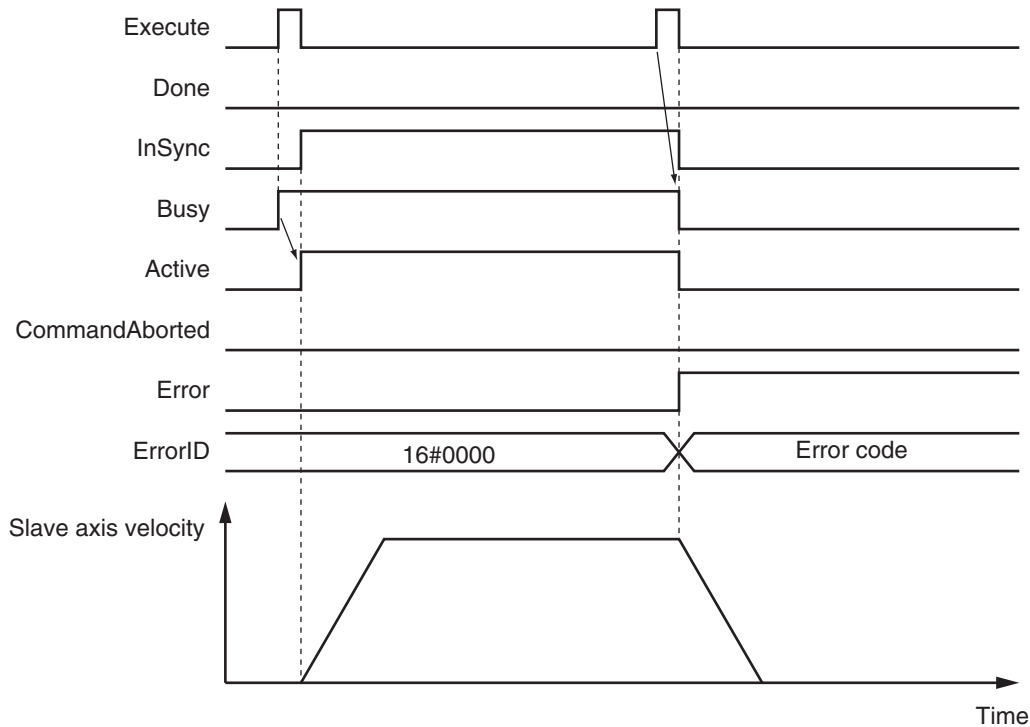

## Multi-execution of Motion Control Instructions

For details on multi-execution of motion control instructions, refer to the *NJ/NX-series CPU Unit Motion Control User's Manual (Cat. No. W507)*.

### ● Execution of Other Instructions during Instruction Execution

If you execute another instruction during execution of this instruction, you can specify either **Aborting** or **Buffering**.

You cannot specify blending.

## Errors

If an error occurs during instruction execution, *Error* will change to TRUE.

You can find out the cause of the error by referring to the value output by *ErrorID* (Error Code).

Refer to *Re-execution of Motion Control Instructions* on page 3-307 for the timing chart after an error occurs.

### ● Error Codes

Refer to the *NJ/NX-series Troubleshooting Manual (Cat. No. W503)* for instruction errors.

## Sample Programming

This sample programming shows the control of a cutter.

## Parameter Settings

The minimum settings required for this sample programming are given below.

### ● Setting Axis Parameters

#### Axis Types

Axis	Axis Type
Axis 1	Servo axis (master axis)
Axis 2	Servo axis (slave axis)

#### Count Modes

Axis	Count Mode
Axis 1	Rotary Mode
Axis 2	Linear Mode

#### Ring Counter

Axis	Modulo maximum position	Modulo minimum position
Axis 1	360	0

#### Units of Display

Axis	Unit of Display
Axis 1	degree
Axis 2	mm

## Operation Example

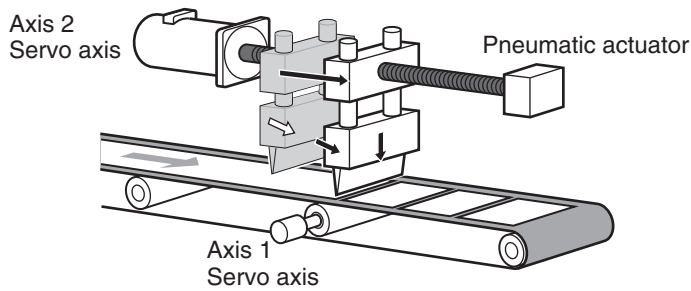

## ● Operation Patterns

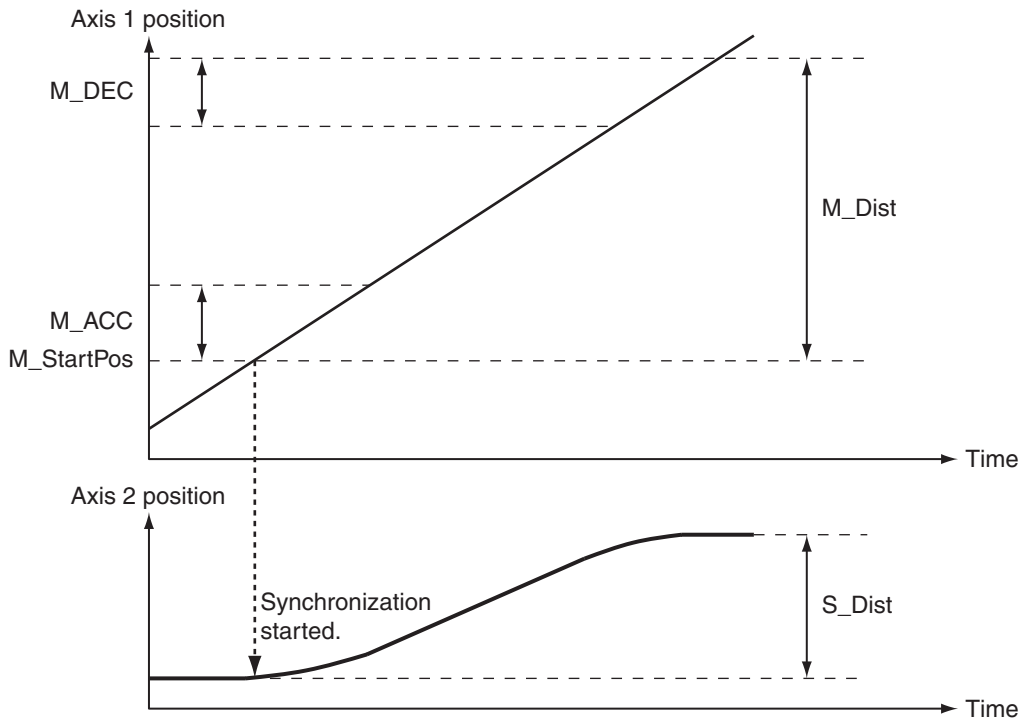

- 1** Starting the Master Axis  
Axis 1 for the belt conveyer is treated as master axis to feed back the position.
- 2** Executing the Slave Axis  
Axis 2 for the ball screw that moves in the horizontal direction moves in synchronization with axis 1.
- 3** Cutting with the Cutter  
The pneumatic actuator turns ON when axis 2 is synchronized. The cutter, which is connected to the pneumatic actuator, descends in a vertical direction and cuts the workpiece.

## Ladder Diagram

### ● Main Variables

Name	Data type	Default	Comment
MC_Axis000	_sAXIS_REF	---	Axis Variable for the master axis, axis 1.
MC_Axis000.MFaultLvl.Active	BOOL	FALSE	TRUE while there is a minor fault level error for axis 1.
MC_Axis000.Details.Homed	BOOL	FALSE	TRUE when home is defined for axis 1.
MC_Axis001	_sAXIS_REF	---	Axis Variable for the slave axis, axis 2.
MC_Axis001.MFaultLvl.Active	BOOL	FALSE	TRUE while there is a minor fault level error for axis 2.
MC_Axis001.Details.Homed	BOOL	FALSE	TRUE when home is defined for axis 2.

Name	Data type	Default	Comment
Pwr1_Status	BOOL	FALSE	This variable is assigned to the <i>Status</i> output variable from the PWR1 instance of the MC_Power instruction. This variable changes to TRUE when the Servo is turned ON.
Pwr2_Status	BOOL	FALSE	This variable is assigned to the <i>Status</i> output variable from the PWR2 instance of the MC_Power instruction. This variable changes to TRUE when the Servo is turned ON.
StartPg	BOOL	FALSE	The Servo is turned ON if this variable is TRUE and EtherCAT process data communications are established.
Actuator	BOOL	FALSE	TRUE when axis 1 and axis 2 are synchronized. While <i>Actuator</i> is TRUE, the cutter moves down vertically.
InitFlag	BOOL	FALSE	This variable indicates if it is necessary to set the input parameters. Input parameters are set when this variable is FALSE. When setting the input parameters is completed, this variable changes to TRUE.

● Timing Chart

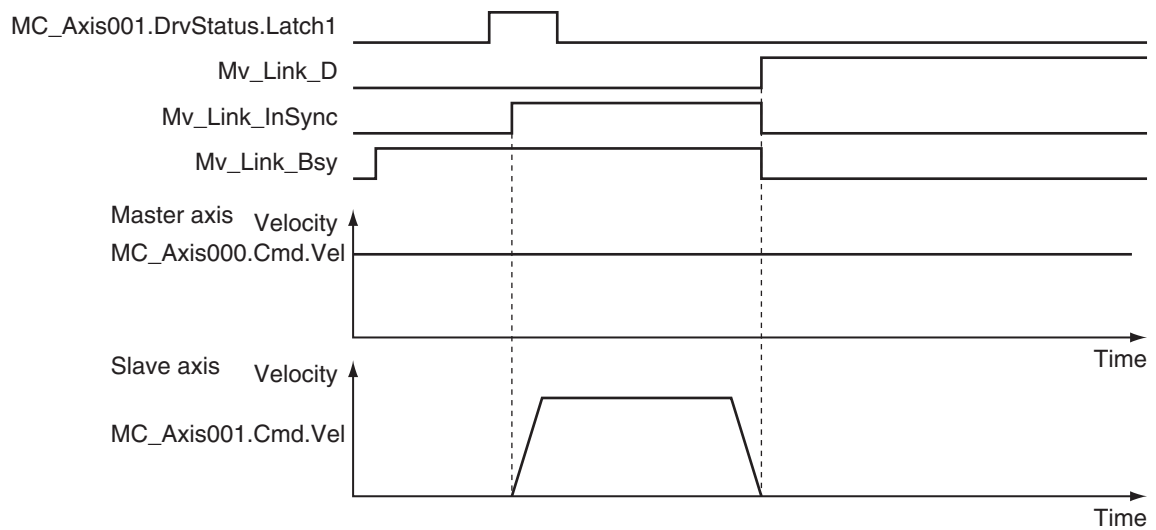

● Sample Programming

If *StartPg* is TRUE, check that the Servo Drives for each axis are ready.

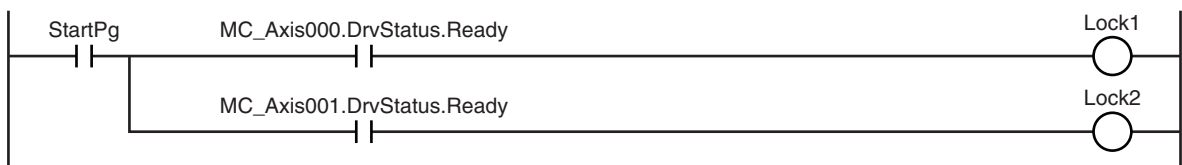

If the Servo Drives are ready, the Servos are turned ON for each axis.

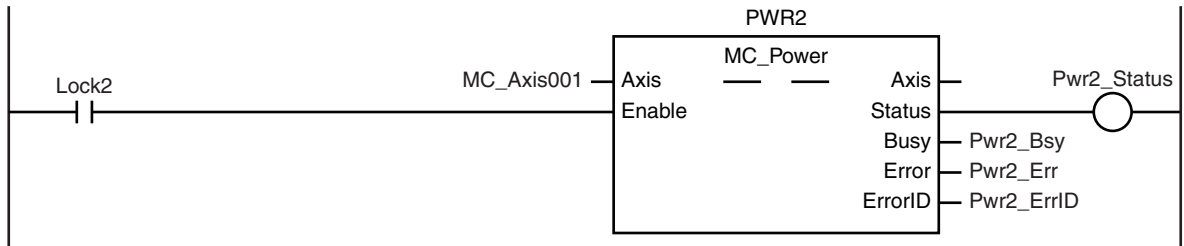
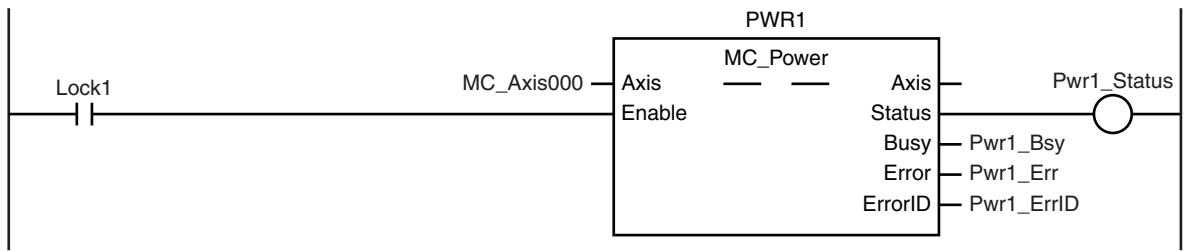

If a minor fault level error occurs for the axis composition, the error handler for the device (FaultHandler) is executed.  
Program the FaultHandler according to the device.

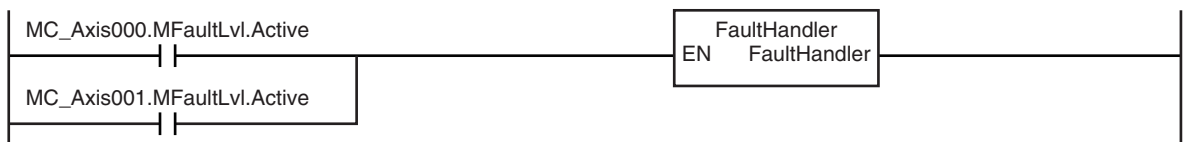

If the Servo is ON for axis 1 and home is not defined, the Home instruction is executed to define home.

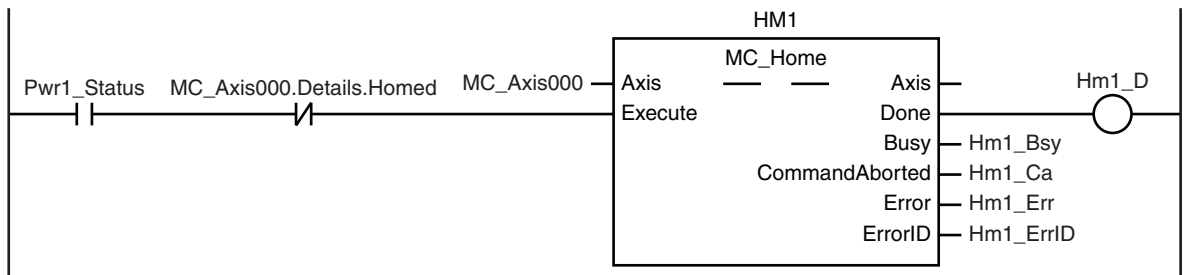

If the Servo is ON for axis 2 and home is not defined, the Home instruction is executed to define home.

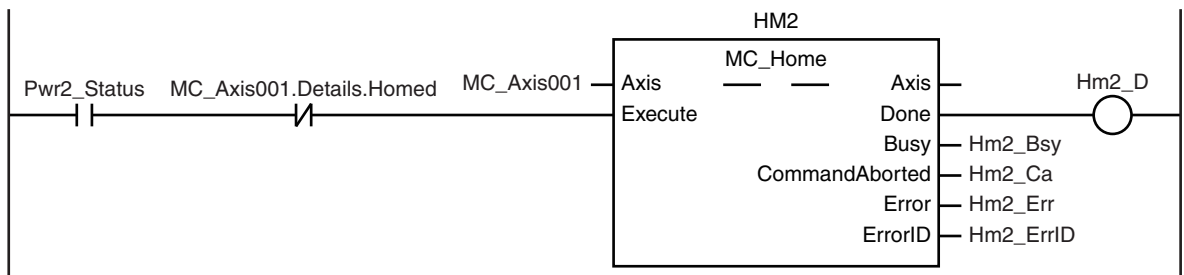



The parameters are set for the MC\_MoveVelocity (Velocity Control) and MC\_MoveLink (Synchronous Positioning) instructions.

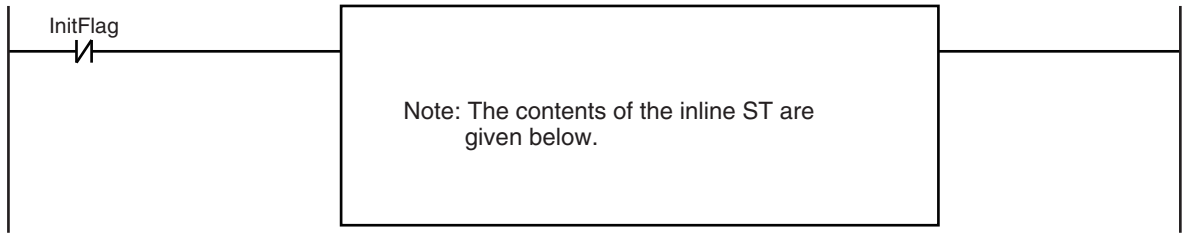

The MC\_MoveVelocity (Velocity Control) instruction is executed if home is defined for axis 1.

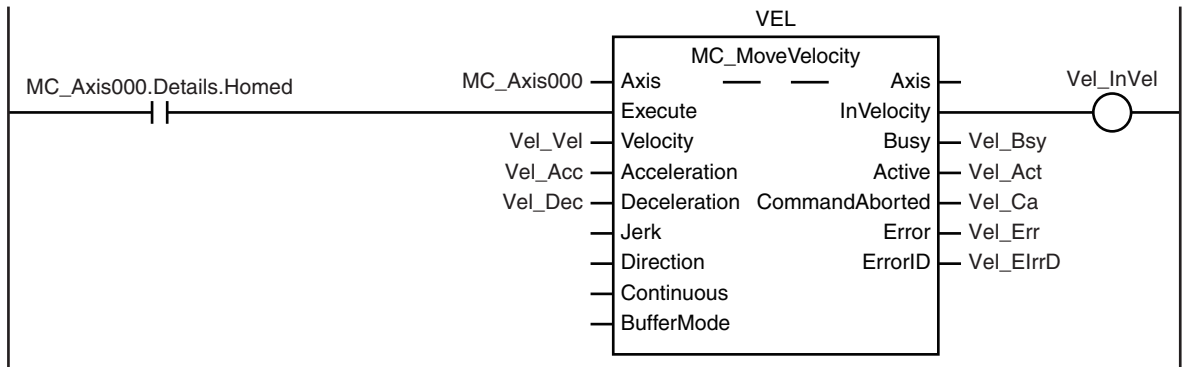

The MC\_MoveLink (Synchronous Positioning) instruction is executed if home is defined for axis 2 (slave axis).

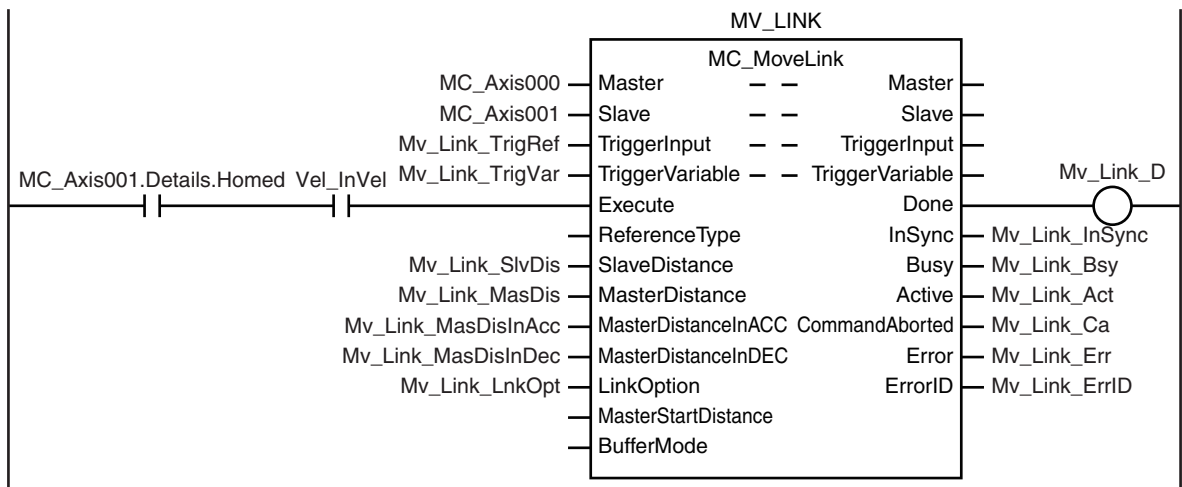

Actuator is TRUE while the axes are synchronized.

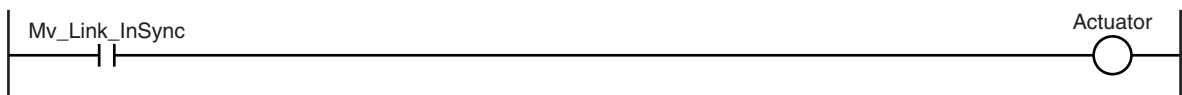

**Contents of Inline ST**

```
// MC_MoveVelocity parameters
Vel_Vel := LREAL#1000.0;
Vel_Acc := LREAL#0.0;
Vel_Dec := LREAL#0.0;

// MC_MoveLink parameters
```

```

Mv_Link_TrigRef.Mode := _eMC_TRIGGER_MODE#_mcDrive;
Mv_Link_TrigRef.LatchID := _eMC_TRIGGER_LATCH_ID#_mcLatch1;
Mv_Link_TrigRef.InputDrive := _eMC_TRIGGER_INPUT_DRIVE#_mcEXT;
Mv_Link_TrigVar := FALSE;
Mv_Link_SlvDis := LREAL#1000.0;
Mv_Link_MasDis := LREAL#1000.0;
Mv_Link_MasDisInAcc := LREAL#100.0;
Mv_Link_MasDisInDec := LREAL#100.0;
Mv_Link_LnkOpt := _eMC_LINKOPTION#_mcTriggerDetection;

// Change InitFlag to TRUE after setting the input parameters.
InitFlag := TRUE;

```

## Structured Text (ST)

### ● Main Variables

Name	Data type	Default	Comment
MC_Axis000	_sAXIS_REF	---	Axis Variable for the master axis, axis 1.
MC_Axis000.MFaultLvl.Active	BOOL	FALSE	TRUE while there is a minor fault level error for axis 1.
MC_Axis000.Details.Homed	BOOL	FALSE	TRUE when home is defined for axis 1.
MC_Axis001	_sAXIS_REF	---	Axis Variable for the slave axis, axis 2.
MC_Axis001.MFaultLvl.Active	BOOL	FALSE	TRUE while there is a minor fault level error for axis 2.
MC_Axis001.Details.Homed	BOOL	FALSE	TRUE when home is defined for axis 2.
Pwr1_Status	BOOL	FALSE	This variable is assigned to the <i>Status</i> output variable from the PWR1 instance of the MC_Power instruction. This variable changes to TRUE when the Servo is turned ON.
Pwr2_Status	BOOL	FALSE	This variable is assigned to the <i>Status</i> output variable from the PWR2 instance of the MC_Power instruction. This variable changes to TRUE when the Servo is turned ON.
StartPg	BOOL	FALSE	The Servo is turned ON if this variable is TRUE and EtherCAT process data communications are established.
Actuator	BOOL	FALSE	TRUE when axis 1 and axis 2 are synchronized. While <i>Actuator</i> is TRUE, the cutter moves down vertically.
InitFlag	BOOL	FALSE	This variable indicates if it is necessary to set the input parameters. Input parameters are set when this variable is FALSE. When setting the input parameters is completed, this variable changes to TRUE.

## ● Timing Chart

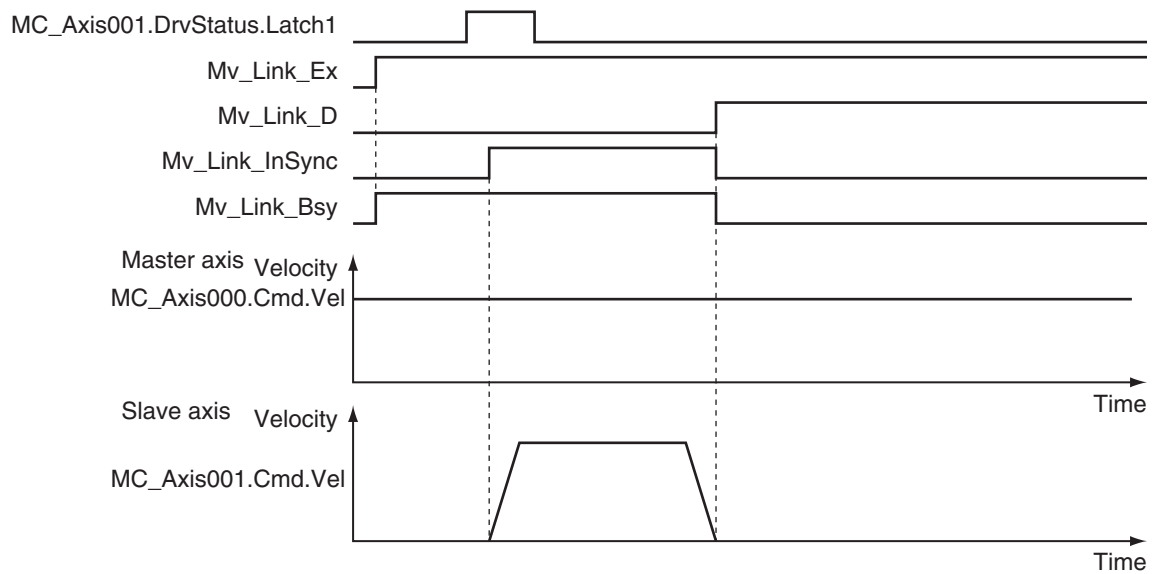

## ● Sample Programming

```
// Processing when input parameters are not set
IF InitFlag=FALSE THEN

    // MC_MoveVelocity parameters
    Vel_Vel := LREAL#1000.0;
    Vel_Acc := LREAL#0.0;
    Vel_Dec := LREAL#0.0;

    // MC_MoveLink parameters
    Mv_Link_TrigRef.Mode := _eMC_TRIGGER_MODE#_mcDrive;
    Mv_Link_TrigRef.LatchID := _eMC_TRIGGER_LATCH_ID#_mcLatch1;
    Mv_Link_TrigRef.InputDrive := _eMC_TRIGGER_INPUT_DRIVE#_mcEXT;
    Mv_Link_TrigVar := FALSE;
    Mv_Link_SlvDis := LREAL#1000.0;
    Mv_Link_MasDis := LREAL#1000.0;
    Mv_Link_MasDisInAcc := LREAL#100.0;
    Mv_Link_MasDisInDec := LREAL#100.0;
    Mv_Link_LnkOpt := _eMC_LINKOPTION#_mcTriggerDetection;

    // Change InitFlag to TRUE after setting the input parameters.
    InitFlag := TRUE;

END_IF;

// If StartPg is TRUE and the Servo Drive is ready, the Servo for axis 1 is turned
ON.
// If the Servo Drive is not ready, the Servo is turned OFF.
IF (StartPg=TRUE)
```

```
    AND (MC_Axis000.DrvStatus.Ready=TRUE) THEN
        Pwr1_En:=TRUE; // Turn ON the Servo for axis 1.
ELSE
    Pwr1_En:=FALSE; // Turn OFF the Servo for axis 1.
END_IF;

// If StartPg is TRUE and the Servo Drive is ready, the Servo for axis 2 is turned
ON.
// If the Servo Drive is not ready, the Servo is turned OFF.
IF (StartPg=TRUE)
    AND (MC_Axis001.DrvStatus.Ready=TRUE) THEN
        Pwr2_En:=TRUE; // Turn ON the Servo for axis 2.
ELSE
    Pwr2_En:=FALSE; // Turn OFF the Servo for axis 2.
END_IF;

// Processing for a minor fault level error
// Program the FaultHandler according to the device.
IF (MC_Axis000.MFaultLvl.Active=TRUE) OR (MC_Axis001.MFaultLvl.Active=TRUE) THEN
    FaultHandler();
END_IF;

// If the Servo is ON for axis 1 and home is not defined, the Home instruction is e
xecuted.
IF (Pwr1_Status=TRUE) AND (MC_Axis000.Details.Homed=FALSE) THEN
    Hm1_Ex:=TRUE;
END_IF;

// If the Servo is ON for axis 2 and home is not defined, the Home instruction is e
xecuted.
IF (Pwr2_Status=TRUE) AND (MC_Axis001.Details.Homed=FALSE) THEN
    Hm2_Ex:=TRUE;
END_IF;

// After home is defined for axis 1, MC_MoveVelocity is executed for axis 1.
IF MC_Axis000.Details.Homed=TRUE THEN
    Vel_Ex:=TRUE;
END_IF;

// MC_MoveLink is executed for axis 2 if home is defined for axis 2 and the target
velocity was reached for axis 1.
IF (MC_Axis001.Details.Homed=TRUE) AND (Vel_InVel=TRUE) THEN
    Mv_Link_Ex:=TRUE;
END_IF;

// The actuator is turned ON if axis 1 and axis 2 are synchronized.
IF Mv_Link_InSync=TRUE THEN
```

```

    Actuator:=TRUE;
ELSE
    Actuator:=FALSE;
END_IF;

// MC_Power1
PWR1 (
    Axis := MC_Axis000,
    Enable := Pwr1_En,
    Status => Pwr1_Status,
    Busy => Pwr1_Bsy,
    Error => Pwr1_Err,
    ErrorID => Pwr1_ErrID
);

// MC_Power2
PWR2 (
    Axis := MC_Axis001,
    Enable := Pwr2_En,
    Status => Pwr2_Status,
    Busy => Pwr2_Bsy,
    Error => Pwr2_Err,
    ErrorID => Pwr2_ErrID
);

// MC_Home1
HM1 (
    Axis := MC_Axis000,
    Execute := Hm1_Ex,
    Done => Hm1_D,
    Busy => Hm1_Bsy,
    CommandAborted => Hm1_Ca,
    Error => Hm1_Err,
    ErrorID => Hm1_ErrID
);

// MC_Home2
HM2 (
    Axis := MC_Axis001,
    Execute := Hm2_Ex,
    Done => Hm2_D,
    Busy => Hm2_Bsy,
    CommandAborted => Hm2_Ca,
    Error => Hm2_Err,
    ErrorID => Hm2_ErrID
);

```

```
// MC_MoveVelocity
VEL(
    Axis := MC_Axis000,
    Execute := Vel_Ex,
    Velocity := Vel_Vel,
    Acceleration := Vel_Acc,
    Deceleration := Vel_Dec,
    InVelocity => Vel_InVel,
    Busy => Vel_Bsy,
    Active => Vel_Act,
    CommandAborted => Vel_Ca,
    Error => Vel_Err,
    ErrorID => Vel_ErrID
);

// MC_MoveLink
MV_LINK(
    Master := MC_Axis000,
    Slave := MC_Axis001,
    TriggerInput := Mv_Link_TrigRef,
    TriggerVariable := Mv_Link_TrigVar,
    Execute := Mv_Link_Ex,
    SlaveDistance := Mv_Link_SlvDis,
    MasterDistance := Mv_Link_MasDis,
    MasterDistanceInAcc := Mv_Link_MasDisInAcc,
    MasterDistanceInDec := Mv_Link_MasDisInDec,
    LinkOption := Mv_Link_LnkOpt,
    Done => Mv_Link_D,
    InSync => Mv_Link_InSync,
    Busy => Mv_Link_Bsy,
    Active => Mv_Link_Act,
    CommandAborted => Mv_Link_Ca,
    Error => Mv_Link_Err,
    ErrorID => Mv_Link_ErrID
);
```

# MC\_CombineAxes

The MC\_CombineAxes instruction outputs the sum or difference of the command positions of two axes as the command position.

Instruction	Name	FB/ FUN	Graphic expression	ST expression
MC_CombineAxes	Combine Axes	FB		<pre>MC_CombineAxes_instance (   Master :=parameter,   Auxiliary :=parameter,   Slave :=parameter,   Execute :=parameter,   CombineMode :=parameter,   RatioNumeratorMaster :=parameter,   RatioDenominatorMaster :=parameter,   RatioNumeratorAuxiliary :=parameter,   RatioDenominatorAuxiliary :=parameter,   ReferenceTypeMaster :=parameter,   ReferenceTypeAuxiliary :=parameter,   BufferMode :=parameter,   InCombination =&gt;parameter,   Busy =&gt;parameter,   Active =&gt;parameter,   CommandAborted =&gt;parameter,   Error =&gt;parameter,   ErrorID =&gt;parameter );</pre>

## Variables

### Input Variables

Name	Meaning	Data type	Valid range	Default	Description
Execute	Execute	BOOL	TRUE or FALSE	FALSE	The instruction is executed when the value of this variable changes to TRUE.
CombineMode	Combine Mode	_eMC_COMBINE_MODE	0: _mcAddAxes 1: _mcSubAxes	0*1	Specify the combining method. 0: Addition 1: Subtraction
RatioNumeratorMaster (Reserved)	Master Axis Gear Ratio Numerator	DINT*2	Positive or negative number*2	10000	(Reserved)
RatioDenominatorMaster (Reserved)	Master Axis Gear Ratio Denominator	UDINT*3	Positive number	10000	(Reserved)

Name	Meaning	Data type	Valid range	Default	Description
RatioNumeratorAuxiliary (Reserved)	Auxiliary Axis Gear Ratio Numerator	DINT* <sup>2</sup>	Positive or negative number* <sup>2</sup>	10000	(Reserved)
RatioDenominatorAuxiliary (Reserved)	Auxiliary Axis Gear Ratio Denominator	UDINT* <sup>3</sup>	Positive number	10000	(Reserved)
ReferenceTypeMaster	Master Axis Position Type Selection	_eMC_REFERENCE_TYPE	1: _mcFeedback 2: _mcLatestCommand	2* <sup>1</sup>	Specify the position type of the master axis. 1: Actual position (value obtained in the same task period* <sup>4</sup> ) 2: Command position (value calculated in the same task period* <sup>4</sup> )
ReferenceTypeAuxiliary	Auxiliary Axis Position Type Selection	_eMC_REFERENCE_TYPE	1: _mcFeedback 2: _mcLatestCommand	2* <sup>1</sup>	Specify the position type of the auxiliary axis. 1: Actual position (value obtained in the same task period* <sup>4</sup> ) 2: Command position (value calculated in the same task period* <sup>4</sup> )
BufferMode	Buffer Mode Selection	_eMC_BUFFER_MODE	0: _mcAborting	0* <sup>1</sup>	Specify the behavior when executing more than one motion instruction. 0: Aborting

- \*1. The default value for an enumeration variable is actually not the number, but the enumerator.
- \*2. A CPU Unit with unit version 1.02 or later and Sysmac Studio version 1.03 or higher are required to use this variable. For any previous version combinations, the data type is UINT and the valid range is positive numbers.
- \*3. A CPU Unit with unit version 1.02 or later and Sysmac Studio version 1.03 or higher are required to use this variable. For any previous version combinations, the data type is UINT.
- \*4. The task period is the primary period if the task is the primary periodic task and the task period of the priority-5 periodic task if the task is the priority-5 periodic task.

## Output Variables

Name	Meaning	Data type	Valid range	Description
InCombination	Axes Combined	BOOL	TRUE or FALSE	TRUE when axes are combined.
Busy	Executing	BOOL	TRUE or FALSE	TRUE when the instruction is acknowledged.
Active	Controlling	BOOL	TRUE or FALSE	TRUE when the axis is being controlled.
CommandAborted	Command Aborted	BOOL	TRUE or FALSE	TRUE when the instruction is aborted.
Error	Error	BOOL	TRUE or FALSE	TRUE while there is an error.



Name	Meaning	Data type	Valid range	Description
ErrorID	Error Code	WORD	*1	Contains the error code when an error occurs. A value of 16#0000 indicates normal execution.

\*1. The upper four digits of the event code give the error code for ErrorID. Refer to the *NJ/NX-series Troubleshooting Manual (Cat. No. W503)* for the event codes.

### ● Output Variable Update Timing

Name	Timing for changing to TRUE	Timing for changing to FALSE
InCombination	When combining axes is started.	<ul style="list-style-type: none"> <li>When <i>Error</i> changes to TRUE.</li> <li>When <i>CommandAborted</i> changes to TRUE.</li> </ul>
Busy	When <i>Execute</i> changes to TRUE.	<ul style="list-style-type: none"> <li>When <i>Error</i> changes to TRUE.</li> <li>When <i>CommandAborted</i> changes to TRUE.</li> </ul>
Active	When the instruction is started.	<ul style="list-style-type: none"> <li>When <i>Error</i> changes to TRUE.</li> <li>When <i>CommandAborted</i> changes to TRUE.</li> </ul>
CommandAborted	<ul style="list-style-type: none"> <li>When this instruction is aborted because another motion control instruction was executed with the Buffer Mode set to <b>Aborting</b>.</li> <li>When this instruction is canceled due to an error.</li> <li>When this instruction is executed while there is an error.</li> <li>When you start this instruction during MC_Stop instruction execution.</li> </ul>	<ul style="list-style-type: none"> <li>When <i>Execute</i> is TRUE and changes to FALSE.</li> <li>After one period when <i>Execute</i> is FALSE.</li> </ul>
Error	When there is an error in the execution conditions or input parameters for the instruction.	When the error is cleared.

## In-Out Variables

Name	Meaning	Data type	Valid range	Description
Master	Master Axis	_sAXIS_REF	---	Specify the master axis. *1
Auxiliary	Auxiliary Axis	_sAXIS_REF	---	Specify the auxiliary axis. *1
Slave	Slave Axis	_sAXIS_REF	---	Specify the slave axis. *1

\*1. Specify a user-defined Axis Variable that was created in the Axis Basic Settings of the Sysmac Studio (default: MC\_Axis\*) or a system-defined axis variable name (\_MC\_AX[\*], \_MC1\_AX[\*], or \_MC2\_AX[\*]).

If you use Sysmac Studio version 1.29 or higher, you can specify the system-defined axis variable name for AT specification of a user-defined variable. This will allow you to specify the user-defined variable.

If you use Sysmac Studio version 1.28 or lower, do not specify any user-defined variable created in the variable table.



### Precautions for Correct Use

One of the following minor faults will occur if the different axes are not used for the master, slave, and auxiliary axes.

- Master and Slave Defined as Same Axis (error code 5436 hex)
- Master and Auxiliary Defined as Same Axis (error code 5437 hex)
- Auxiliary and Slave Defined as Same Axis (error code 548E hex)

## Function

- The MC\_CombineAxes instruction starts combining axes when *Execute* changes to TRUE.



### Precautions for Correct Use

Do not execute the MC\_SetPosition instruction for the *Master* (Master Axis) if you use this instruction on a CPU Unit with unit version 1.09 or earlier. If the MC\_SetPosition instruction is executed for the *Master* (Master Axis), the *Slave* (Slave Axis) may follow the master axis quickly.

If you want to use the MC\_SetPosition instruction for the *Master* (Master Axis), disable the relationship between the *Master* (Master Axis) and *Slave* (Slave Axis) before executing the instruction.

Refer to *1-1-3 Precautions for Master and Auxiliary Axes in Synchronized Control* on page 1-6 for precautions on the master axis.

This precaution also applies to *Auxiliary* (Auxiliary Axis) in the same way as for *Master* (Master Axis).

## Instruction Details

From the starting point, the relative value of the *Auxiliary* (Auxiliary Axis) position is added to or subtracted from the relative value of the *Master* (Master Axis) position and is output as a relative value for the *Slave* (Slave Axis) command position.

- Adding or subtracting the position is performed as numerical operations without considering the Unit of Display for the axis in the axis parameters.
- Execute the MC\_Stop instruction to end this instruction.



### Precautions for Correct Use

Depending on the values for the *Master* (Master Axis) and *Auxiliary* (Auxiliary Axis), the travel distance, velocity, and acceleration of the *Slave* (Slave Axis) can change rapidly.

Use this setting with care.

### ● **CombineMode Set to 0: \_mcAddAxes**

*Slave* (Slave Axis) position = *Master* (Master Axis) position (relative position) + *Auxiliary* (Auxiliary Axis) position (relative position)

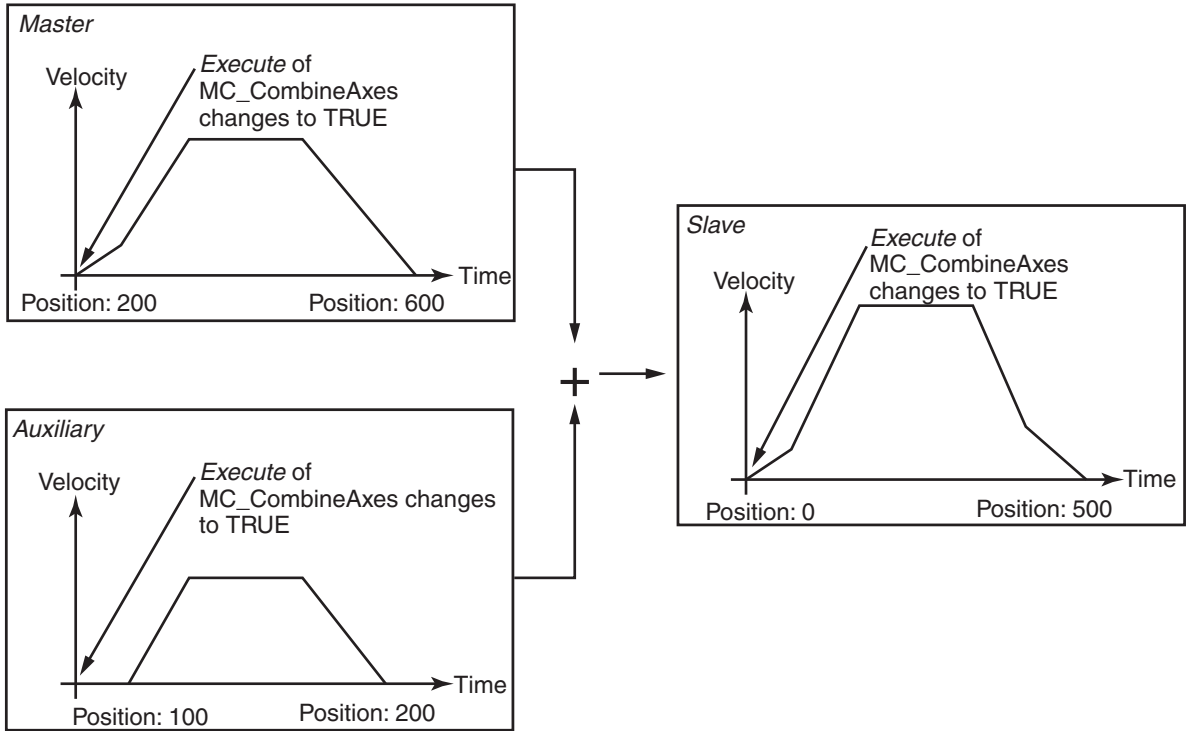

● **CombineMode Set to 1: \_mcSubAxes**

Slave (Slave Axis) position = Master (Master Axis) position (relative position) - Auxiliary (Auxiliary Axis) position (relative position)

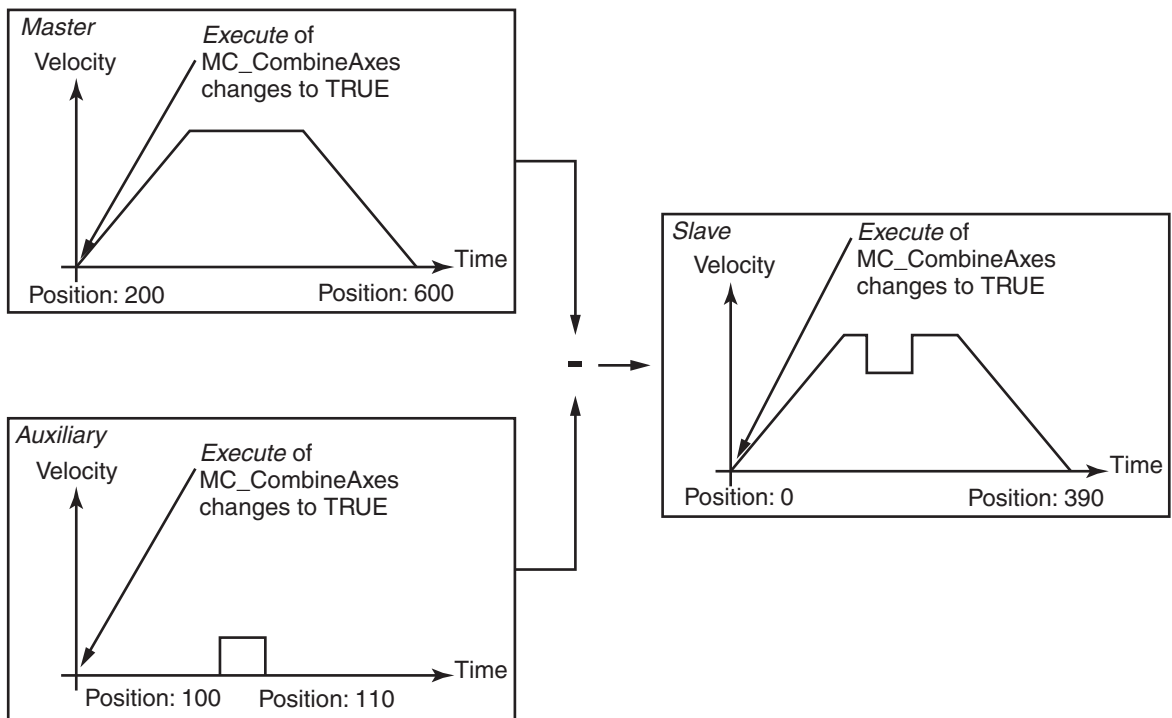

● **In-position Check**

An in-position check is not performed for this instruction.

## ● Override Factors

You cannot set override factors with the MC\_SetOverride (Set Override Factors) instruction for this instruction.

## ● ReferenceType (Position Type Selection)

You can select one of the following position types.

- `_mcFeedback`: Value obtained in the same task period  
The actual position of the master axis that was obtained in the same task period is used.
- `_mcLatestCommand`: Command position (value calculated in the same task period)  
The command position of the master axis that was calculated in the same task period is used. However, if `_mcLatestCommand` is selected, the axis numbers of the master axis and auxiliary axis must be set lower than the axis number of the slave axis.

If the axis number of the slave axis is lower than the axis numbers of the master axis or auxiliary axis, *Error* will change to TRUE. A Master/Slave Axis Numbers Not in Ascending Order error (error code: 5438 hex) will be output to *ErrorID*.

There are no restrictions in the relationship of the axis numbers between the master axis and the auxiliary axis.



### Precautions for Correct Use

Here, the task period is the primary period if the task is the primary periodic task and the task period of the priority-5 periodic task if the task is the priority-5 periodic task. In the same way, the periodic task is the primary periodic task or the priority-5 periodic task.

## ● Relationship between Axis Types and Position Types

The relationship between the axis types that you can monitor and position types that is monitored is shown below.

Axis Type	ReferenceType	
	<code>_mcFeedback</code>	<code>_mcLatestCommand</code>
Servo axis	OK	OK
Encoder axis	OK	No* <sup>1</sup>
Virtual servo axis	OK	OK
Virtual encoder axis	OK	No* <sup>1</sup>

\*1. A Position Type Selection Out of Range error (error code: 5430 hex) occurs when the instruction is executed.

## Timing Charts

- *Busy* (Executing) changes to TRUE at the same time as *Execute* changes to TRUE. *Active* (Controlling) changes to TRUE in the next period.
- *InCombination* (Axes Combined) changes to TRUE in the period where the combined output starts.
- If another instruction aborts this instruction, *CommandAborted* changes to TRUE and *Busy* (Executing), *Active* (Controlling), and *InCombination* (Axes Combined) change to FALSE.

● **CombineMode Set to 0: \_mcAddAxes**

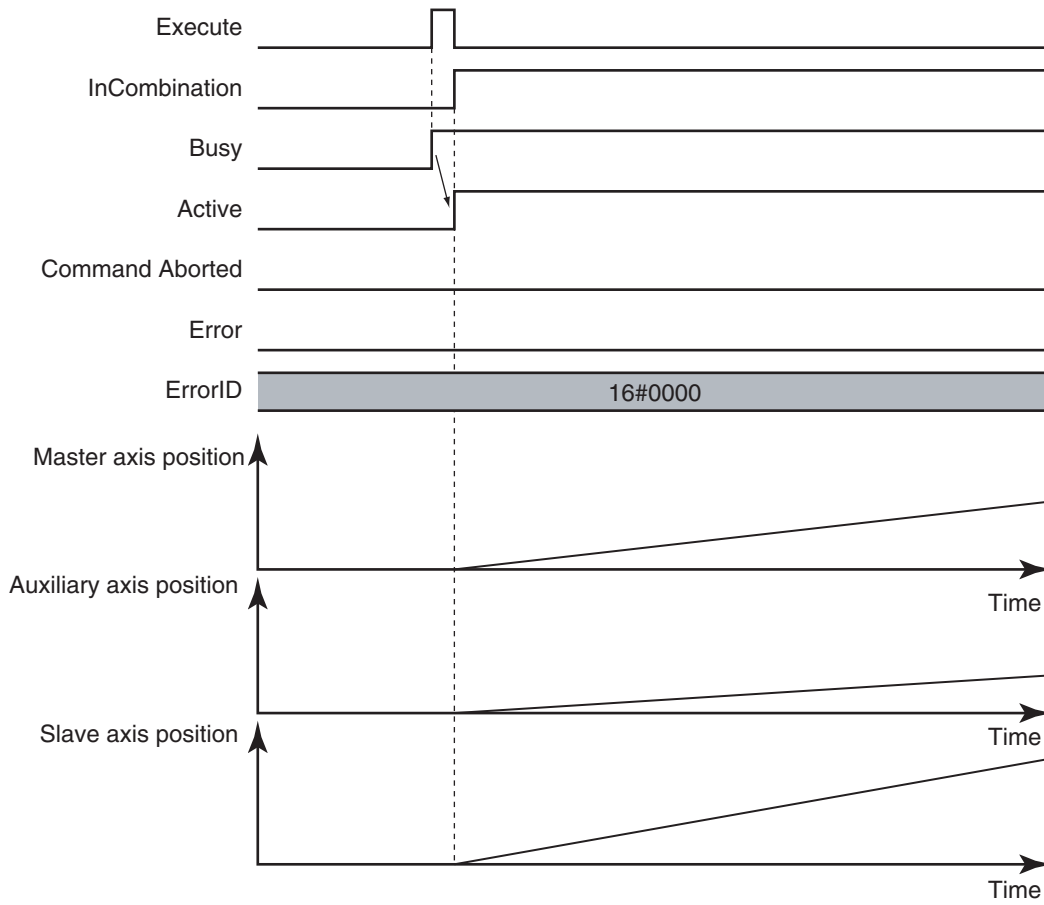

● **CombineMode Set to 1: \_mcSubAxes**

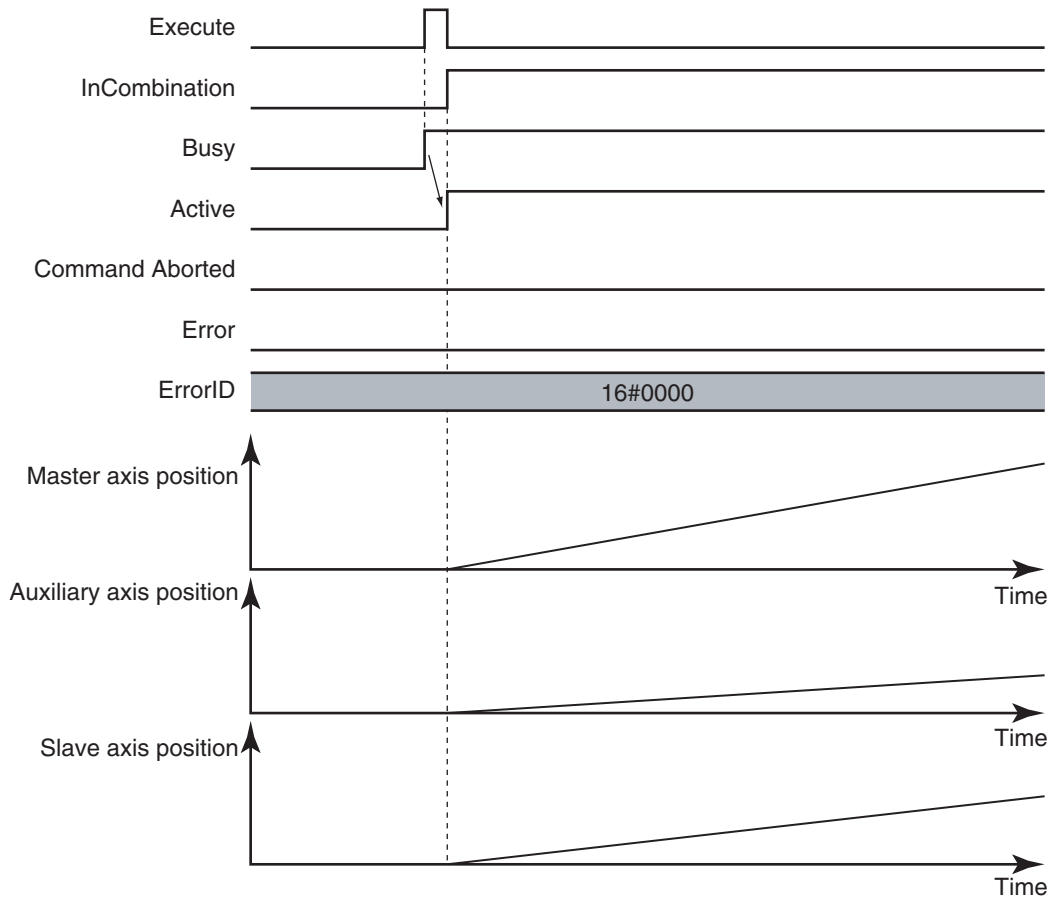

### ● When the Instruction Is Aborted

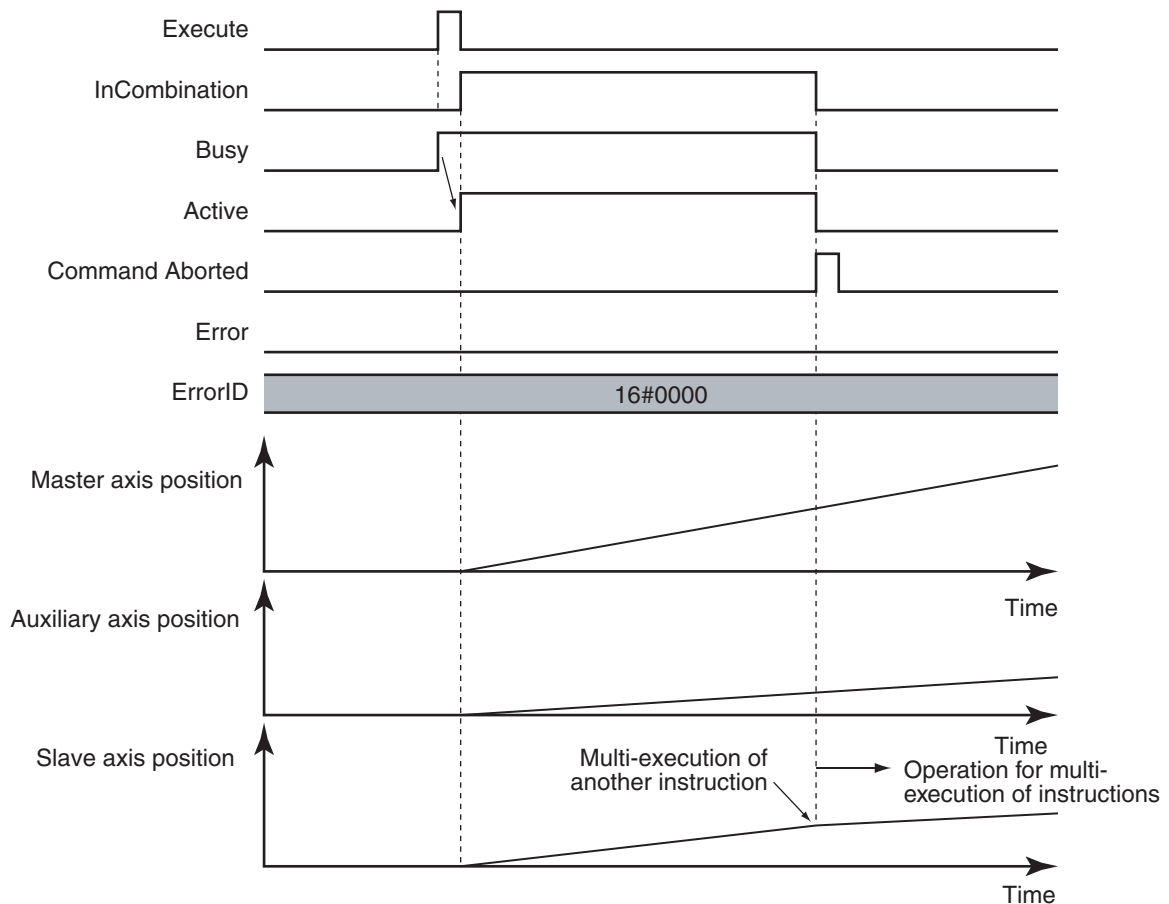

## Re-execution of Motion Control Instructions

This instruction cannot be re-executed.

A Motion Control Instruction Re-execution Disabled error (error code: 543B hex) occurs if re-execution is attempted.

## Multi-execution of Motion Control Instructions

For details on multi-execution of motion control instructions, refer to the *NJ/NX-series CPU Unit Motion Control User's Manual (Cat. No. W507)*.

### ● Execution of Other Instructions during Instruction Execution

To use multi-execution of instructions for this instruction, specify the slave axis.

When performing multi-execution of another instruction while this instruction is in execution, the following limits apply depending on *BufferMode* (Buffer Mode Selection).

- You can execute another instruction with the Buffer Mode set to **Aborting** during execution of this instruction.

You cannot specify **Buffered** or **Blending**.

## Errors

If an error occurs during instruction execution, *Error* will change to TRUE.

You can find out the cause of the error by referring to the value output by *ErrorID* (Error Code).

### ● Timing Chart When Error Occurs

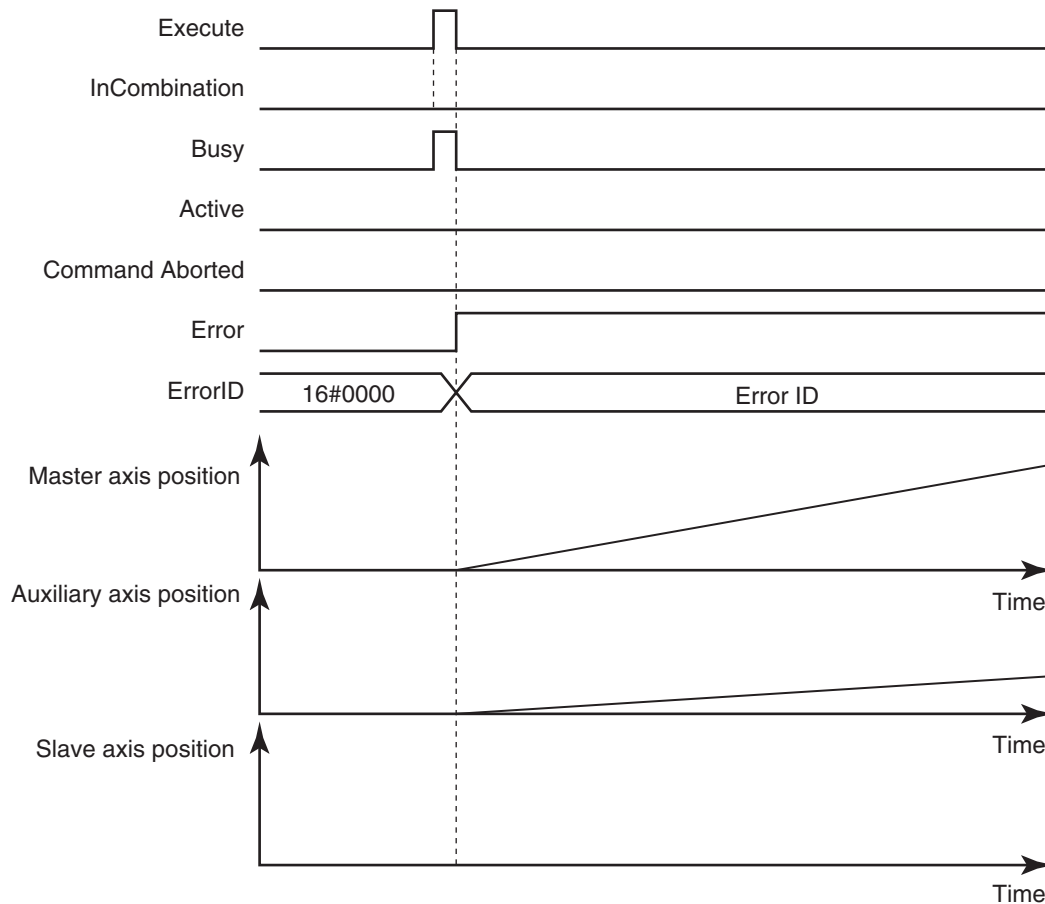

### Additional Information

- This instruction is not affected by errors in the *Master* (Master Axis) or the *Auxiliary* (Auxiliary Axis).
- After the error is cleared and the *Master* (Master Axis) or the *Auxiliary* (Auxiliary Axis) is in motion, the *Slave* (Slave Axis) will resume the combined positioning operation. The *Master* (Master Axis) and the *Auxiliary* (Auxiliary Axis) are not affected if an error occurs for the slave axis during startup or execution of this instruction, but this instruction is aborted.

If a minor fault level error occurs during instruction execution, *CommandAborted* will change to TRUE and the axis will stop.

The axis decelerates to a stop at **Maximum Deceleration** that is set in the axis parameters.

You can find out the cause of the error by referring to the value output to the *MFalutLvl.Code* Axis Variable for the *Slave* (Slave Axis).



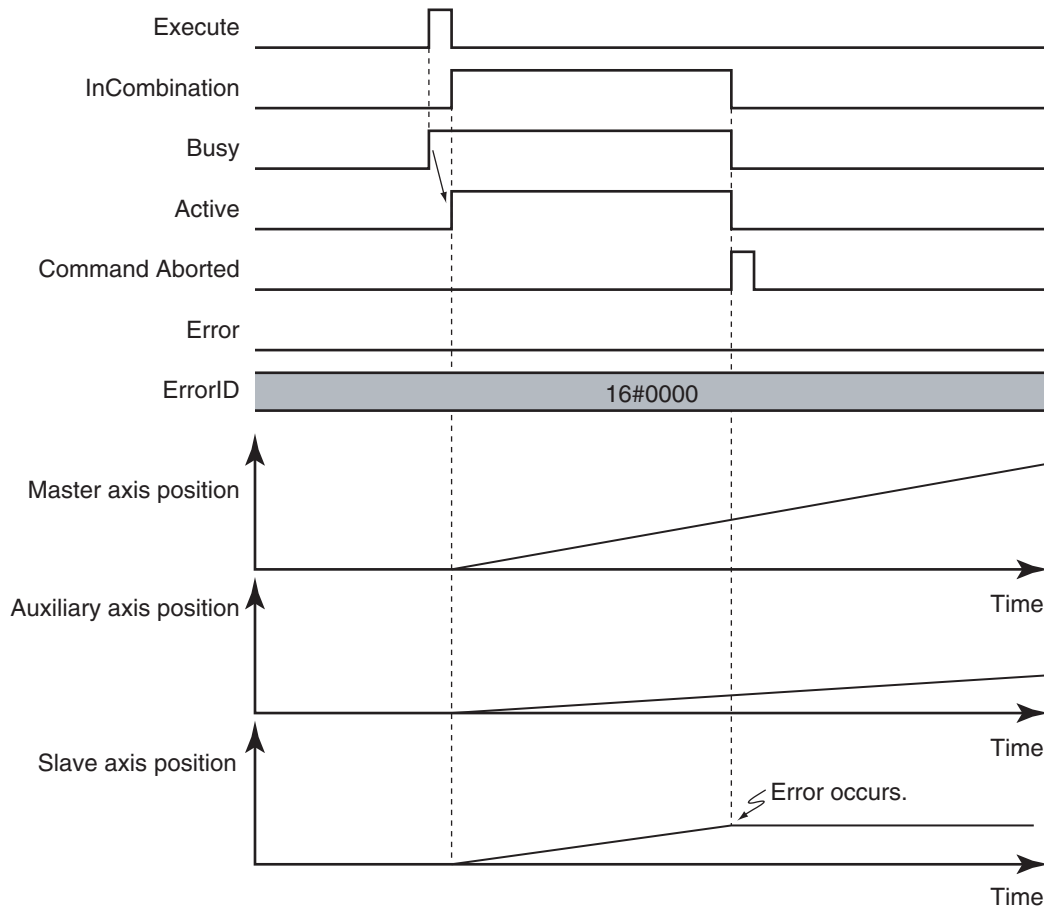

If you clear the error for this instruction, the instruction will not start until *Execute* changes to TRUE again.

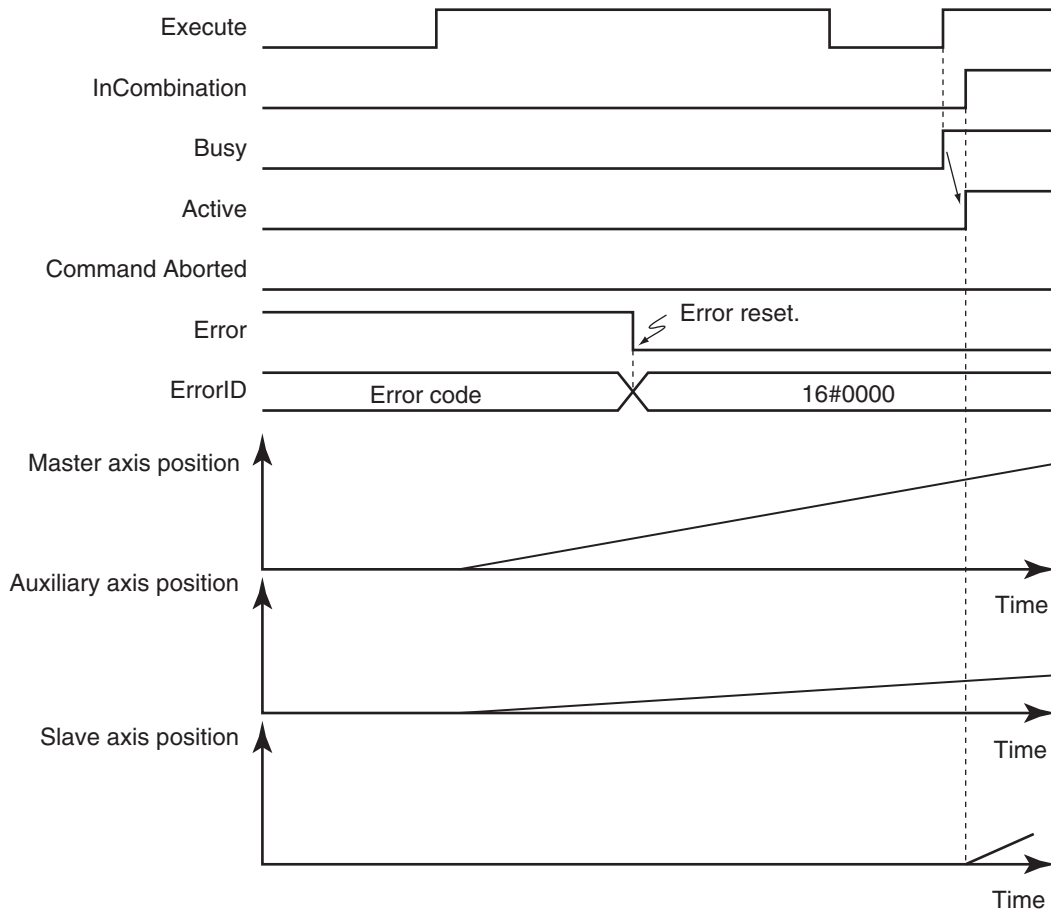

● **Error Codes**

Refer to the *NJ/NX-series Troubleshooting Manual (Cat. No. W503)* for instruction errors.

# MC\_Phasing

The MC\_Phasing instruction shifts the phase of the master axis currently in synchronized control.

Instruction	Name	FB/ FUN	Graphic expression	ST expression
MC_Phasing	Shift Master Axis Phase	FB		<pre>MC_Phasing_instance (   Master :=parameter,   Slave :=parameter,   Execute :=parameter,   PhaseShift :=parameter,   Velocity :=parameter,   Acceleration :=parameter,   Deceleration :=parameter,   Jerk :=parameter,   BufferMode :=parameter,   Done =&gt;parameter,   Busy =&gt;parameter,   Active =&gt;parameter,   CommandAborted =&gt;parameter,   Error =&gt;parameter,   ErrorID =&gt;parameter );</pre>

## Variables

### Input Variables

Name	Meaning	Data type	Valid range	De- fault	Description
Execute	Execute	BOOL	TRUE or FALSE	FALS E	The instruction is executed when this variable changes to TRUE.
PhaseShift	Phase shift amount	LREAL	Negative number, positive number, or 0	0	Specify the master axis phase shift amount. The unit is command units. *1
Velocity	Target Velocity	LREAL	Positive number	0	Specify the target velocity for the shift amount. *2 The unit is command units/s. *1
Acceleration	Acceleration Rate	LREAL	Non-negative number	0	Specify the acceleration rate. The unit is command units/s <sup>2</sup> . *1
Deceleration	Deceleration Rate	LREAL	Non-negative number	0	Specify the deceleration rate. The unit is command units/s <sup>2</sup> . *1
Jerk	Jerk	LREAL	Non-negative number	0	Specify the jerk. The unit is command units/s <sup>3</sup> . *1

Name	Meaning	Data type	Valid range	De- fault	Description
BufferMode	Buffer Mode Selection	_eMC_BUF-FER_MODE	0: _mcAborting	0*3	Specify the behavior when executing more than one motion instruction. 0: Aborting

- \*1. Refer to *Unit Conversion Settings* in the *NJ/NX-series CPU Unit Motion Control User's Manual (Cat. No. W507)*.
- \*2. Always set the target velocity. A Target Velocity Setting Out of Range error (error code: 5422 hex) occurs when the instruction is executed if the target velocity is not set.
- \*3. The default value for an enumeration variable is actually not the number, but the enumerator.

## Output Variables

Name	Meaning	Data type	Valid range	Description
Done	Done	BOOL	TRUE or FALSE	TRUE when the instruction is completed.
Busy	Executing	BOOL	TRUE or FALSE	TRUE when the instruction is acknowledged.
Active	Controlling	BOOL	TRUE or FALSE	TRUE when the axis is being controlled.
CommandAborted	Command Aborted	BOOL	TRUE or FALSE	TRUE when the instruction is aborted.
Error	Error	BOOL	TRUE or FALSE	TRUE while there is an error.
ErrorID	Error Code	WORD	*1	Contains the error code when an error occurs. A value of 16#0000 indicates normal execution.

- \*1. The upper four digits of the event code give the error code for ErrorID. Refer to the *NJ/NX-series Troubleshooting Manual (Cat. No. W503)* for the event codes.

### ● Output Variable Update Timing

Name	Timing for changing to TRUE	Timing for changing to FALSE
Done	When phase shift is completed.	<ul style="list-style-type: none"> <li>When <i>Execute</i> is TRUE and changes to FALSE.</li> <li>After one period when <i>Execute</i> is FALSE.</li> </ul>
Busy	When <i>Execute</i> changes to TRUE.	<ul style="list-style-type: none"> <li>When <i>Done</i> changes to TRUE.</li> <li>When <i>Error</i> changes to TRUE.</li> <li>When <i>CommandAborted</i> changes to TRUE.</li> </ul>
Active	When phase shift is started.	<ul style="list-style-type: none"> <li>When <i>Done</i> changes to TRUE.</li> <li>When <i>Error</i> changes to TRUE.</li> <li>When <i>CommandAborted</i> changes to TRUE.</li> </ul>

Name	Timing for changing to TRUE	Timing for changing to FALSE
CommandAborted	<ul style="list-style-type: none"> <li>When this instruction is aborted because another motion control instruction was executed with the Buffer Mode set to <b>Aborting</b>.</li> <li>When this instruction is canceled due to an error.</li> <li>When this instruction is executed while there is an error.</li> <li>When you start this instruction during MC_Stop instruction execution.</li> <li>When execution of the synchronized control instruction is completed.</li> </ul>	<ul style="list-style-type: none"> <li>When <i>Execute</i> is TRUE and changes to FALSE.</li> <li>After one period when <i>Execute</i> is FALSE.</li> </ul>
Error	When there is an error in the execution conditions or input parameters for the instruction.	When the error is cleared.

## In-Out Variables

Name	Meaning	Data type	Valid range	Description
Master	Master Axis	_sAXIS_REF	---	Specify the master axis. *1
Slave	Slave Axis	_sAXIS_REF	---	Specify the slave axis. *1

\*1. Specify a user-defined Axis Variable that was created in the Axis Basic Settings of the Sysmac Studio (default: MC\_Axis\*) or a system-defined axis variable name (\_MC\_AX[\*], \_MC1\_AX[\*], or \_MC2\_AX[\*]).

If you use Sysmac Studio version 1.29 or higher, you can specify the system-defined axis variable name for AT specification of a user-defined variable. This will allow you to specify the user-defined variable.

If you use Sysmac Studio version 1.28 or lower, do not specify any user-defined variable created in the variable table.



### Precautions for Correct Use

If you specify the same axis for the master axis and slave axis, a Master and Slave Defined as Same Axis minor fault (error code 5436 hex) will occur.

## Function

- Except during execution of the MC\_CombineAxes instruction, if the MC\_Phasing instruction is executed when single-axis synchronized control is in progress, the phase of the master axis is shifted according to the settings of *PhaseShift* (Phase Shift Amount), *Velocity* (Target Velocity), *Acceleration* (Acceleration Rate), and *Deceleration* (Deceleration Rate).
- The command current position and actual current position of the master axis do not change, and the relative shift between the command current position and actual current position of the master axis is taken as the phase of the master axis.  
The slave axis is synchronized to the shifted master axis phase.
- Done* changes to TRUE when the *PhaseShift* (Phase Shift Amount) is reached.
- Shifting is ended when execution of the synchronized control instruction is completed. If a synchronized control instruction is executed again, the previous amount of shift is not affected.
- You can shift the phase of the master axis for the following synchronized control instructions: MC\_CamIn (Start Cam Operation), MC\_GearIn (Start Gear Operation), MC\_GearInPos (Positioning Gear Operation), and MC\_MoveLink (Synchronous Positioning).

- In the user program, place the MC\_Phasing instruction after synchronized control instructions as shown below.

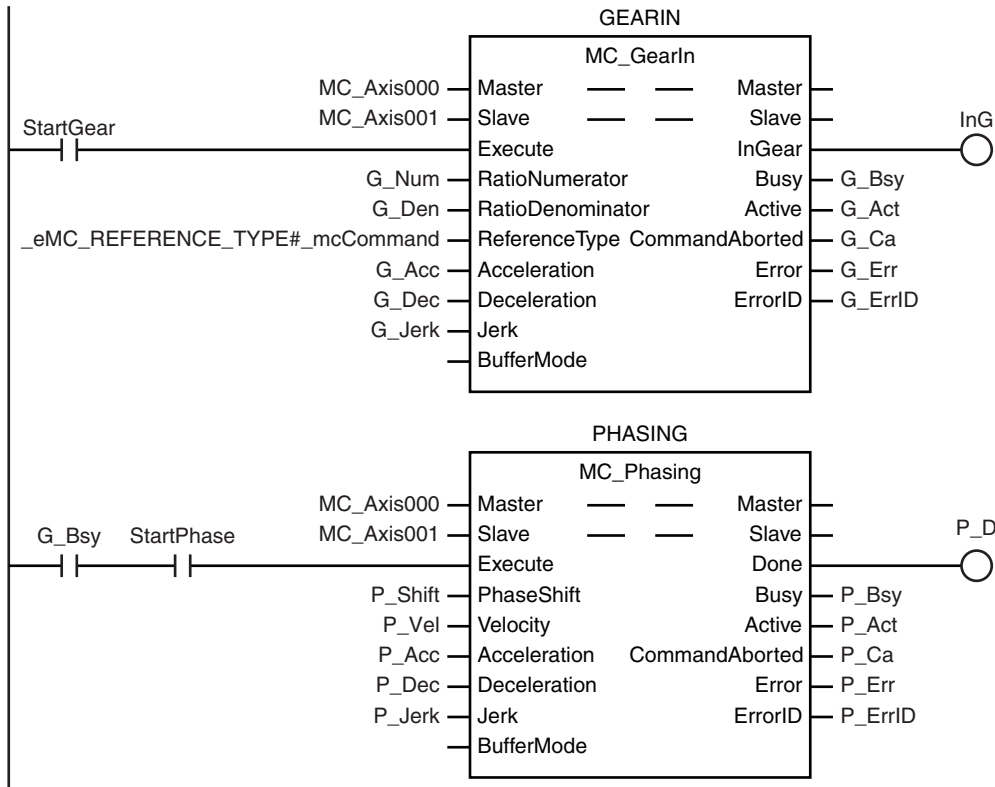

### Precautions for Correct Use

Refer to 1-1-3 *Precautions for Master and Auxiliary Axes in Synchronized Control* on page 1-6 for precautions on the master axis.

## Instruction Details

This section describes the instruction in detail.

### ● Specifying *Master* (Master Axis) and *Slave* (Slave Axis)

Specify axes variable names to specify the axes for *Master* (Master Axis) and *Slave* (Slave Axis). An axis specification error will occur if you specify a *Master* (Master Axis) or *Slave* (Slave Axis) for which execution of a synchronized control instruction is not in progress.

### ● PhaseShift (Phase Shift Amount)

Set the phase shift amount of the *Master* (Master Axis) as viewed from the *Slave* (Slave Axis) as the *PhaseShift* (Phase Shift Amount).

Specify the phase shift amount as a relative value.

### ● Velocity (Target Velocity), Acceleration (Acceleration Rate), Deceleration (Deceleration Rate), and Jerk

Set *Velocity*, *Acceleration*, *Deceleration*, and *Jerk* to specify the target velocity (shift velocity), acceleration rate, deceleration rate, and jerk for the phase shift amount.

The target velocity (shift velocity) as viewed from the *Slave* (Slave Axis) is the velocity relative to the *Master* (Master Axis) velocity.

The target velocity (shift velocity) of the *Master* (Master Axis) as viewed from the *Slave* (Slave Axis) is shown below as specified by the phase shift amount, acceleration rate, deceleration rate, and jerk.

#### Example: Master Axis Phase Shift for an Electronic Cam

The shift velocity as viewed from the *Slave* (Slave Axis) is the velocity relative to the *Master* (Master Axis) velocity.

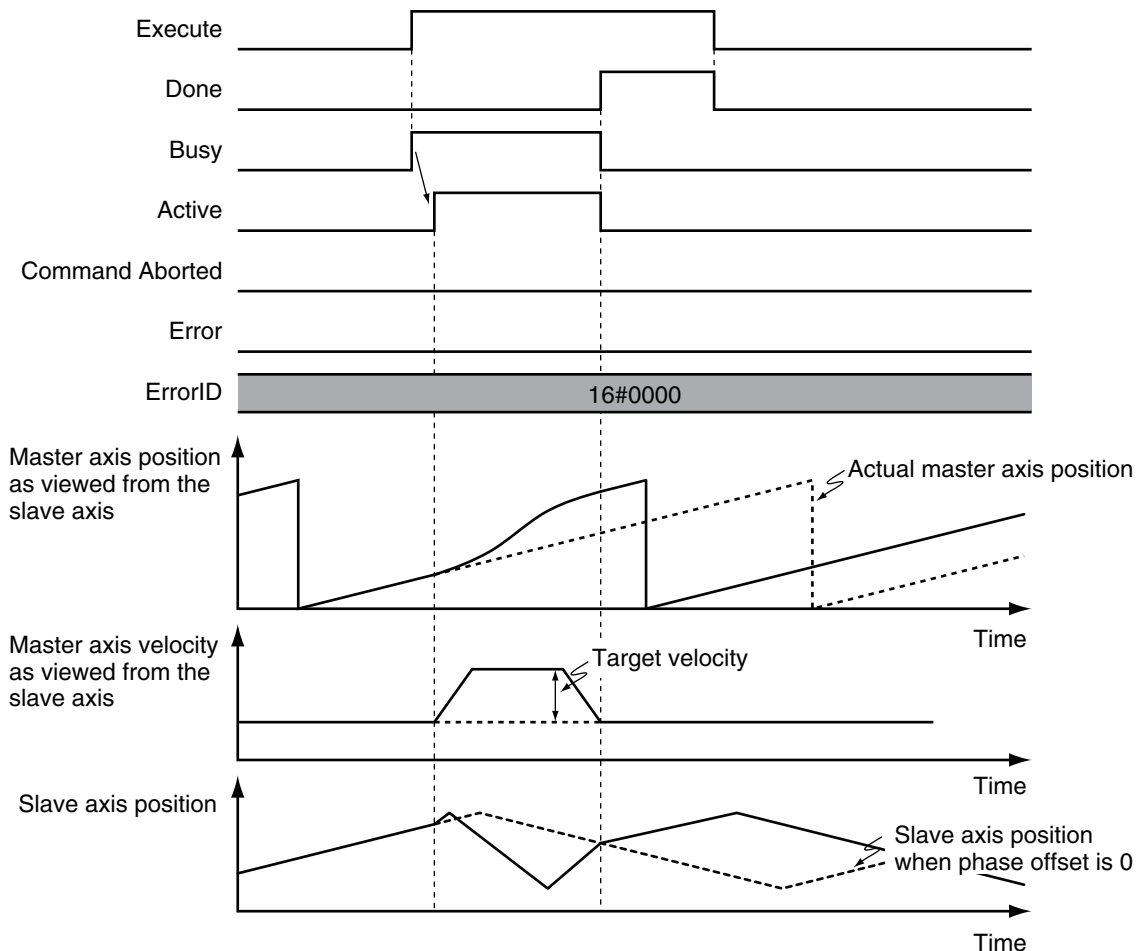

- If you set the phase shift amount to 0, the phase shift amount of the *Master* (Master Axis) will be 0 and the instruction ends normally.
- If you set the target velocity (shift velocity) to 0, a *Slave* (Slave Axis) error will occur because the value is out of range.
- The sum of the specified target velocity (shift velocity) and the *Master* (Master Axis) velocity can exceed the maximum velocity of the *Master* (Master Axis).



### Additional Information

Error detection for the results of the MC\_Phasing instruction is performed for the operation of the synchronized *Slave* (Slave Axis).

Therefore, error detection is not performed for the settings of the *Velocity* (Target Velocity), *Acceleration* (Acceleration Rate), and *Deceleration* (Deceleration Rate) variables when the MC\_Phasing instruction is executed.

### ● BufferMode (Buffer Mode Selection)

This variable specifies how to join the axis motions for this instruction and the previous instruction. There is only the following setting.

Buffer Mode Selection	Description
Aborting	If this instruction is re-executed, the shift for the instruction is started immediately.

Reversing operation for multi-execution of instructions is performed according to the **Operation Selection at Reversing** setting for the master axis.

For details on *BufferMode* (Buffer Mode Selection), refer to the *NJ/NX-series CPU Unit Motion Control User's Manual (Cat. No. W507)*.

### ● In-position Check

When the phase shift operation is completed, phase shift output is ended and an in-position check is not performed.

## Re-execution of Motion Control Instructions

If you re-execute the instruction during instruction execution, you can change the *PhaseShift* (Phase Shift Amount), *Velocity* (Target Velocity), *Acceleration* (Acceleration Rate), and *Deceleration* (Deceleration Rate).

They are changed in the same way as for relative positioning.

## Multi-execution of Motion Control Instructions

For details on multi-execution of motion control instructions, refer to the *NJ/NX-series CPU Unit Motion Control User's Manual (Cat. No. W507)*.

### ● Execution of Other Instructions during Instruction Execution

You can execute another instruction with the Buffer Mode set to **Aborting** for the *Slave* (Slave Axis) during execution of this instruction.

You cannot specify **Buffered** or **Blending**.

### ● Multi-execution of MC\_Phasing Instructions

You can execute the MC\_Phasing instruction even if the MC\_Phasing instruction is already in execution for the specified slave axis.



## Error

If an error occurs during instruction execution, *Error* will change to TRUE.

You can find out the cause of the error by referring to the value output by *ErrorID* (Error Code).

*CommandAborted* of the MC\_Phasing (Shift Master Axis Phase) instruction changes to TRUE when the *Slave* (Slave Axis) is released from synchronization due to an error.

The error state of the master axis does not affect the operation of this instruction.

### ● Timing Chart When Error Occurs

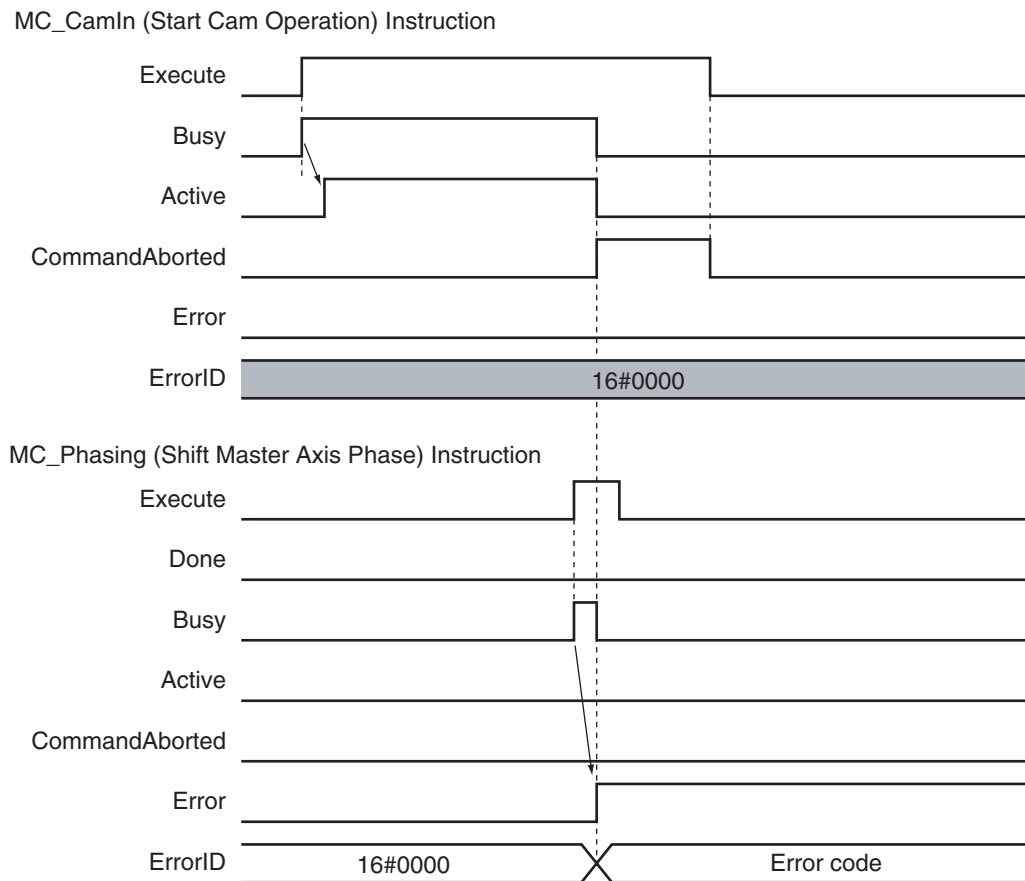

### ● Error Codes

Refer to the *NJ/NX-series Troubleshooting Manual (Cat. No. W503)* for instruction errors.

# MC\_TorqueControl

The MC\_TorqueControl instruction uses the Torque Control Mode of the Servo Drive to control the torque.

Instruction	Name	FB/ FUN	Graphic expression	ST expression
MC_TorqueControl	Torque Control	FB		<pre>MC_TorqueControl_instance (   Axis :=parameter,   Execute :=parameter,   Torque :=parameter,   TorqueRamp :=parameter,   Velocity :=parameter,   Direction :=parameter,   BufferMode :=parameter,   InTorque =&gt;parameter,   Busy =&gt;parameter,   Active =&gt;parameter,   CommandAborted =&gt;parameter,   Error =&gt;parameter,   ErrorID =&gt;parameter );</pre>



## Precautions for Correct Use

You cannot use this instruction for an NX-series Pulse Output Unit.

## Variables

### Input Variables

Name	Meaning	Data type	Valid range	De- fault	Description
Execute	Execute	BOOL	TRUE or FALSE	FALS E	The instruction is executed when the value of this variable changes to TRUE.
Torque	Target Tor- que	LREAL	0 to 1000.0	300.0	Specify the target torque to output to the Servo Drive in increments of 0.1%. Specify a percentage of the rated torque, i.e., the rated torque is 100.0%. *1 The unit is %.
TorqueRamp	Torque Ramp	LREAL	Non-negative number	0	Specify the change rate of torque from the current value to the target torque. The unit is %/s.
Velocity	Velocity Limit	LREAL	Non-negative number	0	Specify the target velocity. The unit is command units/s. *2

Name	Meaning	Data type	Valid range	Default	Description
Direction	Direction	_eMC_DIRECTION	0: _mcPositiveDirection 2: _mcNegativeDirection	0*3	Specify the direction of the target torque. 0: Positive direction 2: Negative direction
BufferMode	Buffer Mode Selection	_eMC_BUFFER_MODE	0: _mcAborting 1: _mcBuffered	0*3	Specify the behavior when executing more than one motion instruction. 0: Aborting 1: Buffered

- \*1. If a value that is higher than 1,000.0% is specified, it will be treated as 1,000.0%. If a negative value is specified, it will be treated as 0.0%.
- \*2. Refer to *Unit Conversion Settings* in the *NJ/NX-series CPU Unit Motion Control User's Manual (Cat. No. W507)* for information on command units.
- \*3. The default value for an enumeration variable is actually not the number, but the enumerator.

## Output Variables

Name	Meaning	Data type	Valid range	Description
InTorque	Target Torque Reached	BOOL	TRUE or FALSE	TRUE when the target torque is reached.
Busy	Executing	BOOL	TRUE or FALSE	TRUE when the instruction is acknowledged.
Active	Controlling	BOOL	TRUE or FALSE	TRUE when the axis is being controlled.
CommandAborted	Command Aborted	BOOL	TRUE or FALSE	TRUE when the instruction is aborted.
Error	Error	BOOL	TRUE or FALSE	TRUE while there is an error.
ErrorID	Error Code	WORD	*1	Contains the error code when an error occurs. A value of 16#0000 indicates normal execution.

- \*1. The upper four digits of the event code give the error code for ErrorID. Refer to the *NJ/NX-series Troubleshooting Manual (Cat. No. W503)* for the event codes.

### ● Output Variable Update Timing

Name	Timing for changing to TRUE	Timing for changing to FALSE
InTorque	When target torque is output.	<ul style="list-style-type: none"> <li>When <i>Error</i> changes to TRUE.</li> <li>When <i>CommandAborted</i> changes to TRUE.</li> <li>When the instruction is re-executed and the target torque is changed.</li> </ul>
Busy	When <i>Execute</i> changes to TRUE.	<ul style="list-style-type: none"> <li>When <i>Error</i> changes to TRUE.</li> <li>When <i>CommandAborted</i> changes to TRUE.</li> </ul>
Active	When output of the torque command value starts.	<ul style="list-style-type: none"> <li>When <i>Error</i> changes to TRUE.</li> <li>When <i>CommandAborted</i> changes to TRUE.</li> </ul>

Name	Timing for changing to TRUE	Timing for changing to FALSE
CommandAborted	<ul style="list-style-type: none"> <li>When this instruction is aborted because another motion control instruction was executed with the Buffer Mode set to <b>Aborting</b>.</li> <li>When this instruction is canceled due to an error.</li> <li>When this instruction is executed while there is an error.</li> <li>When you start this instruction during MC_Stop instruction execution.</li> </ul>	<ul style="list-style-type: none"> <li>When <i>Execute</i> is TRUE and changes to FALSE.</li> <li>After one period when <i>Execute</i> is FALSE.</li> </ul>
Error	When there is an error in the execution conditions or input parameters for the instruction.	When the error is cleared.

## In-Out Variables

Name	Meaning	Data type	Valid range	Description
Axis	Axis	_sAXIS_REF	---	Specifies the axis. *1

\*1. Specify a user-defined Axis Variable that was created in the Axis Basic Settings of the Sysmac Studio (default: MC\_Axis\*) or a system-defined axis variable name (\_MC\_AX[\*], \_MC1\_AX[\*], or \_MC2\_AX[\*]).

If you use Sysmac Studio version 1.29 or higher, you can specify the system-defined axis variable name for AT specification of a user-defined variable. This will allow you to specify the user-defined variable.

If you use Sysmac Studio version 1.28 or lower, do not specify any user-defined variable created in the variable table.

## Function

- The MC\_TorqueControl instruction controls the output torque of the Servomotor by directly specifying the torque command value.
- Set the target torque in increments of 0.1%. If the second decimal place is specified, it will be rounded off.
- Use the MC\_Stop instruction to stop the execution of this instruction.
- The Torque Control Mode of the Servo Drive is used to perform torque control.
- The previous Control Mode is maintained until it is changed.

### Example:

Changing from position control to torque control: Position control is performed until the Servo Drive changes to torque control.

Changing from torque control to position control: Torque control is performed until the Servo Drive changes to position control.

## ● Mapping Data Objects

To use the MC\_TorqueControl (Torque Control) instruction, map the following object data in the **Detailed Settings** Area of the Axis Basic Settings Display of the Sysmac Studio.

- Target torque (6071 hex)
- Modes of operation (6060 hex)
- Torque actual value (6077 hex)
- Modes of operation display (6061 hex)

If even one of the required objects is not set, a Process Data Object Setting Missing error (error code 3461 hex) occurs.

For details on mapping data objects, refer to *2-3 PDO Mapping* on page 2-39 and to the *NJ/NX-series CPU Unit Motion Control User's Manual (Cat. No. W507)*.

## Instruction Details

This section describes the instruction in detail.

### ● Specifying Axis

*Axis* specifies the axis for torque control.

### ● TorqueRamp

Specify the slope from the currently specified command torque until the target torque is output.

#### Example 1: Direction Set to 0: Positive direction

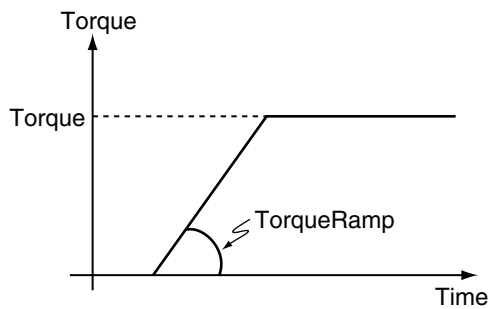

#### Example 2: Direction Set to 2: Negative direction

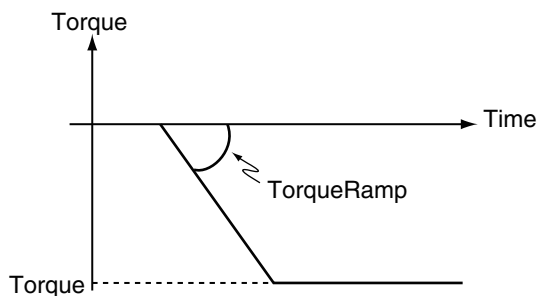

#### Precautions for Correct Use

Set the target torque so that the maximum torque of the motor is not exceeded.  
The operation that is performed when the maximum torque of the motor is exceeded depends on the Servo Drive.

### ● Velocity (Velocity Limit)

This variable limits the maximum velocity of the axis during torque control.

When the axis velocity reaches this velocity limit, the Servo Drive reduces the torque to reduce the axis velocity.

The velocity limit function uses the Servo Drive function.

For details, refer to information on the torque control function in the user manual for the Servo Drive.



### Precautions for Correct Use

- The axis velocity increases faster during torque control. Make sure that you set *Velocity* (velocity limit) for safety.
- When you use an OMRON G5-series Servo Drive, set the Velocity Limit Selection (3317 hex) of the Servo Drive to 1 (velocity limit value via EtherCAT communications). Otherwise, the velocity limit is not affected. Also, the axis does not stop even if the limit input signal turns ON.
- Process data 607F hex is used for the velocity limit value.  
When you use an OMRON 1S-series Servo Drive or G5-series Servo Drive, set the **Detailed Settings** in the Axis Parameter Settings of the Sysmac Studio to use the Velocity Limit Value (607F hex).  
To use a velocity limit with a servo drive from another manufacturer, refer to the manual for the servo drive.

### ● Direction

This variable specifies the direction to output the target torque.

If you want to output torque in the positive direction of the axis, set the positive direction. If you want to output torque to the negative direction of the axis, set the negative direction.

### ● BufferMode (Buffer Mode Selection)

This variable specifies how to join the axis motions for this instruction and the previous instruction.

There is currently only the following two settings.

Buffer Mode Selection	Description
Aborting	Aborts the instruction being executed and switches to this instruction.
Buffered	Automatically executes the buffered instruction after the current instruction is completed.

For details on *BufferMode* (Buffer Mode Selection), refer to the *NJ/NX-series CPU Unit Motion Control User's Manual (Cat. No. W507)*.

### ● Stopping Axes during Torque Control

If MC\_Stop is executed during MC\_TorqueControl execution for an OMRON 1S-series Servo Drive or G5-series Servo Drive, the deceleration rate that is specified for the MC\_Stop instruction is not used and an immediate stop is performed.

An immediate stop is performed even for errors that normally result in deceleration stops.

### ● Command Position and Actual Position during Torque Control

The following current positions are given in the system-defined variables for motion control during torque control for this instruction.

Actual current position : Contains the value returned by the Servo Drive multiplied by the gear ratio.

Command current position : Contains the actual current position from the previous period.

### ● Applicable Axes and Execution Condition

- For a servo axis, this instruction is ready for execution as soon as *Enable* for the MC\_Power (Power Servo) instruction changes to TRUE (Servo ON).
- A virtual servo axis will acknowledge this instruction at any time. However, processing to switch the Control Mode of the Servo Drive is not performed.
- An error occurs if the instruction is executed for an encoder or virtual encoder axis.

### ● Operation When Servo Turns OFF

Processing to change to CSP Mode is performed by the MC Function Module when the *Status* output variable from the MC\_Power (Power Servo) instruction changes to FALSE.

However, for an OMRON G5-series Servo Drive, commands to change the Control Mode are not acknowledged from the MC Function Module when the Servo is OFF.

### ● Axis Variable Status

*Status.Continuous* (Continuous Motion) in the Axis Variable status changes to TRUE.

Also, CST (Cyclic Synchronous Torque (CST) Control Mode) in *DrvStatus* (Servo Drive Status) in the Axis Variable changes to TRUE.

### ● Home Status

Home remains defined.

### ● Software Limits

Software Limits are enabled for this instruction.

They are enabled even for the following axis parameter settings.

- Enabled for command position. Deceleration stop.
- Enabled for command position. Stop using remaining pulses.

### ● When Count Mode Is Set to Linear Mode

The operation for underflows and overflows is the same as for operations that do not have target positions.

### ● Operation Selection at Reversing

If multi-execution is performed and the torque command value is reversed, operation is performed with *TorqueRamp* from this instruction and not with the setting of the **Operation Selection at Reversing** axis parameter.

The operation for reversing for multi-execution of instructions is as follows:

- If the command position reverses for multi-execution of an instruction that uses CSP during execution of this instructions, the operation at reversing is performed according to the **Operation Selection at Reversing** axis parameter.
- If the torque command value reverses when multi-execution of this instruction is performed during execution of an instruction that uses CSP or CSV, the torque command reverses according to *TorqueRamp*.
- If the torque command value reverses when multi-execution of this instruction is performed during execution of this instruction, the torque command reverses according to *TorqueRamp*.

## Timing Charts

### Starting and Stopping the Instruction

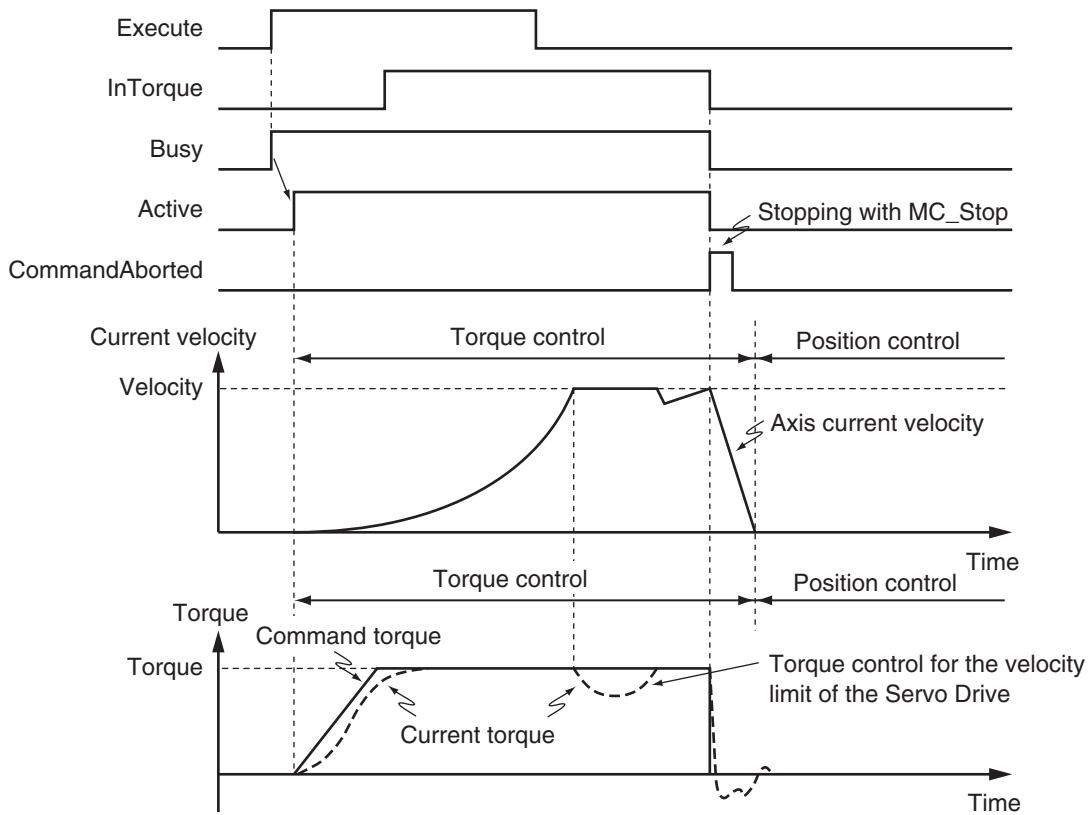

### Instruction Execution to Abort Immediately Preceding Operation

The following timing chart shows an application in which the axis stops and holding is performed while this instruction is in execution.



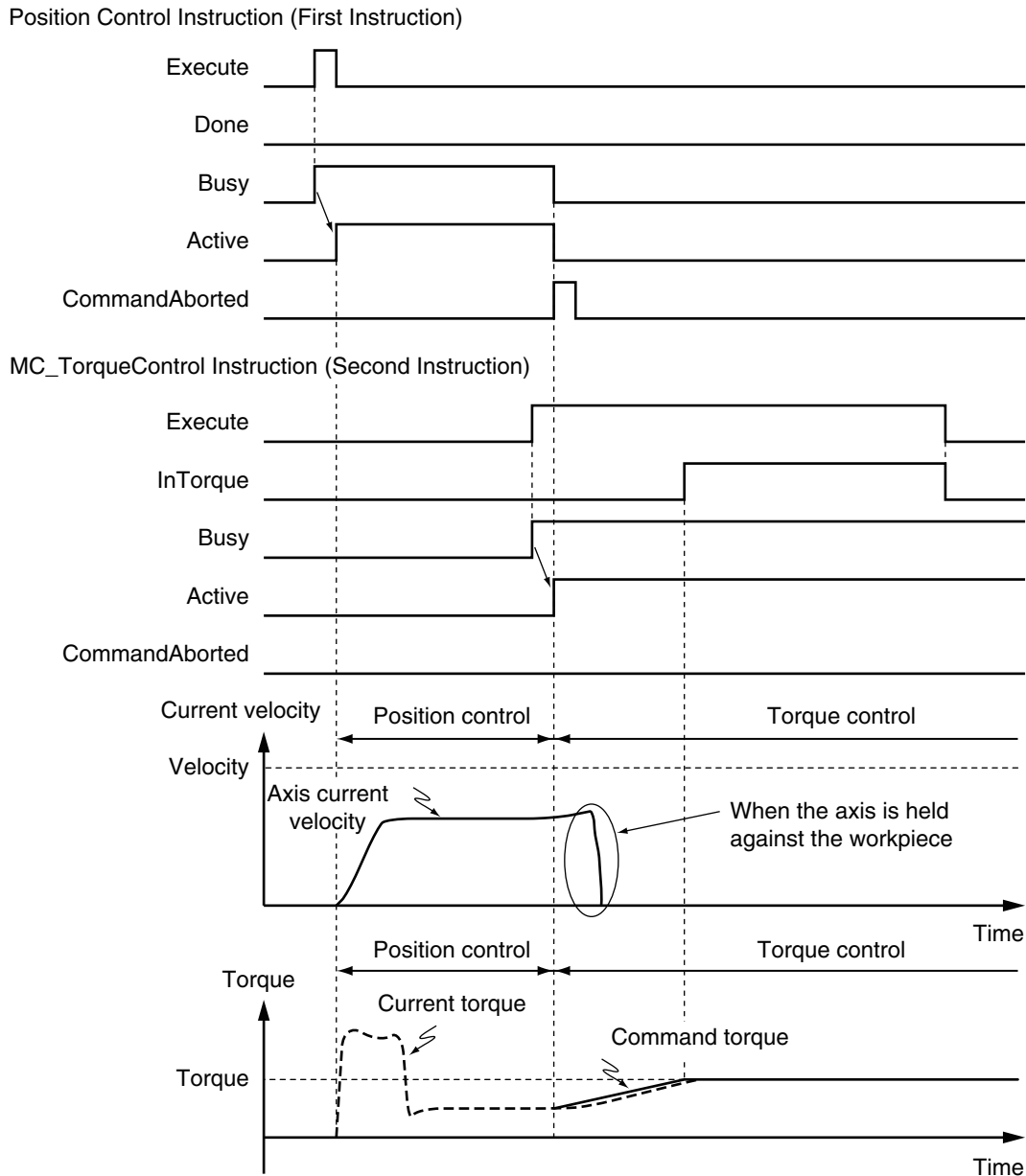

**Instruction Execution for Buffered during Immediately Preceding Operation**

The following timing chart shows an application in which the axis stops and holding is performed while this instruction is in execution.

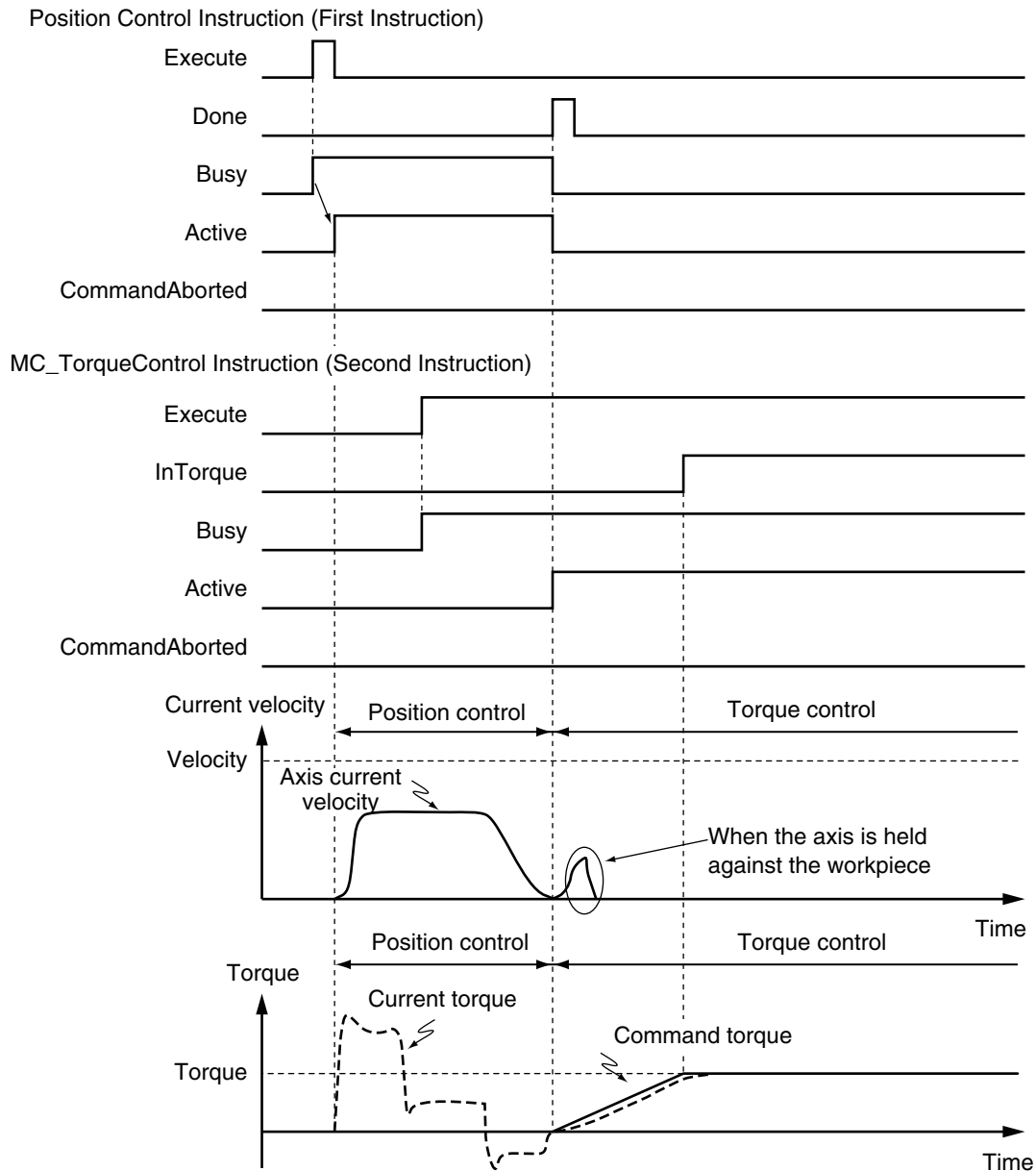

### ● Changing the Control Mode

- If you execute the MC\_TorqueControl instruction while a position control instruction, such as the MC\_MoveAbsolute (Absolute Positioning) or MC\_MoveRelative (Relative Positioning) instruction, is in execution, the operation depends on the setting of the *BufferMode* (Buffer Mode Selection) of the MC\_TorqueControl instruction.

If *BufferMode* is set to **Aborting**, the Control Mode changes to Torque Control as soon as the instruction is executed. If the Buffer Mode is set to **Buffered**, the Control Mode changes to Torque Control after the previous operation is completed.

- If the MC\_TorqueControl instruction is aborted by other instructions such as MC\_MoveAbsolute (Absolute Positioning), or if an axis error occurs, the Control Mode changes to Position Control at that point.
- *Active* (Controlling) changes when the instruction is executed, but it takes several periods for the Control Mode in the Servo Drive to change. The time that is required for the Control Mode to change depends on the Servo Drive.

**Criteria for Changing the Control Mode**

When you stop an axis for an OMRON 1S-series Servo Drive or G5-series Servo Drive, the MC Function Module sets the Velocity Limit Value (607F hex) to 0. The Control Mode is changed to CSP Mode when the following criterion is met for three consecutive periodic tasks after that.

Actual current velocity  $\leq$  Maximum velocity  $\times$  0.1

With a servo drive from another manufacturer, the Control Mode of the Servo Drive changes from CST to CSP Mode and the Servo is turned ON at the actual current position when the mode changes.

**Precautions for Correct Use**

---

Here, the periodic task is the primary periodic task or the priority-5 periodic task.

---

**Failure to Change the Control Mode**

If the Servo Drive does not complete switching the Control Mode within 1 second after a Control Mode switch command is sent from the MC Function Module, an Error in Changing Servo Drive Control Mode (error code: 7439 hex) occurs and the Servo is turned OFF, i.e., a free-run stop occurs.

For details on the Error in Changing Servo Drive Control Mode (error code: 7439 hex), refer to the *NJ/NX-series CPU Unit Motion Control User's Manual (Cat. No. W507)*.

If the criteria for changing is not met within 10 seconds after the Velocity Limit Value is set to 0, the Servo is turned OFF in the same way as given above.

**Operation Examples for Changing the Control Mode**

The relationship between the command torque and command velocity until the Control Mode changes is described in the following examples where the Control Mode is changed during axis operation.

**Precautions for Correct Use**

---

An error will occur in some Servo Drives if the Control Mode in the Servo Drive changes during axis motion.

---

**Changing from Position Control to Torque Control**

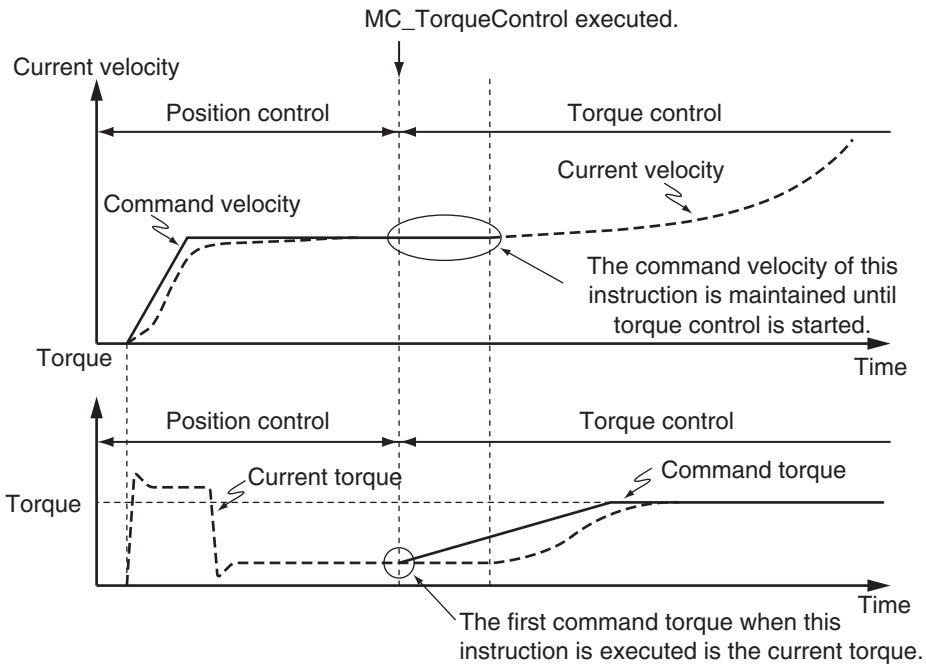

### Changing from Torque Control to Position Control

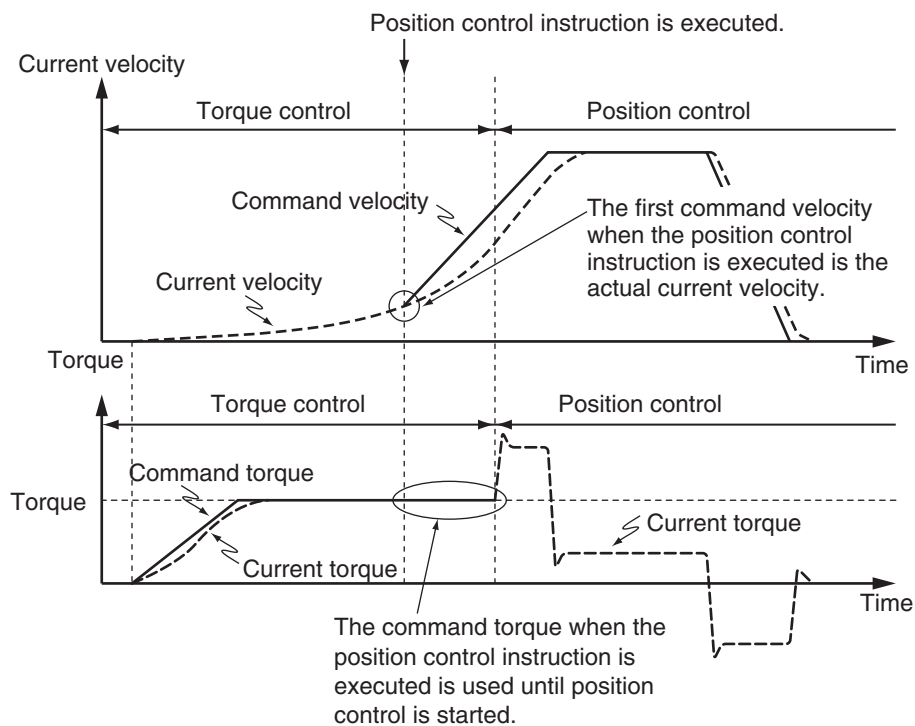

## Re-execution of Motion Control Instructions

You can change the operation of the instruction if you change the input parameter during torque control and then change *Execute* to TRUE again. You can change the *Torque* (Target Torque), *TorqueRamp*, and *Velocity* (Velocity Limit) input variables by re-executing the motion control instruction.

When the motion control instruction is re-executed to change *Torque* (Target Torque), *InTorque* (Target Torque Reached) operates for the new target torque that was set at re-execution.

For details on re-execution of motion control instructions, refer to the *NJ/NX-series CPU Unit Motion Control User's Manual (Cat. No. W507)*.

## Multi-execution of Motion Control Instructions

For details on multi-execution of motion control instructions, refer to the *NJ/NX-series CPU Unit Motion Control User's Manual (Cat. No. W507)*.

### ● Execution during Execution of Other Instructions

You can switch to this instruction or buffer this instruction if you execute it during execution of another instruction.

You can buffer one instruction per axis.

Specify the operation of this instruction by using *BufferMode* (Buffer Mode Selection) for multi-execution of instructions.

Buffer Mode Selection	Description
Aborting	Aborts the instruction being executed and switches to this instruction.
Buffered	Buffers this instruction and executes it automatically after the current instruction is completed.

For details on *BufferMode* (Buffer Mode Selection), refer to the *NJ/NX-series CPU Unit Motion Control User's Manual (Cat. No. W507)*.

### ● Execution of Other Instructions during Instruction Execution

If another instruction is executed during execution of this instruction, the *BufferMode* (Buffer Mode Selection) input variable to the other instruction must be set to **Aborting** or **Buffered**.

## Errors

If an error occurs during instruction execution, *Error* will change to TRUE.

You can find out the cause of the error by referring to the value output by *ErrorID* (Error Code).

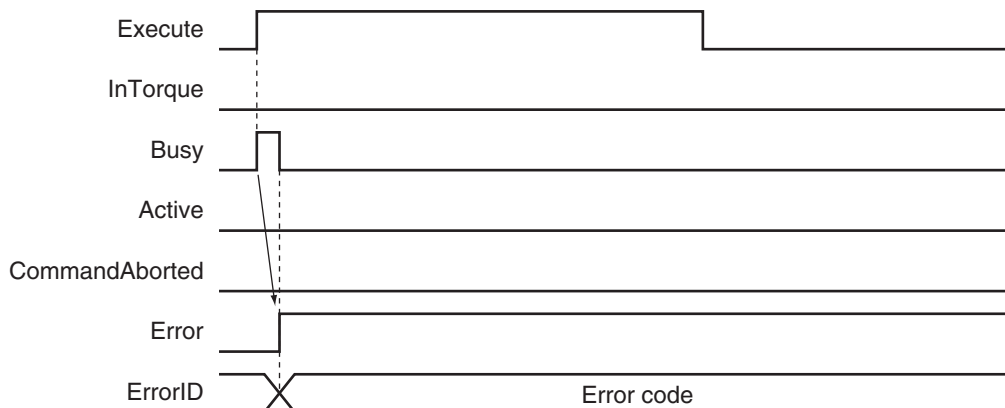

- **Error Codes**

Refer to the *NJ/NX-series Troubleshooting Manual (Cat. No. W503)* for instruction errors.

# MC\_SetTorqueLimit

The MC\_SetTorqueLimit instruction limits the torque output from the Servo Drive through the torque limit function of the Servo Drive.

Instruction	Name	FB/ FUN	Graphic expression	ST expression
MC_SetTorqueLimit	Set Torque Limit	FB		<pre>MC_SetTorqueLimit_instance (   Axis :=parameter,   Enable :=parameter,   PositiveEnable :=parameter,   PositiveValue :=parameter,   NegativeEnable :=parameter,   NegativeValue :=parameter,   Enabled =&gt;parameter,   Busy =&gt;parameter,   Error =&gt;parameter,   ErrorID =&gt;parameter );</pre>



## Precautions for Correct Use

You cannot use this instruction for an NX-series Pulse Output Unit.

## Variables

### Input Variables

Name	Meaning	Data type	Valid range	Default	Description
Enable	Enable	BOOL	TRUE or FALSE	FALSE	The instruction is executed while this variable is TRUE.
PositiveEnable	Positive Direction Enable	BOOL	TRUE or FALSE	FALSE	TRUE: Enables the positive torque limit. FALSE: Disables the positive torque limit.
PositiveValue	Positive Torque Limit	LREAL	0.1 to 1,000.0, or 0.0	300.0	Set the torque limit in the positive direction in increments of 0.1%. If a value that exceeds the <b>Maximum Positive Torque Limit</b> axis parameter is input, the positive torque will be the <b>Maximum Positive Torque Limit</b> . The value will be 0 if 0 or a negative value is specified.
NegativeEnable	Negative Direction Enable	BOOL	TRUE or FALSE	FALSE	TRUE: Enables the negative torque limit. FALSE: Disables the negative torque limit.

Name	Meaning	Data type	Valid range	Default	Description
NegativeValue	Negative Torque Limit	LREAL	0.1 to 1,000.0, or 0.0	300.0	Set the torque limit in the negative direction in increments of 0.1%. If a value that exceeds the <b>Maximum Negative Torque Limit</b> axis parameter is input, the negative torque will be the <b>Maximum Negative Torque Limit</b> . The value will be 0 if 0 or a negative value is specified.

## Output Variables

Name	Meaning	Data type	Valid range	Description
Enabled	Enable	BOOL	TRUE or FALSE	TRUE when control is in progress. *1
Busy	Executing	BOOL	TRUE or FALSE	TRUE when the instruction is acknowledged.
Error	Error	BOOL	TRUE or FALSE	TRUE while there is an error.
ErrorID	Error Code	WORD	*2	Contains the error code when an error occurs. A value of 16#0000 indicates normal execution.

\*1. *Enabled* indicates the status of the instruction. It does not indicate the status of torque control by the Servo Drive.

\*2. The upper four digits of the event code give the error code for ErrorID. Refer to the *NJ/NX-series Troubleshooting Manual (Cat. No. W503)* for the event codes.

### ● Output Variable Update Timing

Name	Timing for changing to TRUE	Timing for changing to FALSE
Enabled	<ul style="list-style-type: none"> <li>When <i>Enable</i> changes to TRUE.</li> <li>When MC_Power is being executed.</li> </ul>	<ul style="list-style-type: none"> <li>One period after <i>Enable</i> changes to FALSE.</li> <li>When <i>Error</i> changes to TRUE.</li> <li>When <i>Enable</i> for the MC_Power instruction changes to FALSE.</li> </ul>
Busy	When <i>Enable</i> changes to TRUE.	<ul style="list-style-type: none"> <li>When <i>Error</i> changes to TRUE.</li> <li>When <i>Enable</i> changes to FALSE.</li> </ul>
Error	When there is an error in the execution conditions or input parameters for the instruction.	When the error is cleared.

## In-Out Variables

Name	Meaning	Data type	Valid range	Description
Axis	Axis	_sAXIS_REF	---	Specifies the axis. *1

\*1. Specify a user-defined Axis Variable that was created in the Axis Basic Settings of the Sysmac Studio (default: MC\_Axis\*) or a system-defined axis variable name (\_MC\_AX[\*], \_MC1\_AX[\*], or \_MC2\_AX[\*]).

If you use Sysmac Studio version 1.29 or higher, you can specify the system-defined axis variable name for AT specification of a user-defined variable. This will allow you to specify the user-defined variable.

If you use Sysmac Studio version 1.28 or lower, do not specify any user-defined variable created in the variable table.



## Function

- The MC\_SetTorqueLimit instruction sets the torque limits that are used by the Servo Drive.
- When *Enable* is TRUE and *PositiveEnable* (Positive Direction Enable) changes to TRUE, control is performed with *PositiveValue* (Positive Torque Limit).  
When *Enable* is TRUE and *NegativeEnable* (Negative Direction Enable) changes to TRUE, control is performed with *NegativeValue* (Negative Torque Limit).
- When *PositiveEnable* (Positive Direction Enable) changes to FALSE, the value of the **Maximum Positive Torque Limit** is set in the Servo Drive.  
When *NegativeEnable* (Negative Direction Enable) changes to FALSE, the value of the **Maximum Negative Torque Limit** is set in the Servo Drive.
- When *Enable* to this instruction changes to FALSE, the values of the **Maximum Positive Torque Limit** and **Maximum Negative Torque Limit** are set in the Servo Drive. At the same time, *Busy* (Executing) and *Enabled* change to FALSE.
- The torque limits are set as a percentage of the motor torque in 0.1% increments. If the second decimal place is specified, it will be rounded off to one decimal place.



### Precautions for Correct Use

Set the **Maximum Positive Torque Limit** and **Maximum Negative Torque Limit** axis parameters to the upper limits of torque control for your Servo Drive.

## ● Mapping Data Objects

To use the MC\_SetTorqueLimit instruction, map the following object data in the **Detailed Settings** Area of the Axis Basic Settings Display of the Sysmac Studio.

- Positive torque limit value (60E0 hex)
- Negative torque limit value (60E1 hex)

If even one of the required objects is not set, a Process Data Object Setting Missing error (error code 3461 hex) occurs.



### Precautions for Correct Use

- If you use a servo drive from a different manufacturer, set the servo drive so that the positive torque limit value (PDO 60E0 hex) and the negative torque limit value (PDO 60E1 hex) are used as the torque limits.  
Refer to the manual for your servo drive for the setting procedure.
- This instruction cannot be used for servo drives from other manufacturers unless the positive torque limit value and the negative torque limit value can be mapped to PDOs.  
If they cannot be set to PDOs, use the support software of the manufacturer or SDO communications to set the torque limits.

For details on mapping data objects, refer to *2-3 PDO Mapping* on page 2-39 and to the *NJ/NX-series CPU Unit Motion Control User's Manual (Cat. No. W507)*.

## ● Changing the Input Parameters

The following input parameters are continuously updated as long as *Enable* is TRUE.

- PositiveEnable (Positive Direction Enable)
- NegativeEnable (Negative Direction Enable)
- PositiveValue (Positive Torque Limit)

- NegativeValue (Negative Torque Limit)

● **Relation to Holding Operation of the MC\_Home or MC\_HomeWithParameter Instruction for OMRON 1S-series Servo Drives or G5-series Servo Drives**

Torque limits that are set in the Servo Drive in advance are used for the Homing Operation Modes, **12: Proximity Reverse Turn/Holding Time** and **13: No Home Proximity Input/Holding Home Input**, to automatically start torque control in the holding direction.



**Precautions for Correct Use**

The automatic torque limit function of the MC\_Home or MC\_HomeWithParameter instruction is not used for servo drives from other manufacturers. Use the MC\_SetTorqueLimit instruction, SDO communications, or the Support Software for the Servo Drive to set suitable values.



**Additional Information**

- The torque limits are continued even after a normal completion of homing.
  - The torque limits are automatically released when an instruction that moves the axis in the opposite direction is executed.
- For details on homing, refer to *MC\_Home* on page 3-18 and *MC\_HomeWithParameter* on page 3-41.

● **Settings for OMRON 1S-series Servo Drives**

To use this instruction, you must set the **Torque Limit - Switch Slection** (3330-01 hex) for the 1S-series Servo Drive with the Sysmac Studio.

- Set the Torque Limit - Switch Selection to 2 to apply a torque limit in the home input detection direction during the holding operation for homing and to use the torque limit directions and values that are set with the MC\_SetTorqueLimit instruction for other operations. In that case, the values of the input variables to the MC\_SetTorqueLimit instruction are ignored during the holding operation for homing.
- If the Torque Limit - Switch Selection is set to 0, the values of the input variables to the MC\_SetTorqueLimit instruction are always used. You must set torque limits that are suitable both for the holding operation during homing and for other operations.

		Torque Limit - Switch Selection (3330-01 hex)	
		2	0
Positive Torque Limit	Homing	The <b>Torque Limit - Positive Torque Limit Value 2</b> (3330-05 hex) for the Servo Drive is used.	The <i>PositiveValue</i> (Positive Torque Limit) for the MC_SetTorqueLimit instruction is used.
	Operations other than Homing	The <i>PositiveValue</i> (Positive Torque Limit) for the MC_SetTorqueLimit instruction is used.	
Negative Torque Limit	Homing	The <b>Torque Limit - Negative Torque Limit Value 2</b> (3330-06 hex) for the Servo Drive is used.	The <i>Negative Value</i> (Negative Torque Limit) for the MC_SetTorqueLimit instruction is used.
	Operations other than Homing	The <i>Negative Value</i> (Negative Torque Limit) for the MC_SetTorqueLimit instruction is used.	

For details, refer to the *AC Servomotors/Servo Drives 1S-series with Built-in EtherCAT Communications User's Manual (Cat. No. I586)* or *AC Servomotors/Servo Drives 1S-series with Built-in EtherCAT Communications and Safety Functionality User's Manual (Cat. No. I621)*.

## ● Settings for OMRON G5-series Servo Drives

To use this instruction, you must use the Support Software of the servo drive to set **Torque Limit Selection** (3521 hex) in the Servo Drive.

- Set the Torque Limit Selection to 6 to apply a torque limit in the home input detection direction during the holding operation for homing and to use the torque limit directions and values that are set with this instruction for other operations.

In that case, the values of the input variables to this instruction are ignored during the holding operation for homing.

- If the Torque Limit Selection is set to 4, the values of the input variables to this instruction are always used. You must set torque limits that are suitable both for the holding operation during homing and for other operations.

		Torque Limit Selection (3521 hex)	
		6 (recommended)	4
Positive Torque Limit	Homing *1	<b>Torque Limit 3</b> (3525 hex) is used.	The smaller of the <i>PositiveValue</i> (Positive Torque Limit) for this instruction and <b>Torque Limit 1</b> (3013 hex) is used.
	Operations other than Homing	The smaller of the <i>PositiveValue</i> (Positive Torque Limit) for this instruction and <b>Torque Limit 1</b> (3013 hex) is used.	
Negative Torque Limit	Homing *1	<b>Torque Limit 4</b> (3526 hex) is used.	The smaller of the <i>NegativeValue</i> (Negative Torque Limit) for this instruction and <b>Torque Limit 2</b> (3522 hex) is used.
	Operations other than Homing	The smaller of the <i>NegativeValue</i> (Negative Torque Limit) for this instruction and <b>Torque Limit 2</b> (3522 hex) is used.	

\*1. Until the torque limit is automatically released.

For details, refer to the *AC Servomotors/Servo Drives G5-series with Built-in EtherCAT Communications User's Manual (Cat. No. I576)* or *AC Servomotors/Servo Drives G5-series with Built-in EtherCAT Communications Linear Motor Type User's Manual (Cat. No. I577)*.

## ● Relationship to the MC\_TorqueControl Instruction

The MC\_SetTorqueLimit and the MC\_TorqueControl instructions can be used together.

## ● Axes in Axes Groups

This instruction can be used for an axis in an enabled axes group.

## ● Relation to CPU Unit Operating Modes

The values that are set with this instruction in RUN mode are also used after the operating mode changes to PROGRAM mode.

## ● Applicable Axes and Execution Condition

- You can use this instruction for a servo axis.

The status of the *Enabled* output variable from this instruction, however, depends on the status of the Servo.

	Servo ON	Servo OFF
Status of Enabled	TRUE	FALSE *1

\*1. If *Enabled* from this instruction is FALSE, the torque limits do not function on the Servo Drive.

- This instruction is acknowledged for a virtual servo axis, but torque is not limited.
- An error occurs if the instruction is executed for an encoder or virtual encoder axis.

### ● Axis Variable Status (Servo Drive Status)

When the internal limit function in the Servo Drive is in operation, *ILA* (Drive Internal Limiting) in *DrvStatus* (Servo Drive Status) in the Axis Variable is TRUE.

This variable gives an OR of the following four: torque limits, velocity limit, drive prohibit inputs, and software limits.

## Timing Chart

The following chart shows the timing of the torque limits.

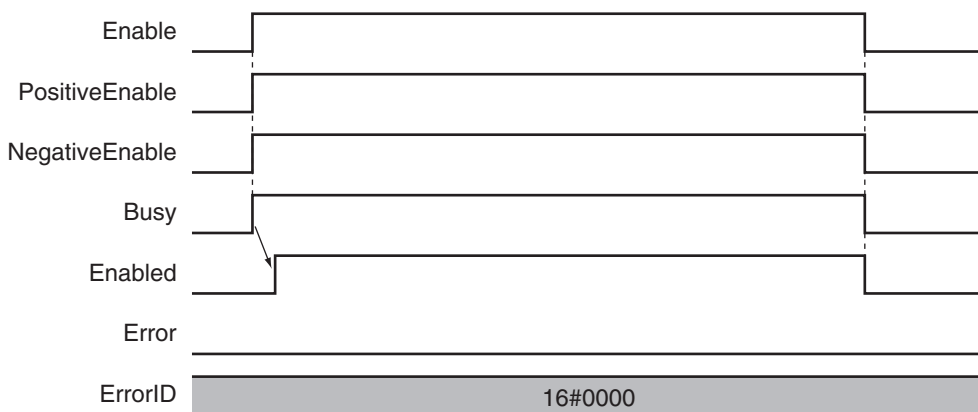

## Re-execution of Motion Control Instructions

You cannot re-execute motion instructions with enable-type inputs.

## Multi-execution of Motion Control Instructions

For details on multi-execution of motion control instructions, refer to the *NJ/NX-series CPU Unit Motion Control User's Manual (Cat. No. W507)*.

### ● Multi-execution of MC\_SetTorqueLimit Instructions

If an instance of this instruction is executed during execution of another instance for the same axis, the instance that is executed last takes priority in processing.

*Enabled* will be TRUE for both instructions.

Concretely, the torque limits of the instance that was executed last are valid. If *Enable* to the instance that was executed last changes to FALSE, the torque limits are disabled.

## Errors

If an error occurs during instruction execution, *Error* will change to TRUE.

You can find out the cause of the error by referring to the value output by *ErrorID* (Error Code).

### ● Timing Chart When Error Occurs

MC\_SetTorqueLimit Instruction

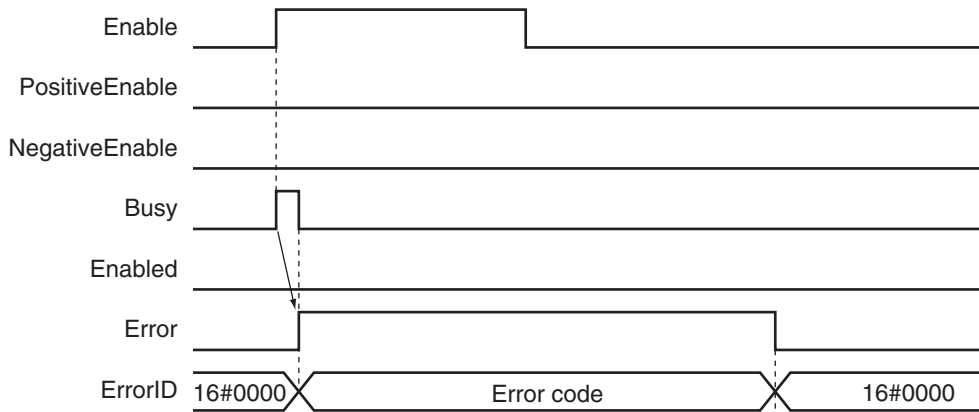

MC\_Reset Instruction

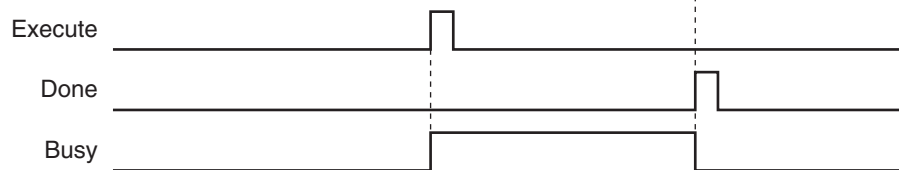

### ● Error Codes

Refer to the *NJ/NX-series Troubleshooting Manual (Cat. No. W503)* for instruction errors.

# MC\_ZoneSwitch

The MC\_ZoneSwitch instruction determines if the command current position or actual current position of an axis is within a specified zone.

Instruction	Name	FB/ FUN	Graphic expression	ST expression
MC_ZoneSwitch	Zone Monitor	FB		<pre>MC_ZoneSwitch_instance (   Axis :=parameter,   Enable :=parameter,   FirstPosition :=parameter,   LastPosition :=parameter,   ReferenceType :=parameter,   Enabled =&gt;parameter,   InZone =&gt;parameter,   Busy =&gt;parameter,   Error =&gt;parameter,   ErrorID =&gt;parameter );</pre>

## Variables

### Input Variables

Name	Meaning	Data type	Valid range	Default	Description
Enable	Enable	BOOL	TRUE or FALSE	FALSE	The instruction is executed while the value of this variable is TRUE.
FirstPosition	First Position	LREAL	Negative number, positive number, or 0	0	Specify the first position of the zone range. <sup>*1</sup> The unit is command units. <sup>*2</sup>
LastPosition	Last Position	LREAL	Negative number, positive number, or 0	0	Specify the last position of the zone range. <sup>*3</sup> The unit is command units. <sup>*2</sup>
ReferenceType	Position Type Selection	_eMC_REFER- ENCE_TYPE	0: _mcCommand 1: _mcFeedback	0 <sup>*4</sup>	Specify the axis information to monitor. 0: Command position (value calculated in the previous task period <sup>*5</sup> ) 1: Actual position (value obtained in the same task period <sup>*5</sup> )

\*1. Set a value that is smaller than the last position.

\*2. Refer to *Unit Conversion Settings* in the *NJ/NX-series CPU Unit Motion Control User's Manual (Cat. No. W507)* for information on command units.

\*3. Set a value that is larger than the first position.

\*4. The default value for an enumeration variable is actually not the number, but the enumerator.

\*5. The task period is the primary period if the task is the primary periodic task and the task period of the priority-5 periodic task if the task is the priority-5 periodic task.

## Output Variables

Name	Meaning	Data type	Valid range	Description
Enabled	Enable	BOOL	TRUE or FALSE	TRUE while the axis is being controlled.
InZone	In Zone	BOOL	TRUE or FALSE	TRUE when the axes position is within the zone.
Busy	Executing	BOOL	TRUE or FALSE	TRUE when the instruction is acknowledged.
Error	Error	BOOL	TRUE or FALSE	TRUE while there is an error.
ErrorID	Error Code	WORD	*1	Contains the error code when an error occurs. A value of 16#0000 indicates normal execution.

\*1. The upper four digits of the event code give the error code for ErrorID. Refer to the *NJ/NX-series Troubleshooting Manual (Cat. No. W503)* for the event codes.

### ● Output Variable Update Timing

Name	Timing for changing to TRUE	Timing for changing to FALSE
Enabled	When <i>Enable</i> changes to TRUE.	When <i>Enable</i> changes to FALSE.
InZone	When the zone is entered.	<ul style="list-style-type: none"> <li>When the zone is exited.</li> <li>When <i>Enable</i> changes to FALSE.</li> </ul>
Busy	When <i>Enable</i> changes to TRUE.	<ul style="list-style-type: none"> <li>When <i>Error</i> changes to TRUE.</li> <li>When <i>Enable</i> changes to FALSE.</li> </ul>
Error	When there is an error in the execution conditions or input parameters for the instruction.	When the error is cleared.

## In-Out Variables

Name	Meaning	Data type	Valid range	Description
Axis	Axis	_sAXIS_REF	---	Specifies the axis. *1

\*1. Specify a user-defined Axis Variable that was created in the Axis Basic Settings of the Sysmac Studio (default: MC\_Axis\*) or a system-defined axis variable name (\_MC\_AX[\*], \_MC1\_AX[\*], or \_MC2\_AX[\*]).  
If you use Sysmac Studio version 1.29 or higher, you can specify the system-defined axis variable name for AT specification of a user-defined variable. This will allow you to specify the user-defined variable.  
If you use Sysmac Studio version 1.28 or lower, do not specify any user-defined variable created in the variable table.

## Function

- If the axis command position or actual current position is above the *FirstPosition* and below the *LastPosition* (i.e., if it is in the specified zone) when *Enable* of this instruction is TRUE, the output variable *InZone* will change to TRUE.  
You can use *ReferenceType* (Position Type Selection) to set either the command position or actual position as the axis information to monitor.
- You can perform zone monitoring for any axis type.
- If *FirstPosition* or *LastPosition* is changed while *Enable* is TRUE, the new value is applied in the period in which it is changed.

- You can set multiple zones for one axis, and these zones can overlap. You can also set zones outside the software limits.



### Precautions for Correct Use

If *FirstPosition* or *LastPosition* contains a non-terminating decimal number, e.g., resulting from division, error may cause unexpected processing results.

## Instruction Details

Set the *FirstPosition* and *LastPosition* so that the following relationships are established for the Counter Mode. An error occurs if the relationship is not established.

### ● Linear Mode

Set *FirstPosition* to the same value or a smaller value than *LastPosition*.

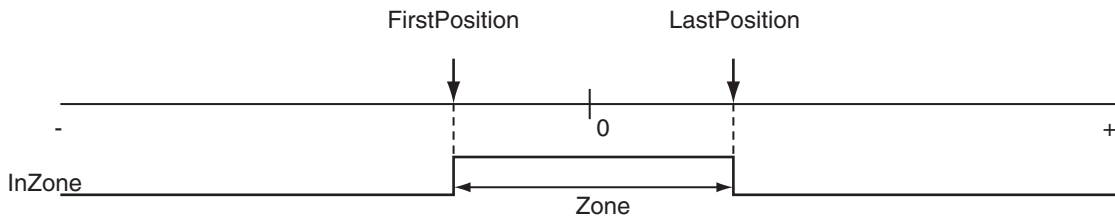

### ● Rotary Mode

In **Rotary Mode**, there is a difference depending on whether the modulo maximum position and modulo minimum position setting values are included.

#### When Maximum/Minimum Position Is Not Included

Set *FirstPosition* to the same value or a smaller value than *LastPosition*.

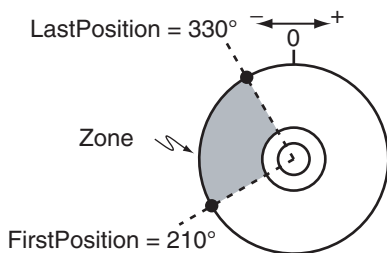
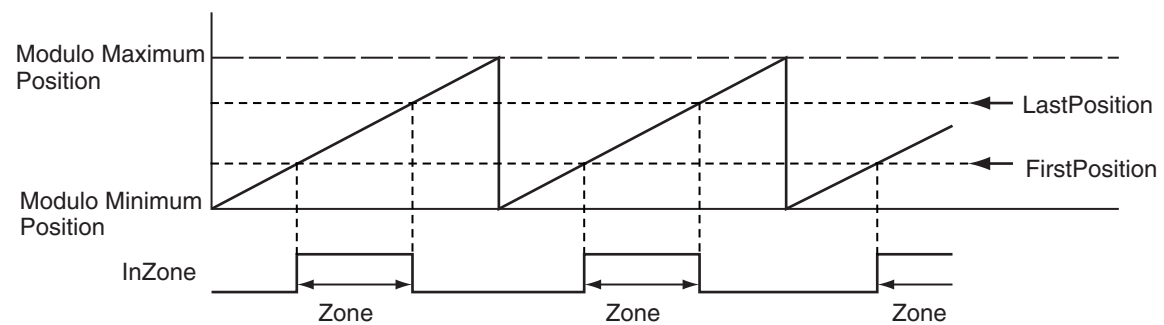

● : The positions indicated with filled dots are included.

#### When Maximum/Minimum Position Is Included



Set *FirstPosition* to a larger value than *LastPosition*.

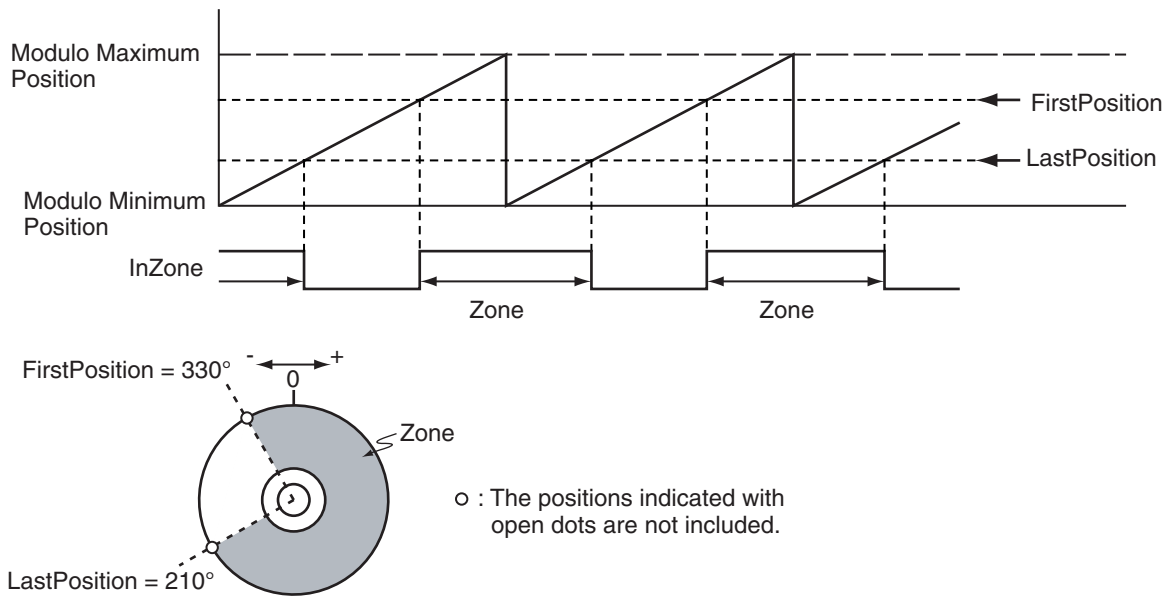

● **ReferenceType (Position Type Selection)**

You can select one of the following position types.

- **\_mcCommand**: Command position (value calculated in the previous task period)  
The master axis command position that was calculated in the previous task period is used for the current period.  
The command value that was calculated for the master axis in the last periodic task is used to calculate the command position of the slave axis in the current period.
- **\_mcFeedback**: Value obtained in the same task period  
The actual position of the master axis that was obtained in the same task period is used.



**Precautions for Correct Use**

Here, the task period is the primary period if the task is the primary periodic task and the task period of the priority-5 periodic task if the task is the priority-5 periodic task. In the same way, the periodic task is the primary periodic task or the priority-5 periodic task.

● **Relationship between Axis Types and Position Types**

The relationship between the axis types that you can monitor and position types that is monitored is shown below.

Axis Type	ReferenceType	
	_mcCommand	_mcFeedback
Servo axis	OK	OK
Encoder axis	No*1	OK
Virtual servo axis	OK	OK
Virtual encoder axis	No*1	OK

\*1. A Position Type Selection Out of Range error (error code: 5430 hex) occurs when the instruction is executed.

## Timing Charts

### ● When the Zone Is Entered during Operation or When *Enable* Changes to FALSE Within the Zone

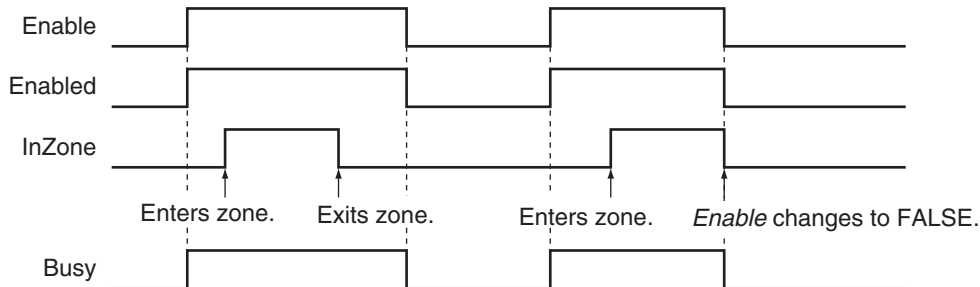

### ● When Inside the Zone before the Instruction Is Executed and Then the Zone Is Exited

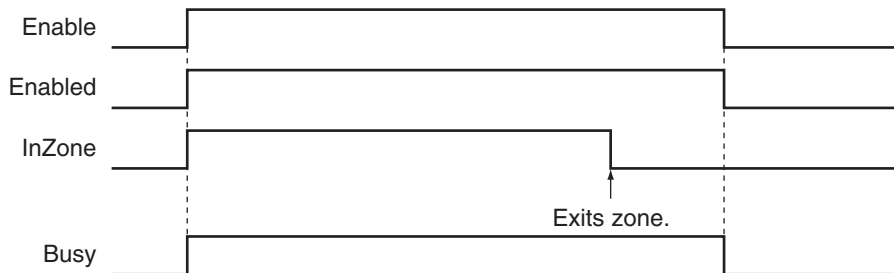

## Re-execution of Motion Control Instructions

You cannot re-execute motion instructions with enable-type inputs.

## Multi-execution of Motion Control Instructions

This instruction is executed independently from other instructions. The restrictions for multi-execution of motion instructions do not apply.

For details on multi-execution of motion control instructions, refer to the *NJ/NX-series CPU Unit Motion Control User's Manual (Cat. No. W507)*.

## Errors

If an error occurs during instruction execution, *Error* will change to TRUE.

You can find out the cause of the error by referring to the value output by *ErrorID* (Error Code).

● **Timing Chart When Error Occurs**

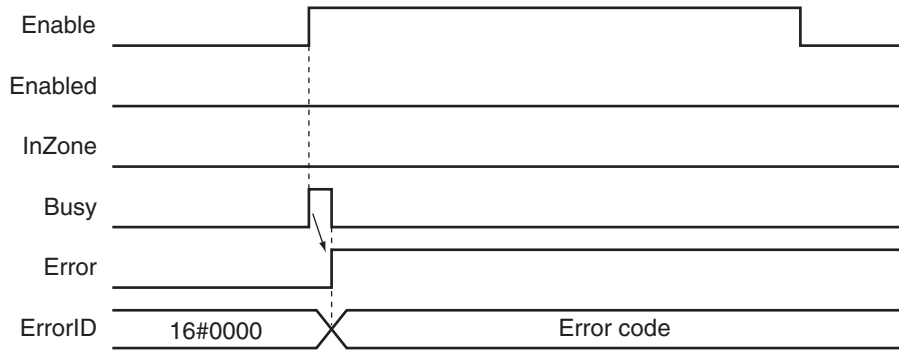

● **Error Codes**

Refer to the *NJ/NX-series Troubleshooting Manual (Cat. No. W503)* for instruction errors.

# MC\_TouchProbe

The MC\_TouchProbe instruction records the position of an axis when a trigger signal occurs.

Instruction	Name	FB/ FUN	Graphic expression	ST expression
MC_TouchProbe	Enable External Latch	FB		<pre>MC_TouchProbe_instance (   Axis :=parameter,   TriggerInput :=parameter,   TriggerVariable :=parameter,   Execute :=parameter,   WindowOnly :=parameter,   FirstPosition :=parameter,   LastPosition :=parameter,   ReferenceType :=parameter,   StopMode :=parameter,   Done =&gt;parameter,   Busy =&gt;parameter,   RecordedPosition =&gt;parameter,   CommandAborted =&gt;parameter,   Error =&gt;parameter,   ErrorID =&gt;parameter );</pre>

## Variables

### Input Variables

Name	Meaning	Data type	Valid range	De- fault	Description
Execute	Execute	BOOL	TRUE or FALSE	FALS E	The instruction is executed when the value of this variable changes to TRUE.
WindowOnly	Window Only	BOOL	TRUE or FALSE	FALS E	Specify whether to enable or disable the window mask.
FirstPosition	First Position	LREAL	Negative number, positive number, or 0	0	Specify the position to start accepting the trigger. Use the type of position that is specified in <i>ReferenceType</i> (Position Type Selection). <sup>*1</sup> The unit is command units. <sup>*2</sup>
LastPosition	Last Position	LREAL	Negative number, positive number, or 0	0	Specify the position to stop accepting the trigger. Use the type of position that is specified in <i>ReferenceType</i> (Position Type Selection). <sup>*1</sup> The unit is command units. <sup>*2</sup>

Name	Meaning	Data type	Valid range	Default	Description
ReferenceType (Reserved)	Position Type Selection	_eMC_REFER- ENCE_TYPE	1: _mcFeedback	1*3	(Reserved)
StopMode	Stopping Mode Selection	_eMC_STOP_MOD E	1: _mcImmediate- Stop 4: _mcNonStop	4*3	Specify the stopping method. 1: Perform an immediate stop 4: Do not stop

\*1. Refer to *WindowOnly* on page 3-370 for details.

\*2. Refer to *Unit Conversion Settings* in the *NJ/NX-series CPU Unit Motion Control User's Manual (Cat. No. W507)* for information on command units.

\*3. The default value for an enumeration variable is actually not the number, but the enumerator.

## Output Variables

Name	Meaning	Data type	Valid range	Description
Done	Done	BOOL	TRUE or FALSE	TRUE when the instruction is completed.
Busy	Executing	BOOL	TRUE or FALSE	TRUE when the instruction is acknowledged.
RecordedPosition	Latched Position	LREAL	Negative number, positive number, or 0	Contains the latched position. The unit is in command units. *1
CommandAborted	Command Aborted	BOOL	TRUE or FALSE	TRUE when the instruction is aborted.
Error	Error	BOOL	TRUE or FALSE	TRUE while there is an error.
ErrorID	Error Code	WORD	*2	Contains the error code when an error occurs. A value of 16#0000 indicates normal execution.

\*1. Refer to *Unit Conversion Settings* in the *NJ/NX-series CPU Unit Motion Control User's Manual (Cat. No. W507)* for information on command units.

\*2. The upper four digits of the event code give the error code for ErrorID. Refer to the *NJ/NX-series Troubleshooting Manual (Cat. No. W503)* for the event codes.

### ● Output Variable Update Timing

Name	Timing for changing to TRUE	Timing for changing to FALSE
Done	<ul style="list-style-type: none"> <li>When the latched position is recorded and the instruction is completed after the trigger signal occurs.</li> <li>If stopping is specified, when the axis stops at the latched position after the latched position is recorded and the instruction is completed after the trigger signal occurs.</li> </ul>	<ul style="list-style-type: none"> <li>When <i>Execute</i> is TRUE and changes to FALSE.</li> <li>After one period when <i>Execute</i> is FALSE.</li> </ul>
Busy	When <i>Execute</i> changes to TRUE.	<ul style="list-style-type: none"> <li>When <i>Done</i> changes to TRUE.</li> <li>When <i>Error</i> changes to TRUE.</li> <li>When <i>CommandAborted</i> changes to TRUE.</li> </ul>

Name	Timing for changing to TRUE	Timing for changing to FALSE
CommandAborted	<ul style="list-style-type: none"> <li>When this instruction is aborted because another motion control instruction was executed with the Buffer Mode set to <b>Aborting</b>.</li> <li>When this instruction is canceled due to an error.</li> <li>If <i>StopMode</i> is set to <b>_mcImmediateStop</b>, when a change is made to a mode other than CSP Mode during execution.*1</li> <li>When the slave is disconnected.</li> <li>When a slave communications error occurs (except during process data communications).</li> <li>When the MC_AbortTrigger instruction is executed.</li> </ul>	<ul style="list-style-type: none"> <li>When <i>Execute</i> is TRUE and changes to FALSE.</li> <li>After one period when <i>Execute</i> is FALSE.</li> </ul>
Error	When there is an error in the execution conditions or input parameters for the instruction.	When the error is cleared.

\*1. If you use an NX-series CPU Unit, there are no restrictions in the control mode. Therefore, *CommandAborted* does not change to TRUE even in modes other than CSP Mode.

## In-Out Variables

Name	Meaning	Data type	Valid range	Description
Axis	Axis	_sAXIS_REF	---	Specify the axis. *1
TriggerInput	Trigger Input Condition	_sTRIGGER_REF	---	Set the trigger condition. *2
TriggerVariable	Trigger Variable	BOOL	TRUE or FALSE	Specify a trigger input variable when the Controller Mode is specified for the trigger mode.

\*1. Specify a user-defined Axis Variable that was created in the Axis Basic Settings of the Sysmac Studio (default: MC\_Axis\*) or a system-defined axis variable name (\_MC\_AX[\*], \_MC1\_AX[\*], or \_MC2\_AX[\*]).

If you use Sysmac Studio version 1.29 or higher, you can specify the system-defined axis variable name for AT specification of a user-defined variable. This will allow you to specify the user-defined variable.

If you use Sysmac Studio version 1.28 or lower, do not specify any user-defined variable created in the variable table.

\*2. Define a user-defined variable with a data type of \_sTRIGGER\_REF.

### ● \_sTRIGGER\_REF

Name	Meaning	Data type	Valid range	Function
Mode	Mode	_eMC_TRIGGER_MODE	0: _mcDrive 1: _mcController	Specify the trigger mode. 0: Drive Mode 1: Controller Mode
LatchID	Latch ID Selection	_eMC_TRIGGER_LATCH_ID	0: _mcLatch1 1: _mcLatch2	Specify which of the two latch functions to use in <b>Drive Mode</b> . 0: Latch 1 1: Latch 2
InputDrive	Trigger Input Signal	_eMC_TRIGGER_INPUT_DRIVE	0: _mcEncoderMark 1: _mcEXT	Specify the Servo Drive trigger signal to use in <b>Drive Mode</b> . 0: Z-phase signal 1: External input

## Function

- Latching is used to control positioning based on the point where a trigger signal occurs, such as a signal from a sensor input. The position of the axis is recorded (i.e., latched) when the trigger signal occurs.
- The position of the axis that is specified with *Axis* is output to *RecordedPosition* (Latched Position) according to the trigger settings.  
As trigger settings, you can specify *TriggerInput* (Trigger Input Condition), *WindowOnly*, *FirstPosition*, *LastPosition*, and *StopMode*.
- The output value of *RecordedPosition* (Latched Position) is held until the axis position is recorded again by the same MC\_TouchProbe (Enable External Latch) instance.

### ● Mapping Data Objects

You must map the following object data when the MC\_TouchProbe (Enable External Latch) instruction is executed with *Mode* set to **Drive Mode**.

Mapping is performed in the **Detailed Settings** Area of the Axis Basic Settings Display of the Sysmac Studio.

#### Axes Type Set to Servo Axis

- Touch probe function (60B8 hex)
- Touch probe status (60B9 hex)
- Touch probe pos1 pos value (60BA hex)
- Touch probe pos2 pos value (60BC hex)

#### Axes Type Set to Encoder Axis

- Touch probe function (4020 hex)
- Software Switch of Encoder's Input Slave (4020 hex)
- Touch probe status (4030 hex)
- Touch probe pos1 pos value (4012 hex)
- Touch probe pos2 pos value (4013 hex)
- Status of Encoder's Input Slave (4030 hex)

If even one of the required objects is not set, a Process Data Object Setting Missing error (error code 3461 hex) occurs.

For details on mapping data objects, refer to *2-3 PDO Mapping* on page 2-39 and to the *NJ/NX-series CPU Unit Motion Control User's Manual (Cat. No. W507)*.

Refer to *I/O Entry Mappings* in the *NX-series Position Interface Units User's Manual (Cat. No. W524)* for information on using the NX-series Position Interface Units.

Refer to *Fixed PDO Mapping* in the *GX-series EtherCAT Slave Units User's Manual (Cat. No. W488)* for information on using encoder input slaves.

## Instruction Details

This section describes the instruction in detail.

### ● Specifying Axis

- Specify the axis for which to latch the position to *Axis*.

- If the specified *Axis* is enabled by the MC\_GroupEnable (Enable Axes Group) instruction, the MC\_TouchProbe (Enable External Latch) instruction causes an error and is not executed.
- For each axis, you can specify *LatchID* to execute up to two MC\_TouchProbe (Enable External Latch) instructions at the same time.
- *LatchID* is also used to specify the latch to abort for the MC\_AbortTrigger (Disable External Latch) instruction.



#### Additional Information

- Latching a position is also possible if an encoder axis that is connected to an OMRON GX-series GX-EC02□□ EtherCAT Encoder Input Slave is used.
- If you use an NX-series Pulse Output Unit, you can also perform latching with this instruction. Refer to the *NX-series Position Interface Units User's Manual (Cat. No. W524)* for details.

## ● Trigger Input Condition

Select the trigger conditions with *Mode*, *LatchID*, and *InputDrive* of the *TriggerInput* (Trigger Input Conditions) variable.

### Mode

- *Mode* can be set to **Drive Mode** to specify a signal from the Servo Drive or other device as the trigger, or to **Controller Mode** to specify a trigger with *TriggerVariable*.
- The trigger occurs on the rising edge of the trigger signal. The axis position is latched on the first trigger (FALSE to TRUE) after the MC\_TouchProbe instruction is executed.
- While this instruction is *Busy* (Executing), a change in *TriggerVariable* is taken as a trigger even if *Execute* is FALSE.



#### Additional Information

Set *Mode* to **\_mcDrive** (Servo Drive Mode) if you use an OMRON GX-series GX-EC02□□ EtherCAT Encoder Input Slave.

### Drive Mode

For trigger detection and latching of the actual position, the latched actual position is more precise in **Drive Mode** (which is a function of the Servo Drive or other device) than it is in **Controller Mode**.

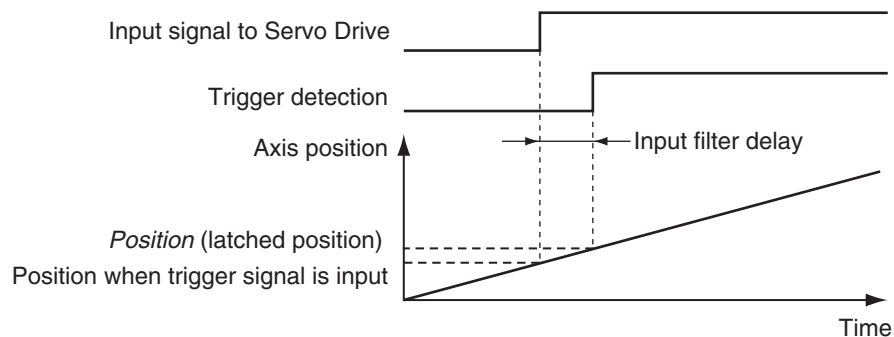





### Precautions for Correct Use

- When using **Drive Mode**, make sure that you connect the latch signal to the *LatchID* that you are going to use.
- The width of the latch signal depends on the performance of the Servo Drive or other device and other factors.



### Additional Information

Set *InputDrive* to **\_mcEXT** (External Input) if you use an OMRON GX-series GX-EC02□□ EtherCAT Encoder Input Slave.

The OMRON GX-series GX-EC02□□ EtherCAT Encoder Input Slaves cannot latch on the Z phase. If you specify **\_mcEncoderMark** (Z phase), an error occurs when the instruction is executed. *Error* changes to TRUE and a Process Data Object Setting Missing error (error code: 3461 hex) is output to *ErrorID* when the instruction is executed.

### Controller Mode

- You can specify a BOOL variable as the trigger in **Controller Mode**.
- Specify the BOOL variable that you want to use as a trigger for *TriggerVariable*.
- The **Controller Mode** causes a longer delay compared to the **Drive Mode**. This is due to the I/O refresh delay that occurs when the trigger input signal is updated in the BOOL variable.

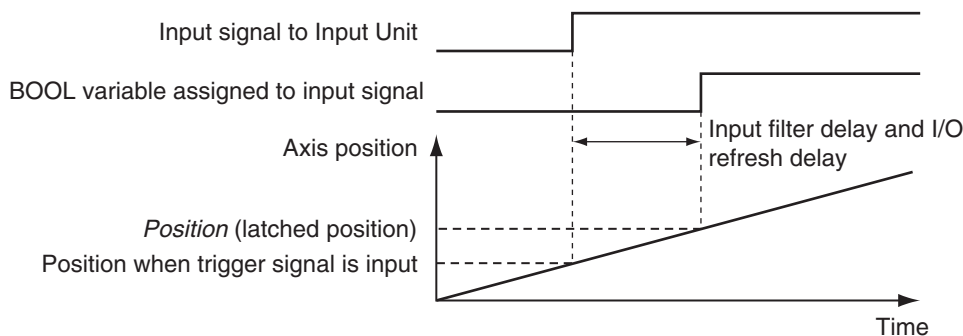

### Precautions for Correct Use

If you use **Controller Mode**, the latch is performed each task period interval. Therefore, the trigger variable must remain TRUE for at least one task period interval. Also, one task period is required between when the trigger variable changes to TRUE and the MC Function Module processes the latch. Here, the task period is the primary period if the task is the primary periodic task and the task period of the priority-5 periodic task if the task is the priority-5 periodic task.

### LatchID

- You can execute up to two MC\_TouchProbe instructions per axis. Use *LatchID* to specify which of the two latches to use.
- If a LatchID specified for the same axis is already being executed, only the last instruction is valid. *CommandAborted* of the previous instruction will change to TRUE.
- *LatchID* indicates latch circuit 1 and latch circuit 2 in the Servo Drive or other device.

For information on *LatchID*, refer to the *NJ/NX-series CPU Unit Motion Control User's Manual (Cat. No. W507)*.



### Additional Information

The enumerators correspond to the signal names of the OMRON GX-series GX-EC02□□ EtherCAT Encoder Input Slave as shown below.

Enumerator	Signal name on Encoder Input Terminal
_mcLatch1	External latch input A
_mcLatch2	External latch input B

### InputDrive

- You can select `_mcEncoderMark` (Z phase) or `_mcEXT` (External Input) as the trigger.
- Select `_mcEncoderMark` (Z phase) to use the Z phase of the Servo Drive or other device as the trigger.  
Select `_mcEXT` to use an external signal input to the Servo Drive as the trigger.
- For an OMRON 1S-series Servo Drive, there are two options for `_mcEXT`: Ext1, and Ext2. For an OMRON G5-series Servo Drive, there are three options for `_mcEXT`: Ext1, Ext2, and Ext3. Use the Sysmac Studio to make the setting.  
You can use the same setting for two triggers in the Servo Drive.

### ● WindowOnly

- *WindowOnly* specifies whether the window is enabled or disabled.
- When *WindowOnly* is FALSE, triggers are detected for all axis positions.
- When *WindowOnly* is TRUE, triggers are detected only when the axis position is within the range specified by *FirstPosition* and *LastPosition*.

The following timing chart shows the difference in operation depending on the *WindowOnly* setting.

#### **WindowOnly Set to FALSE**

The axis position when the first trigger occurs after *Execute* changes to TRUE is output to *RecordedPosition* (Latched Position).

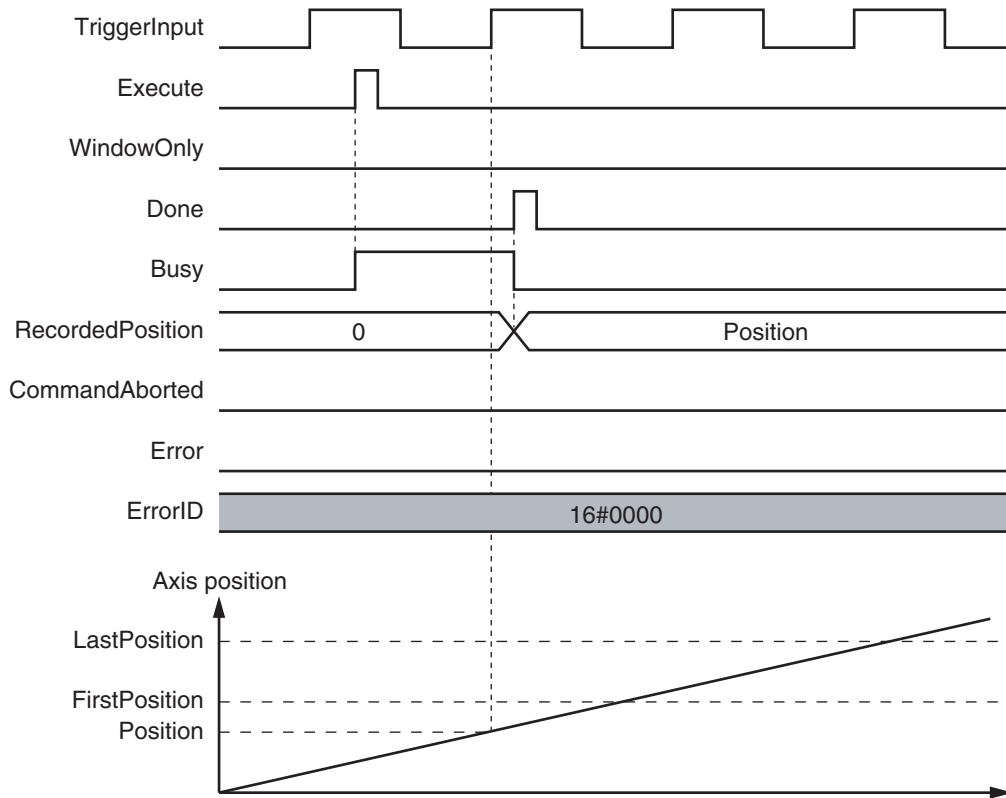

**WindowOnly Set to TRUE**

Only trigger inputs within the window are detected to latch the axis position.

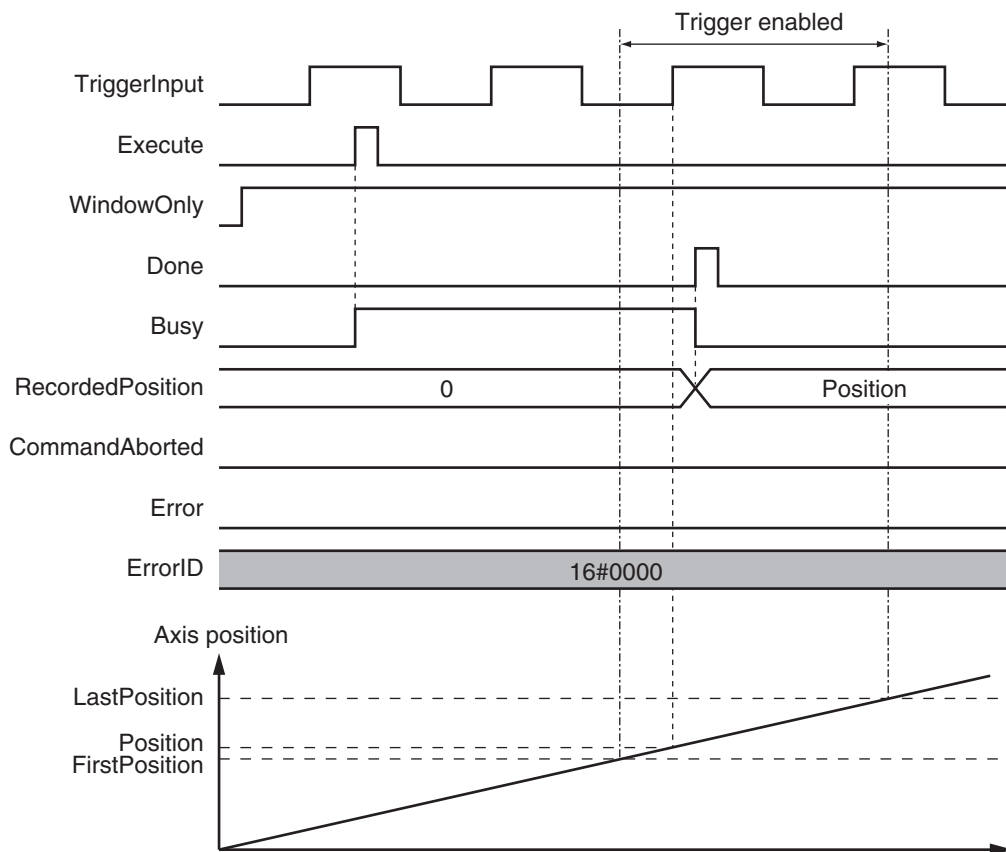



## Precautions for Correct Use

- Latching is not possible immediately after *WindowOnly* changes to TRUE and until the latch function is activated.
- Time is needed until the latch function is activated. If the effective range for *WindowOnly* is too small, latching is not possible. The range in which latching is possible depends on the performance of the Servo Drive, Encoder Input Terminal, or Position Interface Unit, and on EtherCAT communications.

The range that is defined by *FirstPosition* and *LastPosition* depends on the Count Mode, as given below.

### Linear Mode

- The valid range of the window is as follows:

*FirstPosition* must be less than or equal to the window range and the window range must be less than or equal to *LastPosition*.

- An error will occur if the *FirstPosition* is greater than the *LastPosition*.
- An error will also occur if a position beyond the position range of **Linear Mode** is specified.
- *FirstPosition* and *LastPosition* are LREAL variables. Do not set them to the same values. Refer to *Treatment of REAL and LREAL Data* on page 1-13 for information on LREAL data.

The window only range in **Linear Mode** is shown below.

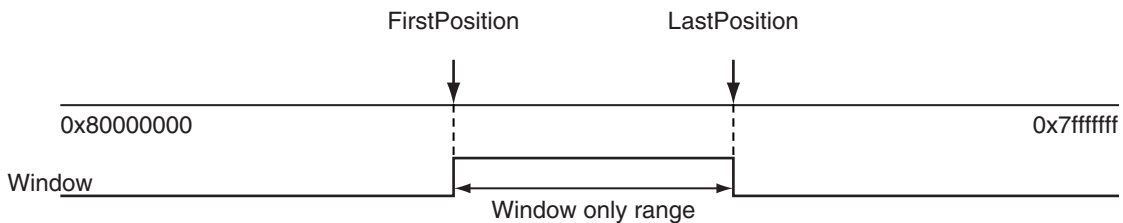

**Note** The window only range can include the *FirstPosition* and *LastPosition*.

### Rotary Mode

- The *FirstPosition* can be less than, equal to, or greater than the *LastPosition*.
- If the *FirstPosition* is greater than the *LastPosition*, the setting range includes the modulo maximum position and modulo minimum position setting values.
- An error will occur if you specify a value beyond the modulo maximum position and modulo minimum position setting values.

$FirstPosition \leq LastPosition$

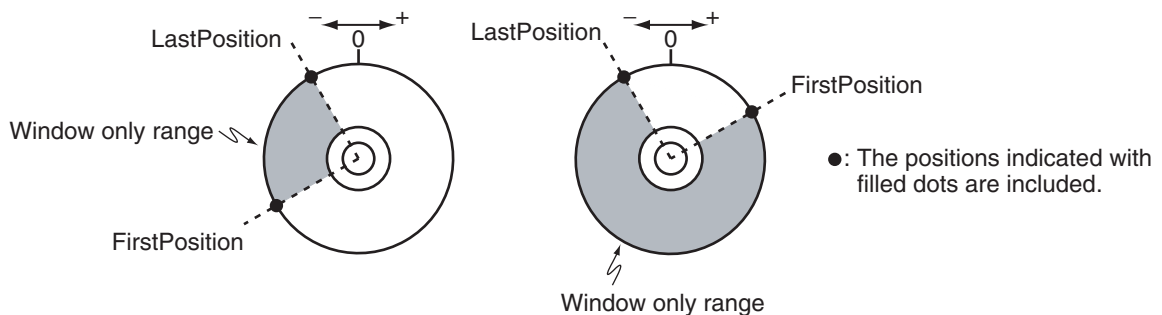

FirstPosition > LastPosition

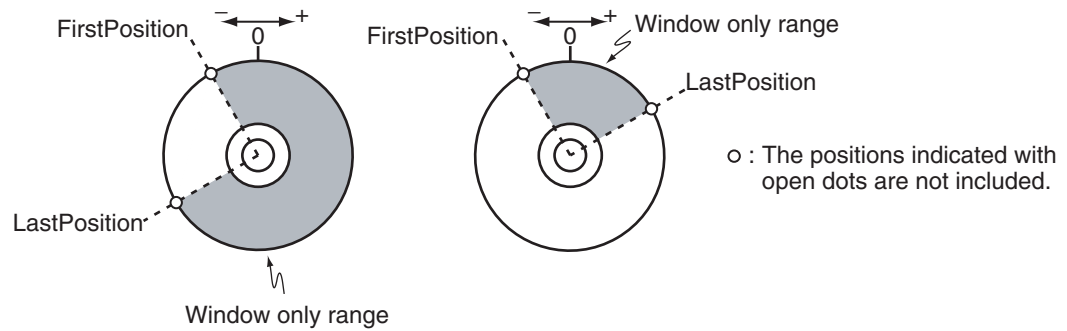

## ● StopMode

- You can specify the *StopMode* for the specified *Axis* when a trigger occurs.
- If *\_mcNonStop* is specified, the axis will not stop even if a trigger occurs.
- If *\_mclmmediateStop* is specified, the axis stops at the latched position when a trigger occurs. *CommandAborted* of the instruction that was moving the axis changes to TRUE due to this stop.
- For *\_mclmmediateStop*, *Done* changes to TRUE as soon as the axis command stops. *Busy* is TRUE until the axis stops at the latched position.
- An in-position check is not performed when stopping for *\_mclmmediateStop*.



### Additional Information

- When an OMRON 1S-series Servo Drive is used, the operation will be the same as those described in below for CPU Units with unit version 1.10 or later, regardless of actual unit version of the CPU Unit that you use.
- When an OMRON G5-series Servo Drive is used, the operation will differ depending on the unit version of the CPU Unit that you use, as described in below.

### CPU Units with Unit Version 1.10 or Later

- If an axis error occurs for the axis for which *\_mclmmediateStop* (Immediate Stop) is specified and a trigger occurs before stopping the axis is completed, the axis will continue to decelerate to a stop. Also, the trigger will cause *CommandAborted* (Instruction Aborted) to change to TRUE.

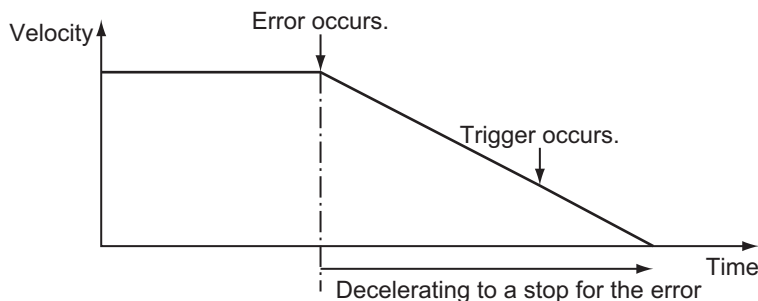



### Precautions for Correct Use

- The MC Function Module performs stop processing for `_mclImmediateStop` (Immediate Stop). The axis will stop beyond the latched position, and the axis will then return to the latched position for a command from the Controller.
- If you use `_mclImmediateStop` (Immediate Stop) with a high command velocity, the distance to return to the latched position will be long. Make sure that the command velocity is not too high.
- Specify `_mcNonStop` (No Stop) for an encoder axis. If `_mclImmediateStop` (Immediate Stop) is specified, *Error* will change to TRUE when the instruction is executed. At the same time, an Enable External Latch Instruction Execution Disabled error (error code: 5492 hex) is output to *ErrorID*.

### CPU Units with Unit Version 1.09 or Earlier

- If an axis error occurs for an axis for which `_mclImmediateStop` (Immediate Stop) is specified and a trigger occurs before the axis is stopped, an immediate stop is performed for the axis by the OMRON G5-series Servo Drive. Also, the trigger will cause *CommandAborted* (Instruction Aborted) to change to TRUE.
- When the MC Function Module detects that the OMRON G5-series Servo Drive has stopped, it stops the motor immediately. The dotted line in the following figure shows the target path when a trigger does not occur.

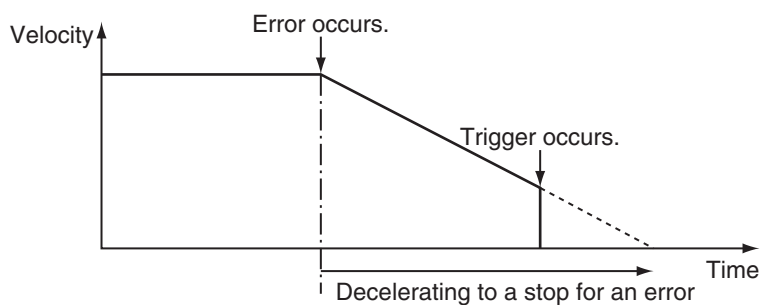



### Precautions for Correct Use

- `_mclImmediateStop` (Immediate Stop) functions in CSP Mode.
- If `_mclImmediateStop` (Immediate Stop) is specified in CSV/CST Mode, an Enable External Latch Instruction Execution Disabled error (error code 5492 hex) occurs when the instruction is executed. If you change to CSV/CST Mode during execution for `_mclImmediateStop` (Immediate Stop), `CommandAborted` changes to TRUE.
- For `_mclImmediateStop` (Immediate Stop), the function of the Servo Drive or NX-series Pulse Output Unit is used to stop if an OMRON G5-series Servo Drive or NX-series Pulse Output Unit is used.  
The MC Function Module processes the stop if an OMRON 1S-series Servo Drive or a servo drive from another manufacturer is used.  
In either case, the axis will stop beyond the latched position, and the axis will then return to the latched position for a command from the Controller.
- If you use `_mclImmediateStop` (Immediate Stop) with a high command velocity, the distance to return to the latched position will be long.  
Make sure that the command velocity is not too high.
- Specify `_mcNonStop` (No Stop) for an encoder axis. If `_mclImmediateStop` (Immediate Stop) is specified, `Error` will change to TRUE when the instruction is executed. At the same time, an Enable External Latch Instruction Execution Disabled error (error code: 5492 hex) is output to `ErrorID`.
- If `_mclImmediateStop` (Immediate Stop) is used and both of the following processes are executed in the same control period, an OMRON G5-series Servo Drive enters the Target Ignore state.
  - a) Counter latch processing in the Servo Drive when the latch signal turns ON
  - b) Latch release processing when `CommandAborted` changes to TRUE for the MC\_TouchProbe (Enable External Latch) instruction

Make sure that `CommandAborted` for the instruction does not change to TRUE when the latch signal turns ON.

### ● Axis Variable Status

If `_mclImmediateStop` is specified for `StopMode`, `Status.Stopping` (Deceleration Stopping) in the Axis Variable is TRUE during stop processing for the trigger.

## Aborting the Instruction

End the MC\_TouchProbe (Enable External Latch) instruction with the MC\_AbortTrigger (Disable External Latch) instruction.

Specify the `Axis` and the `LatchID` (Latch ID Selection) to stop for the MC\_AbortTrigger instruction and execute it to stop the axis.

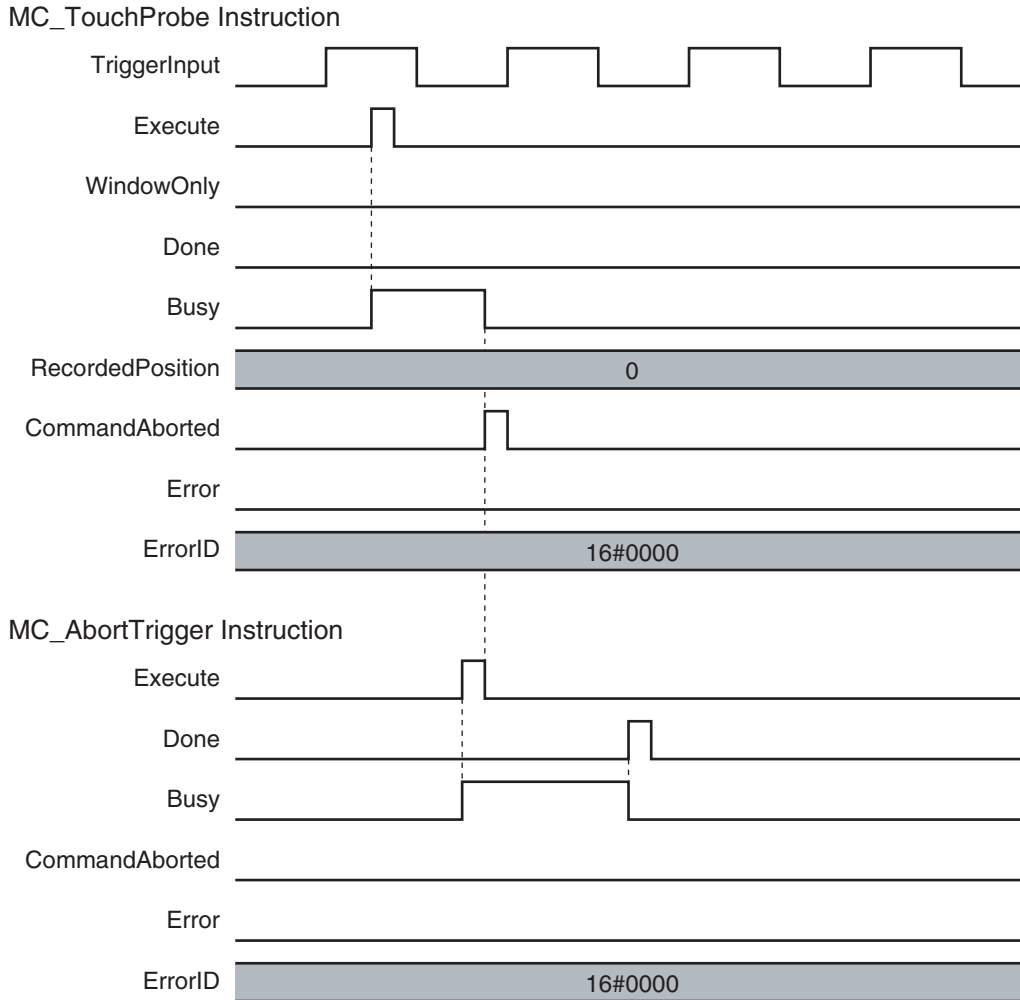

## Re-execution of Motion Control Instructions

This instruction cannot be re-executed.

A Motion Control Instruction Re-execution Disabled error (error code: 543B hex) occurs if re-execution is attempted.

An error occurs if *Execute* changes to TRUE again before the **MC\_TouchProbe** instance completes reading *RecordedPosition* (Latched Position).



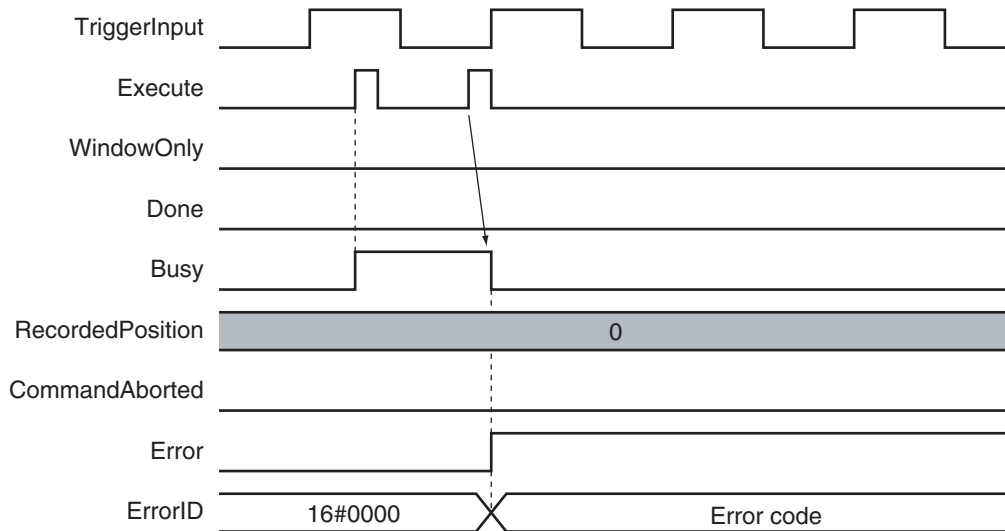

## Multi-execution of Motion Control Instructions

For details on multi-execution of motion control instructions, refer to the *NJ/NX-series CPU Unit Motion Control User's Manual (Cat. No. W507)*.

### ● Execution during Execution of Other Instructions

You can execute only one trigger at a time for a single *LatchID* on the same *Axis*.

If you execute another MC\_TouchProbe (Enable External Latch) instance for the same *LatchID* while an MC\_TouchProbe (Enable External Latch) instruction is in execution, *CommandAborted* of the first instruction changes to TRUE and the second instruction is executed.

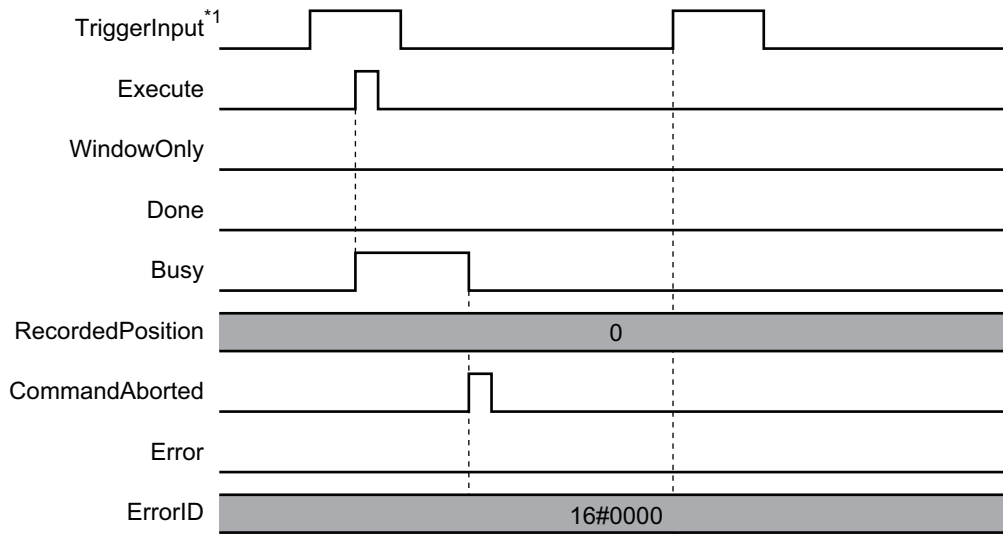
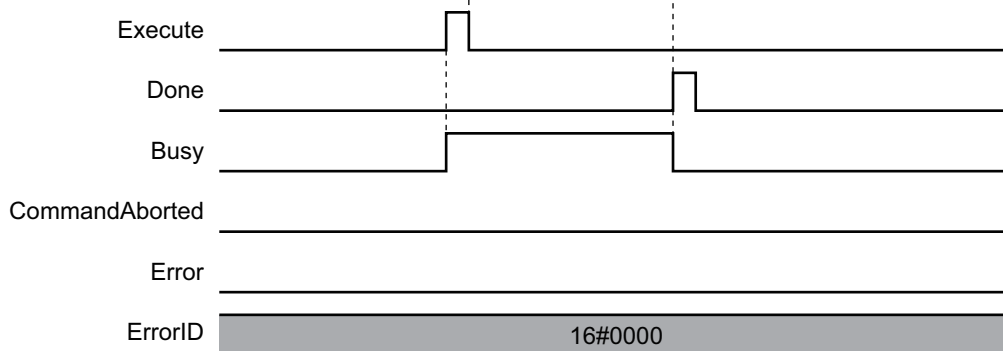
**MC\_TouchProbe A****MC\_TouchProbe B**

\*1. Here, the trigger input signal of the Servo Drive or other device is used.

**Additional Information**

If `_mclImmediateStop` is specified for `StopMode`, `CommandAborted` for the second instruction changes to TRUE after the axis stops for the trigger.

**Errors**

If an error occurs during instruction execution, `Error` will change to TRUE.

You can find out the cause of the error by referring to the value output by `ErrorID` (Error Code).

## ● Timing Chart When Error Occurs

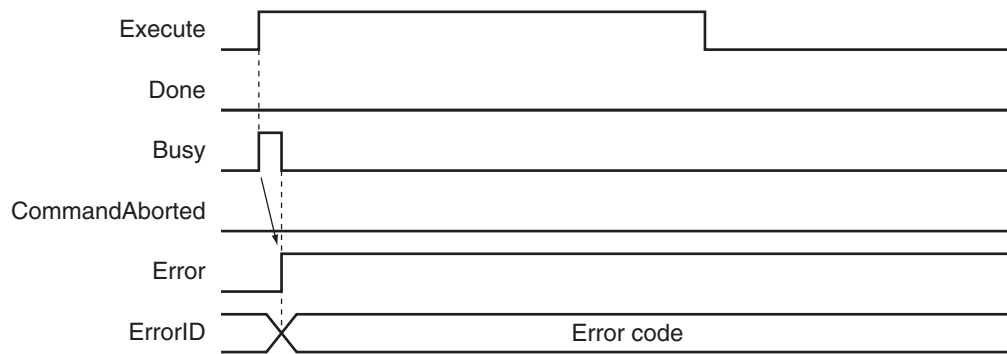

## ● Error Codes

Refer to the *NJ/NX-series Troubleshooting Manual (Cat. No. W503)* for instruction errors.

## Sample Programming

This section shows sample programming for position latching control by an external sensor.

## Parameter Settings

The minimum settings required for this sample programming are given below.

## ● Axis Parameters

### Axis Type

Axis	Axis Type
Axis 1	Servo axis

### Count Mode

Axis	Count Mode
Axis 1	Rotary Mode

### Ring Counter

Axis	Modulo maximum position	Modulo minimum position
Axis 1	360	0

### Unit of Display

Axis	Unit of Display
Axis 1	degree

## Operation Example

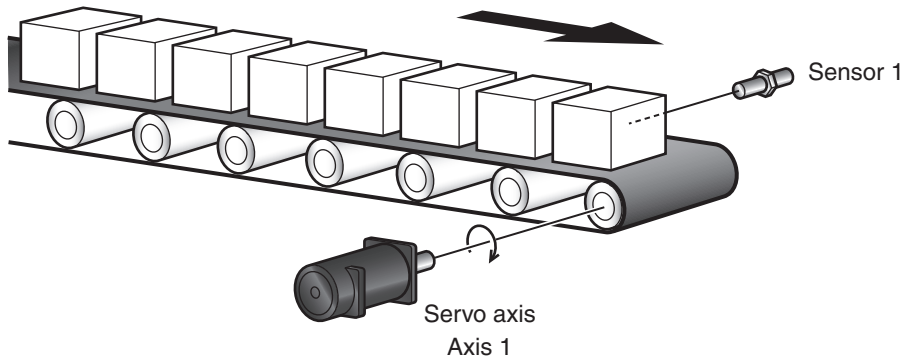

### ● Operation Pattern

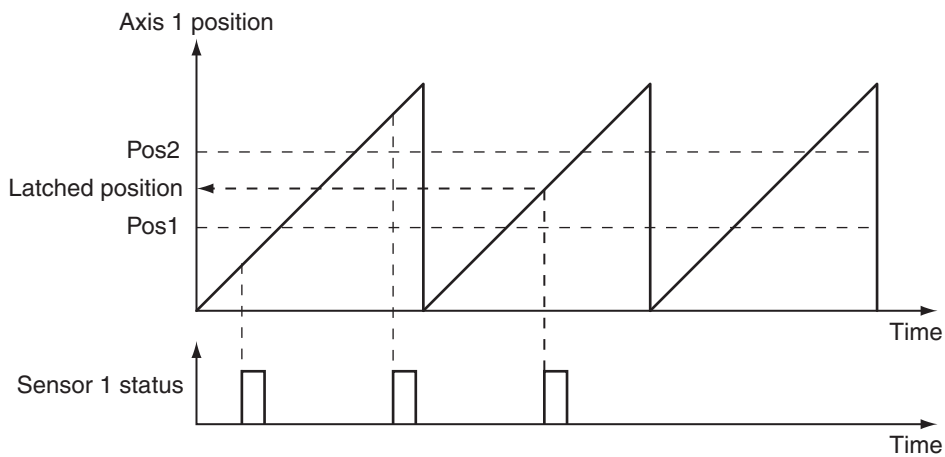

- 1** Starting the Master Axis  
Velocity control is performed for axis 1.
- 2** Detecting Workpiece  
Sensor 1 detects the workpiece.
- 3** Latching the Position  
If the workpiece is detected in the window (Pos1 to Pos2), the position of axis 1 is latched.

## Ladder Diagram

### ● Main Variables

Name	Data type	Default	Comment
MC_Axis000	_sAXIS_REF	---	This is the Axis Variable for axis 1.
MC_Axis000.MFaultLvl.Active	BOOL	FALSE	TRUE while there is a minor fault level error for axis 1.
MC_Axis000.Details.Homed	BOOL	FALSE	TRUE when home is defined for axis 1.

Name	Data type	Default	Comment
Pwr_Status	BOOL	FALSE	This variable is assigned to the <i>Status</i> output variable from the PWR instance of the MC_Power instruction. This variable changes to TRUE when the Servo is turned ON.
Pos1	LREAL	---	This variable specifies the first position of the window.
Pos2	LREAL	---	This variable specifies the last position of the window.
StartPg	BOOL	FALSE	The Servo is turned ON if this variable is TRUE and EtherCAT process data communications are established.
InitFlag	BOOL	FALSE	This variable indicates if it is necessary to set the input parameters. Input parameters are set when this variable is FALSE. When setting the input parameters is completed, this variable changes to TRUE.

● Sample Programming

If *StartPg* is TRUE, check that the Servo Drive is ready.

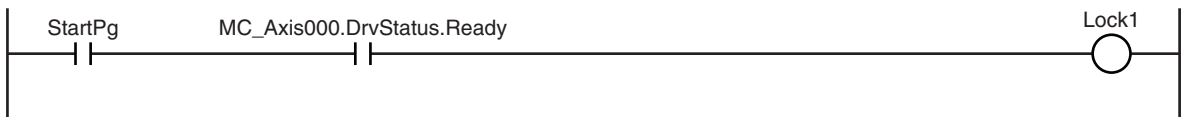

If the Servo Drive for axis 1 is ready, the Servo is turned ON.

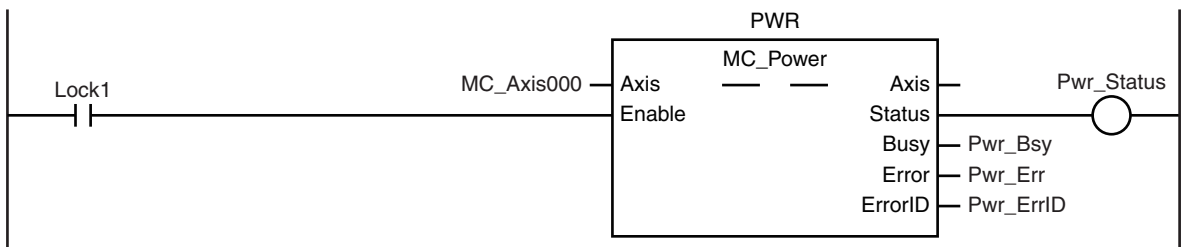

If a minor fault level error occurs for axis 1, the error handler for the device (FaultHandler) is executed. Program the FaultHandler according to the device.

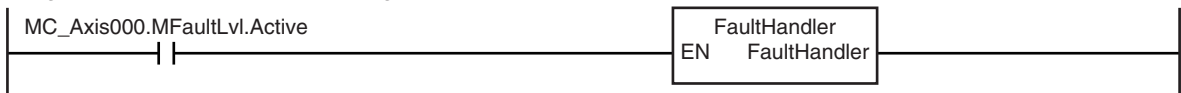

If the Servo is ON and home is not defined, the Home instruction is executed.

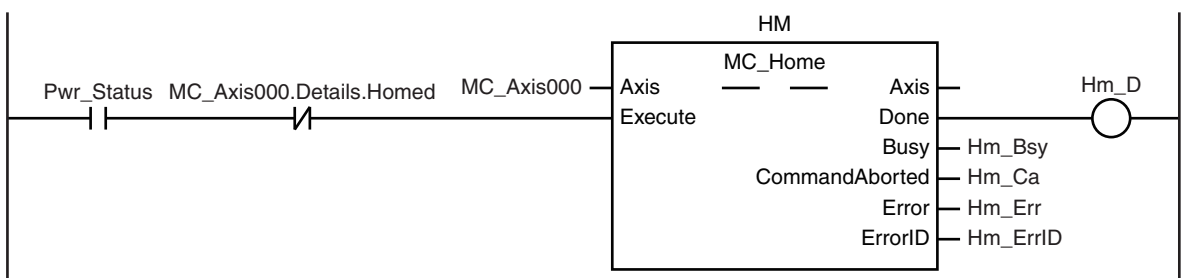

The parameters are set for the MC\_MoveVelocity (Velocity Control) and MC\_TouchProbe (Enable External Latch) instructions.

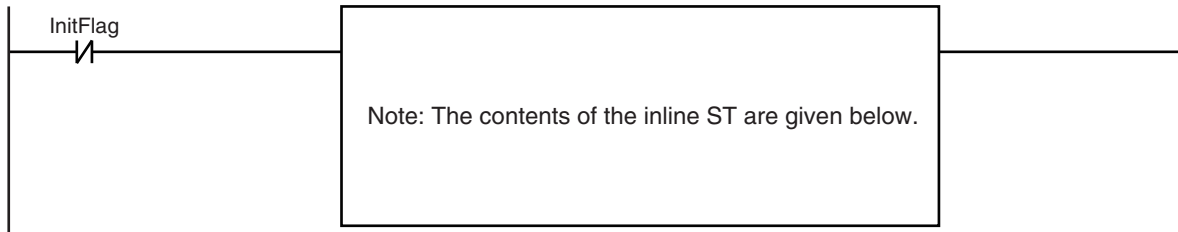

The MC\_MoveVelocity (Velocity Control) instruction is executed if home is defined for axis 1.

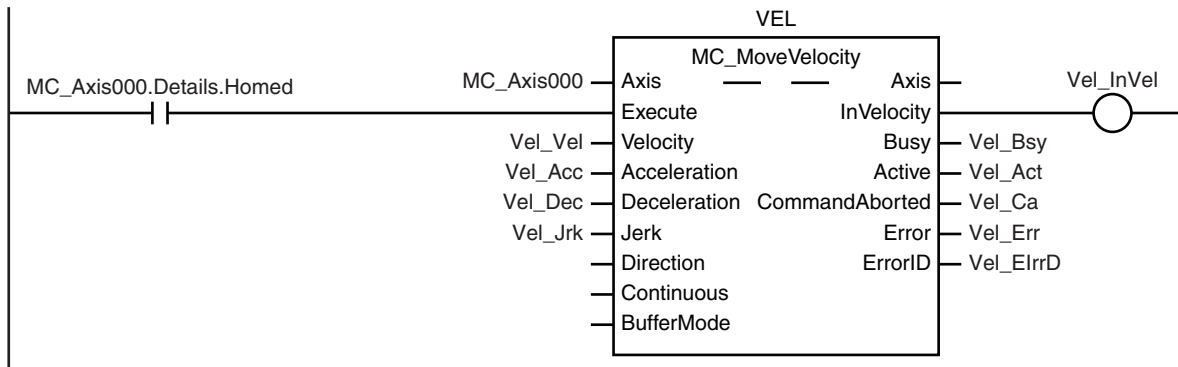

Latch processing is executed after the MC\_MoveVelocity (Velocity Control) instruction is started.

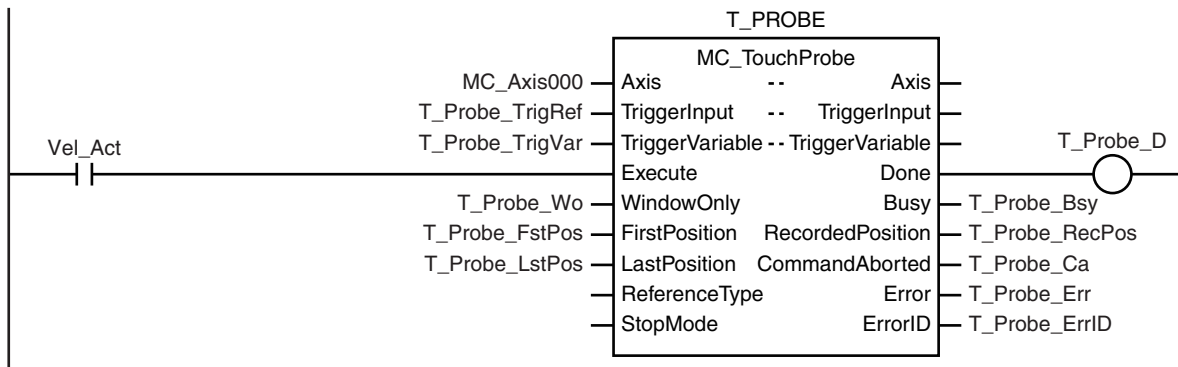

#### Contents of Inline ST

```
// MC_MoveVelocity parameters
Vel_Vel := LREAL#1000.0;
Vel_Acc := LREAL#1000.0;
Vel_Dec := LREAL#1000.0;
Vel_Jrk := LREAL#1000.0;

// MC_TouchProbe parameters
T_Probe_TrigRef.Mode := _eMC_TRIGGER_MODE#_mcDrive;
T_Probe_TrigRef.LatchID := _eMC_TRIGGER_LATCH_ID#_mcLatch1;
T_Probe_TrigRef.InputDrive := _eMC_TRIGGER_INPUT_DRIVE#_mcEXT;
T_Probe_TrigVar := FALSE;
T_Probe_Wo := TRUE;
T_Probe_FstPos := LREAL#1000.0;
T_Probe_LstPos := LREAL#2000.0;
```

```
// Change InitFlag to TRUE after setting the input parameters.
InitFlag:=TRUE;
```

## Structured Text (ST)

### ● Main Variables

Name	Data type	Default	Comment
MC_Axis000	_sAXIS_REF	---	This is the Axis Variable for axis 1.
MC_Axis000.MFaultLvl.Active	BOOL	FALSE	TRUE while there is a minor fault level error for axis 1.
MC_Axis000.Details.Homed	BOOL	FALSE	TRUE when home is defined for axis 1.
Pwr_Status	BOOL	FALSE	This variable is assigned to the <i>Status</i> output variable from the PWR instance of the MC_Power instruction. This variable changes to TRUE when the Servo is turned ON.
Pos1	LREAL	---	This variable specifies the first position of the window.
Pos2	LREAL	---	This variable specifies the last position of the window.
StartPg	BOOL	FALSE	The Servo is turned ON if this variable is TRUE and EtherCAT process data communications are established.
InitFlag	BOOL	FALSE	This variable indicates if it is necessary to set the input parameters. Input parameters are set when this variable is FALSE. When setting the input parameters is completed, this variable changes to TRUE.

### ● Sample Programming

```
// Processing when input parameters are not set
IF InitFlag=FALSE THEN

    // MC_MoveVelocity parameters
    Vel_Vel := LREAL#1000.0;
    Vel_Acc := LREAL#1000.0;
    Vel_Dec := LREAL#1000.0;
    Vel_Jrk := LREAL#1000.0;

    // MC_TouchProbe parameters
    T_Probe_TrigRef.Mode := _eMC_TRIGGER_MODE#_mcDrive;
    T_Probe_TrigRef.LatchID := _eMC_TRIGGER_LATCH_ID#_mcLatch1;
    T_Probe_TrigRef.InputDrive := _eMC_TRIGGER_INPUT_DRIVE#_mcEXT;
    T_Probe_TrigVar := FALSE;
    T_Probe_Wo := TRUE;
    T_Probe_FstPos := LREAL#1000.0;
    T_Probe_LstPos := LREAL#2000.0;
```

```

        // Change InitFlag to TRUE after setting the input parameters.
        InitFlag:=TRUE;

END_IF;

// If StartPg is TRUE and the Servo Drive is ready, the Servo is turned ON.
// If the Servo Drive is not ready, the Servo is turned OFF.
IF (StartPg=TRUE)
    AND (MC_Axis000.DrvStatus.Ready=TRUE) THEN
        Pwr_En:=TRUE;
ELSE
        Pwr_En:=FALSE;
END_IF;

// Processing for a minor fault level error
// Program the FaultHandler according to the device.
IF MC_Axis000.MFaultLvl.Active=TRUE THEN
        FaultHandler();
END_IF;

// If the Servo is ON and home is not defined, the Home instruction is executed.
IF (Pwr_Status=TRUE) AND (MC_Axis000.Details.Homed=FALSE) THEN
        Hm_Ex:=TRUE;
END_IF;

// After home is defined, MC_MoveVelocity is executed.
IF MC_Axis000.Details.Homed=TRUE THEN
        Vel_Ex:=TRUE;
END_IF;

// After MC_MoveVelocity is executed, MC_TouchProbe is executed.
IF Vel_Act=TRUE THEN
        T_Probe_Ex:= TRUE;
END_IF;

// MC_Power
PWR(
    Axis := MC_Axis000,
    Enable := Pwr_En,
    Status => Pwr_Status,
    Busy => Pwr_Bsy,
    Error => Pwr_Err,
    ErrorID => Pwr_ErrID
);

// MC_Home

```



```

HM(
    Axis := MC_Axis000,
    Execute := Hm_Ex,
    Done => Hm_D,
    Busy => Hm_Bsy,
    CommandAborted => Hm_Ca,
    Error => Hm_Err,
    ErrorID => Hm_ErrID
);

// MC_MoveVelocity
VEL(
    Axis := MC_Axis000,
    Execute := Vel_Ex,
    Velocity := Vel_Vel,
    Acceleration := Vel_Acc,
    Deceleration := Vel_Dec,
    Jerk := Vel_Jrk,
    InVelocity => Vel_InVel,
    Busy => Vel_Bsy,
    Active => Vel_Act,
    CommandAborted => Vel_Ca,
    Error => Vel_Err,
    ErrorID => Vel_ErrID
);

// MC_TouchProbe
T_PROBE(
    Axis := MC_Axis000,
    TriggerInput := T_Probe_TrigRef,
    TriggerVariable := T_Probe_TrigVar,
    Execute := T_Probe_Ex,
    WindowOnly := T_Probe_Wo,
    FirstPosition := T_Probe_FstPos,
    LastPosition := T_Probe_LstPos,
    Done => T_Probe_D,
    Busy => T_Probe_Bsy,
    RecordedPosition => T_Probe_RecPos,
    CommandAborted => T_Probe_Ca,
    Error => T_Probe_Err,
    ErrorID => T_Probe_ErrID
);

```

# MC\_AbortTrigger

The MC\_AbortTrigger instruction aborts a current latch operation.

Instruction	Name	FB/ FUN	Graphic expression	ST expression
MC_AbortTrigger	Disable External Latch	FB		<pre>MC_AbortTrigger_instance (   Axis :=parameter,   TriggerInput :=parameter,   Execute :=parameter,   Done =&gt;parameter,   Busy =&gt;parameter,   CommandAborted =&gt;parameter,   Error =&gt;parameter,   ErrorID =&gt;parameter );</pre>

## Variables

### Input Variables

Name	Meaning	Data type	Valid range	Default	Description
Execute	Execute	BOOL	TRUE or FALSE	FALSE	The instruction is executed when the value of this variable changes to TRUE.

### Output Variables

Name	Meaning	Data type	Valid range	Description
Done	Done	BOOL	TRUE or FALSE	TRUE when the instruction is completed.
Busy	Executing	BOOL	TRUE or FALSE	TRUE when the instruction is acknowledged.
CommandAborted	Command Aborted	BOOL	TRUE or FALSE	TRUE when the instruction is aborted.
Error	Error	BOOL	TRUE or FALSE	TRUE while there is an error.
ErrorID	Error Code	WORD	*1	Contains the error code when an error occurs. A value of 16#0000 indicates normal execution.

\*1. The upper four digits of the event code give the error code for ErrorID. Refer to the *NJ/NX-series Troubleshooting Manual (Cat. No. W503)* for the event codes.

### ● Output Variable Update Timing

Name	Timing for changing to TRUE	Timing for changing to FALSE
Done	<ul style="list-style-type: none"> <li>When latching is stopped.</li> <li>When this instruction is executed for a latch that is not in execution and processing ends.</li> </ul>	<ul style="list-style-type: none"> <li>When <i>Execute</i> is TRUE and changes to FALSE.</li> <li>After one period when <i>Execute</i> is FALSE.</li> </ul>

Name	Timing for changing to TRUE	Timing for changing to FALSE
Busy	When <i>Execute</i> changes to TRUE.	<ul style="list-style-type: none"> <li>When <i>Done</i> changes to TRUE.</li> <li>When <i>Error</i> changes to TRUE.</li> <li>When <i>CommandAborted</i> changes to TRUE.</li> </ul>
CommandAborted	<ul style="list-style-type: none"> <li>When this instruction is aborted because another motion control instruction was executed with the Buffer Mode set to <b>Aborting</b>.</li> <li>When this instruction is canceled due to an error.</li> </ul>	<ul style="list-style-type: none"> <li>When <i>Execute</i> is TRUE and changes to FALSE.</li> <li>After one period when <i>Execute</i> is FALSE.</li> </ul>
Error	When there is an error in the execution of or input parameters for the instruction.	When the error is cleared.

## In-Out Variables

Name	Meaning	Data type	Valid range	Description
Axis	Axis	_sAXIS_REF	---	Specify the target axis for latching. *1
TriggerInput	Trigger Input Condition	_sTRIGGER_REF	---	Use this variable to select the trigger condition. *2

\*1. Specify a user defined Axis Variable that was created in the Axis Basic Settings of the Sysmac Studio (default: MC\_Axis\*) or a system-defined axis variable name (\_MC\_AX[\*], \_MC1\_AX[\*], or \_MC2\_AX[\*]).

If you use Sysmac Studio version 1.29 or higher, you can specify the system-defined axis variable name for AT specification of a user defined variable. This will allow you to specify the user defined variable.

If you use Sysmac Studio version 1.28 or lower, do not specify any user-defined variable created in the variable table.

\*2. Create a user-defined variable with a data type of \_sTRIGGER\_REF.

### ● \_sTRIGGER\_REF

Name	Meaning	Data type	Valid range	Function
Mode	Mode	_eMC_TRIGGER_MODE	0: _mcDrive 1: _mcController	Specify the trigger mode. 0: Drive Mode 1: Controller Mode
LatchID	Latch ID Selection	_eMC_TRIGGER_LATCH_ID	0: _mcLatch1 1: _mcLatch2	Specify which of the two latch functions to use in <b>Drive Mode</b> . 0: Latch 1 1: Latch 2
InputDrive	Trigger Input Signal	_eMC_TRIGGER_INPUT_DRIVE	0: _mcEncoderMark 1: _mcEXT	Specify the Servo Drive trigger signal to use in <b>Drive Mode</b> . 0: Z-phase signal 1: External input

## Function

- The MC\_AbortTrigger cancels a latch operation.
- You can specify the latch operation to abort by specifying the *Axis* and *LatchID* for the MC\_AbortTrigger (Disable External Latch) instruction.
- If you execute MC\_AbortTrigger (Disable External Latch) for a trigger for which there is no latch request, MC\_AbortTrigger does nothing and ends normally.  
This is the same when MC\_AbortTrigger (Disable External Latch) is executed for a MC\_TouchProbe (Enable External Latch) instruction for which *Done* is TRUE.



### Precautions for Correct Use

- If the MC\_GroupEnable (Enable Axes Group) instruction was executed for the Axis that is specified for the MC\_AbortTrigger (Disable External Latch) instruction, an error occurs for the MC\_AbortTrigger instruction and it is not executed.
- An error occurs for this instruction if the MC\_AbortTrigger (Disable External Latch) instruction is executed during execution of the MC\_Home, MC\_HomeWithParameter, MC\_MoveFeed (Interrupt Feeding), or MC\_MoveLink (Synchronous Positioning) instruction.

## Timing Chart

- *Done* for the MC\_AbortTrigger (Disable External Latch) instruction changes to TRUE one period after *Execute* changes to TRUE.

### MC\_TouchProbe

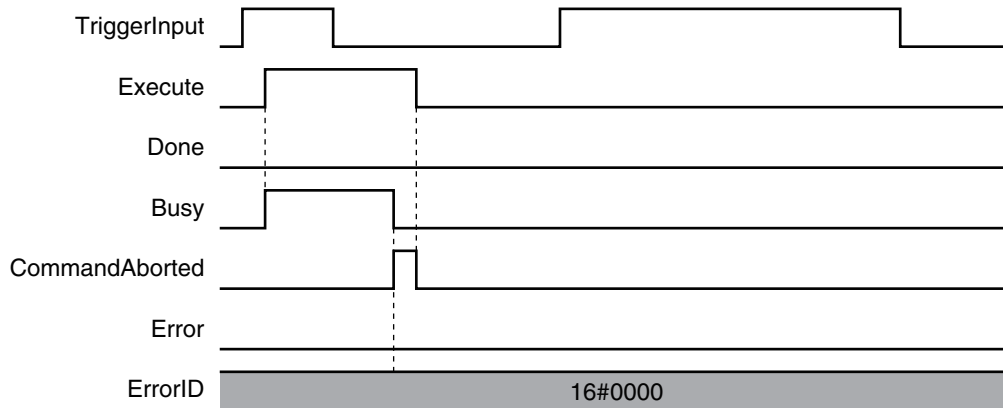

### MC\_AbortTrigger

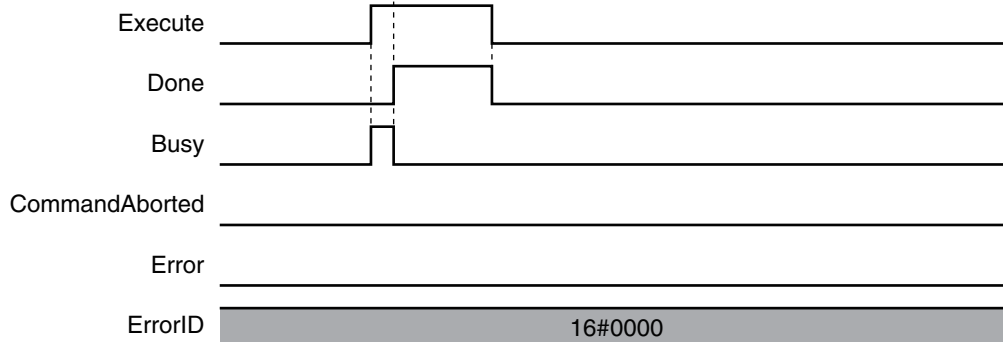

## Re-execution of Motion Control Instructions

This instruction cannot be re-executed.

A Motion Control Instruction Re-execution Disabled error (error code: 543B hex) occurs if re-execution is attempted.

## Multi-execution of Motion Control Instructions

For details on multi-execution of motion control instructions, refer to the *NJ/NX-series CPU Unit Motion Control User's Manual (Cat. No. W507)*.

## Errors

If an error occurs during instruction execution, *Error* will change to TRUE.  
 You can find out the cause of the error by referring to the value output by *ErrorID* (Error Code).

### MC\_AbortTrigger

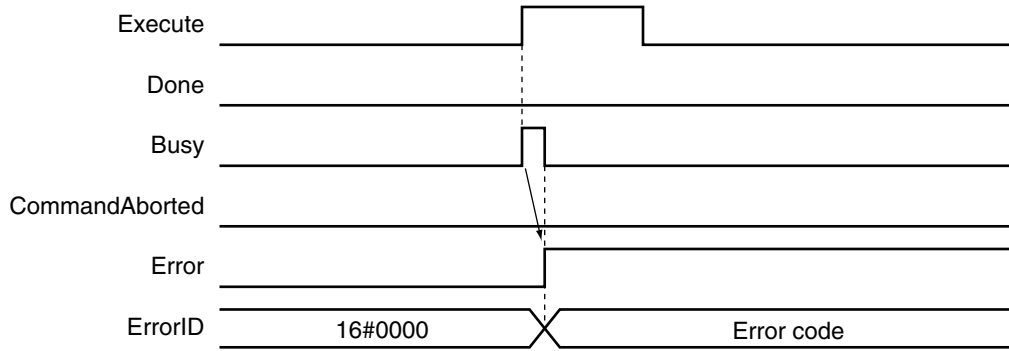

### ● Error Codes

Refer to the *NJ/NX-series Troubleshooting Manual (Cat. No. W503)* for instruction errors.

# MC\_AxesObserve

The MC\_AxesObserve instruction monitors the deviation between the command positions or the actual positions for the specified axes to see if it exceeds the allowed value.

Instruction	Name	FB/ FUN	Graphic expression	ST expression
MC_AxesObserve	Monitor Axis Following Error	FB		<pre>MC_AxesObserve_instance (   Master :=parameter,   Slave :=parameter,   Enable :=parameter,   ReferenceType :=parameter,   PermittedDeviation :=parameter,   Enabled =&gt;parameter,   Invalid =&gt;parameter,   Busy =&gt;parameter,   DeviatedValue =&gt;parameter,   Error =&gt;parameter,   ErrorID =&gt;parameter );</pre>

## Variables

### Input Variables

Name	Meaning	Data type	Valid range	De- fault	Description
Enable	Enable	BOOL	TRUE or FALSE	FALS E	The instruction is executed when the value of this variable is TRUE.
ReferenceType	Position Type Selection	_eMC_RERER- ENCE_TYPE	0: _mcCommand 1: _mcFeedback	0*1	Specify the position type. 0: Command position (value calculated in the previous task period* <sup>2</sup> ) 1: Actual position (value obtained in the same task period* <sup>2</sup> )
PermittedDeviation	Permitted Following Error	LREAL	Non-negative number	0	Specify the permitted maximum value of the following error between the master and slave axes. The unit is command units. * <sup>3</sup>

\*1. The default value for an enumeration variable is actually not the number, but the enumerator.

\*2. The task period is the primary period if the task is the primary periodic task and the task period of the priority-5 periodic task if the task is the priority-5 periodic task.

\*3. Refer to *Unit Conversion Settings* in the *NJ/NX-series CPU Unit Motion Control User's Manual (Cat. No. W507)* for information on command units.

## Output Variables

Name	Meaning	Data type	Valid range	Description
Enabled	Enable	BOOL	TRUE or FALSE	TRUE when the axis is being controlled.
Invalid	Excessive Following Error between Axes	BOOL	TRUE or FALSE	TRUE when the permitted following error between axes is exceeded.
Busy	Executing	BOOL	TRUE or FALSE	TRUE when the instruction is acknowledged.
DeviatedValue	Following Error between Axes	LREAL	Negative number, positive number, or 0	Contains the difference between the specified master and slave axes. The unit is command units. *1
Error	Error	BOOL	TRUE or FALSE	TRUE while there is an error.
ErrorID	Error Code	WORD	*2	Contains the error code when an error occurs. A value of 16#0000 indicates normal execution.

- \*1. Refer to *Unit Conversion Settings* in the *NJ/NX-series CPU Unit Motion Control User's Manual (Cat. No. W507)* for information on command units.
- \*2. The upper four digits of the event code give the error code for ErrorID. Refer to the *NJ/NX-series Troubleshooting Manual (Cat. No. W503)* for the event codes.

### ● Output Variable Update Timing

Name	Timing for changing to TRUE	Timing for changing to FALSE
Enabled	When <i>Enable</i> changes to TRUE.	<ul style="list-style-type: none"> <li>When <i>Error</i> changes to TRUE.</li> <li>When <i>Enable</i> changes to FALSE.</li> </ul>
Invalid	When the permitted following error between axes is exceeded.	<ul style="list-style-type: none"> <li>When <i>Error</i> changes to TRUE.</li> <li>When <i>Enable</i> changes to FALSE.</li> <li>When the permitted following error between axes is not exceeded.</li> </ul>
Busy	When <i>Enable</i> changes to TRUE.	<ul style="list-style-type: none"> <li>When <i>Error</i> changes to TRUE.</li> <li>When <i>Enable</i> changes to FALSE.</li> </ul>
DeviatedValue *1	When <i>Enable</i> is TRUE.	
Error	When there is an error in the execution conditions or input parameters for the instruction.	When the error is cleared.

- \*1. *DeviatedValue* does not return to FALSE when *Enable* changes to FALSE.

## In-Out Variables

Name	Meaning	Data type	Valid range	Description
Master	Master Axis	_sAXIS_REF	---	Specify the master axis. *1
Slave	Slave Axis	_sAXIS_REF	---	Specify the slave axis. *1

- \*1. Specify a user-defined Axis Variable that was created in the Axis Basic Settings of the Sysmac Studio (default: MC\_Axis\*) or a system-defined axis variable name (\_MC\_AX[\*], \_MC1\_AX[\*], or \_MC2\_AX[\*]).

If you use Sysmac Studio version 1.29 or higher, you can specify the system-defined axis variable name for AT specification of a user-defined variable. This will allow you to specify the user-defined variable.

If you use Sysmac Studio version 1.28 or lower, do not specify any user-defined variable created in the variable table.



### Precautions for Correct Use

Assign the master axis and slave axis to the same task. If you specify an axis that is in a different task as the master axis, an Illegal Master Axis Specification error (error code 5462 hex) occurs.



### Additional Information

You can also set axes that belong to groups.

## Function

- If the difference between the command positions or the actual positions of the specified *Master* (Master Axis) and *Slave* (Slave Axis) exceeds the permitted following error, *Invalid* (Excessive Following Error between Axes) changes to TRUE.

*Invalid* (Excessive Following Error between Axes) changes to TRUE when the following conditions are met.

When  $|\text{DeviatedValue (Following Error between Axes)}| > \text{PermittedDeviation (Permitted Following Error)}$

- The operation of the axis is not affected by this instruction.
- Use the state of the *Invalid* (Excessive Following Error between Axes) output variable to program processes, such as stopping an axis.

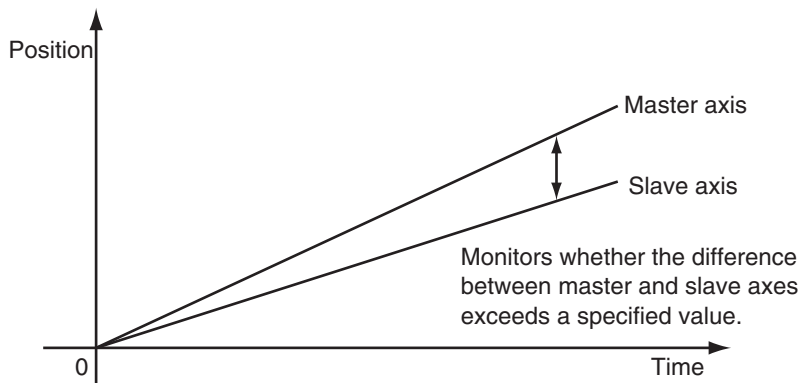





### Precautions for Correct Use

- Use the same Count Mode for the *Master* (Master Axis) and *Slave* (Slave Axis). If a different mode is set, the axes will be compared in **Linear Mode**. Even if both axes are in **Rotary Mode**, comparisons are made in **Linear Mode** if the ranges set for the ring counters are not the same.
- If *PermittedDeviation* (Permitted Following Error) contains a non-terminating decimal number, e.g., resulting from division, error may cause unexpected processing results.
- With an NX-series CPU Unit, assign *Master* (Master Axis) and *Slave* (Slave Axis) to the same task. If you assign them to different tasks, an Illegal Master Axis Specification error (error code 5462 hex) occurs for *Slave* (Slave Axis).
- This function is not effective for monitoring an NX-series Pulse Output Unit because the command position equals the actual current position.

## Instruction Details

This section describes the instruction in detail.

### ● ReferenceType (Position Type Selection)

Any of the following position types can be selected for the master axis to which the slave axis is synchronized.

- `_mcCommand`: Command position (value calculated in the previous task period)  
The master axis command position that was calculated in the previous task period is used for the current period.  
The command value that was calculated for the master axis in the last periodic task is used to calculate the command position of the slave axis in the current period.
- `_mcFeedback`: Value obtained in the same task period  
The actual position of the master axis that was obtained in the same task period is used.



### Precautions for Correct Use

Here, the task period is the primary period if the task is the primary periodic task and the task period of the priority-5 periodic task if the task is the priority-5 periodic task. In the same way, the periodic task is the primary periodic task or the priority-5 periodic task.

### ● Relationship between Axis Types and Position Types

The relationship between the axis types that you can monitor and position types that is monitored is shown below.

Axis Type	ReferenceType	
	<code>_mcCommand</code>	<code>_mcFeedback</code>
Servo axis	OK	OK
Encoder axis	No*1	OK
Virtual servo axis	OK	OK
Virtual encoder axis	No*1	OK

\*1. A Position Type Selection Out of Range error (error code: 5430 hex) occurs when the instruction is executed.

## ● Calculation Examples for *DeviatedValue* (Following Error between Axes)

The *DeviatedValue* (Following Error between Axes) is calculated as described below.

### Linear Mode

#### **ReferenceType (Position Type Selection) Set to `_mcCommand`**

*DeviatedValue* (Following Error between Axes) = Command current position of *Master* (Master Axis) - Command current position of *Slave* (Slave Axis)

#### **ReferenceType (Position Type Selection) Set to `_mcFeedback`**

*DeviatedValue* (Following Error between Axes) = Actual current position of *Master* (Master Axis) - Actual current position of *Slave* (Slave Axis)

### Rotary Mode

#### **ReferenceType (Position Type Selection) Set to `_mcCommand`**

The *DeviatedValue* (Following Error between Axes) is the shorter distance between the command current position of the *Master* (Master Axis) and the command current position of the *Slave* (Slave Axis) in the range of the ring counter.

The sign of the *DeviatedValue* (Following Error between Axes) is the sign for the shorter direction, as given below.

- If the command current position of the *Master* (Master Axis) is greater than or equal to the command current position of the *Slave* (Slave Axis), the value is positive.
- If the command current position of the *Master* (Master Axis) is less than the command current position of the *Slave* (Slave Axis), the value is negative.

#### **ReferenceType (Position Type Selection) Set to `_mcFeedback`**

The *DeviatedValue* (Following Error between Axes) is the shorter distance between the actual current position of the *Master* (Master Axis) and the actual current position of the *Slave* (Slave Axis) in the range of the ring counter.

The sign of the *DeviatedValue* (Following Error between Axes) is the sign for the shorter direction, as given below.

- If the actual current position of the *Master* (Master Axis) is greater than or equal to the actual current position of the *Slave* (Slave Axis), the value is positive.
- If the actual current position of the *Master* (Master Axis) is less than the actual current position of the *Slave* (Slave Axis), the value is negative.

*DeviatedValue* (Following Error between Axes) Calculation Example in **Rotary Mode** when *ReferenceType* (Position Type Selection) Is Set to `_mcCommand`

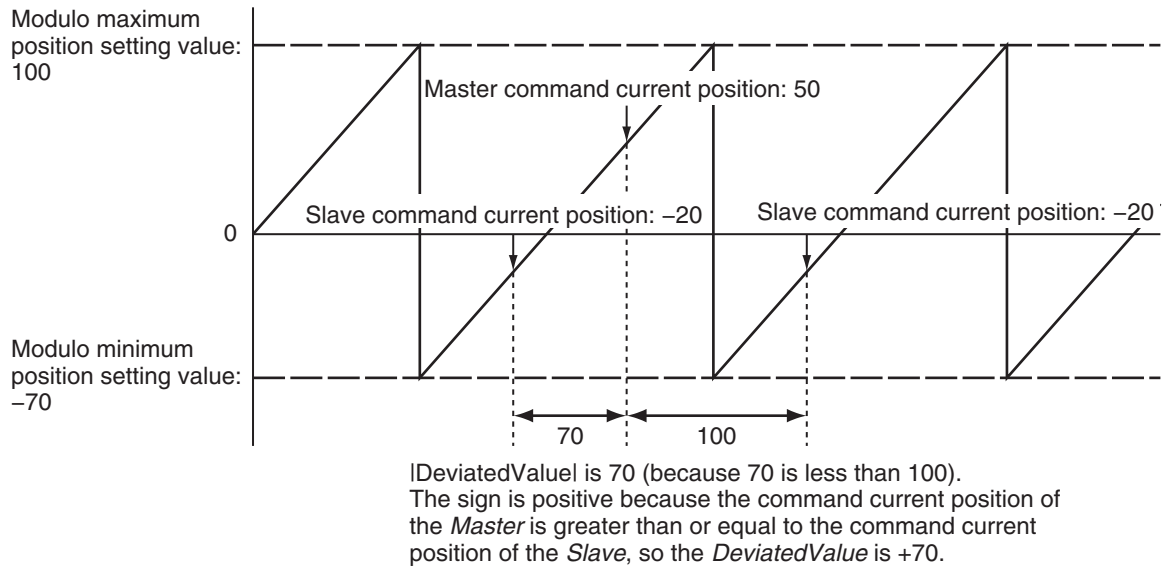

If *ReferenceType* (Position Type Selection) is `_mcFeedback` in **Rotary Mode**, the "command current position" in the above diagram would be the "actual current position".

## Timing Charts

An error for this instruction does not affect the operation of the axis or axes group.

A timing chart is given below for when *PermittedDeviation* (Permitted Following Error) is 10.0.

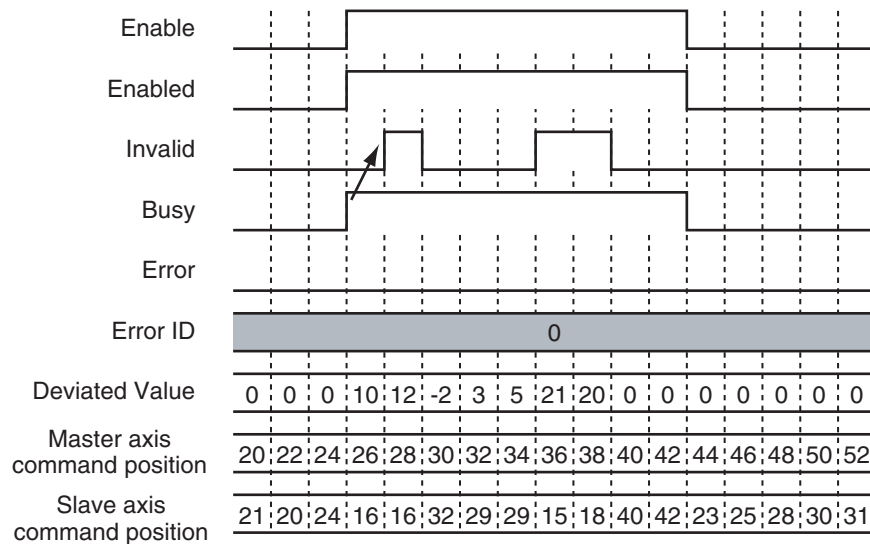

## Re-execution of Motion Control Instructions

You cannot re-execute motion instructions with enable-type inputs.

## Multi-execution of Motion Control Instructions

- There are no restrictions for multi-execution of instructions.

For details on multi-execution of motion control instructions, refer to the *NJ/NX-series CPU Unit Motion Control User's Manual (Cat. No. W507)*.

## Errors

If an error occurs during instruction execution, *Error* will change to TRUE.

You can find out the cause of the error by referring to the value output by *ErrorID* (Error Code).

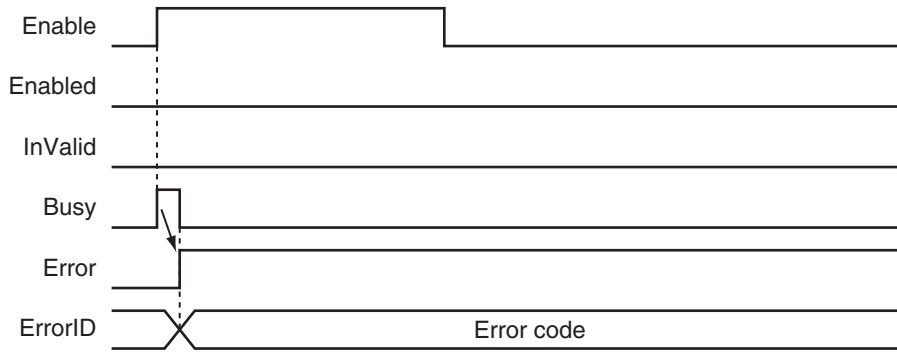

### ● Error Codes

Refer to the *NJ/NX-series Troubleshooting Manual (Cat. No. W503)* for instruction errors.

# MC\_SyncMoveVelocity

The MC\_SyncMoveVelocity instruction outputs the value set for the target velocity every task period to the Servo Drive in Cyclic Synchronous Velocity Mode.

Instruction	Name	FB/ FUN	Graphic expression	ST expression
MC_SyncMoveVelocity	Cyclic Synchronous Velocity Control	FB		<pre>MC_SyncMoveVelocity_instance (   Axis :=parameter,   Execute :=parameter,   Velocity :=parameter,   CmdPosMode :=parameter,   BufferMode :=parameter,   InVelocity =&gt;parameter,   Busy =&gt;parameter,   Active =&gt;parameter,   CommandAborted =&gt;parameter,   Error =&gt;parameter,   ErrorID =&gt;parameter );</pre>



## Precautions for Correct Use

- You cannot use this instruction for an NX-series Pulse Output Unit.
- Here, the task period is the primary period if the task is the primary periodic task and the task period of the priority-5 periodic task if the task is the priority-5 periodic task.

## Variables

### Input Variables

Name	Meaning	Data type	Valid range	Default	Description
Execute	Execute	BOOL	TRUE or FALSE	FALSE	The instruction is executed when the value of this variable changes to TRUE.
Velocity	Target Velocity	LREAL	Negative number, positive number, or 0	0	Set the target velocity. 0: Set the velocity command value to 0. Positive value: Move in the positive direction. Negative value: Move in the negative direction. The unit is command units/s. *1
CmdPosMode	Command Current Position Count Selection	_eMC_CMDPOS_MODE	0: _mcCount	0*2	0: Use the actual current position and update the command current position. Home remains defined.

Name	Meaning	Data type	Valid range	Default	Description
BufferMode	Buffer Mode Selection	_eMC_BUFFER_MODE	0: _mcAborting 1: _mcBuffered	0*2	Specify the behavior when executing more than one motion instruction. 0: Aborting 1: Buffered

- \*1. Refer to *Unit Conversion Settings* in the *NJ/NX-series CPU Unit Motion Control User's Manual (Cat. No. W507)* for information on command units.
- \*2. The default value for an enumeration variable is actually not the number, but the enumerator.

## Output Variables

Name	Meaning	Data type	Valid range	Description
InVelocity	Target Velocity Reached	BOOL	TRUE or FALSE	TRUE when the target velocity is reached.
Busy	Executing	BOOL	TRUE or FALSE	TRUE when the instruction is acknowledged.
Active	Controlling	BOOL	TRUE or FALSE	TRUE when the axis is being controlled.
CommandAborted	Command Aborted	BOOL	TRUE or FALSE	TRUE when the instruction is aborted.
Error	Error	BOOL	TRUE or FALSE	TRUE while there is an error.
ErrorID	Error Code	WORD	*1	Contains the error code when an error occurs. A value of 16#0000 indicates normal execution.

- \*1. The upper four digits of the event code give the error code for ErrorID. Refer to the *NJ/NX-series Troubleshooting Manual (Cat. No. W503)* for the event codes.

### ● Output Variable Update Timing

Name	Timing for changing to TRUE	Timing for changing to FALSE
InVelocity	When the target velocity is reached.	<ul style="list-style-type: none"> <li>When <i>Error</i> changes to TRUE.</li> <li>When <i>CommandAborted</i> changes to TRUE.</li> </ul>
Busy	When <i>Execute</i> changes to TRUE.	<ul style="list-style-type: none"> <li>When <i>Error</i> changes to TRUE.</li> <li>When <i>CommandAborted</i> changes to TRUE.</li> </ul>
Active	When the instruction is started.	<ul style="list-style-type: none"> <li>When <i>Error</i> changes to TRUE.</li> <li>When <i>CommandAborted</i> changes to TRUE.</li> </ul>
CommandAborted	<ul style="list-style-type: none"> <li>When this instruction is canceled due to another instruction.</li> <li>When this instruction is canceled due to an error in another instruction.</li> <li>When this instruction is executed while there is an axis error.</li> <li>When you start this instruction during MC_Stop instruction execution.</li> </ul>	<ul style="list-style-type: none"> <li>When <i>Execute</i> is TRUE and changes to FALSE.</li> <li>After one period when <i>Execute</i> is FALSE.</li> </ul>
Error	When there is an error in the execution conditions or input parameters for the instruction.	When the error is cleared.

## In-Out Variables

Name	Meaning	Data type	Valid range	Description
Axis	Axis	_sAXIS_REF	---	Specifies the axis. *1

- \*1. Specify a user-defined Axis Variable that was created in the Axis Basic Settings of the Sysmac Studio (default: MC\_Axis\*) or a system-defined axis variable name (\_MC\_AX[\*], \_MC1\_AX[\*], or \_MC2\_AX[\*]).  
 If you use Sysmac Studio version 1.29 or higher, you can specify the system-defined axis variable name for AT specification of a user-defined variable. This will allow you to specify the user-defined variable.  
 If you use Sysmac Studio version 1.28 or lower, do not specify any user-defined variable created in the variable table.

## Function

- The MC\_SyncMoveVelocity instruction outputs the target velocity from the user program every task period to the Servo Drive in Cyclic Synchronous Velocity (CSV) Control Mode.
- When *Execute* changes to TRUE, the Control Mode of the Servo Drive is changed and a command velocity is output.
- If this instruction is executed in the primary periodic task or a priority-5 periodic task, the target velocity is reached in the next task period.

The following timing charts show an example of the operation for when this instruction is executed in the primary periodic task. The same information applies when it is used in a priority-5 periodic task.

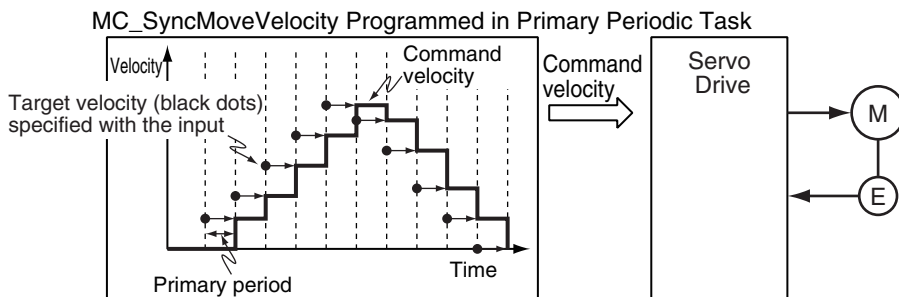

- If this instruction is executed in the priority-16 periodic task, the target velocity is reached in the next task period.

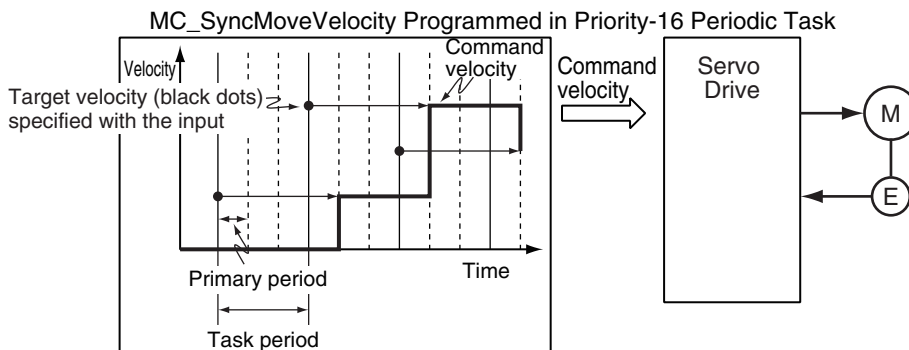

### Precautions for Correct Use

Refer to 1-1-3 *Precautions for Master and Auxiliary Axes in Synchronized Control* on page 1-6 for precautions on using this instruction for the master axis of synchronized control.



### Additional Information

The MC\_SetOverride (Set Override Factors) instruction is not effective for the MC\_SyncMoveVelocity (Cyclic Synchronous Velocity Control) instruction.

## ● Mapping Data Objects

To use the MC\_SyncMoveVelocity (Cyclic Synchronous Velocity Control) instruction, map the following object data in the **Detailed Settings** Area of the Axis Basic Settings Display of the Sysmac Studio.

- Target velocity (60FF hex)
- Modes of operation (6060 hex)
- Modes of operation display (6061 hex)

If even one of the required objects is not set, a Process Data Object Setting Missing error (error code: 3461 hex) occurs.

For details on mapping data objects, refer to *2-3 PDO Mapping* on page 2-39 and to the *NJ/NX-series CPU Unit Motion Control User's Manual (Cat. No. W507)*.

## Instruction Details

This section describes the instruction in detail.

## ● Velocity (Target Velocity)

The *Velocity* (Target Velocity) input variable can be set to LREAL data in reference to 0.

The axis moves in the positive direction for a positive value and in the negative direction for a negative value.

If 0 is set, the command velocity is 0 and *Status.Continuous* (Continuous Motion) remains TRUE.

You can set *Velocity* (Target Velocity) from the user program every period.

If the specified target velocity is different from the last period, the new target velocity is used. If the specified target velocity is the same as the last period, the previous target velocity is used.



### Precautions for Correct Use

- When you set the target velocity, make sure that an excessive load is not placed on the mechanical composition of the system for the change in velocity.
- If the axis that you use in this instruction is the master axis for synchronized control, setting the target velocity of the master axis may cause the slave axis to move suddenly.
- When the Control Mode is changed, the command current position may change suddenly.

## ● Command Current Position

If you select *\_mcCount* for the *CmdPosMode* (Command Current Position Count Selection) input variable, the command current position will be the actual current position from the previous period when this instruction is executed. The actual current position is used until the instruction is ended.

While the OMRON 1S-series Servo Drive or G5-series Servo Drive is processing the switch to CSP Mode, the CSP reference position that was mapped in advance is sent in the PDO. Until processing to switch from CSV to CSP Mode is completed, this reference position is used as the command current position. When switching to CSP Mode is completed, the command current position is set to the command position.



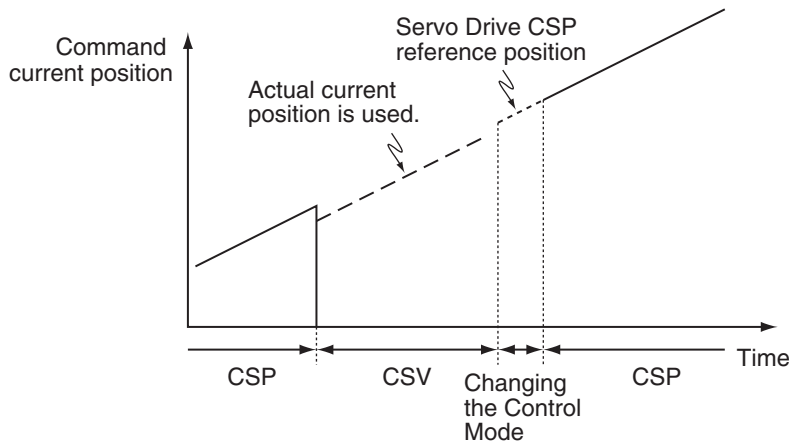

### ● When Using an OMRON 1S-series Servo Drive

To use the CSP reference position of the Servo Drive when changing the Control Mode, map the CSP Reference Position (3010-87 hex) to process data.

Map the CSP Reference Position (3010-87 hex) to process data in the PDO Edit Tab Page of the Sysmac Studio. Then map the CSP Change Reference Position in the MC Function Module and the CSP Reference Position (3010-87 hex) in the **Detailed Settings** Area of the Axis Basic Settings Display.

### ● When Using an OMRON G5-series Servo Drive

To use the CSP reference position of the Servo Drive when changing the Control Mode, map the CSP Reference Position (4020 hex) to process data.

Map the CSP Reference Position (4020 hex) to process data in the PDO Edit Tab Page of the Sysmac Studio. Then map the CSP Change Reference Position in the MC Function Model and the CSP Reference Position (4020 hex) in the **Detailed Settings** Area of the Axis Basic Settings Display.



#### Precautions for Correct Use

If the CSP Reference Position (4020 hex) is mapped to a PDO, set the primary period or the task period of the priority-5 periodic task to 1 ms or longer.

If the primary period or task period is less than 1 ms, an error will occur in the G5-series Servo Drive.

Refer to the *AC Servomotors/Servo Drives G5-series with Built-in EtherCAT Communications User's Manual (Cat. No. I576)* for details.



#### Additional Information

Of the OMRON G5-series Servo Drives, those for Linear Motors do not support the CSP Reference Position (4020 hex).

### ● When Using a Servo Drive Other Than an OMRON 1S-series Servo Drive or G5-series Servo Drive

An error may occur in processing to switch the Control Mode for some Servo Drives when this instruction is executed or when an instruction that uses CSP Mode is executed during execution of this instruction.

If that occurs, stop the axis (velocity of 0) and then execute this instruction or use multi-execution of instructions that use the CSP Mode.

## ● When Using NX-series Position Interface Units

You cannot use this instruction for NX-series Position Interface Units.

## ● Stop Processing

The Control Mode and command velocities that are used to stop axis motion are described below. For a deceleration stop, the target velocity of this instruction is used as the initial velocity and the axis is decelerated to a stop with the deceleration rate for the specified Stop Mode.

### Stopping with the MC\_ImmediateStop Instruction

The command velocity is changed to 0. The Control Mode is changed to CSP Mode when the change criterion that is given below is satisfied.

### Stopping with the MC\_Stop Instruction

The command velocity is changed to 0 at the deceleration rate of the instruction. The Control Mode is changed to CSP Mode when the change criterion that is given below is satisfied.

### Stopping for a Minor Fault Level Error

The command velocity is changed to 0 at the deceleration rate of each error. The Control Mode is changed to CSP Mode when the change criterion that is given below is satisfied.

### Stopping for a Major Fault Level Error or a Partial Fault Level Error

The command velocity is changed to 0. The Control Mode is changed to CSP Mode when the change criterion that is given below is satisfied.

However, depending on the error level, it may not be possible to switch the Control Mode normally, and the axis may stop in CSV Mode.

### Stopping by Turning OFF the Servo

The command velocity is changed to 0 with the specified method. The Control Mode is not changed.

### Stopping When the Operating Mode of the CPU Unit Changes to PROGRAM Mode

The command velocity is changed to 0 with the specified method. The Control Mode is changed to CSP Mode when the change criterion that is given below is satisfied.

## ● Change Criterion

Whether it is possible to change the Control Mode depends on Servo Drive specifications.

To ensure that the Control Mode is switched to CSP Mode during stop processing for stop instructions or errors, it is necessary to sufficiently decelerate the Servomotor first.

The Control Mode is changed to CSP Mode when the following criterion is met for three consecutive periodic tasks after the command velocity changes to 0.

$$\text{Actual current velocity} \leq \text{Maximum velocity} \times 0.1$$



### Precautions for Correct Use

---

Here, the periodic task is the primary periodic task or the priority-5 periodic task.

---

## ● Recovery to Cyclic Synchronous Position (CSP) Control Mode

It is not always possible to normally change to CSP Mode for a stop.

For example, it may not be possible when a partial fault level error occurs in the MC Function Module.

Therefore, processing to change to CSP Mode is performed when the *Status* output variable from the MC\_Power (Power Servo) instruction changes to FALSE.

### ● Operation for Failure to Switch Control Mode

If the Servo Drive does not complete switching the Control Mode within 1 second after a Control Mode switch command is sent to the Servo Drive, an Error in Changing Servo Drive Control Mode (error code: 7439 hex) occurs.

Also, if the switching criterion is not met within 10 seconds after the command velocity is changed to 0 for a Control Mode switching command to the Servo Drive, an Error in Changing Servo Drive Control Mode (error code: 7439 hex) occurs.

When an Error in Changing Servo Drive Control Mode (error code: 7439 hex) occurs, the command velocity is changed to 0 and the Servo is turned OFF (free-run stop).

For details on the Error in Changing Servo Drive Control Mode (error code: 7439 hex), refer to the *NJ/NX-series CPU Unit Motion Control User's Manual (Cat. No. W507)*.

### ● Applicable Axes and Execution Condition

- You can use this instruction for a servo axis.  
To use this instruction, change *Enable* for the MC\_Power instruction to TRUE (Servo ON).
- A virtual servo axis will acknowledge this instruction at any time.  
However, processing to switch the Control Mode of the Servo Drive is not performed.
- An error occurs if the instruction is executed for an encoder or virtual encoder axis.

### ● Axis Variable Status

*Status.Continuous* (Continuous Motion) in the Axis Variable status changes to TRUE.

Use *DrvStatus* (Servo Drive Status) in the Axis Variable to check the Control Mode that is set in the Servo Drive. The Servo Drive status is given in the following table.

Name	Data type	Meaning	Description
CSP	BOOL	Cyclic Synchronous Position (CSP) Control Mode	TRUE when the Servo is ON and the Servo Drive is in CSP Mode.
CSV	BOOL	Cyclic Synchronous Velocity (CSV) Control Mode	TRUE when the Servo is ON and the Servo Drive is in CSV Mode.
CST	BOOL	Cyclic Synchronous Torque (CST) Control Mode	TRUE when the Servo is ON and the Servo Drive is in CST Mode.

### ● Home Status

If *CmdPosMode* (Command Current Position Count Selection) is set to `_mcCount`, the home will remain defined.

### ● Overrides

Overrides are disabled for this instruction.

### ● Software Limits

Software Limits are enabled for this instruction.

They are enabled even for the following axis parameter settings.

- Enabled for command position. Deceleration stop.
- Enabled for command position. Stop using remaining pulses.

## Timing Charts

- *Busy* (Executing) changes to TRUE at the same time as *Execute* changes to TRUE. *Active* (Controlling) changes to TRUE in the next period.
- *InVelocity* (Target Velocity Reached) changes to TRUE when the command velocity reaches *Velocity* (Target Velocity).
- If another instruction aborts this instruction, *CommandAborted* changes to TRUE and *Busy* (Executing), *Active* (Controlling), and *InVelocity* (Target Velocity Reached) change to FALSE.
- The MC\_Stop instruction is used to stop this instruction.

The following timing charts show operation for when this instruction is used in the primary periodic task.

MC\_SyncMoveVelocity Instruction

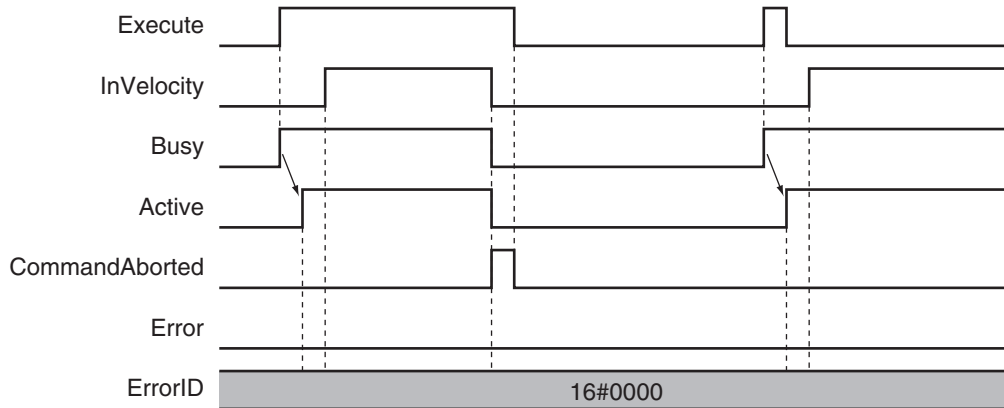

MC\_Stop Instruction

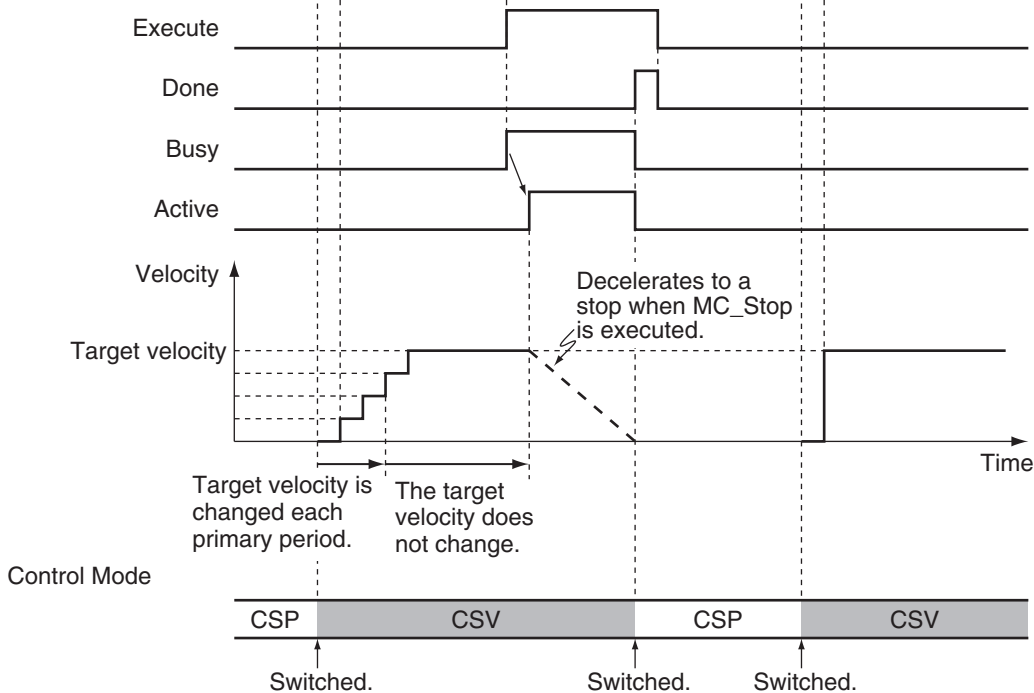



### Additional Information

The MC Function Module sends a command to the Servo Drive to change the Control Mode as shown in the above timing chart. The timing of implementing the change in the Servo Drive depends on Servo Drive specifications.

## Re-execution of Motion Control Instructions

This instruction cannot be re-executed.

A Motion Control Instruction Re-execution Disabled error (error code: 543B hex) occurs if re-execution is attempted.

## Multi-execution of Motion Control Instructions

For details on multi-execution of motion control instructions, refer to the *NJ/NX-series CPU Unit Motion Control User's Manual (Cat. No. W507)*.

### ● Execution during Execution of Other Instructions

You can execute this instruction with *BufferMode* (Buffer Mode Selection) set to **Aborting** or **Buffered** during execution of other instructions in the same as for the MC\_MoveVelocity (Velocity Control) instruction.

The Control Mode is switched when processing the instruction is started.

For details on *BufferMode* (Buffer Mode Selection), refer to the *NJ/NX-series CPU Unit Motion Control User's Manual (Cat. No. W507)*.

### ● Execution of Other Instructions during Instruction Execution

You can execute other instructions with *BufferMode* (Buffer Mode Selection) set to **Aborting** or **Buffered** during execution of this instruction in the same as for the MC\_MoveVelocity (Velocity Control) instruction.

If the other instruction is **Buffered**, then it is executed when *InVelocity* (Target Velocity Reached) changes to TRUE.

The Control Mode is switched when processing the instruction is started.

## Errors

If an error occurs during instruction execution, *Error* will change to TRUE.

You can find out the cause of the error by referring to the value output by *ErrorID* (Error Code).

● **Timing Chart When Error Occurs**

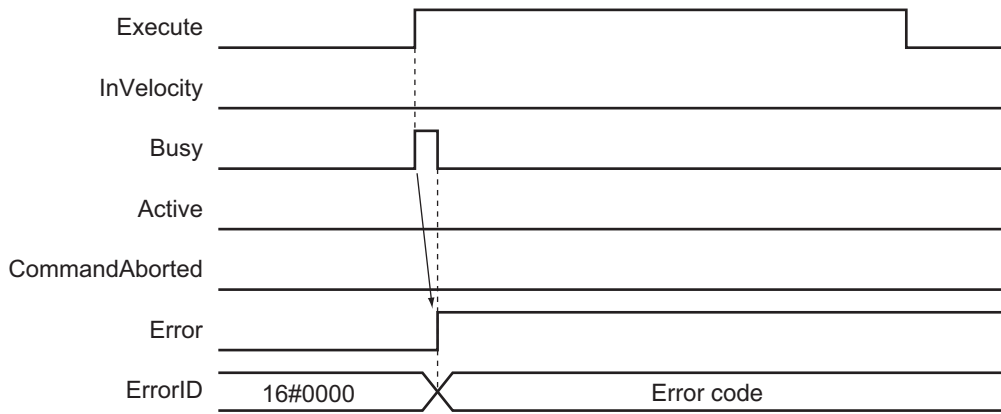

● **Error Codes**

Refer to the *NJ/NX-series Troubleshooting Manual (Cat. No. W503)* for instruction errors.

# MC\_SyncMoveAbsolute

The MC\_SyncMoveAbsolute instruction cyclically outputs the specified target position for the axis.

Instruction	Name	FB/ FU N	Graphic expression	ST expression
MC_SyncMoveAbsolute	Cyclic Synchronous Absolute Positioning	FB		<pre>MC_SyncMoveAbsolute_instance (   Axis :=parameter,   Execute :=parameter,   Position :=parameter,   Direction :=parameter,   BufferMode :=parameter,   InPosition =&gt;parameter,   Busy =&gt;parameter,   Active =&gt;parameter,   CommandAborted =&gt;parameter,   Error =&gt;parameter,   ErrorID =&gt;parameter );</pre>



## Version Information

A CPU Unit with unit version 1.03 or later and Sysmac Studio version 1.04 or higher are required to use this instruction.

## Variables

### Input Variables

Name	Meaning	Data type	Valid range	Default	Description
Execute	Execute	BOOL	TRUE or FALSE	FALSE	The instruction is executed when the value of this variable changes to TRUE.
Position	Target Position	LREAL	Negative number, positive number, or 0	0	Specify the absolute target position. The unit is command units. *1
Direction	Direction	_eMC_DIRECTION	0: _mcPositiveDirection 1: _mcShortestWay 2: _mcNegativeDirection 3: _mcCurrentDirection 4: _mcNoDirection	1*2	Specify the direction of rotation when the Count Mode is <b>Rotary Mode</b> . *3 0: Positive direction 1: Shortest way 2: Negative direction 3: Current direction 4: No direction specified

Name	Meaning	Data type	Valid range	De- fault	Description
BufferMode	Buffer Mode Selection	_eMC_BUFFER_MODE	0: _mcAborting	0*2	Specify the behavior when executing more than one motion instruction. 0: Aborting

- \*1. Refer to *Unit Conversion Settings* in the *NJ/NX-series CPU Unit Motion Control User's Manual (Cat. No. W507)* for information on command units.
- \*2. The default value for an enumeration variable is actually not the number, but the enumerator.
- \*3. Refer to *Direction* on page 3-55 for the MC\_MoveAbsolute instruction for how to specify the direction of rotation.

## Output Variables

Name	Meaning	Data type	Valid range	Description
InPosition	In Position	BOOL	TRUE or FALSE	TRUE when the actual current position is within the in-position range of the target position.
Busy	Executing	BOOL	TRUE or FALSE	TRUE when the instruction is acknowledged.
Active	Controlling	BOOL	TRUE or FALSE	TRUE when control is in progress.
CommandAborted	Instruction Aborted	BOOL	TRUE or FALSE	TRUE when the instruction is aborted.
Error	Error	BOOL	TRUE or FALSE	TRUE while there is an error.
ErrorID	Error Code	WORD	*1	Contains the error code when an error occurs. A value of 16#0000 indicates normal execution.

- \*1. The upper four digits of the event code give the error code for ErrorID. Refer to the *NJ/NX-series Troubleshooting Manual (Cat. No. W503)* for the event codes.

### ● Output Variable Update Timing

Name	Timing for changing to TRUE	Timing for changing to FALSE
InPosition	When the actual current position is within the in-position range of the target position.	<ul style="list-style-type: none"> <li>When an actual current position is outside of the in-position range.</li> <li>When <i>Error</i> changes to TRUE.</li> <li>When <i>CommandAborted</i> changes to TRUE.</li> </ul>
Busy	When <i>Execute</i> changes to TRUE.	<ul style="list-style-type: none"> <li>When <i>Error</i> changes to TRUE.</li> <li>When <i>CommandAborted</i> changes to TRUE.</li> </ul>
Active	When the instruction is started.	<ul style="list-style-type: none"> <li>When <i>Error</i> changes to TRUE.</li> <li>When <i>CommandAborted</i> changes to TRUE.</li> </ul>
CommandAborted	<ul style="list-style-type: none"> <li>When this instruction is aborted because another motion control instruction was executed during execution of this instruction.</li> <li>When this instruction is canceled due to an error in another instruction.</li> <li>When this instruction is executed while there is an axis error.</li> <li>When you start this instruction during MC_Stop instruction execution.</li> </ul>	<ul style="list-style-type: none"> <li>When <i>Execute</i> is TRUE and changes to FALSE.</li> <li>After one period when <i>Execute</i> is FALSE.</li> </ul>



Name	Timing for changing to TRUE	Timing for changing to FALSE
Error	When there is an error in the execution conditions or input parameters for the instruction.	When the error is cleared.

## In-Out Variables

Name	Meaning	Data type	Valid range	Description
Axis	Axis	_sAXIS_REF	---	Specifies the axis. *1

- \*1. Specify a user-defined Axis Variable that was created in the Axis Basic Settings of the Sysmac Studio (default: MC\_Axis\*) or a system-defined axis variable name (\_MC\_AX[\*], \_MC1\_AX[\*], or \_MC2\_AX[\*]).  
If you use Sysmac Studio version 1.29 or higher, you can specify the system-defined axis variable name for AT specification of a user-defined variable. This will allow you to specify the user-defined variable.  
If you use Sysmac Studio version 1.28 or lower, do not specify any user-defined variable created in the variable table.

## Function

- The MC\_SyncMoveAbsolute instruction outputs the target position from the user program every task period to the Servo Drive or other device in Cyclic Synchronous Position (CSP) Control Mode. The target position is given as an absolute position.
- The upper limit of the velocity is the value that is set in the **Maximum Velocity** axis parameter. **Maximum Acceleration** and **Maximum Deceleration** are not used.
- If this instruction is executed in the primary periodic task or priority-5 periodic task, the target position that is specified in the input parameters is output to the Servo Drive in the next task period. The following timing charts show an example of the operation for when this instruction is executed in the primary periodic task. The same information applies when it is used in a priority-5 periodic task.

MC\_SyncMoveAbsolute Executed in Primary Periodic Task

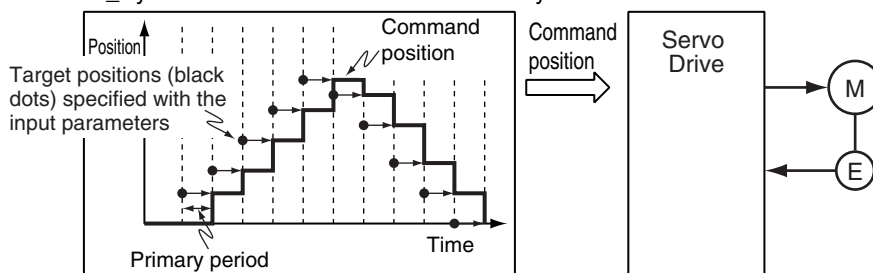

- If this instruction is executed in the priority-16 periodic task, the target position that is specified in the input parameters is output to the Servo Drive in the next periodic task.

MC\_SyncMoveAbsolute Executed in Priority-16 Periodic Task

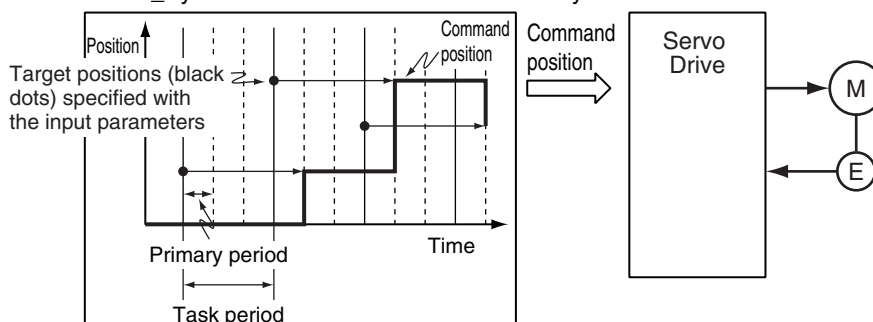



### Precautions for Correct Use

---

Specify the target position so that the travel distance to the target position does not cause the velocity to exceed the value that is specified in the **Maximum Velocity** axis parameter. If a target position is specified that cause the **Maximum Velocity** to be exceeded, the command velocity will become saturated and the travel distance will be output so that the **Maximum Velocity** is not exceeded. If this occurs, any insufficient travel distance to the target position is output in the next period or later.

*Details.VelLimit* (Command Velocity Saturation) in the axis control status changes to TRUE at this time.

---

## Instruction Details

---

This section describes the instruction in detail.

### ● In-position Check

If *Position* (Target Position) is not changed, *InPosition* changes to TRUE when the difference between the target position and the actual position is within the range that is set for the **In-position Range** axis parameter.

Even if the target position is changed while *InPosition* is TRUE, it will remain TRUE for the remainder of the period and change to FALSE the next period.

The setting of the **In-position Check Time** axis parameter is disabled.

### ● Stop Processing

This section describes the methods that are used to stop axis operations.

Use the MC\_Stop or MC\_ImmediateStop instruction to stop operation. If one of these instructions is executed, *CommandAborted* for this instruction will change to TRUE.

#### Stopping with the MC\_Stop Instruction

An immediate stop is performed.

#### Stopping with the MC\_ImmediateStop Instruction

An immediate stop is performed according to the setting of the **Immediate Stop Input Stop Method** axis parameter.

### ● Stopping Due to Errors

If an error that causes the axes to stop occurs, an immediate stop is performed regardless of any settings.

### ● Applicable Axes

- You can use this instruction for a servo axis.  
To use this instruction, change *Enable* for the MC\_Power instruction to TRUE (Servo ON).
- A virtual servo axis will acknowledge this instruction at any time.
- An error occurs if the instruction is executed for an encoder or virtual encoder axis.

### ● Axis Variable Status

*Status.Discrete* (Discrete Motion) in the axis status in the Axis Variable changes to TRUE.  
The Axis Control Status is not affected.

## ● Overrides

Overrides are disabled for this instruction.

## ● Changing the Actual Position

When the actual position is changed with the MC\_SetPosition instruction, the travel distance from the new actual position to the target position that is specified for *Position* (Target Position) is output.

If *InPosition* is TRUE before the actual position is changed, it will change to FALSE the next period after it is changed.

## Timing Charts

- *Busy* (Executing) changes to TRUE at the same time as *Execute* changes to TRUE. *Active* (Controlling) changes to TRUE in the next period.
- *InPosition* changes to TRUE when the actual current position is within the in-position range from *Position* (Target Position).
- If another instruction aborts this instruction, *CommandAborted* changes to TRUE and *Busy* (Executing), *Active* (Controlling), and *InPosition* change to FALSE.
- The MC\_Stop instruction is used to stop this instruction.

The following timing charts show operation for when this instruction is executed in the primary periodic task.

## MC\_SyncMoveAbsolute instruction

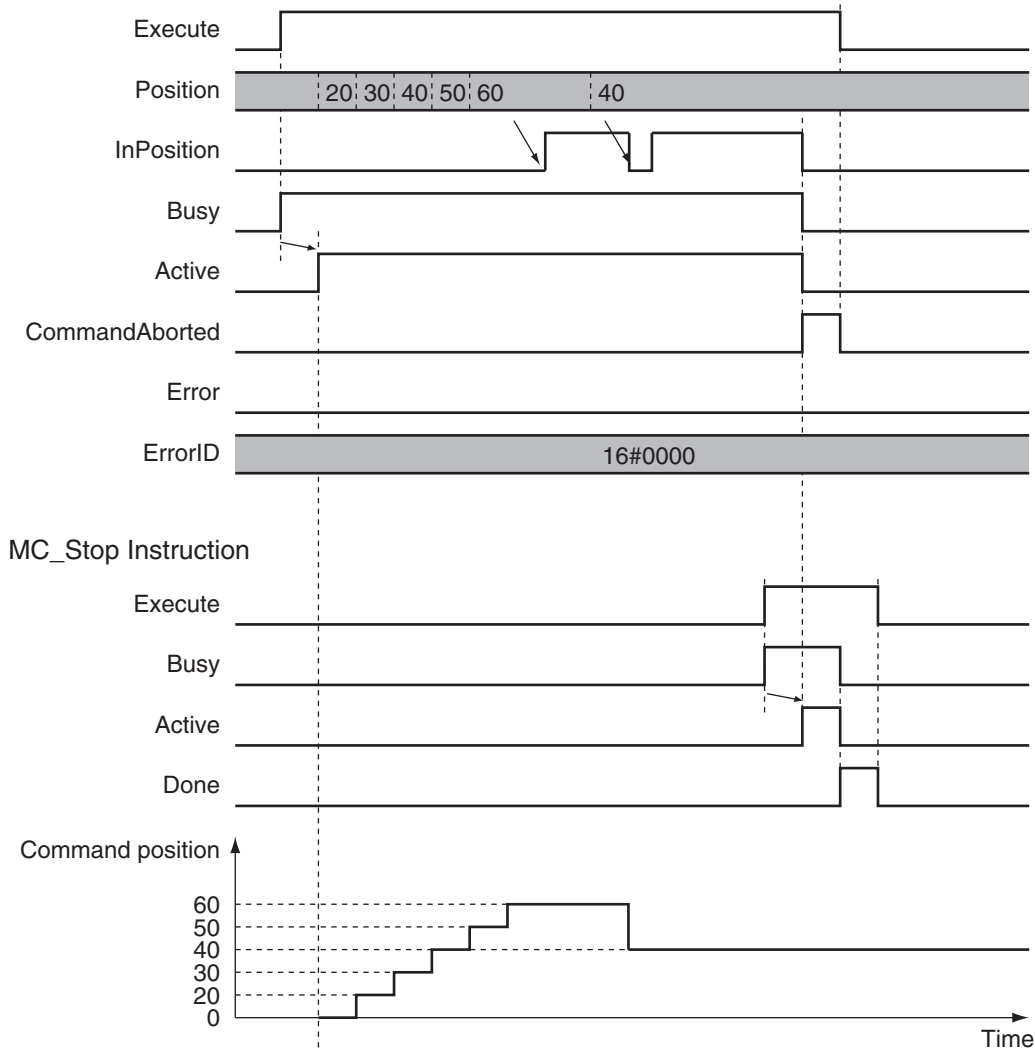

## MC\_Stop Instruction

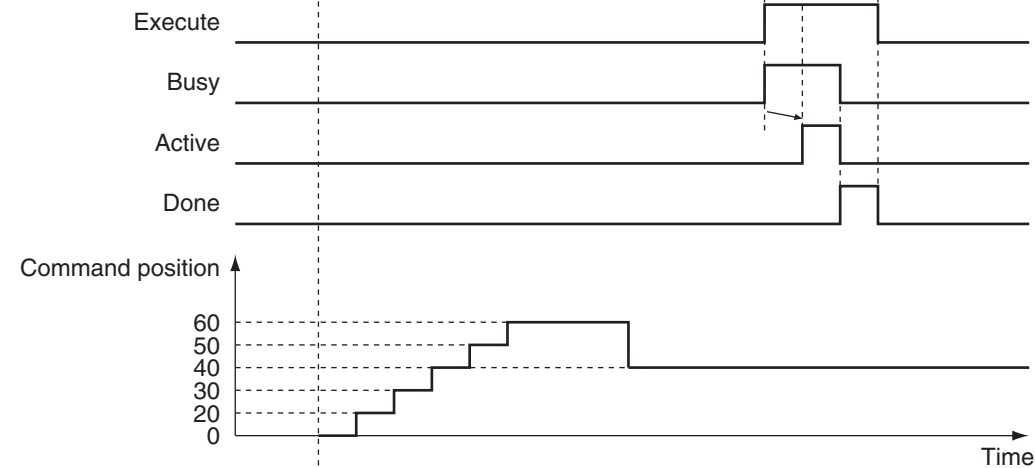
**Additional Information**

The MC Function Module sends a command to the Servo Drive to change the Control Mode as shown in the above timing chart. The timing of implementing the change in the Servo Drive depends on Servo Drive specifications.

## Re-execution of Motion Control Instructions

This instruction cannot be re-executed.

A Motion Control Instruction Re-execution Disabled error (error code: 543B hex) occurs if re-execution is attempted.

## Multi-execution of Motion Control Instructions

For details on multi-execution of motion control instructions, refer to the *NJ/NX-series CPU Unit Motion Control User's Manual (Cat. No. W507)*.

### ● Execution during Execution of Other Instructions

You can switch to this instruction or buffer this instruction if you execute it during execution of another instruction.

You can buffer one instruction per axis.

Specify the operation of this instruction using *BufferMode* (Buffer Mode Selection) for multi-execution of instructions.

Buffer Mode Selection	Description
Aborting	Aborts the instruction being executed and switches to this instruction. If the direction of axis motion is reversed by switching instructions, the motion will be reversed according to the <b>Operation Selection at Reversing</b> axis parameter.

For details on *BufferMode* (Buffer Mode Selection), refer to the *NJ/NX-series CPU Unit Motion Control User's Manual (Cat. No. W507)*.

### ● Execution of Other Instructions during Instruction Execution

If you execute another instruction during execution of this instruction, you can specify only **Aborting**.

## Errors

If an error occurs during instruction execution, *Error* will change to TRUE.

You can find out the cause of the error by referring to the value output by *ErrorID* (Error Code).

### ● Timing Chart When Error Occurs

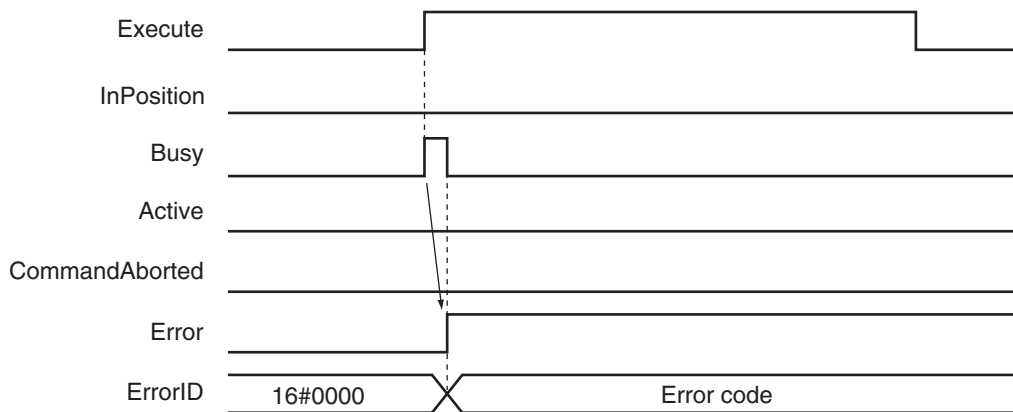

### ● Error Codes

Refer to the *NJ/NX-series Troubleshooting Manual (Cat. No. W503)* for instruction errors.

# MC\_Reset

The MC\_Reset instruction clears axis errors.

Instruction	Name	FB/ FUN	Graphic expression	ST expression
MC_Reset	Reset Axis Error	FB		<pre>MC_Reset_instance (   Axis :=parameter,   Execute =&gt;parameter,   Done =&gt;parameter,   Busy =&gt;parameter,   Failure =&gt;parameter,   Error =&gt;parameter,   ErrorID =&gt;parameter );</pre>

## Variables

### Input Variables

Name	Meaning	Data type	Valid range	Default	Description
Execute	Execute	BOOL	TRUE or FALSE	FALSE	The instruction is executed when the value of this variable changes to TRUE.

### Output Variables

Name	Meaning	Data type	Valid range	Description
Done	Done	BOOL	TRUE or FALSE	TRUE when the instruction is completed.
Busy	Executing	BOOL	TRUE or FALSE	TRUE when the instruction is acknowledged.
Failure	Failure End	BOOL	TRUE or FALSE	TRUE when the instruction is not executed normally.
Error	Error	BOOL	TRUE or FALSE	TRUE while there is an error.
ErrorID	Error Code	WORD	*1	Contains the error code when an error occurs. A value of 16#0000 indicates normal execution.

\*1. The upper four digits of the event code give the error code for ErrorID. Refer to the *NJ/NX-series Troubleshooting Manual (Cat. No. W503)* for the event codes.

### ● Output Variable Update Timing

Name	Timing for changing to TRUE	Timing for changing to FALSE
Done	When error clear processing is completed normally.	<ul style="list-style-type: none"> <li>When <i>Execute</i> is TRUE and changes to FALSE.</li> <li>After one period when <i>Execute</i> is FALSE.</li> </ul>

Name	Timing for changing to TRUE	Timing for changing to FALSE
Busy	When <i>Execute</i> changes to TRUE.	<ul style="list-style-type: none"> <li>When <i>Done</i> changes to TRUE.</li> <li>When <i>Error</i> changes to TRUE.</li> <li>When <i>Failure</i> changes to TRUE.</li> </ul>
Failure	<ul style="list-style-type: none"> <li>When an error reset is executed while decelerating an axis to a stop for an error.</li> <li>When an error reset is executed during an axis error for an axis common error.</li> </ul>	<ul style="list-style-type: none"> <li>When <i>Execute</i> is TRUE and changes to FALSE.</li> <li>After one period when <i>Execute</i> is FALSE.</li> </ul>
Error	When there is an error in the execution conditions or input parameters for the instruction.	When the error is cleared.

## In-Out Variables

Name	Meaning	Data type	Valid range	Description
Axis	Axis	_sAXIS_REF	---	Specifies the axis. *1

- \*1. Specify a user-defined Axis Variable that was created in the Axis Basic Settings of the Sysmac Studio (default: MC\_Axis\*) or a system-defined axis variable name (\_MC\_AX[\*], \_MC1\_AX[\*], or \_MC2\_AX[\*]).  
 If you use Sysmac Studio version 1.29 or higher, you can specify the system-defined axis variable name for AT specification of a user-defined variable. This will allow you to specify the user-defined variable.  
 If you use Sysmac Studio version 1.28 or lower, do not specify any user-defined variable created in the variable table.

## Function

- The MC\_Reset instruction starts error clear processing for the axis specified by *Axis* when *Execute* changes to TRUE.  
 The error processing resets axis errors and, if errors have occurred in the Servo Drive, drive errors. Error clear processing is performed regardless of whether the Servo is ON or OFF for the axes.
- You can use this instruction for any axis type.
- Error clear processing is executed only for axes with errors.
- If there is a drive error for an axis, the drive error is cleared first. Error clear processing is then performed.  
 Reset processing for the drive error is continued until the drive error is cleared or continues for the **Drive Error Reset Monitoring Time** in the axis parameters.
- If this instruction is executed while the axis is decelerating to a stop for an error, the instruction is not executed and *Failure* will change to TRUE. This is to ensure that the error is not reset before the axis stops.  
*Failure* will also change to TRUE if an axis error that results from an MC common error cannot be cleared by this instruction.  
 MC Common errors include MC Common Partial Faults and MC Common Minor Faults.
- Only errors that exist when *Execute* changes to TRUE are cleared. Errors that occur while clearing errors are not cleared.



### Precautions for Correct Use

- The error clear processing that is performed by this instruction sometimes requires more than one control period.
- If an MC Common Partial Fault or MC Common Minor Fault occurs or the axis is in motion, *Failure* (Failure End) from the instruction will change to TRUE. Remove the cause of the error, and then retry the process until *Done* changes to TRUE.
- After you remove the cause of the error, execute the instruction only after you confirm that the axes have stopped completely.  
*Act. Vel* (Actual Current Velocity) in the Axis Variable is 0 if the axis is completely stopped. Use this to confirm when the axis is completely stopped.
- If you use this instruction for an OMRON G5-series Servo Drive, perform exclusive control of instructions so that the *ResetECError* (Reset EtherCAT Error) instruction is not executed at the same time.
- If this instruction is used for an NX-series Pulse Output Unit, the error in the Servo Drive that is connected to the Pulse Output Unit is not reset. Refer to the *NX-series Position Interface Units User's Manual (Cat. No. W524)* for details.



### Additional Information

The following errors cannot be cleared with this instruction.

- All axis common errors: Execute the *ResetMcError* (Reset All Errors) instruction.
- All axes group errors: Execute the *MC\_GroupReset* (Group Reset) instruction.

The causes of network errors, such as slave communications error, are not cleared by executing *MC\_Reset*. Execute the *ResetECError* (Reset EtherCAT Error) instruction.

## Timing Charts

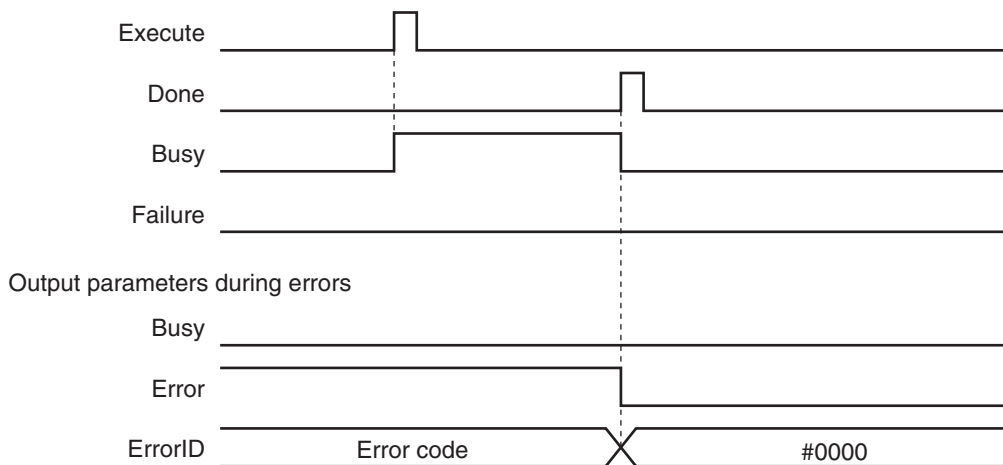

## Aborting the Instruction

The instruction is aborted if it is not possible to clear errors that occur when the axis is decelerating to a stop for an error or errors that occur resulting from axis common errors.



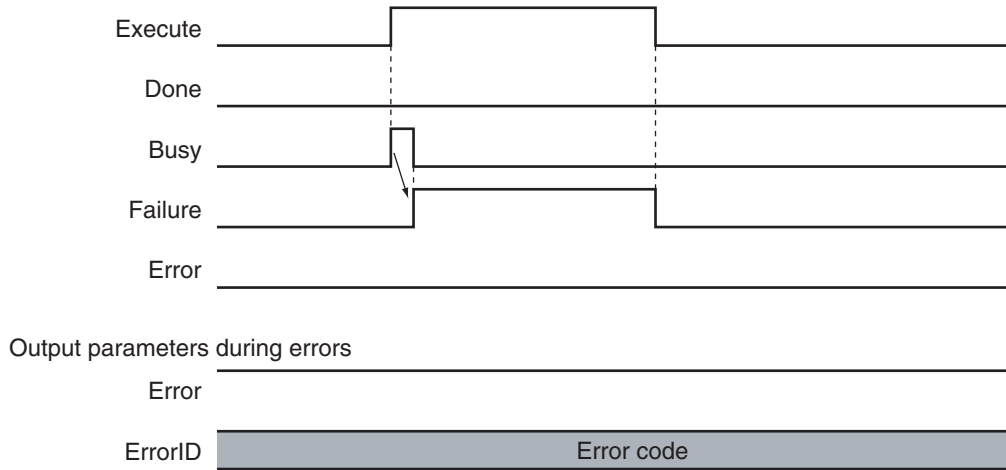

## Error Codes

Refer to the *NJ/NX-series Troubleshooting Manual (Cat. No. W503)* for instruction errors.

# MC\_ChangeAxisUse

The MC\_ChangeAxisUse instruction temporarily changes the **Axis Use** axis parameter.

Instruction	Name	FB/ FUN	Graphic expression	ST expression
MC_ChangeAxisUse	Change Axis Use	FB		<pre>MC_ChangeAxisUse_instance (   Axis :=parameter,   Execute :=parameter,   AxisUse :=parameter,   Done =&gt;parameter,   Busy =&gt;parameter,   CommandAborted =&gt;parameter,   Error =&gt;parameter,   ErrorID =&gt;parameter );</pre>



## Precautions for Correct Use

The values that are written by this instruction are not saved in non-volatile memory in the CPU Unit. Any values that are written are lost when the power supply to the Controller is turned OFF, when settings are downloaded, or when the MC Function Module is restarted. They return to the values that were set from the Sysmac Studio.

Use the Sysmac Studio and transfer the parameters to save them to non-volatile memory.



## Additional Information

- Use the Synchronize Menu of the Sysmac Studio to download the project.
- Refer to the *NJ/NX-series CPU Unit Software User's Manual (Cat. No. W501)* for an application example that uses this instruction.



## Version Information

A CPU Unit with unit version 1.04 or later and Sysmac Studio version 1.05 or higher are required to use this instruction.

## Variables

### Input Variables

Name	Meaning	Data type	Valid range	Default	Description
Execute	Execute	BOOL	TRUE or FALSE	FALSE	The instruction is executed when the value of this variable changes to TRUE.
AxisUse	Axis Use	_eMC_AXIS_USE	1: _mcUnusedAxis 2: _mcUsedAxis	1 *1	Specify a used axis or an unused axis. 1: Unused axis 2: Used axis

\*1. The default value for an enumeration variable is actually not the number, but the enumerator.

## Output Variables

Name	Meaning	Data type	Valid range	Description
Done	Done	BOOL	TRUE or FALSE	TRUE when the instruction is completed.
Busy	Executing	BOOL	TRUE or FALSE	TRUE when the instruction is acknowledged.
CommandAborted	Command Aborted	BOOL	TRUE or FALSE	TRUE when the instruction is aborted.
Error	Error	BOOL	TRUE or FALSE	TRUE while there is an error.
ErrorID	Error Code	WORD	*1	Contains the error code when an error occurs. A value of 16#0000 indicates normal execution.

\*1. The upper four digits of the event code give the error code for ErrorID. Refer to the *NJ/NX-series Troubleshooting Manual (Cat. No. W503)* for the event codes.

### ● Output Variable Update Timing

Name	Timing for changing to TRUE	Timing for changing to FALSE
Done	When the instruction is completed.	<ul style="list-style-type: none"> <li>When <i>Execute</i> is TRUE and changes to FALSE.</li> <li>After one period when <i>Execute</i> is FALSE.</li> </ul>
Busy	When <i>Execute</i> changes to TRUE.	<ul style="list-style-type: none"> <li>When <i>Done</i> changes to TRUE.</li> <li>When <i>Error</i> changes to TRUE.</li> <li>When <i>CommandAborted</i> changes to TRUE.</li> </ul>
CommandAborted	When this instruction is canceled due to an error in another instruction.	<ul style="list-style-type: none"> <li>When <i>Execute</i> is TRUE and changes to FALSE.</li> <li>After one period when <i>Execute</i> is FALSE.</li> </ul>
Error	When there is an error in the execution conditions or input parameters for the instruction.	When the error is cleared.

## In-Out Variables

Name	Meaning	Data type	Valid range	Description
Axis	Axis	_sAXIS_REF	---	Specifies the axis. *1

\*1. Specify a user-defined Axis Variable that was created in the Axis Basic Settings of the Sysmac Studio (default: MC\_Axis\*) or a system-defined axis variable name (\_MC\_AX[\*], \_MC1\_AX[\*], or \_MC2\_AX[\*]).

If you use Sysmac Studio version 1.29 or higher, you can specify the system-defined axis variable name for AT specification of a user-defined variable. This will allow you to specify the user-defined variable.

If you use Sysmac Studio version 1.28 or lower, do not specify any user-defined variable created in the variable table.

## Function

- When *Execute* changes to TRUE, the MC\_ChangeAxisUse instruction temporarily changes the axis status to the setting specified by the *AxisUse* axis parameter.
- When execution of the instruction is completed, \_MC\_AX[\*].Cfg.AxEnable (Axis Use) in the Axis Variable changes to the specified setting.

- You can change the setting only for axes that have the **Axis Use** axis parameter set to **Unused axis (changeable to used axis)** or **Used axis**. You cannot change the setting of the Axis Use axis parameter to **Used axis** if that axis is set to **Unused axis (unchangeable to used axis)**.
- You can execute this instruction when home is defined or when home is not defined. If home is defined and the axis setting is changed to **Unused axis**, the home definition is lost.
- If you change the setting of an axis that uses an absolute encoder from **Used axis** to **Unused axis**, the **absolute encoder home offset** will be the same value as set just before the axis setting change to **Unused axis**, and this value will be saved to the internal memory of the CPU Unit when the power supply to the CPU Unit is turned OFF.



### Precautions for Correct Use

- You cannot change an axis to a used axis if the axis number exceeds the highest axis number that can be controlled by the CPU Unit. The number of real axes that you can change to used axes is the maximum number of used real axes.

Item	NX701-17□□	NX701-16□□
Settable axis numbers	0-255	0-127
Maximum number of used real axes	256 axes	128 axes

Item	NX502-17□□*1	NX502-16□□*1	NX502-15□□	NX502-14□□	NX502-13□□
Settable axis numbers	0 to 255	0 to 127	0 to 63	0 to 31	0 to 15
Maximum number of used real axes	256 axes	128 axes	64 axes	32 axes	16 axes

\*1. Models added from the CPU Unit version 1.66.

Item	NX102-12□□	NX102-11□□	NX102-10□□	NX102-90□□
Settable axis numbers	0 to 14	0 to 14	0 to 14	0 to 3
Maximum number of used real axes	12 axes	8 axes	6 axes	4 axes
Used motion control servo axes	8 axes	4 axes	2 axes	---
Used single-axis position control servo axes	4 axes	4 axes	4 axes	4 axes

Item	NX1P2-11□□	NX1P2-10□□	NX1P2-90□□	NX1P2-9B□□
Settable axis numbers	0 to 11	0 to 9	0 to 3	0 or 1
Maximum number of used real axes	8 axes	6 axes	4 axes	2 axes
Used motion control servo axes	4 axes	2 axes	---	---
Used single-axis position control servo axes	4 axes	4 axes	4 axes	2 axes

Item	NJ501-		
	□5□□	□4□□	□3□□
Settable axis numbers	0 to 63	0 to 31	0 to 15
Maximum number of used real axes	64 axes	32 axes	16 axes

Item	NJ301-12□□	NJ301-11□□	NJ101-10□□
Settable axis numbers	0 to 14*1	0 to 14*2	0 to 5
Maximum number of used real axes	8 axes	4 axes	2 axes

\*1. The range of axis number is 0 to 7 for a CPU Unit with unit version 1.05 or earlier.

\*2. The range is 0 to 3 for a CPU Unit with unit version 1.05 or earlier.

- Either `_MC_AX[*].Status.Disabled` (Axis Disabled) or `_MC_AX[*].Status.Standstill` (Standstill) in the Axis Variable must be TRUE to execute this instruction. If both of them are FALSE, an error will occur when you execute the instruction.
- An error will occur if you execute this instruction when `_MC_AX[*].Details.VelLimit` (Command Velocity Saturation) in the Axis Variable is TRUE.

- If the Axis Use variable of an axis is set to `_mcUnusedAxis` (unused axis), you cannot overwrite the axis parameter settings with the `MC_Write` (Write MC Setting) instruction. Change the Axis Use variable of the axis to `_mcUsedAxis` (used axis) before you execute the `MC_Write` (Write MC Setting) instruction.
- An error occurs if you execute the `MC_GroupEnable` (Enable Axes Group) instruction for an axes group that contains an axis that was changed to **Unused axis** with this instruction.
- If an error occurs in executing this instruction for a used axis, an axis error will occur. If an error occurs in executing this instruction for an unused axis, an MC common error will occur.
- After you change axis usage with this instruction, make sure that the `Done` output variable from this instruction is TRUE before you execute any other motion control instructions.



### Additional Information

For an NX-series CPU Unit, a variable name that starts with `_MC_AX[*]` may start with `_MC1_AX[*]` or `_MC2_AX[*]` instead.

## Timing Charts

MC\_ChangeAxisUse Instruction

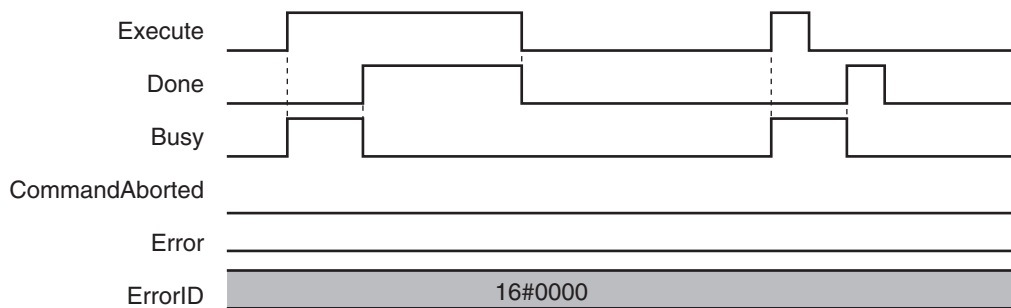

## Re-execution of Motion Control Instructions

This instruction cannot be re-executed.

A Motion Control Instruction Re-execution Disabled error (error code: 543B hex) occurs if re-execution is attempted.

## Multi-execution of Motion Control Instructions

For details on multi-execution of motion control instructions, refer to the *NJ/NX-series CPU Unit Motion Control User's Manual (Cat. No. W507)*.

## Errors

If an error occurs during instruction execution, `Error` will change to TRUE and the setting of the Axis Use axis parameter will not change.

You can find out the cause of the error by referring to the value output by `ErrorID` (Error Code).

### ● Timing Chart When Error Occurs

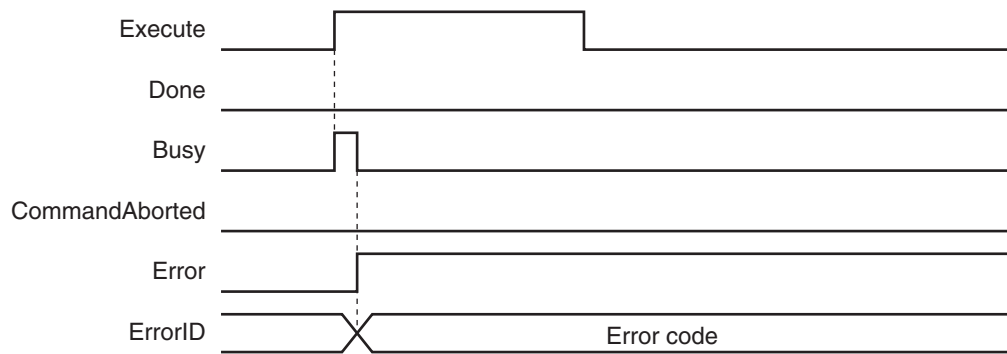

### ● Error Codes

Refer to the *NJ/NX-series Troubleshooting Manual (Cat. No. W503)* for instruction errors.



#### **Precautions for Correct Use**

If an error occurs in executing this instruction for a used axis, an axis error will occur. If an error occurs in executing this instruction for an unused axis, an MC common error will occur.

# MC\_DigitalCamSwitch

The MC\_DigitalCamSwitch instruction turns a digital output ON or OFF according to the axis position.

Instruction	Name	FB/ FUN	Graphic expression	ST expression
MC_DigitalCamSwitch	Enable Digital Cam Switch	FB		<pre>MC_DigitalCamSwitch_instance (   Axis :=parameter,   Switches :=parameter,   Outputs :=parameter,   TrackOptions :=parameter,   Enable :=parameter,   EnableMask :=parameter,   ValueSource :=parameter,   InOperation =&gt;parameter,   Busy =&gt;parameter,   Error =&gt;parameter,   ErrorID =&gt;parameter );</pre>



## Precautions for Safe Use

- Always use the axis at a constant velocity for the MC\_DigitalCamSwitch (Enable Digital Cam Switch) instruction.
- Use the NX\_AryDOutTimeStamp (Write Digital Output Array with Specified Time Stamp) instruction only after you confirm that *InOperation* from the MC\_DigitalCamSwitch (Enable Digital Cam Switch) instruction is TRUE.



## Precautions for Correct Use

- You can use this instruction for the following Units.
  - a) An axis that is assigned to an NX-series Position Interface Unit.  
The applicable NX Units are as follows: NX-EC0□□□ and NX-ECS□□□.
  - b) An OMRON 1S-series Servo Drive with built-in EtherCAT communications.
- Always use this instruction together with the NX\_AryDOutTimeStamp instruction and with a Digital Output Unit that supports time stamp refreshing.



## Version Information

A CPU Unit with unit version 1.06 or later and Sysmac Studio version 1.07 or higher are required to use this instruction.



## Variables

### Input Variables

Name	Meaning	Data type	Valid range	Default	Description
Enable	Enable	BOOL	TRUE or FALSE	FALSE	The instruction is executed while the value of this variable is TRUE. The values in <i>Outputs</i> will not change while the value of this variable is FALSE. *1
EnableMask	Enable Tracks	WORD	16#0000 to FFFF	16#0000	Specify whether to enable or disable each track. There are a maximum of 16 tracks. Specify enable or disable for track 0 with bit 00 and track 15 with bit 15. 0: Disable*2 1: Enable
ValueSource (Reserved)	Input Information	_sMC_SOURCE	---	---	(Reserved)

\*1. The values in *Outputs* (Output Signals) are retained while *Enable* is FALSE. When *Enable* in the NX\_AryDOutTimeStamp instruction is FALSE, the digital output from the Digital Output Unit goes OFF.

\*2. When the value of a bit for a track number in *EnableMask* is **0**, the elements for that track number in *Outputs* (Output Signals) will be OFF.

### Output Variables

Name	Meaning	Data type	Valid range	Description
InOperation	In Operation	BOOL	TRUE or FALSE	TRUE while there are enabled output signals.
Busy	Executing	BOOL	TRUE or FALSE	TRUE when the instruction is acknowledged.
Error	Error	BOOL	TRUE or FALSE	TRUE while there is an error.
ErrorID	Error Code	WORD	*1	Contains the error code when an error occurs. A value of 16#0000 indicates normal execution.

\*1. The upper four digits of the event code give the error code for ErrorID. Refer to the *NJ/NX-series Troubleshooting Manual (Cat. No. W503)* for the event codes.

#### ● Output Variable Update Timing

Name	Timing for changing to TRUE	Timing for changing to FALSE
InOperation	When <i>Enable</i> changes to TRUE.	<ul style="list-style-type: none"> <li>When <i>Enable</i> changes to FALSE.</li> <li>When <i>Error</i> changes to TRUE.</li> </ul>
Busy	When <i>Enable</i> changes to TRUE.	<ul style="list-style-type: none"> <li>When <i>Enable</i> changes to FALSE.</li> <li>When <i>Error</i> changes to TRUE.</li> </ul>
Error	When there is an error in the execution conditions or input parameters for the instruction.	When the error is cleared.

## In-Out Variables

Name	Meaning	Data type	Valid range	Description
Axis	Axis	_sAXIS_REF	---	Specify the axis for which to access the position. *1
Switches	Switches	ARRAY[0..255] OF _sCAMS- WITCH_REF*2	---	Specify an array variable of _sCAMS- WITCH_REF switch structures for use as switch ON/OFF pattern data. The array element numbers indicate the switch numbers.
Outputs	Output Signals	ARRAY[0..15] OF _sOUTPUT_REF*2 *3	---	Specify an array variable of _sOUTPUT_REF output signal structures for use as the output destinations for digital ON/OFF time outputs that are calculated based on switch ON/OFF pattern data. The array element numbers indicate the track numbers. You can specify this array variable as an in-out variable for a NX_AryDOutTimeStamp instruction to actually turn ON and OFF digital outputs.
TrackOptions	Track Options	ARRAY[0..15] OF _sTRACK_REF*2 *3	---	Specify an array variable of _sTRACK_REF track option structures for use as switch operating con- ditions. The array element numbers indicate the track numbers.

- \*1. Specify a user-defined Axis Variable that was created in the Axis Basic Settings of the Sysmac Studio (default: MC\_Axis\*) or a system-defined axis variable name (\_MC\_AX[\*], \_MC1\_AX[\*], or \_MC2\_AX[\*]).  
If you use Sysmac Studio version 1.29 or higher, you can specify the system-defined axis variable name for AT specification of a user-defined variable. This will allow you to specify the user-defined variable.  
If you use Sysmac Studio version 1.28 or lower, do not specify any user-defined variable created in the variable table.
- \*2. An error will occur if the first element number in the array is not 0. An error will also occur if an array with more than one dimension is specified.
- \*3. An error will occur if the number of elements in *Outputs* and the number of elements in *TrackOptions* are not the same.

## Function

- The MC\_DigitalCamSwitch instruction outputs the times when the actual position of an axis will reach positions that are set in *Switches* as the times for turning a digital output ON and OFF.
- Always use this instruction together with the NX\_AryDOutTimeStamp instruction and with a Digital Output Unit that supports time stamp refreshing.
- The NX\_AryDOutTimeStamp instruction turns the specified digital output ON or OFF at the specified time stamp. If you use time stamp refreshing, you can turn digital output signals ON and OFF at the required time without being affected by the timing of control processing.



### Precautions for Correct Use

- This instruction is not sufficient to actually turn digital outputs ON and OFF.
- If you use an NX-series Encoder Input Unit, this instruction requires that time stamping is operating.  
Time stamping is not possible in the following cases.
  - a) An Encoder Input Unit or Servo Drive that does not support time stamping is used.
  - b) Object 6010 hex (Time Stamp) in the NX-series Encoder Input Unit is not assigned to a PDO.
  - c) The **Enable Distributed Clock** in the EtherCAT Coupler Unit is **Disabled (FreeRun)**.
- If you use an OMRON 1S-series Servo Drive with built-in EtherCAT communications, this instruction is not possible in the following cases.
  - a) Object 3211-83 hex (Present Position Time Stamp) in the OMRON 1S-series Servo Drive with built-in EtherCAT communications is not assigned to a PDO.
  - b) The **Enable Distributed Clock** in the OMRON 1S-series Servo Drive with built-in EtherCAT communications is **Disabled (FreeRun)**.
- An error does not occur for this instruction even if the time stamp is not updated. The ON/OFF time will be calculated, but the result will not be the intended value.  
Use this instruction only after you confirm in the MC Monitor Table or Watch Tab Page of the Sysmac Studio that the *TimeStamp* member of the Axis Variable is being updated.
- If you use this instruction together with the NX\_AryDOutTimeStamp instruction and with a Digital Output Unit that supports time stamp refreshing, the minimum ON/OFF range will be proportional to the value of the task period and the value of the rotation rate.  
For example, the minimum ON/OFF range would be 5° if one rotation of the rotary table is 360°, the rotation rate is 800 r/min, and the task period is 500 μs. The minimum ON/OFF range would become 10° if the task period was increased to 1,000 μs.
- Set the values of the *FirstOnPosition*, *LastOnPosition*, and *Duration* in the switch structure variable so that the ON/OFF range of the digital output is larger than the minimum ON/OFF range. If it is smaller than the minimum ON/OFF range, the actual digital output may not turn ON or OFF.
- This instruction calculates the time stamp for when the specified position is reached based on both the current position and current velocity of the axis. The accuracy of the calculated stamp times is influenced by the encoder resolution and the rotation rate of the axis. The error will increase if the encoder resolution is low or the rotation rate of the axis is slow. You can calculate a guideline for the maximum error with the following formula.

Maximum error in time stamp (s) =  $180 / (\text{Encoder resolution (pulses/rotation)} \times \text{rotation rate (r/min)})$

Some examples of the maximum error in time stamps for the encoder resolution and rotation rate are given in the following table.

Encoder resolution (pulses/rotation)	Rotation rate (r/min)	Maximum error in calculated time stamps (μs)
3600	400	±125.0
	800	±62.5
131072	400	±3.4
	800	±1.7

If the axis accelerates or decelerates quickly, the calculation error may increase. Use this instruction when the axis is at a constant velocity.

Verify operation sufficiently to confirm safety.

- If you specify an unused axis or if the MC Test Run is in progress, *Busy* will change to TRUE and *InOperation* and *Error* will change to FALSE when *Enable* changes to TRUE.
- Do not create two instances with the same instance name. If you do, unintentional outputs may occur.



**Additional Information**

For details on the NX\_AryDOutTimeStamp instruction, refer to the *NJ/NX-series Instructions Reference Manual (Cat. No. W502)*.

**Instruction Details**

You can use this instruction to implement a mechanical cam switch that controls a sensor output signal according to cam rotation angles in a program in the Controller. One track corresponds to one cam.

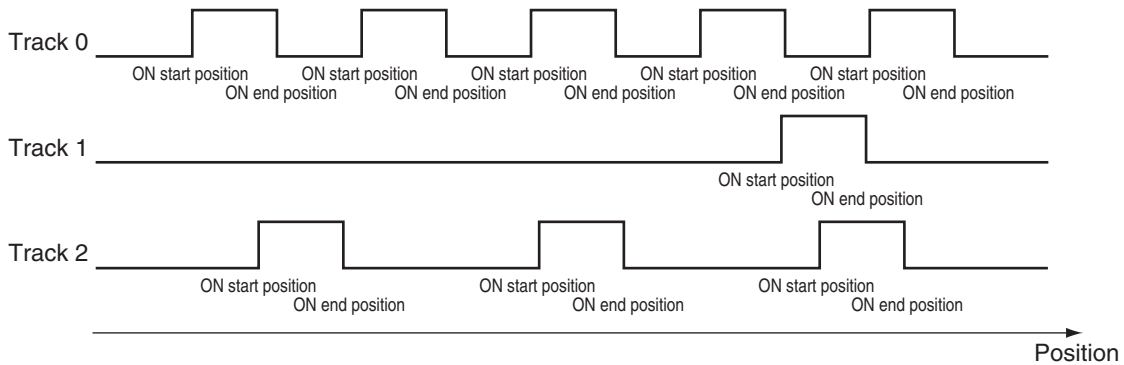
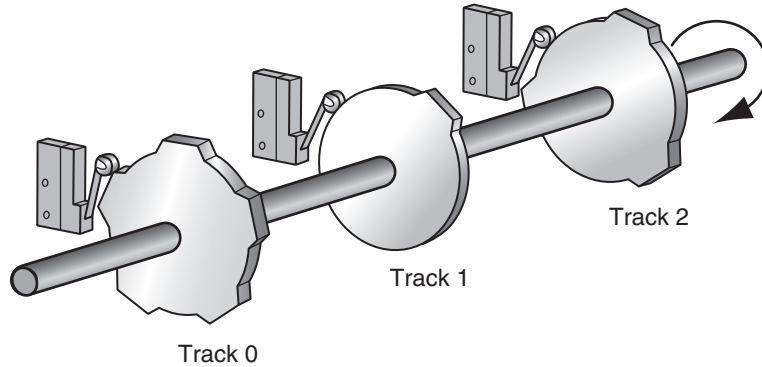

*TrackNumber* corresponds to the cam number. The values of the *FirstOnPosition* (ON Start Position) and *LastOnPosition* (ON End Position) correspond to the shape of the cam.

The MC\_DigitalCamSwitch instruction calculates the *OnTime* (ON Time) and *OffTime* (OFF Time) to reach the specified ON start position and ON end position and stores them in the parameter that is specified for *Outputs* (Output Signals).

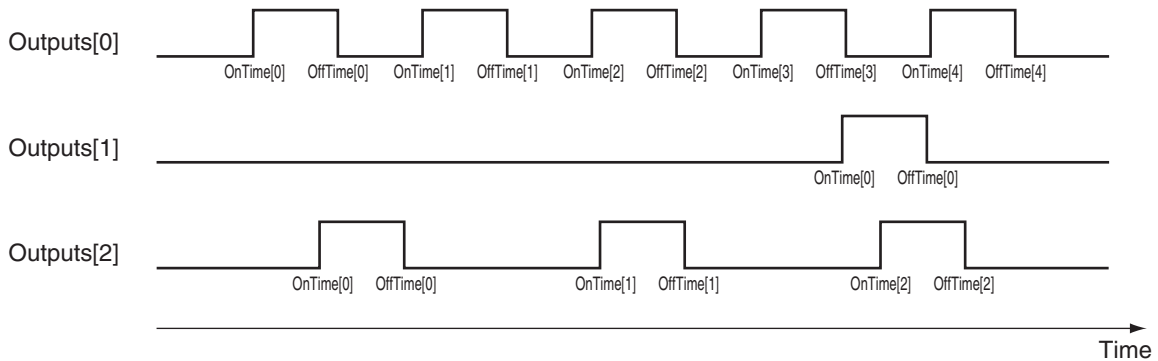

The NX\_AryDOutTimeStamp instruction turns the actual digital outputs ON or OFF according to *OnTime* (ON Time) and *OffTime* (OFF Time) in the parameter that is specified for *SetDOut* (Output Pulses).

For *SetDOut* (Output Pulses), specify the elements of the array variable that is specified for the parameter for *Outputs* (Output Signals) in the MC\_DigitalCamSwitch instruction.

For *DOut* (DOut Unit Output Bit), specify as the actual digital output, the device variable that is assigned to the output bit of the Digital Output Unit that supports time stamp refreshing.

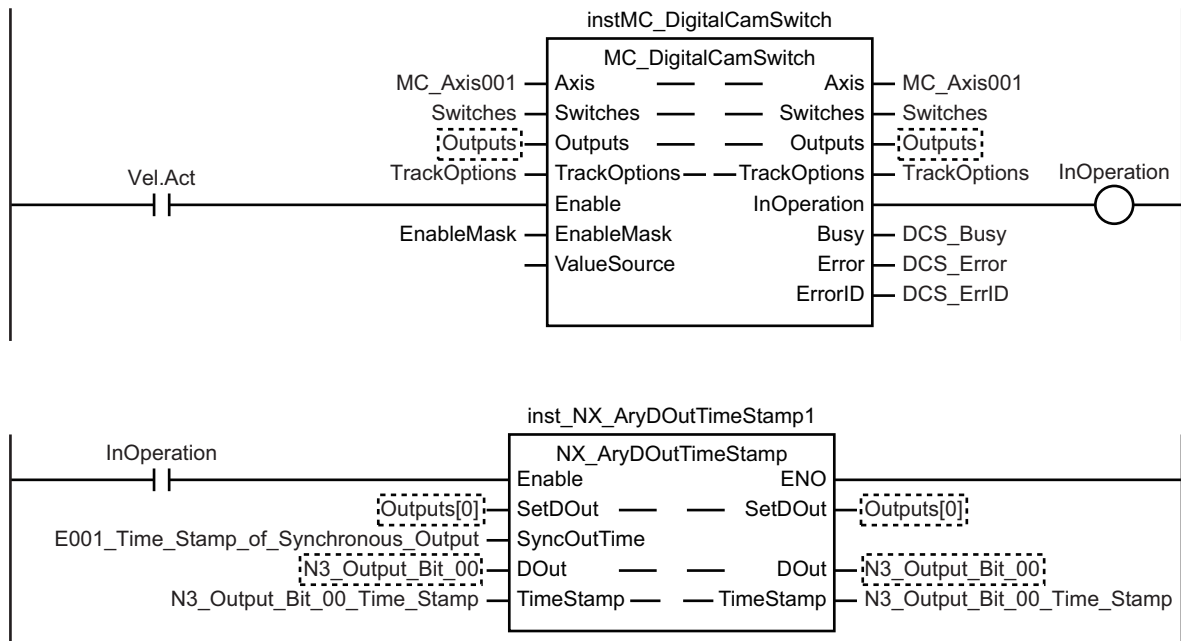

The instruction variables are described next.

### ● Enable

- The instruction is executed while *Enable* is TRUE. The values in *Outputs* will not change while the variable is FALSE.

### ● EnableMask (Enable Tracks)

- With *EnableMask* (Enable Tracks), you can specify whether each track is enabled or disabled when *Enable* is TRUE. To turn OFF the output from the Digital Output Unit, disable the corresponding track.
- Bit 00 corresponds to track 0 and bit 15 corresponds to track 15. The corresponding track is enabled if a bit is set to 1 and disabled if the bit is set to 0. If you change the value of a bit from 1 to 0, the digital output for the corresponding track will be turned OFF.
- The values that are specified in *EnableMask* are shown in *EnableOut* for the corresponding track numbers.

### ● Switch Structure (\_sCAMSWITCH\_REF Data Type)

The switch structure (`_sCAMSWITCH_REF`) is used to specify the ON/OFF pattern for the output signal. You can specify up to 256 ON/OFF patterns for this instruction with an array variable. You can specify up to 16 ON/OFF patterns for one track.

The following table shows the members of the switch structure.

Name	Meaning	Data type	Valid range	Default	Description
TrackNumber	Track Number	UINT	0 to 15*1	0	Specify the applicable track number.
FirstOnPosition	ON Start Position	LREAL	Negative number, positive number, or 0	0	Specify the position for the output to turn ON. *2
LastOnPosition	ON End Position	LREAL	Negative number, positive number, or 0	0	Specify the position for the output to turn OFF. *2 This member is valid when the Switch Mode Selection is set for position-based operation.
AxisDirection	Axis Direction Selection	_eMC_DIRECTION	0: _mcPositiveDirection 2: _mcNegativeDirection 4: _mcNoDirection	0*3	Specify the rotation direction. 0: Positive direction 2: Negative direction 4: No direction specified (both directions).
CamSwitchMode	Switch Mode Selection	_eMC_SWITCH_MODE	0: _mcSwitchDisable 1: _mcPositionBased 2: _mcTimeBased	0*3	Specify the Switch Mode. 0: Switch disabled. 1: Position based*4 2: Time based*5
Duration	ON Duration	TIME	Positive number or T#0s	T#0s	Specify the time for the output to turn ON. This member is valid when the Switch Mode Selection is set for time-based operation.

- \*1. You can specify up to the highest element number for the variable that is specified for *Outputs* (Output Signals).
- \*2. The unit is command units. The command unit is millimeters, micrometers, nanometers, degrees, inches, or pulses. When the Count Mode is set to **Linear Mode**, the setting range when the value is converted to pulses is 40 bits (signed integer: 0x8000000000 to 0x7FFFFFFF). When the Count Mode is set to **Rotary Mode**, the setting range is from greater than or equal to the modulo minimum position to less than the modulo maximum position.
- \*3. The default value for an enumeration variable is actually not the number, but the enumerator.
- \*4. If you specify **1 (\_mcPositionBased)**, operation is based on the values of *FirstOnPosition* (ON Start Position) and *LastOnPosition* (ON End Position). The value of *Duration* (ON Duration) is ignored.
- \*5. If you specify **2 (\_mcTimeBased)**, operation is based on the values of *FirstOnPosition* (ON Start Position) and *Duration* (ON Duration). The value of *LastOnPosition* (ON End Position) is ignored.

#### Setting Example

Name	Meaning	Switch 0	Switch 1	Switch 2	Switch 3	...	Switch 255
TrackNumber	Track Number	0	0	0	1		
FirstOnPosition	ON Start Position	2000.0	2500.0	4000.0	3000.0		
LastOnPosition	ON End Position	3000.0	3000.0	1000.0	...*1		
AxisDirection	Axis Direction Selection	Positive direction	Negative direction	No direction specified	No direction specified		
CamSwitchMode	Switch Mode Selection	Position based	Position based	Position based	Time based		
Duration	ON Duration	...*2	...*2	...*2	T#1350ms		

- \*1. When the Switch Mode Selection is set for time-based operation, operation is performed with the ON Start Position and ON Duration. The value of the ON End Position is ignored.
- \*2. When the Switch Mode Selection is set for position-based operation, operation is performed with the ON Start Position and ON End Position. The value of the ON Duration is ignored.

The operation is as shown below when the axis continuously rotates in the positive direction. Here, the Count Mode is set to **Rotary Mode** and the ring counter range is set to 0 to 5000 in the axis parameters.

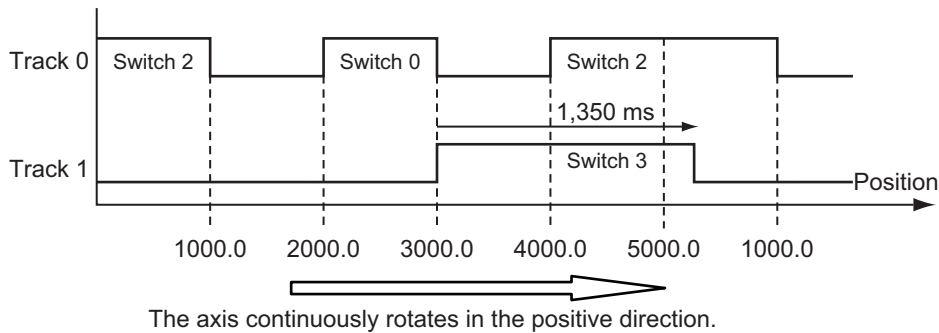

The operation is as shown below when the axis continuously rotates in the negative direction. The axis parameter settings are the same as those that are given above.

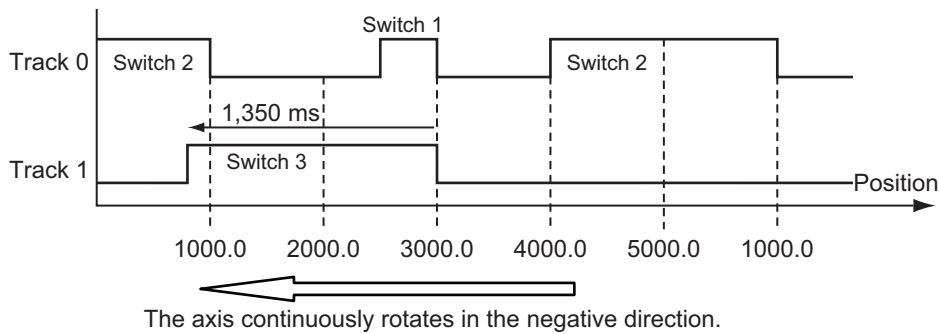

● **Output Signal Structure (\_sOUTPUT\_REF Data Type)**

The output signal structure (\_sOUTPUT\_REF) is used to give the ON/OFF times for digital signals that are calculated based on the switch ON/OFF pattern data. This instruction can handle up to 16 array elements in the *Outputs* (Output Signals). The array element numbers in *Outputs* (Output Signals) indicate the track numbers.

The following table shows the members of the output signal structure.

Name	Meaning	Data type	Valid range	Description
EnableOut	Enable Output	BOOL	TRUE or FALSE	Specify whether the outputs for the relevant track numbers are enabled or disabled. The value of the bit for the same track number in <i>EnableMask</i> is given. *1 TRUE: The output for the relevant track number is enabled. FALSE: The output for the relevant track number is disabled.
OnTime	ON Time	ARRAY [0..15] OF ULINT	Non-negative number	The time stamps at which to turn ON the digital output are given. The time stamps are based on the time in the NX-series Encoder Input Unit. The value is refreshed every task period. The unit is nanoseconds.

Name	Meaning	Data type	Valid range	Description
OffTime	OFF Time	ARRAY [0..15] OF ULINT	Non-negative number	The time stamps at which to turn OFF the digital output are given. The time stamps are based on the time in the NX-series Encoder Input Unit. The value is refreshed every task period. The unit is nanoseconds.

\*1. The value of bit *i* in *EnableMask* is given in *Outputs[i].EnableOut*.

### ● Track Option Structure (\_sTRACK\_REF Data Type)

The track option structure (\_sTRACK\_REF) is used to specify the operating condition for a switch. You can specify up to 16 output conditions for this instruction with an array variable.

The variable that is specified for *TrackOptions* and the variable that is specified for *Outputs* must have the same number of array elements.

The following table shows the members of the track option structure.

Name	Meaning	Data type	Valid range	Default	Description
OnCompensation	ON Time Compensation	TIME	T#-1s to T#1s* <sup>1</sup>	T#0s	This variable compensates the time at which an output is turned ON. The time is delayed for a positive value and advanced for a negative value.
OffCompensation	OFF Time Compensation	TIME	T#-1s to T#1s* <sup>1</sup>	T#0s	This variable compensates the time at which an output is turned OFF. The time is delayed for a positive value and advanced for a negative value.

\*1. If the Count Mode is set to **Rotary Mode**, the following restrictions exist depending on the unit version of the CPU Unit.

- For a CPU Unit with unit version 1.09 or later, *InOperation* will be FALSE if a value is set that exceeds the range of plus/minus half a rotation of the axis.
- For a CPU Unit with unit version 1.08 or earlier, the valid range is T#-1s to T#0s.

*OnCompensation* (ON Time Compensation) and *OffCompensation* (OFF Time Compensation) are used to correct minor machine operation delays and offsets.





### Precautions for Safe Use

Always use the axis at a constant velocity for the MC\_DigitalCamSwitch instruction.

If you set the Count Mode to **Rotary Mode**, the following operation will occur if you use *OnCompensation* or *OffCompensation* and the axis velocity changes abruptly.

- If the value of *OnCompensation* or *OffCompensation* is equivalent to the time for half a rotation or more, *InOperation* will be FALSE.
- If the value of *OnCompensation* results in exceeding *LastOnPosition*, the output timing will be unstable.

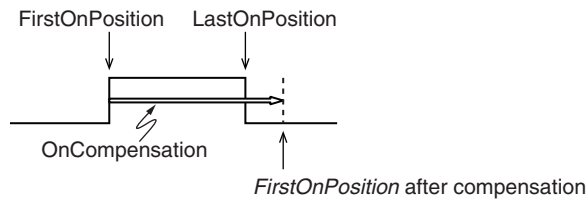

- If the value of *OffCompensation* results in exceeding *FirstOnPosition*, the output timing will be unstable.

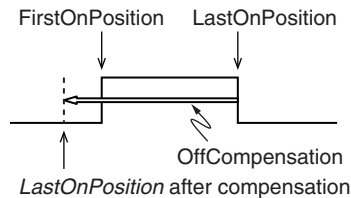

### Precautions for Correct Use

If you set the Count Mode to **Rotary Mode** and use *OnCompensation* or *OffCompensation*, set the parameters so that the relationship between *FirstOnPosition* and *LastOnPosition* is not reversed.

The output timing will be unstable.

Refer to "Precautions for Safe Use", above, for operation information.



### Version Information

If the Count Mode is set to **Rotary Mode**, the following restrictions exist depending on the unit version of the CPU Unit.

The valid range is different for a CPU Unit with unit version 1.09 or later and a CPU Unit with unit version 1.08 or earlier. Check the valid range if you upgrade to a CPU Unit with unit version 1.09 or later.

#### CPU Unit with Unit Version 1.09 or Later

The valid range is T#-1s to T#1s, but the following restrictions also apply to the setting.

- Set the value within a range that does not exceed the time for half a rotation of the axis.  
For example, for rotation at 500 r/min, the time for one rotation is 120 ms. The time is for half a rotation, so set *OnCompensation* (ON Time Compensation) and *OffCompensation* (OFF Time Compensation) to between -60 and 60 ms.
- If a value is set that exceeds the time for half a rotation of the axis, *InOperation* will be FALSE and *EnableOut* will be FALSE. Always check the status of *InOperation* during application.
- If a value within the correct range is restored when *InOperation* is FALSE, *InOperation* will change to TRUE.

#### CPU Unit with Unit Version 1.08 or Earlier

- The valid range is T#-1s to T#0s.

The following figure shows the operation when *OnCompensation* (ON Time Compensation) is set to T#5ms and *OffCompensation* (OFF Time Compensation) is set to T#10ms for the Setting Example given on page 3-430.

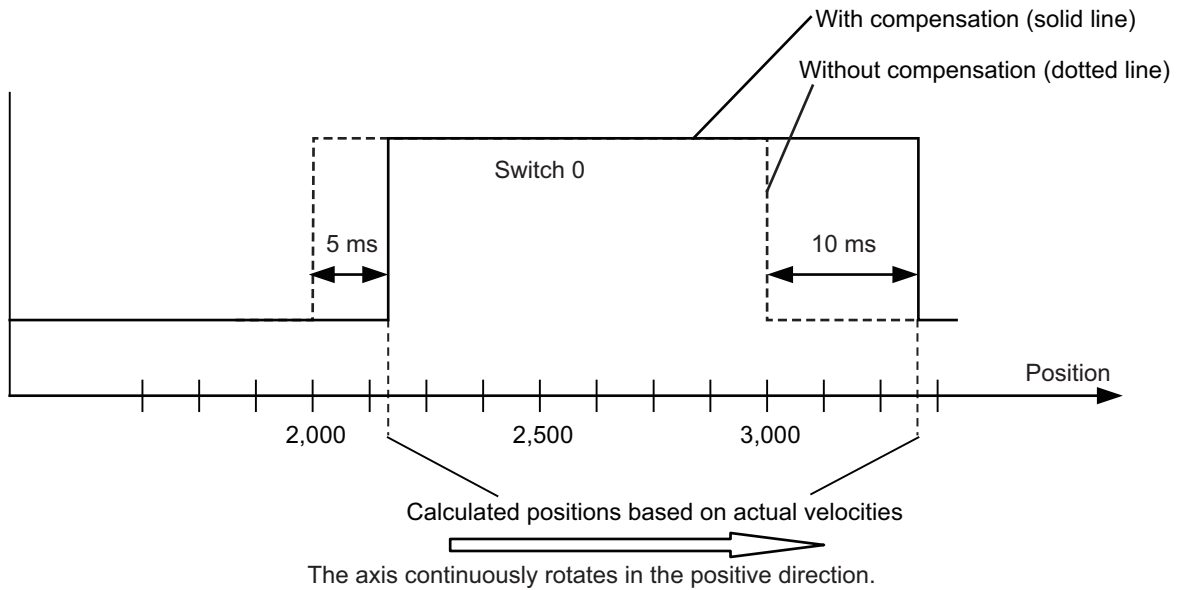

## Timing Charts

A timing chart for execution of the MC\_DigitalCamSwitch (Enable Digital Cam Switch) instruction is shown below.

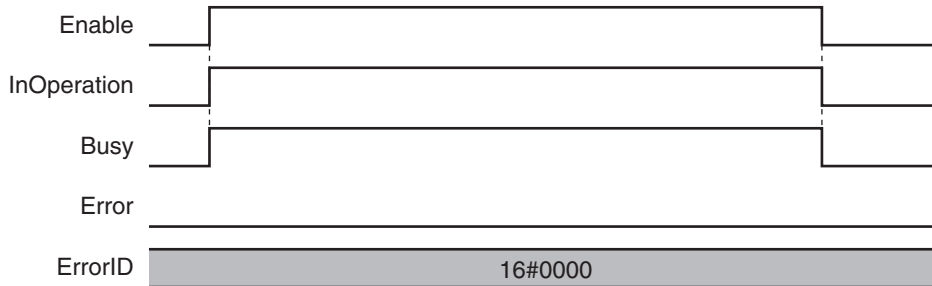

The following timing chart is for when an unused axis is specified or when an MC Test Run is in progress.

For a CPU Unit with unit version 1.09 or later, the timing chart will be the same if the Count Mode is **Rotary Mode** and *OnCompensation* (ON Time Compensation) or *OffCompensation* (OFF Time Compensation) is set to a time that exceeds half a rotation of the axis.

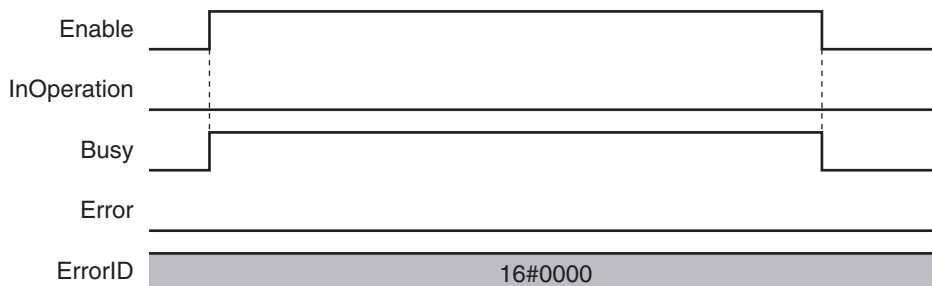

Here, *EnableOut* in *Outputs* will be FALSE.

## Re-execution of Motion Control Instructions

You cannot re-execute motion instructions with enable-type inputs.

## Multi-execution of Motion Control Instructions

This instruction is executed independently from other instructions. The restrictions for multi-execution of motion instructions do not apply.

For details on multi-execution of motion control instructions, refer to the *NJ/NX-series CPU Unit Motion Control User's Manual (Cat. No. W507)*.

## Errors

If an error occurs during instruction execution, *Error* will change to TRUE.

You can find out the cause of the error by referring to the value output by *ErrorID* (Error Code).

### ● Timing Chart When Error Occurs

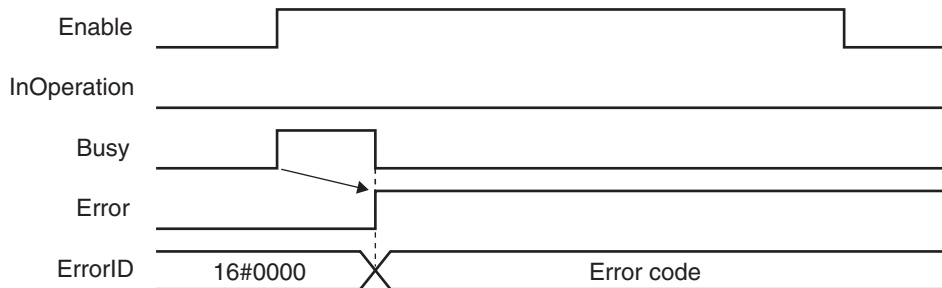

Here, *EnableOut* in *Outputs* will be FALSE.

### ● Error Codes

Refer to the *NJ/NX-series Troubleshooting Manual (Cat. No. W503)* for instruction errors.

## Sample Programming

This section provides sample programming for the example that is given in Setting Example on page 3-430.

## Configuration Devices

The following devices are used in this sample programming.

Device	Model number
EtherCAT Coupler Unit	NX-ECC201 (Ver.1.1)* <sup>1</sup>
Pulse Output Unit	NX-PG0122* <sup>2</sup>

Device	Model number
Incremental Encoder Input Unit	NX-EC0122*3
Digital Output Unit	NX-OD2154*4

\*1. The node address is 1 and the device name is E001.

\*2. The NX Unit number is 1 and the device name is N1. It is assigned to axis 1.

\*3. The NX Unit number is 2 and the device name is N2. It is assigned to axis 2.

\*4. The NX Unit number is 3 and the device name is N3.

## Parameter Settings

The minimum settings required for this sample programming are given below.

### ● Axis Parameters

#### Axis Types

Axis	Axis type
Axis 1	Servo axis
Axis 2	Encoder axis

#### Count Modes

Axis	Count Mode
Axis 1	Rotary Mode
Axis 2	Rotary Mode

#### Ring Counters

Axis	Modulo maximum position	Modulo minimum position
Axis 1	5000	0
Axis 2	5000	0

#### Unit of Display

Axis	Unit of Display
Axis 1	pulse
Axis 2	pulse

## Ladder Diagram

### ● Main Variables

Name	Data type	Default	Comment
MC_Axis000	_sAXIS_REF	---	Axis Variable for axis 1.
MC_Axis001	_sAXIS_REF	---	Axis Variable for axis 2.
E001_Time_Stamp_of_Synchronous_Output	ULINT	---	Device variable *1
N3_Output_Bit_00	BOOL	---	Device variable
N3_Output_Bit_00_Time_Stamp	ULINT	---	Device variable
N3_Output_Bit_01	BOOL	---	Device variable

Name	Data type	Default	Comment
N3_Output_Bit_01_Time_Stamp	ULINT	---	Device variable
Switches	ARRAY[0..3] OF _sCAMSWITCH_REF	---	Input parameter for <i>Switches</i> in-out variable. The element numbers correspond to the switch numbers.
Outputs	ARRAY[0..1] OF _sOUTPUT_REF	---	Input parameter for <i>Outputs</i> in-out variable. The element numbers correspond to the track numbers.
TrackOptions	ARRAY[0..1] OF _sTRACK_REF	---	Input parameter for <i>TrackOptions</i> in-out variable. The element numbers correspond to the track numbers.
EnableMask	WORD	16#0003	Input parameter for <i>EnableMask</i> input variable. Tracks 0 and 1 are enabled.

\*1. You must add 0x200A:02 (Time Stamp of Synchronous Output) to the I/O entries for the EtherCAT Coupler Unit.

● Sample Programming

If *StartPg* is TRUE, check that the Servo Drive for axis 1 is ready.

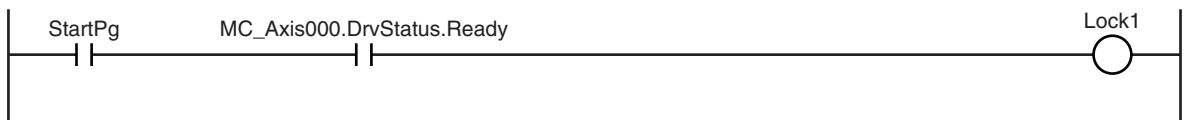

If the Servo Drive for axis 1 is ready, the Servo is turned ON.

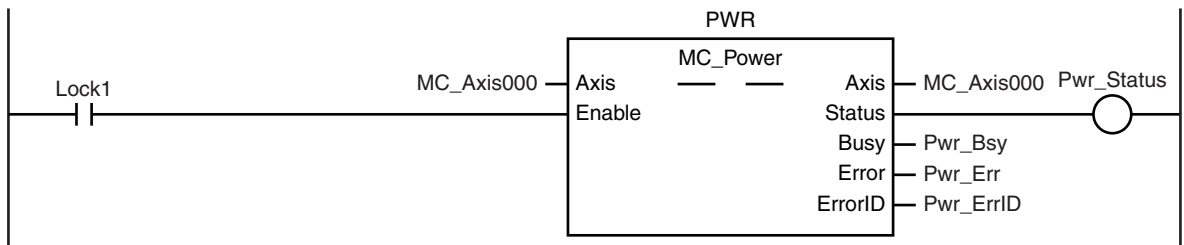

If a minor fault level error occurs for the axis composition, the error handler for the device (FaultHandler) is executed.  
Program the FaultHandler according to the device.

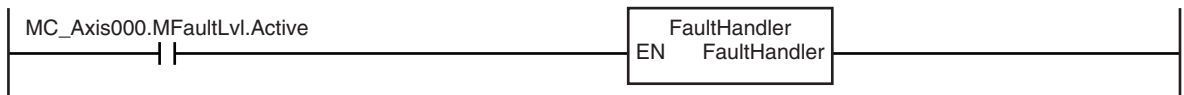

If the Servo is ON for axis 1 and home is not defined, the Home instruction is executed to define home.

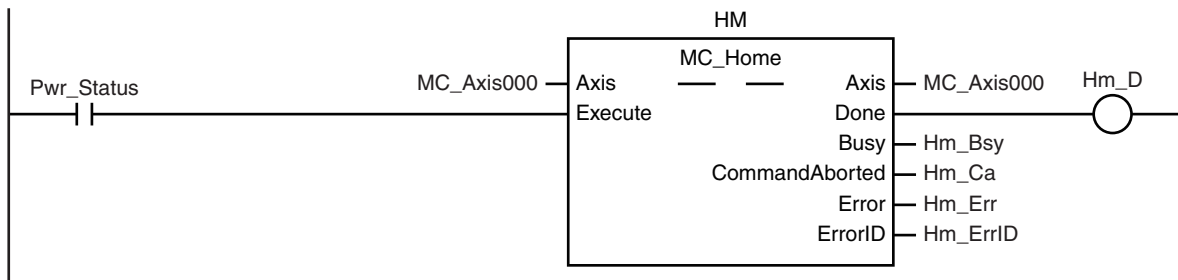

The parameters are set for the MC\_MoveVelocity (Velocity Control) instruction and for the Switches variables for the MC\_DigitalCamSwitch (Enable Digital Cam Switch) instruction.

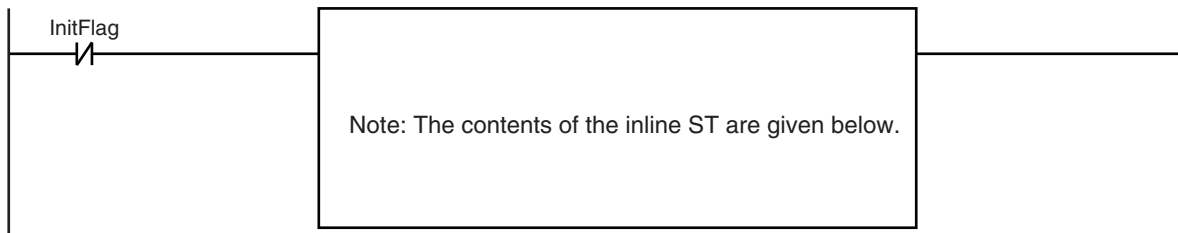

The MC\_MoveVelocity (Velocity Control) instruction is executed if home is defined for axis 1.

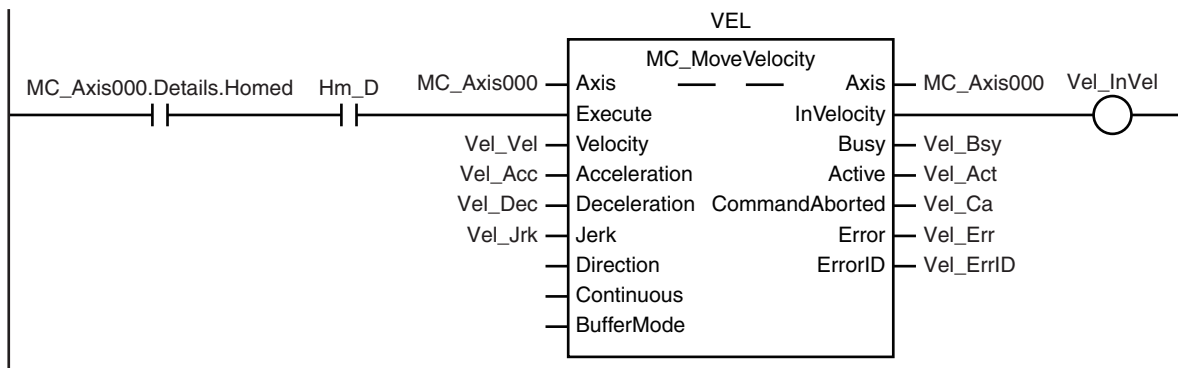

After the MC\_MoveVelocity (Velocity Control) instruction is executed for axis 1, the MC\_DigitalCamSwitch (Enable Digital Cam Switch) instruction is executed for axis 2.

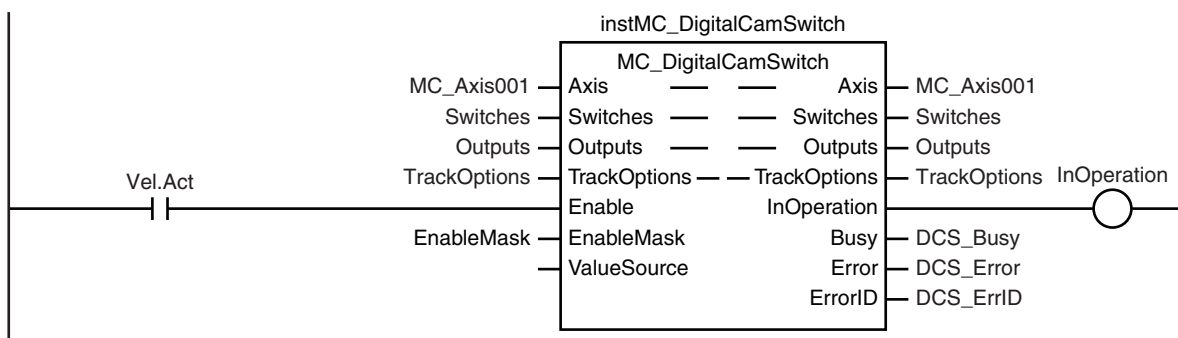

After the MC\_DigitalCamSwitch (Enable Digital Cam Switch) instruction for axis 2 starts operating, the NX\_AryDOutTimeStamp (Write Digital Output Array with Specified Time Stamps) instruction is executed.

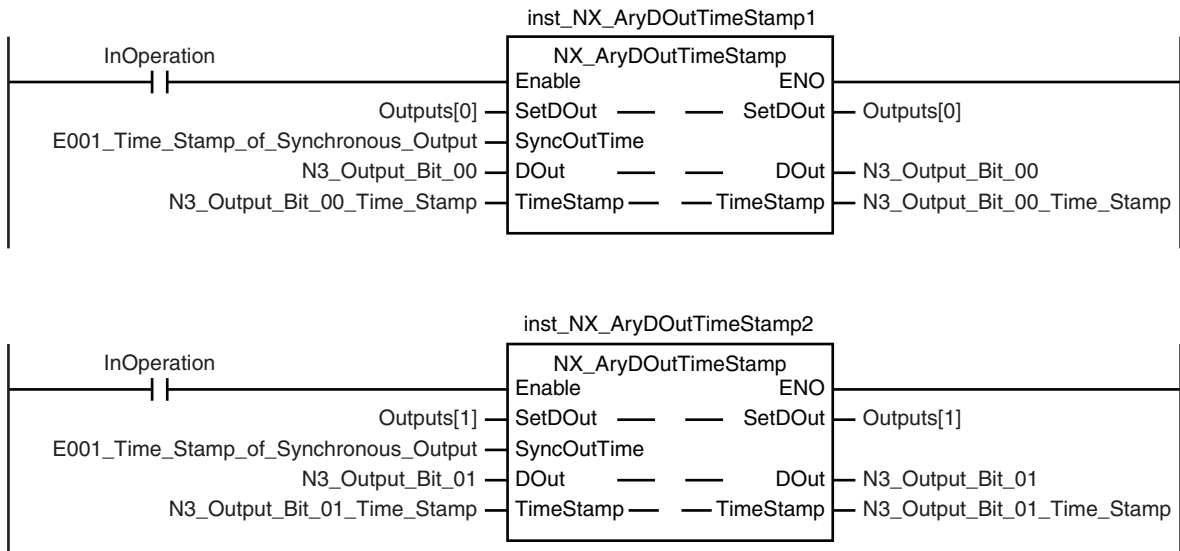

### Contents of Inline ST

```
//MC_MoveVelocity parameters
Vel_Vel := LREAL#1000.0;
Vel_Acc := LREAL#0.0;
Vel_Dec := LREAL#0.0;
Vel_Jrk := LREAL#1000.0;
InitFlag := BOOL#TRUE;

//MC_DigitalCamSwitch parameters
Switches[0].TrackNumber := UINT#0;
Switches[0].FirstOnPosition := LREAL#2000.0;
Switches[0].LastOnPosition := LREAL#3000.0;
Switches[0].AxisDirection := _eMC_DIRECTION#_mcPositiveDirection;
Switches[0].CamSwitchMode := _eMC_SWITCH_MODE#_mcPositionBased;

Switches[1].TrackNumber := UINT#0;
Switches[1].FirstOnPosition := LREAL#2500.0;
Switches[1].LastOnPosition := LREAL#3000.0;
Switches[1].AxisDirection := _eMC_DIRECTION#_mcNegativeDirection;
Switches[1].CamSwitchMode := _eMC_SWITCH_MODE#_mcPositionBased;

Switches[2].TrackNumber := UINT#0;
Switches[2].FirstOnPosition := LREAL#4000.0;
Switches[2].LastOnPosition := LREAL#1000.0;
Switches[2].AxisDirection := _eMC_DIRECTION#_mcNoDirection;
Switches[2].CamSwitchMode := _eMC_SWITCH_MODE#_mcPositionBased;

Switches[3].TrackNumber := UINT#1;
Switches[3].FirstOnPosition := LREAL#3000.0;
Switches[3].Duration := T#1350ms;
```

```
Switches[3].AxisDirection := _eMC_DIRECTION#_mcNoDirection;
Switches[3].CamSwitchMode := _eMC_SWITCH_MODE#_mcTimeBased;
```

## Structured Text (ST)

### ● Main Variables

Name	Data type	Default	Comment
MC_Axis000	_sAXIS_REF	---	Axis Variable for axis 1.
MC_Axis001	_sAXIS_REF	---	Axis Variable for axis 2.
E001_Time_Stamp_of_Synchronous_Output	ULINT	---	Device variable <sup>*1</sup>
N3_Output_Bit_00	BOOL	---	Device variable
N3_Output_Bit_00_Time_Stamp	ULINT	---	Device variable
N3_Output_Bit_01	BOOL	---	Device variable
N3_Output_Bit_01_Time_Stamp	ULINT	---	Device variable
Pwr_En	BOOL	---	This variable is assigned to the <i>Enable</i> input variable from the PWR instance of the MC_Power instruction.
Switches	ARRAY[0..3] OF _sCAMSWITCH_REF	---	Input parameter for <i>Switches</i> in-out variable. The element numbers correspond to the switch numbers.
Outputs	ARRAY[0..1] OF _sOUTPUT_REF	---	Input parameter for <i>Outputs</i> in-out variable. The element numbers correspond to the track numbers.
TrackOptions	ARRAY[0..1] OF _sTRACK_REF	---	Input parameter for <i>TrackOptions</i> in-out variable. The element numbers correspond to the track numbers.
EnableMask	WORD	16#0003	Input parameter for <i>EnableMask</i> input variable. Tracks 0 and 1 are enabled.
Hm_Ex	BOOL	FALSE	The HM instance of MC_Home is executed when this variable changes to TRUE.
Vel_Ex	BOOL	FALSE	The VEL instance of MC_MoveVelocity is executed when this variable changes to TRUE.

\*1. You must add 0x200A:02 (Time Stamp of Synchronous Output) to the I/O entries for the EtherCAT Coupler Unit.

### ● Sample Programming

```
//Processing when input parameters are not set
IF InitFlag=FALSE THEN

    //MC_MoveVelocity parameters
```



```

Vel_Vel := LREAL#1000.0;
Vel_Acc := LREAL#0.0;
Vel_Dec := LREAL#0.0;
Vel_Jrk := LREAL#1000.0;

//MC_DigitalCamSwitch parameters
Switches[0].TrackNumber := UINT#0;
Switches[0].FirstOnPosition := LREAL#2000.0;
Switches[0].LastOnPosition := LREAL#3000.0;
Switches[0].AxisDirection :=_eMC_DIRECTION#_mcPositiveDirection;
Switches[0].CamSwitchMode :=_eMC_SWITCH_MODE#_mcPositionBased;
Switches[1].TrackNumber := UINT#0;
Switches[1].FirstOnPosition := LREAL#2500.0;
Switches[1].LastOnPosition := LREAL#3000.0;
Switches[1].AxisDirection :=_eMC_DIRECTION#_mcNegativeDirection;
Switches[1].CamSwitchMode :=_eMC_SWITCH_MODE#_mcPositionBased;
Switches[2].TrackNumber := UINT#0;
Switches[2].FirstOnPosition := LREAL#4000.0;
Switches[2].LastOnPosition := LREAL#1000.0;
Switches[2].AxisDirection :=_eMC_DIRECTION#_mcNoDirection;
Switches[2].CamSwitchMode :=_eMC_SWITCH_MODE#_mcPositionBased;
Switches[3].TrackNumber := UINT#1;
Switches[3].FirstOnPosition := LREAL#3000.0;
Switches[3].Duration := T#1350ms;
Switches[3].AxisDirection :=_eMC_DIRECTION#_mcNoDirection;
Switches[3].CamSwitchMode :=_eMC_SWITCH_MODE#_mcTimeBased;

//InitFlag is changed to TRUE after input parameters are set.
InitFlag:=TRUE;

END_IF;

//If StartPg is TRUE and the Servo Drive is ready, the Servo for axis 1 is turned ON.
//If the Servo Drive is not ready, the Servo is turned OFF.
IF (StartPg=TRUE)
  AND (MC_Axis000.DrvStatus.Ready=TRUE) THEN
    Pwr_En:=TRUE;
  ELSE
    Pwr_En:=FALSE;
  END_IF;

//If a minor fault level error occurs for axis 1, the error handler for the device
(FaultHandler) is executed.
//Program the FaultHandler according to the device.
IF MC_Axis000.MFaultLvl.Active=TRUE THEN
  FaultHandler();

```

```
END_IF;

//If the Servo is ON and home is not defined, the Home instruction is executed.
IF (Pwr_Status=TRUE) THEN
    Hm_Ex:=TRUE;
END_IF;

//After home is defined, MC_MoveVelocity is executed.
IF MC_Axis000.Details.Homed=TRUE AND Hm_D=TRUE THEN
    Vel_Ex:=TRUE;
END_IF;

//MC_Power
PWR(
    Axis := MC_Axis000,
    Enable := Pwr_En,
    Status => Pwr_Status,
    Busy => Pwr_Bsy,
    Error => Pwr_Err,
    ErrorID => Pwr_ErrID
);

//MC_Home
HM(
    Axis := MC_Axis000,
    Execute := Hm_Ex,
    Done => Hm_D,
    Busy => Hm_Bsy,
    CommandAborted => Hm_Ca,
    Error => Hm_Err,
    ErrorID => Hm_ErrID
);

//MC_MoveVelocity
VEL(
    Axis := MC_Axis000,
    Execute := Vel_Ex,
    Velocity := Vel_Vel,
    Acceleration := Vel_Acc,
    Deceleration := Vel_Dec,
    Jerk := Vel_Jrk,
    InVelocity => Vel_InVel,
    Busy => Vel_Bsy,
    Active => Vel_Act,
    CommandAborted => Vel_Ca,
    Error => Vel_Err,
    ErrorID => Vel_ErrID
);
```

```
);

//MC_DigitalCamSwitch
instMC_DigitalCamSwitch(
    Axis := MC_Axis001,
    Switches := Switches,
    Outputs := Outputs,
    TrackOptions := TrackOptions,
    Enable := Vel_Act,
    EnableMask := EnableMask,
    InOperation => InOperation,
    Busy => DCS_Busy,
    Error => DCS_Error,
    ErrorID => DCS_ErrorID );

inst_NX_AryDOutTimeStamp1(
    Enable := Vel_Act,
    SetDOut := Outputs[0],
    SyncOutTime :=E001_Time_Stamp_of_Synchronous_Output,
    DOut := N3_Output_Bit_00,
    TimeStamp := N3_Output_Bit_00_Time_Stamp);

inst_NX_AryDOutTimeStamp2(
    Enable := Vel_Act,
    SetDOut := Outputs[1],
    SyncOutTime :=E001_Time_Stamp_of_Synchronous_Output,
    DOut := N3_Output_Bit_01,
    TimeStamp := N3_Output_Bit_01_Time_Stamp);
```

# MC\_TimeStampToPos

The MC\_TimeStampToPos instruction calculates the position of the axis for the specified time stamp.

Instruction	Name	FB/ FUN	Graphic expression	ST expression
MC_TimeStampToPos	Time Stamp to Axis Position Calculation	FB		<pre>MC_TimeStampToPos_instance (   Axis :=parameter,   Enable :=parameter,   TimeStamp :=parameter,   ValueSource :=parameter,   Enabled =&gt;parameter,   Busy =&gt;parameter,   CalcPosition =&gt;parameter,   Error =&gt;parameter,   ErrorID =&gt;parameter );</pre>



## Precautions for Correct Use

- You can use this instruction for the following Units.
  - An axis that is assigned to an NX-series Position Interface Unit.  
The applicable NX Units are as follows: NX-EC0□□□ and NX-ECS□□□.
  - An OMRON 1S-series Servo Drive with built-in EtherCAT communications.
- When you use this instruction for an OMRON 1S-series Servo Drive with built-in EtherCAT communications, you must assign the Object 3211-83 hex (Present Position Time Stamp) to a PDO.



## Version Information

A CPU Unit with unit version 1.06 or later and Sysmac Studio version 1.07 or higher are required to use this instruction.

## Variables

### Input Variables

Name	Meaning	Data type	Valid range	Default	Description
Enable	Enable	BOOL	TRUE or FALSE	FALSE	The instruction is executed while the value of this variable is TRUE.
TimeStamp	Time Stamp	ULINT	Non-negative number	0	Specifies the time stamp for which to calculate the position. A time stamp that is based on the time in a Digital Input Unit, Encoder Input Unit, or OMRON 1S-series Servo Drive with built-in EtherCAT communications that supports time stamp refreshing is specified. The unit is nano-seconds.

Name	Meaning	Data type	Valid range	Default	Description
ValueSource (Reserved)	Input Information	_sMC_SOURCE	---	---	(Reserved)

## Output Variables

Name	Meaning	Data type	Valid range	Description
Enabled	Enable	BOOL	TRUE or FALSE	TRUE when the axis is being controlled.
Busy	Executing	BOOL	TRUE or FALSE	TRUE when the instruction is acknowledged.
CalcPosition	Calculated Position	LREAL	Negative number, positive number, or 0	Contains the position for the specified time stamp. The unit is command units. *1
Error	Error	BOOL	TRUE or FALSE	TRUE while there is an error.
ErrorID	Error Code	WORD	*2	Contains the error code when an error occurs. A value of 16#0000 indicates normal execution.

\*1. Refer to *Unit Conversion Settings* in the *NJ/NX-series CPU Unit Motion Control User's Manual (Cat. No. W507)* for information on command units.

\*2. The upper four digits of the event code give the error code for ErrorID. Refer to the *NJ/NX-series Troubleshooting Manual (Cat. No. W503)* for the event codes.

### ● Output Variable Update Timing

Name	Timing for changing to TRUE	Timing for changing to FALSE
Enabled	When <i>Enable</i> changes to TRUE.	<ul style="list-style-type: none"> <li>After one period when <i>Enable</i> is FALSE.</li> <li>When <i>Error</i> changes to TRUE.</li> </ul>
Busy	When <i>Enable</i> changes to TRUE.	<ul style="list-style-type: none"> <li>When <i>Enable</i> changes to FALSE.</li> <li>When <i>Error</i> changes to TRUE.</li> </ul>
Error	When there is an error in the execution conditions or input parameters for the instruction.	When the error is cleared.

## In-Out Variables

Name	Meaning	Data type	Valid range	Description
Axis	Axis	_sAXIS_REF	---	Specify the axis. *1*2

\*1. Specify a user-defined Axis Variable that was created in the Axis Basic Settings of the Sysmac Studio (default: MC\_Axis\*) or a system-defined axis variable name (\_MC\_AX[\*], \_MC1\_AX[\*], or \_MC2\_AX[\*]). If you use Sysmac Studio version 1.29 or higher, you can specify the system-defined axis variable name for AT specification of a user-defined variable. This will allow you to specify the user-defined variable.

If you use Sysmac Studio version 1.28 or lower, do not specify any user-defined variable created in the variable table.

\*2. Specify the encoder axis that is assigned to the NX-series Encoder Input Unit or the axis for the OMRON 1S-series Servo Drive with built-in EtherCAT communications.

## Function

- The MC\_TimestampToPos instruction calculates the actual current position at the time stamp that is specified by the input variable based on the actual current position and time stamp of the axis.
- For the axis, specify an NX-series Encoder Input Unit.

- If the Count Mode is set to **Linear Mode** in the axis parameters and an overflow or underflow occurs in the calculated position, the calculated value will be the underflow value or the overflow value. In this case, no error will occur.

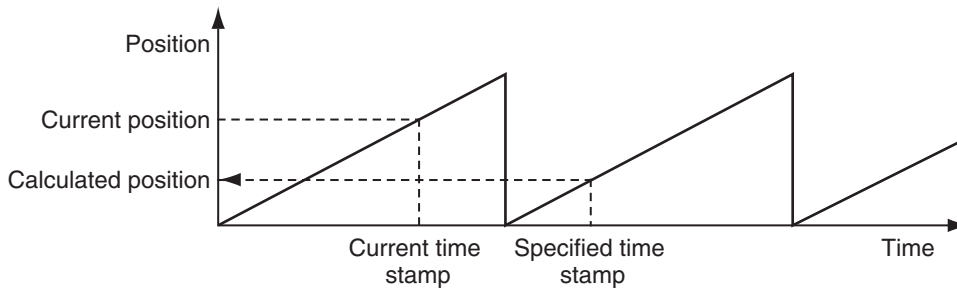

### Precautions for Correct Use

- If you use an NX-series Encoder Input Unit, this instruction requires that time stamping is operating. Time stamping is not possible in the following cases.
  - a) An Encoder Input Unit or Servo Drive that does not support time stamping is used.
  - b) Object 6010 hex (Time Stamp) in the NX-series Encoder Input Unit is not assigned to a PDO.
  - c) The **Enable Distributed Clock** in the EtherCAT Coupler Unit is **Disabled (FreeRun)**.
- If you use an OMRON 1S-series Servo Drive with built-in EtherCAT communications, this instruction is not possible in the following cases.
  - a) Object 3211-83 hex (Present Position Time Stamp) in the OMRON 1S-series Servo Drive with built-in EtherCAT communications is not assigned to a PDO.
  - b) The **Enable Distributed Clock** in the OMRON 1S-series Servo Drive with built-in EtherCAT communications is **Disabled (FreeRun)**.
- An error does not occur for this instruction even if the time stamp is not updated. The position will be calculated, but the result will not be the position for the specified time stamp. Use this instruction only after you confirm in the MC Monitor Table or Watch Tab Page of the Sysmac Studio that the *TimeStamp* member of the Axis Variable is being updated.
- This instruction calculates the position for the specified time stamp based on both the current position and current velocity of the axis. If the axis accelerates or decelerates quickly, the calculation error may increase. Use this instruction when the axis is at a constant velocity. Verify operation sufficiently to confirm safety.
- If you specify an unused axis or if the MC Test Run is in progress, *Busy* will change to TRUE and *Enabled* and *Error* will change to FALSE when *Enable* changes to TRUE.
- Do not create two instances with the same instance name. If you do, unintentional outputs may occur.

## Timing Charts

A timing chart for execution of the MC\_TimestampToPos instruction is shown below.

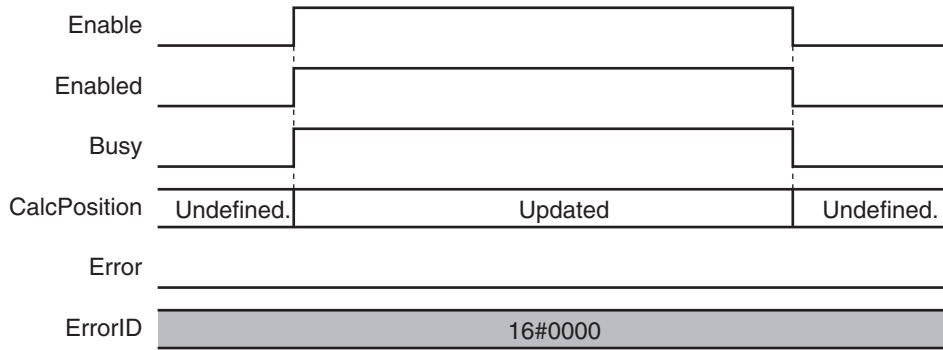

The following timing chart is for when an unused axis is specified or when an MC Test Run in progress.

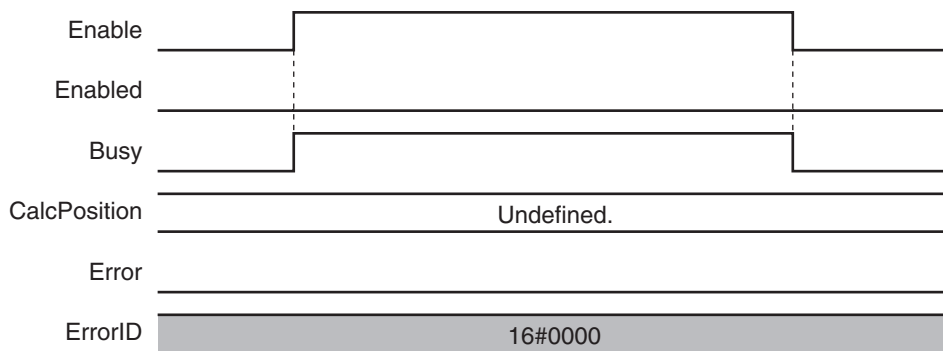

## Re-execution of Motion Control Instructions

You cannot re-execute motion instructions with enable-type inputs.

## Multi-execution of Motion Control Instructions

This instruction is executed independently from other instructions. The restrictions for multi-execution of motion instructions do not apply.

For details on multi-execution of motion control instructions, refer to the *NJ/NX-series CPU Unit Motion Control User's Manual (Cat. No. W507)*.

## Errors

If an error occurs during instruction execution, *Error* will change to TRUE.

You can find out the cause of the error by referring to the value output by *ErrorID* (Error Code).

## ● Timing Chart When Error Occurs

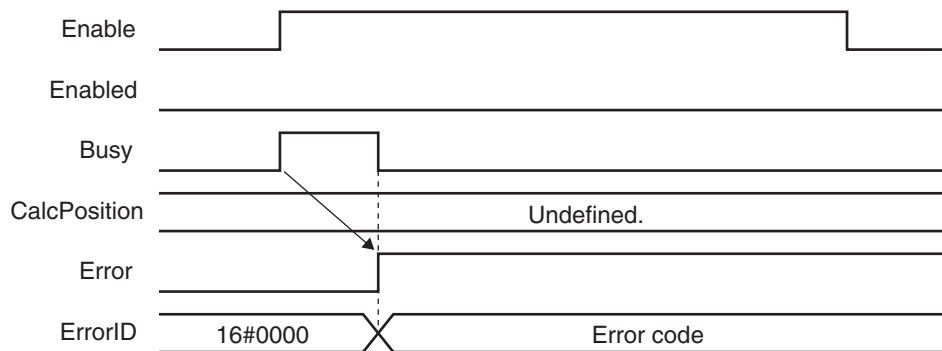

## ● Error Codes

Refer to the *NJ/NX-series Troubleshooting Manual (Cat. No. W503)* for instruction errors.

## Sample Programming

This section shows sample programming that measures the distances between workpieces that move on a conveyor belt.

## Configuration Devices

The following devices are used in this sample programming.

Device	Model number
EtherCAT Coupler Unit	NX-ECC201 (Ver.1.1) <sup>*1</sup>
Pulse Output Unit	NX-PG0122 <sup>*2</sup>
Incremental Encoder Input Unit	NX-EC0122 <sup>*3</sup>
Digital Input Unit	NX-ID3344 <sup>*4</sup>

\*1. The node address is 1 and the device name is E001.

\*2. The NX Unit number is 1 and the device name is N1. It is assigned to axis 1.

\*3. The NX Unit number is 2 and the device name is N2. It is assigned to axis 2.

\*4. The NX Unit number is 3 and the device name is N3.

## Parameter Settings

The minimum settings required for this sample programming are given below.

## ● Axis Parameters

### Axis Types

Axis	Axis type
Axis 1	Servo axis
Axis 2	Encoder axis

### Count Modes



Axis	Count Mode
Axis 1	Rotary Mode
Axis 2	Rotary Mode

### Ring Counters

Axis	Modulo maximum position	Modulo minimum position
Axis 1	360	0
Axis 2	360	0

### Unit of Display

Axis	Unit of Display
Axis 1	degree
Axis 2	degree

## Operation Example

The sensor output turns ON when the sensor detects a workpiece. When the workpiece passes, the sensor output turns OFF. When the sensor detects the next workpiece, the sensor output turns ON again.

The position of the encoder input is calculated based on the time stamp when the sensor output turns ON. The difference between two positions is the distance between the workpieces.

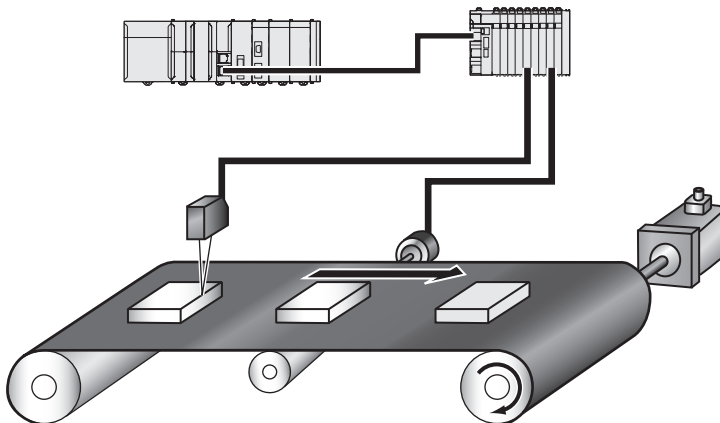

## Ladder Diagram

### ● Main Variables

Name	Data type	Default	Comment
MC_Axis000	_sAXIS_REF	---	Axis Variable for axis 1.
MC_Axis001	_sAXIS_REF	---	Axis Variable for axis 2.
N3_Input_Bit_00	BOOL	---	Device variable
N3_Input_Bit_00_Time_Stamp	ULINT	---	Device variable
Position	ARRAY[0..1] OF LREAL	---	Stores the calculated positions.

Name	Data type	Default	Comment
Count	ARRAY[0..1] OF ULINT	---	Stores the number of rotations.
FirstPoint	UINT	---	A variable that is used for processing.
LastPoint	UINT	---	A variable that is used for processing.
Distance	LREAL	---	The distance between workpieces.

#### ● Sample Programming

If *StartPg* is TRUE, check that the Servo Drive for axis 1 is ready.

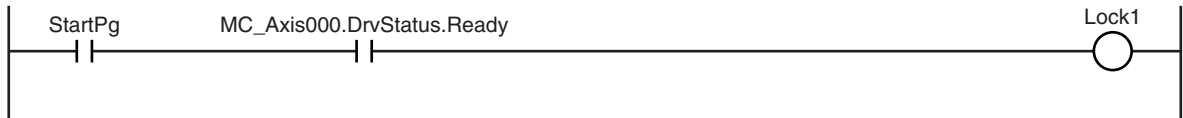

If the Servo Drive for axis 1 is ready, the Servo is turned ON.

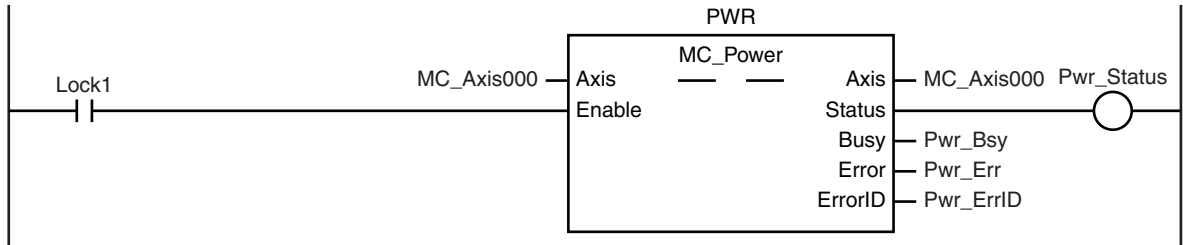

If a minor fault level error occurs for the axis composition, the error handler for the device (FaultHandler) is executed.  
Program the FaultHandler according to the device.

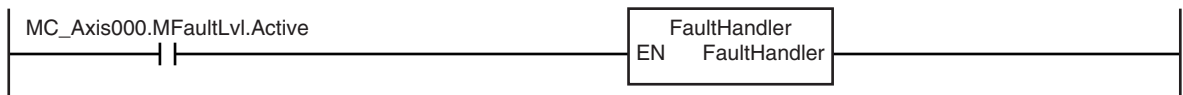

If the Servo is ON for axis 1 and home is not defined, the Home instruction is executed to define home.

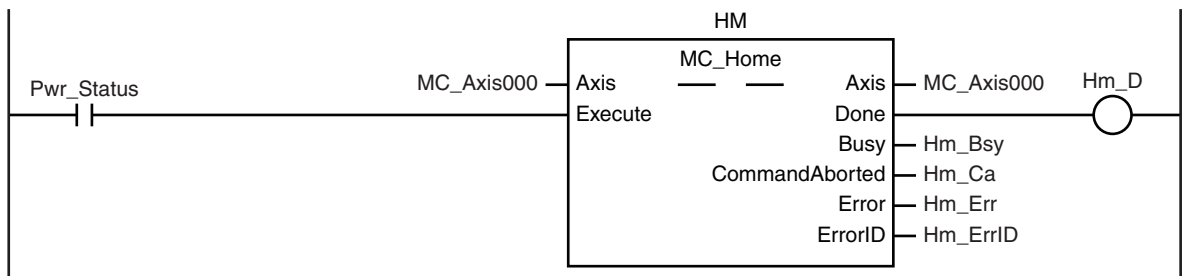

The parameters are set for the MC\_MoveVelocity (Velocity Control) instruction.

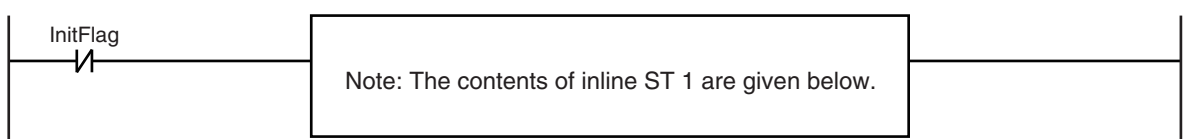

The MC\_MoveVelocity (Velocity Control) instruction is executed if home is defined for axis 1.

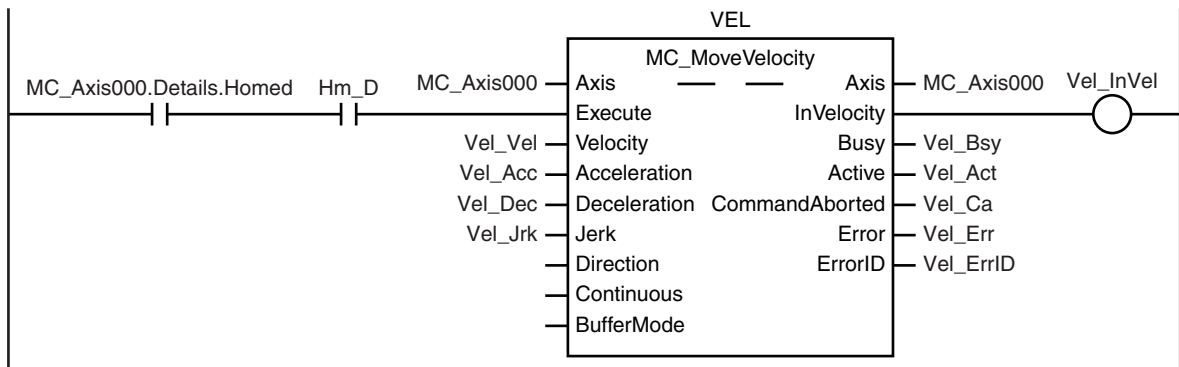

After the MC\_MoveVelocity (Velocity Control) instruction is executed for axis 1, the MC\_TimeStampToPos (Time Stamp to Axis Position Calculation) instruction is executed for axis 2.

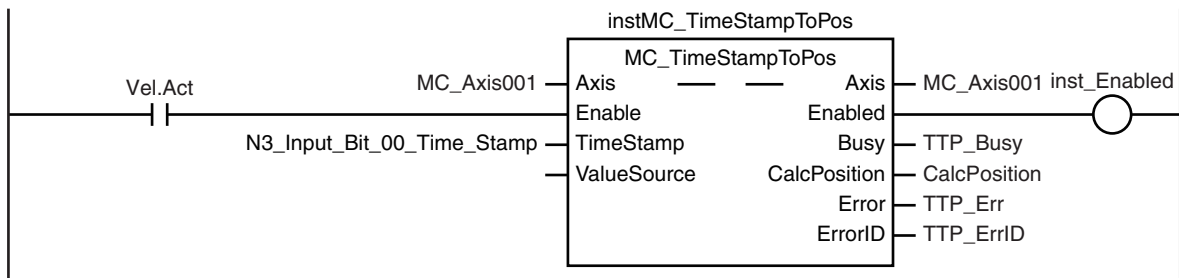

The number of rotations of the encoder axis is counted. (If the current value is less than the previous value, it is assumed that the modulo maximum position has been exceeded.)

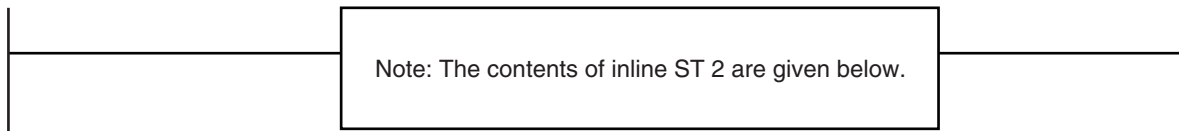

CalcPosition (calculated position) is obtained when the sensor output turns ON. (The position is saved alternately in Position[0] and Position[1].)

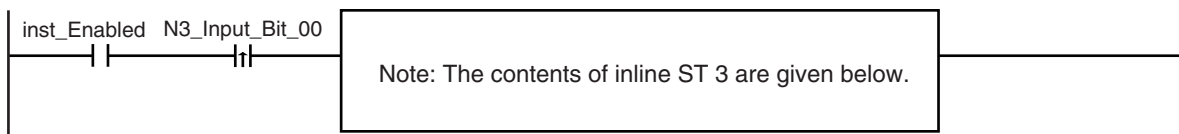

After two workpieces are detected, the distance between the workpieces is calculated.

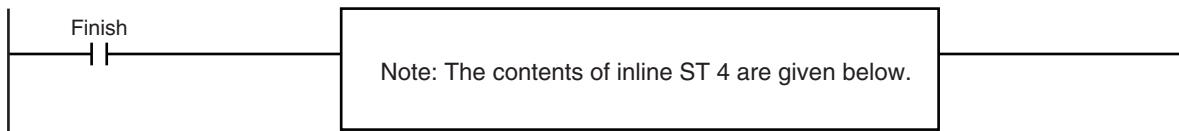

**Contents of Inline ST 1**

```
//MC_MoveVelocity parameters
Vel_Vel := LREAL#1000.0;
Vel_Acc := LREAL#0.0;
Vel_Dec := LREAL#0.0;
Vel_Jrk := LREAL#1000.0;
InitFlag := BOOL#TRUE;
```

**Contents of Inline ST 2**

```

IF MC_Axis001.Act.Pos < PreAxis001ActPos THEN
    Inc(RotaryCount);
END_IF;
PreAxis001ActPos := MC_Axis001.Act.Pos;

```

**Contents of Inline ST 3**

```

IF Index < UINT#2 THEN
    Position[Index] := CalcPosition;
    Count[Index] := RotaryCount;
    Index := Index + UINT#1;
END_IF;
IF Index >= UINT#2 THEN
    Finish := BOOL#TRUE;
    Index := UINT#0;
END_IF;

```

**Contents of Inline ST 4**

```

//First comparison: Workpiece 1=Position[0] and workpiece 2=Position[1]
//Second comparison: Workpiece 2=Position[1] and workpiece 3=Position[0]
//Third comparison: Workpiece 3=Position[0] and workpiece 4=Position[1]

FirstPoint := (Index+UINT#1) MOD UINT#2;
LastPoint :=Index;
DiffCount := Count[1] - Count[0];
Distance := (ABS(DiffCount) -LINT#1)* 360.0 +
            (360.0 + Position[FirstPoint] - Position[LastPoint]);

```

## Structured Text (ST)

### ● Main Variables

Name	Data type	Default	Comment
MC_Axis000	_sAXIS_REF	---	Axis Variable for axis 1.
MC_Axis001	_sAXIS_REF	---	Axis Variable for axis 2.
N3_Input_Bit_00	BOOL	---	Device variable
N3_Input_Bit_00_Time_Stamp	ULINT	---	Device variable
Hm_Ex	BOOL	FALSE	The HM instance of MC_Home is executed when this variable changes to TRUE.
Vel_Ex	BOOL	FALSE	The VEL instance of MC_Move-Velocity is executed when this variable changes to TRUE.
PreN3InputBit00	BOOL	---	The previous value of the N3_Input_Bit_00 device variable.
Position	ARRAY[0..1] OF LREAL	---	Stores the calculated positions.
Count	ARRAY[0..1] OF ULINT	---	Stores the number of rotations.

Name	Data type	Default	Comment
FirstPoint	UINT	---	A variable that is used for processing.
LastPoint	UINT	---	A variable that is used for processing.
Distance	LREAL	---	The distance between workpieces.

### ● Sample Programming

```
//Processing when input parameters are not set
IF InitFlag=FALSE THEN

    //MC_MoveVelocity parameters
    Vel_Vel := LREAL#1000.0;
    Vel_Acc := LREAL#0.0;
    Vel_Dec := LREAL#0.0;
    Vel_Jrk := LREAL#1000.0;

    //InitFlag is changed to TRUE after input parameters are set.
    InitFlag:=TRUE;

END_IF;

//If StartPg is TRUE and the Servo Drive is ready, the Servo for axis 1 is turned ON.
//If the Servo Drive is not ready, the Servo is turned OFF.
IF (StartPg=TRUE)
    AND (MC_Axis000.DrvStatus.Ready=TRUE) THEN
    Pwr_En:=TRUE;
ELSE
    Pwr_En:=FALSE;
END_IF;

//If a minor fault level error occurs for axis 1, the error handler for the device
(FaultHandler) is executed.
//Program the FaultHandler according to the device.
IF MC_Axis000.MFaultLvl.Active=TRUE THEN
    FaultHandler();
END_IF;

//If the Servo is ON and home is not defined, the Home instruction is executed.
IF (Pwr_Status=TRUE) THEN
    Hm_Ex:=TRUE;
END_IF;

//After home is defined, MC_MoveVelocity is executed.
IF MC_Axis000.Details.Homed=TRUE AND Hm_D=TRUE THEN
```

```

    Vel_Ex:=TRUE;
END_IF;

//The number of rotations of the encoder axis is counted.
//(If the current value is less than the previous value, it is assumed that the mod
ulo maximum position has been exceeded.)
IF MC_Axis001.Act.Pos<PreAxis001ActPos THEN
    Inc(RotaryCount);
END_IF;
PreAxis001ActPos := MC_Axis001.Act.Pos;

//MC_TimeStampToPos
instMC_TimeStampToPos(
    Axis := MC_Axis001,
    Enable := Vel_Ex,
    TimeStamp := TimeStamp,
    Enabled => inst_Enabled,
    Busy => TSTP_Busy,
    CalcPosition => CalcPosition,
    Error => TSTP_Error,
    ErrorID => TSTP_ErrorID );

//CalcPosition (calculated position) is obtained when the sensor output turns ON.
//(The position is saved alternately in Position[0] and Position[1].
IF inst_Enabled THEN
    IF PreN3InputBit00=FALSE AND N3_Input_Bit_00=TRUE THEN
        IF Index < UINT#2 THEN
            Position[Index] := CalcPosition;
            Count[Index] := RotaryCount;
            Index := Index + UINT#1;
        END_IF;
        IF Index >= UINT#2 THEN
            Finish := BOOL#TRUE;
            Index := UINT#0;
        END_IF;
    END_IF;
PreN3InputBit00 := N3_Input_Bit_00;

//After two workpieces are detected, the distance between the workpieces is calcula
ted.
//First comparison: Workpiece 1=Position[0] and workpiece 2=Position[1]
//Second comparison: Workpiece 2=Position[1] and workpiece 3=Position[0]
//Third comparison: Workpiece 3=Position[0] and workpiece 4=Position[1]
//...
IF Finish THEN
    FirstPoint := (Index+UINT#1) MOD UINT#2;

```

```

    LastPoint := Index;
    DiffCount := Count[1] - Count[0];
    Distance := (ABS( DiffCount) -LINT#1)* 360.0 +
        (360.0 + Position[FirstPoint] -Position[LastPoint]);
END_IF;

//MC_Power
PWR(
    Axis := MC_Axis000,
    Enable := Pwr_En,
    Status => Pwr_Status,
    Busy => Pwr_Bsy,
    Error => Pwr_Err,
    ErrorID => Pwr_ErrID
);

//MC_Home
HM(
    Axis := MC_Axis000,
    Execute := Hm_Ex,
    Done => Hm_D,
    Busy => Hm_Bsy,
    CommandAborted => Hm_Ca,
    Error => Hm_Err,
    ErrorID => Hm_ErrID
);

//MC_MoveVelocity
VEL(
    Axis := MC_Axis000,
    Execute := Vel_Ex,
    Velocity := Vel_Vel,
    Acceleration := Vel_Acc,
    Deceleration := Vel_Dec,
    Jerk := Vel_Jrk,
    InVelocity => Vel_InVel,
    Busy => Vel_Bsy,
    Active => Vel_Act,
    CommandAborted => Vel_Ca,
    Error => Vel_Err,
    ErrorID => Vel_ErrID
);

```

# MC\_PeriodicSyncVariables

The MC\_PeriodicSyncVariables instruction periodically synchronizes Axes Variables between tasks.

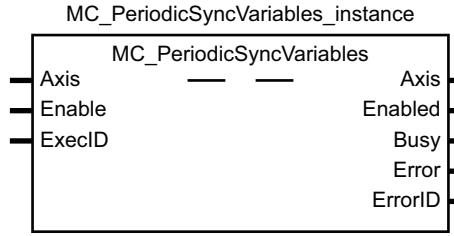
Instruction	Name	FB/ FUN	Graphic expression	ST expression
MC_PeriodicSyncVariables	Periodic Axis Variable Synchronization between Tasks	FB		<pre>MC_PeriodicSyncVariables_in- stance ( Axis :=parameter, Enable :=parameter, ExecID :=parameter, Enabled =&gt;parameter, Busy =&gt;parameter, Error =&gt;parameter, ErrorID =&gt;parameter );</pre>



## Precautions for Correct Use

You cannot use this instruction for an NX502 CPU Unit, NX102 CPU Unit, NX1P2 CPU Unit, or NJ-series CPU Unit.

## Variables

### Input Variables

Name	Meaning	Data type	Valid range	De- fault	Description
Enable	Enable	BOOL	TRUE or FALSE	FALSE	The instruction is executed when the value of this variable changes to TRUE.
ExecID	Execution ID	UINT	2	2	Gives the ID of the task with which the value of the variable is synchronized. 2: Priority-5 periodic task

### Output Variables

Name	Meaning	Data type	Valid range	Description
Enabled	Enabled	BOOL	TRUE or FALSE	TRUE when the axis is being controlled.
Busy	Executing	BOOL	TRUE or FALSE	TRUE when the instruction is acknowledged.
Error	Error	BOOL	TRUE or FALSE	TRUE while there is an error.
ErrorID	Error Code	WORD	*1	Contains the error code when an error occurs. A value of 16#0000 indicates normal execution.

\*1. The upper four digits of the event code give the error code for ErrorID. Refer to the *NJ/NX-series Troubleshooting Manual (Cat. No. W503)* for the event codes.



## ● Output Variable Update Timing

Name	Timing for changing to TRUE	Timing for changing to FALSE
Enabled	When <i>Enable</i> changes to TRUE.	<ul style="list-style-type: none"> <li>• After one period when <i>Enable</i> is FALSE.</li> <li>• When <i>Error</i> changes to TRUE.</li> </ul>
Busy	When <i>Enable</i> changes to TRUE.	<ul style="list-style-type: none"> <li>• When <i>Enable</i> changes to FALSE.</li> <li>• When <i>Error</i> changes to TRUE.</li> </ul>
Error	When there is an error in the execution conditions or input parameters for the instruction.	When the error is cleared.

## In-Out Variables

Name	Meaning	Data type	Valid range	Description
Axis	Axis	_sAXIS_REF	---	Specifies the axis. *1

- \*1. Specify a user-defined Axis Variable that was created in the Axis Basic Settings of the Sysmac Studio (default: MC\_Axis\*) or a system-defined axis variable name (\_MC\_AX[\*], \_MC1\_AX[\*], or \_MC2\_AX[\*]).  
If you use Sysmac Studio version 1.29 or higher, you can specify the system-defined axis variable name for AT specification of a user-defined variable. This will allow you to specify the user-defined variable.  
If you use Sysmac Studio version 1.28 or lower, do not specify any user-defined variable created in the variable table.

## Function

- While *Enable* is TRUE, an Axis Variable is periodically synchronized between the primary periodic task and a priority-5 periodic task.
- The synchronized Axis Variable is output to the Axis Variable system-defined variable in the specified task.



### Precautions for Correct Use

- This instruction supports variable synchronization only from the primary periodic task to the priority-5 periodic task.
- Even if the value of *ExecID* (Execution ID) specifies the task where that axis is assigned, an error does not occur and *Busy* remains TRUE.



### Additional Information

If you declare an external variable in the user program for an Axis Variable of an axis that is controlled in a different task, you cannot be sure of the update timing of the accessed Axis Variable, which will depend on when execution of the user program started.

Always use the MC\_PeriodicSyncVariables (Periodic Axis Variable Synchronization between Tasks) instruction when controls are performed in different tasks for applications that have master-slave relationships between the controlled axes, such as those for electronic cams.

## Instruction Details

This section describes the instruction in detail.

● **Timing of Synchronization**

You can access values in the Axis Variable of an axis that is controlled in the user program for the primary periodic task from the user program for the priority-5 periodic task.

Values are never written to the Axis Variable of an axis in the primary periodic task while the program for the priority-5 periodic task is being executed.

The user program for the priority-5 periodic task uses the execution results from the primary periodic task from just prior to when the start of the primary periodic task and the start of the priority-5 periodic task coincided.

The following figure shows the timing of applying the values in an Axis Variable in the primary periodic task to the priority-5 periodic task.

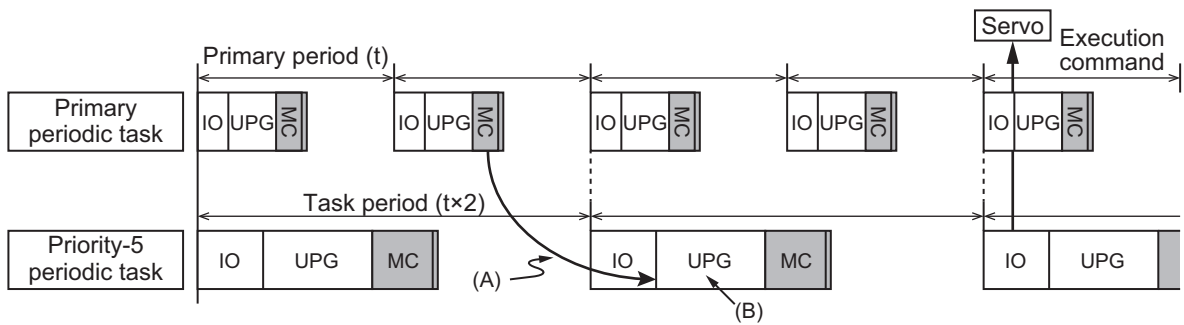

Abbreviation	Description
(A)	Axis Variable updated. Regardless of where the user program execution for the priority-5 periodic task starts, the execution results from the primary periodic task from just prior to when the start of the task periods coincided are used.
(B)	The values in the Axis Variable will not be overwritten during the user program execution.

This is true even if the task periods are the same.

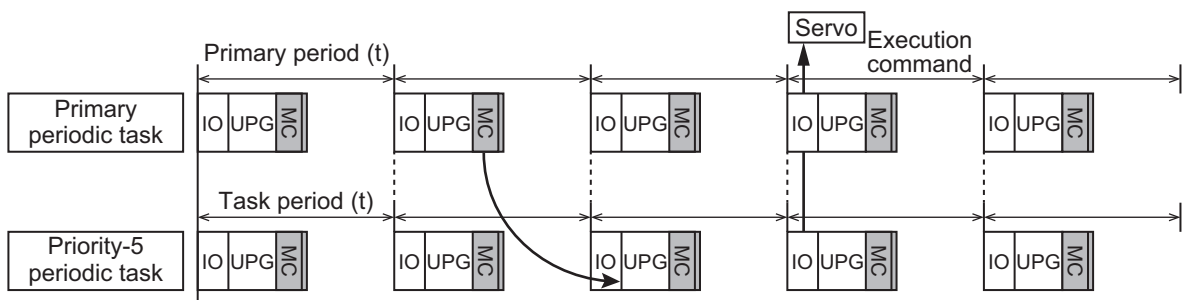



**Additional Information**

If a task period is exceeded, the execution results from just prior to when the start of the task periods coincided are not used, rather, the execution results from the period before that period are used.

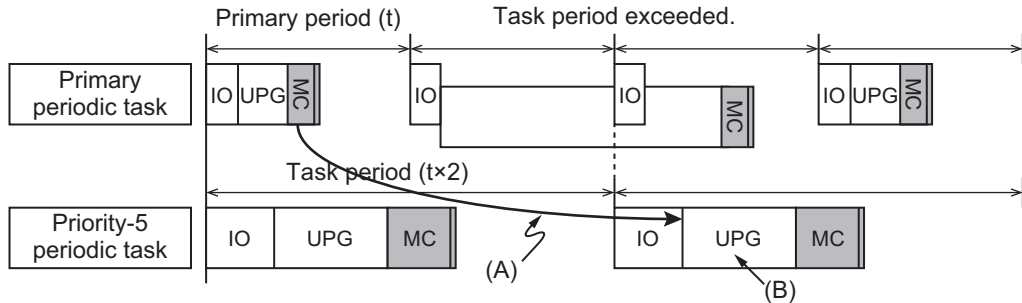

Ab- brevi- ation	Description
(A)	Axis Variable updated. If the task period is exceeded, the values from one more period before that period are applied.
(B)	The values in the Axis Variable will not be overwritten during the user program execution.

● **Variable Output Area**

The synchronized Axis Variable is output to the Axis Variable system-defined variable in the specified task.

For example, if the **Motion Control** axis parameters are set as shown below, the Axis Variable system-defined variables shown in the following figure are updated.

Axis number	Motion control parameters in assigned task
Axis 0	Primary periodic task
Axis 1	Primary periodic task
Axis 2	Priority-5 periodic task
Axis 3	Primary periodic task

Primary Periodic Task  
\_MC1\_AX[0-255]

[0]
[1]
Reserved
[3]

Priority-5 Periodic Task  
\_MC2\_AX[0-255]

Reserved
Reserved
[2]
Reserved

**Note** The parameters that are labeled Reserved will have the default settings except for the basic settings.

If you set *Axis* to axis 1 and *ExecID* (Execution ID) to 10#2 and execute the MC\_PeriodicSyncVariables (Periodic Axis Variable Synchronization between Tasks) instruction, the area for \_MC2\_Ax[1] is updated.

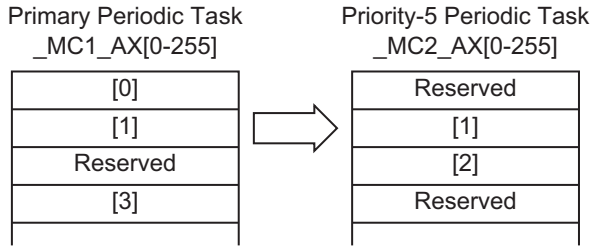

### Re-execution of Motion Control Instructions

You cannot re-execute motion instructions with enable-type inputs.

### Multi-execution of Motion Control Instructions

For details on multi-execution of motion control instructions, refer to the *NJ/NX-series CPU Unit Motion Control User's Manual (Cat. No. W507)*.

#### ● Multi-execution of MC\_PeriodicSyncVariables Instructions

If you execute a different instance of the MC\_PeriodicSyncVariables (Periodic Axis Variable Synchronization between Tasks) instruction during execution of the MC\_PeriodicSyncVariables (Periodic Axis Variable Synchronization between Tasks) instruction, both instances are executed.

### Errors

If an error occurs during instruction execution, *Error* will change to TRUE.

You can find out the cause of the error by referring to the value output by *ErrorID* (Error Code).

#### ● Timing Chart When Error Occurs

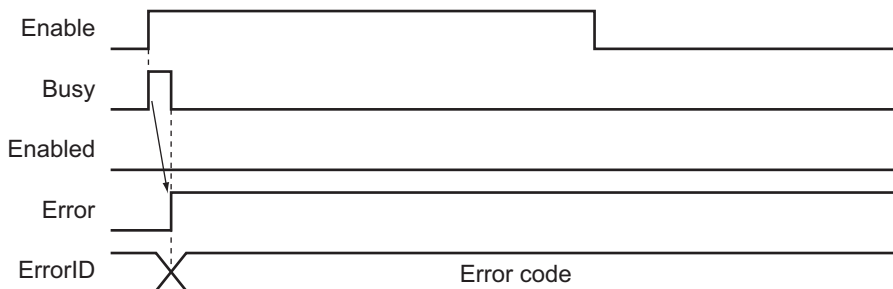

#### ● Error Codes

Refer to the *NJ/NX-series Troubleshooting Manual (Cat. No. W503)* for instruction errors.

### Sample Programming

In this sample, axis 1 is the master axis. Axis 2 is a slave axis that requires high-speed, high-precision control. It is assigned to the primary periodic task. Axis 3 is a slave axis that does not require

precision. It is assigned to a priority-5 periodic task. The master axis (axis 1) is assigned to the primary periodic task.

● **Physical Axis Configuration**

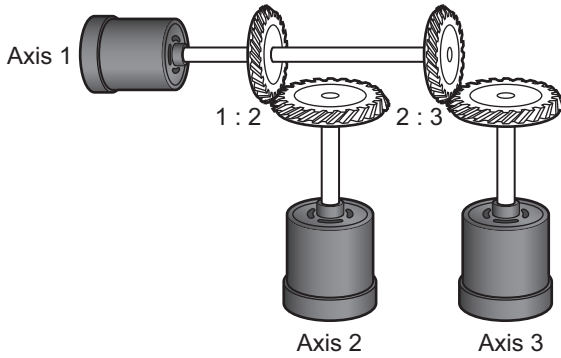

● **Logical Axis Configuration**

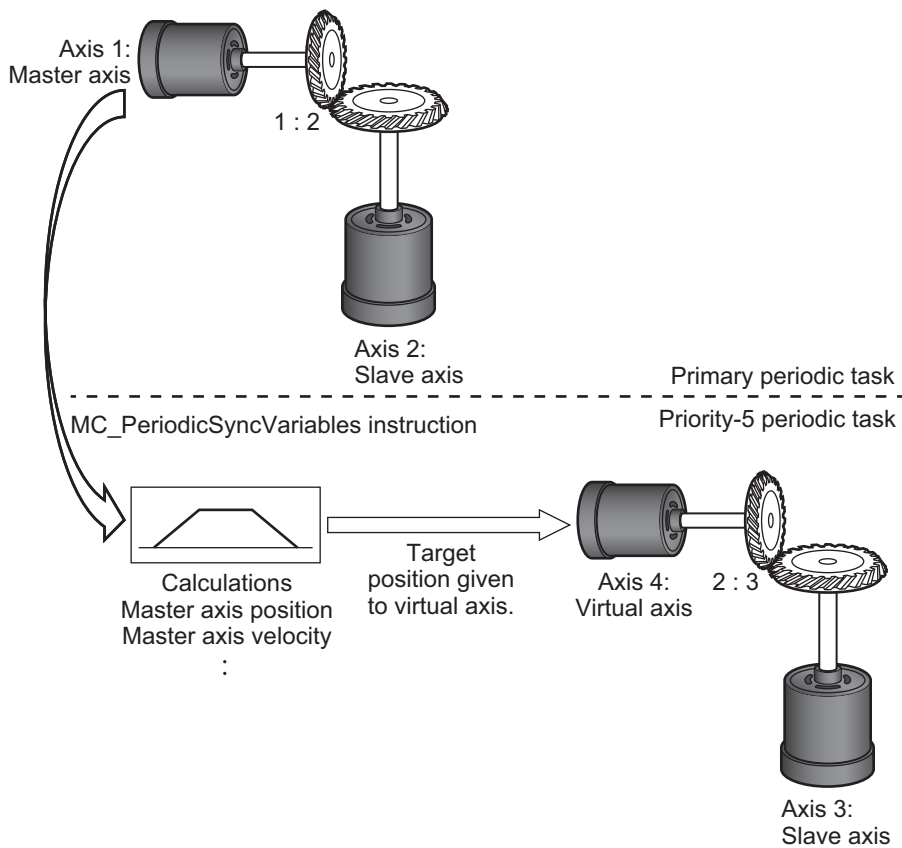

Programming is placed in both the primary periodic task and priority-5 periodic task to achieve the operation for the above application.

## Programming in the Primary Periodic Task

- The MC\_PeriodicSyncVariables (Periodic Axis Variable Synchronization between Tasks) instruction is executed in the primary periodic task for the master axis (Primary\_MasterAxis) assigned to the primary periodic task.
- By executing the MC\_PeriodicSyncVariables (Periodic Axis Variable Synchronization between Tasks) instruction, the Axis Variable in the master axis is periodically updated in the priority-5 periodic task.
- The main variable that is used in programming is given below.

Name	Data type	Comment
Primary_MasterAxis	_sAXIS_REF	Master axis (axis 1). The Axis Variable is _MC1_AX[0]. It is assigned to the primary periodic task.* <sup>1</sup>

\*1. Always assign the master axis to the primary periodic task.

### Ladder Diagram

The ladder diagram programming in the primary periodic task is given below.

The MC\_PeriodicSyncVariables (Periodic Axis Variable Synchronization between Tasks) instruction is executed in the primary periodic task.

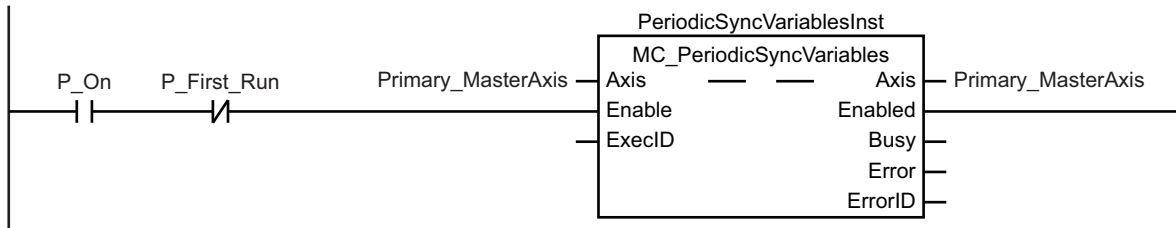

## Programming in the Priority-5 Periodic Task

- By executing the MC\_PeriodicSyncVariables (Periodic Axis Variable Synchronization between Tasks) instruction, you can access the Axis Variable for the master axis (Primary\_MasterAxis) that is updated each period, in the priority-5 periodic task.
- Based on the information for the master axis, the MC\_SyncMoveAbsolute (Axes Group Cyclic Synchronous Absolute Positioning) instruction is executed for the virtual master axis (Secondary\_VirtualMasterAxis) assigned to the priority-5 periodic task to follow the master axis.
- The virtual master axis (Secondary\_VirtualMasterAxis) is specified as the master axis of the slave axis (Secondary\_SlaveAxis).
- By executing the MC\_GearIn (Start Gear Operation) instruction or other synchronized control instructions, you can achieve synchronized control between axes assigned to different task periods.
- The main variables that are used in programming are given below.

Variable	Data type	Comment
Secondary_VirtualMasterAxis	_sAXIS_REF	Virtual axis. Assigned to priority-5 periodic task.
Secondary_SlaveAxis	_sAXIS_REF	Slave axis (axis 3). Assigned to priority-5 periodic task.

Variable	Data type	Comment
Primary_MasterAxis *1	_sAXIS_REF	Master axis. The Axis Variable is _MC2_AX[4]. The Axis Variable is synchronized every period by execution of the MC_PeriodicSyncVariables (Periodic Axis Variable Synchronization between Tasks) instruction.
PhaseShift	LREAL	Phase shift amount
VirtualMasterAxisTargetPosition	LREAL	Target position of the virtual master axis for each task period
SyncExecute	BOOL	Synchronized control start signal for slave axis

\*1. In this sample, the *Primary\_MasterAxis* internal variable is defined with the same name as the master axis in the primary periodic task.

### Ladder Diagram

The ladder diagram programming in the priority-5 periodic task is given below.

The current position and phase shift amount (*PhaseShift*) of *Primary\_MasterAxis* are added to obtain the command position (*VirtualMasterAxisTargetPosition*) for *Secondary\_VirtualMasterAxis*. The MC\_SyncMoveAbsolute (Cyclic Synchronous Absolute Positioning) instruction is used so that *Secondary\_VirtualMasterAxis* always follows *Primary\_MasterAxis*.

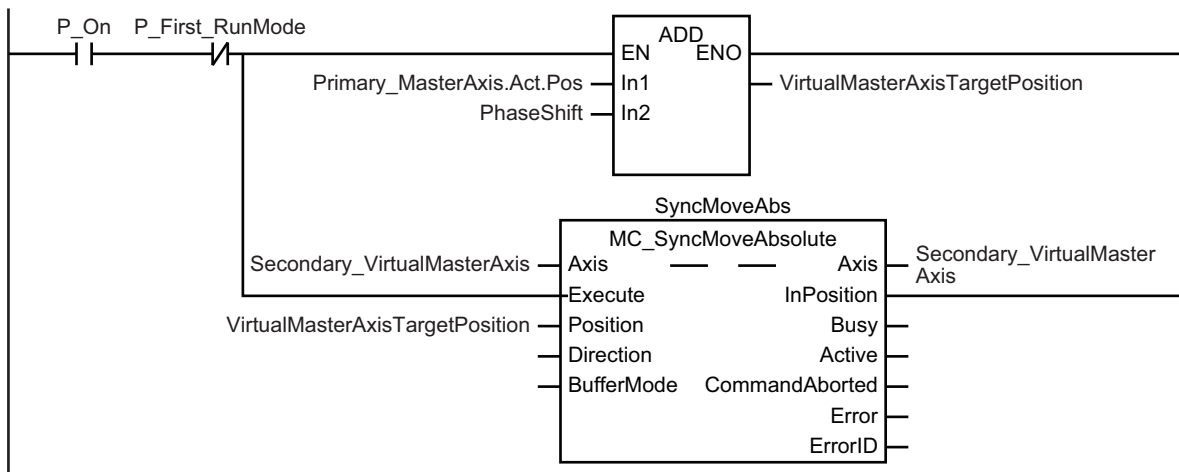

A synchronized control instruction is executed for *Secondary\_SlaveAxis* with *Secondary\_VirtualMasterAxis* as the virtual master axis.

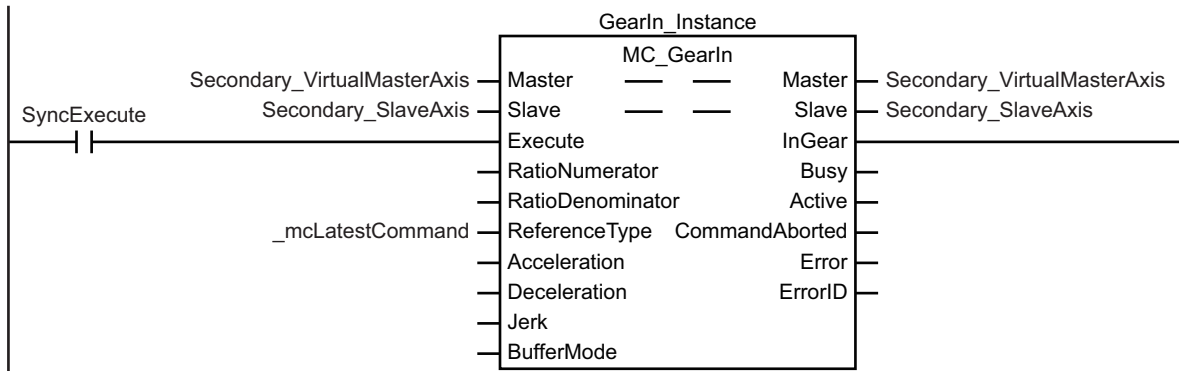

# MC\_SyncOffsetPosition

The MC\_SyncOffsetPosition cyclically adds the specified position offset to the command current position of the slave axis in synchronized control, and outputs the result.

Instruction	Name	FB/ FUN	Graphic expression	ST expression
MC_SyncOffsetPosition	Cyclic Synchronous Position Offset Compensation	FB		<pre>MC_SyncOffsetPosition_instance (   Axis :=parameter,   Execute :=parameter,   OffsetPosition :=parameter,   BufferMode :=parameter,   MoveMode :=parameter,   OutputtedOffsetPosition =&gt;parameter,   Busy =&gt;parameter,   Active =&gt;parameter,   CommandAborted =&gt;parameter,   Error =&gt;parameter,   ErrorID =&gt;parameter );</pre>



## Version Information

A CPU Unit with unit version 1.10 or later and Sysmac Studio version 1.12 or higher are required to use this instruction.

## Variables

### Input Variables

Name	Meaning	Data type	Valid range	Default	Description
Execute	Execute	BOOL	TRUE or FALSE	FALSE	The instruction is executed when the value of this variable changes to TRUE.
OffsetPosition	Position Offset	LREAL	Negative number, positive number, or 0	0	Specify the position offset to add to the command current position. The unit is command units. *1
BufferMode	Buffer Mode Selection	_eMC_BUFFER_MODE	0: _mcAborting	0*2	Specify the behavior when executing more than one motion instruction. 0: Aborting
MoveMode	Travel Mode	_eMC_MOVE_MODE	1: _mcRelative	0*2	Select the travel method. 1: Relative positioning

\*1. Refer to *Unit Conversion Settings* in the *NJ/NX-series CPU Unit Motion Control User's Manual (Cat. No. W507)* for information on command units.

\*2. The default value for an enumeration variable is actually not the number, but the enumerator.



## Output Variables

Name	Meaning	Data type	Valid range	Description
OutputtedOffset-Position	Position Offset Output Value	LREAL	Negative number, positive number, or 0	Contains the position offset that was added to the command current position. The value is updated when <i>Active</i> is TRUE. Updating is stopped and the value is retained when <i>CommandAborted</i> or <i>Error</i> is TRUE.
Busy	Executing	BOOL	TRUE or FALSE	TRUE when the instruction is acknowledged.
Active	Controlling	BOOL	TRUE or FALSE	TRUE while the axis is being controlled.
CommandAborted	Instruction Aborted	BOOL	TRUE or FALSE	TRUE when the instruction is aborted.
Error	Error	BOOL	TRUE or FALSE	TRUE while there is an error.
ErrorID	Error Code	WORD	*1	Contains the error code when an error occurs. A value of 16#0000 indicates normal execution.

\*1. The upper four digits of the event code give the error code for ErrorID. Refer to the *NJ/NX-series Troubleshooting Manual (Cat. No. W503)* for the event codes.

### ● Output Variable Update Timing

Name	Timing for changing to TRUE	Timing for changing to FALSE
Busy	When <i>Execute</i> changes to TRUE.	<ul style="list-style-type: none"> <li>When <i>Error</i> changes to TRUE.</li> <li>When <i>CommandAborted</i> changes to TRUE.</li> </ul>
Active	When the instruction is started.	<ul style="list-style-type: none"> <li>When <i>Error</i> changes to TRUE.</li> <li>When <i>CommandAborted</i> changes to TRUE.</li> </ul>
CommandAborted	<ul style="list-style-type: none"> <li>When execution of the synchronized control instruction is stopped.</li> <li>When this instruction is aborted because another motion control instruction was executed during execution of this instruction.</li> <li>When this instruction is canceled due to an error in another instruction.</li> <li>When this instruction is executed while there is an axis error.</li> <li>When you start this instruction during <i>MC_Stop</i> instruction execution.</li> </ul>	<ul style="list-style-type: none"> <li>When <i>Execute</i> is TRUE and changes to FALSE.</li> <li>After one period when <i>Execute</i> is FALSE.</li> </ul>
Error	When there is an error in the execution conditions or input parameters for the instruction.	When the error is cleared.

## In-Out Variables

Name	Meaning	Data type	Valid range	Description
Axis	Axis	_sAXIS_REF	---	Specify the axis. *1*2

\*1. Specify a user-defined Axis Variable that was created in the Axis Basic Settings of the Sysmac Studio (default: *MC\_Axis\**) or a system-defined axis variable name (*\_MC\_AX[\*]*, *\_MC1\_AX[\*]*, or *\_MC2\_AX[\*]*). If you use Sysmac Studio version 1.29 or higher, you can specify the system-defined axis variable name for AT specification of a user-defined variable. This will allow you to specify the user-defined variable. If you use Sysmac Studio version 1.28 or lower, do not specify any user-defined variable created in the variable table.

- \*2. Specify the encoder axis that is assigned to the NX-series Encoder Input Unit or the axis for the OMRON 1S-series Servo Drive with built-in EtherCAT communications.

## Function

- The MC\_SyncOffsetPosition instruction adds an offset that is calculated based on the value of the *OffsetPosition* (Position Offset) input variable to the command current position and outputs the result to the Servo Drive.
- You can change the value of the *OffsetPosition* (Position Offset) input variable while the *Active* (Controlling) output variable is TRUE.
- The starting point for this instruction is used as the starting point for *OffsetPosition* (Position Offset) as long as *Active* (Controlling) of this instruction is TRUE. Refer to *Repeatedly Starting and Stopping this Instruction* on page 3-467 for details.

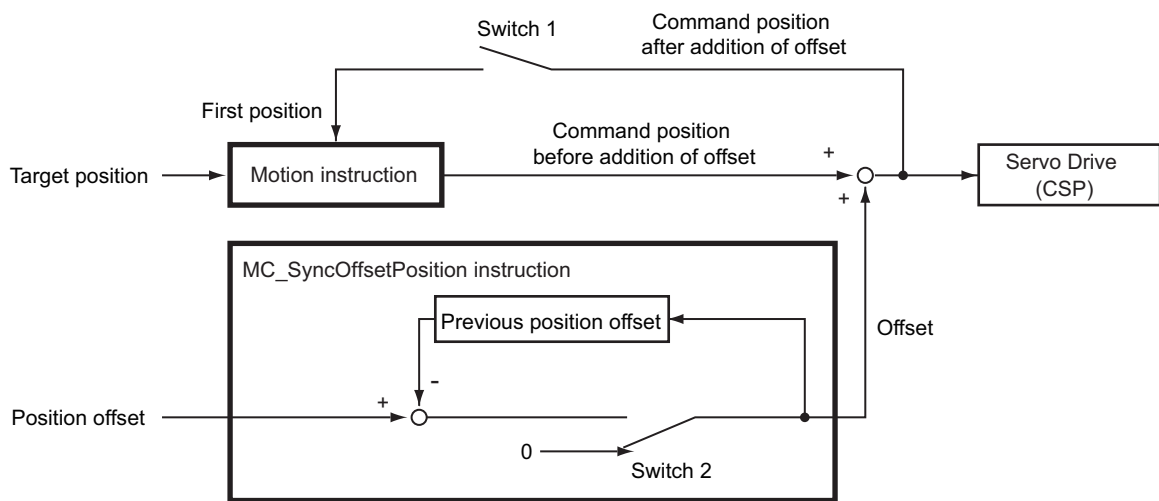

- Switch 1 is turned ON only once when *Execute* of the motion instruction is changed to TRUE.
  - Switch 2 is ON while *Active* (Controlling) of the MC\_SyncOffsetPosition instruction is TRUE.
  - When switch 2 is OFF, the offset that is added to the command position is 0.
- You can execute this instruction only for a slave axis that is currently in synchronized control.
  - After execution of this instruction is started, *CommandAborted* (Instruction Aborted) changes to TRUE after *Done*, *CommandAborted* (Instruction Aborted), or *Error* of the target synchronized control instruction changes to TRUE.
  - If *CommandAborted* (Instruction Aborted) or *Error* of this instruction changes to TRUE, the offset that was previously added to the command position is retained.
  - The following timing chart shows execution of this instruction while execution of the MC\_GearIn (Start Gear Operation) instruction is in progress in the primary periodic task and then *CommandAborted* (Instruction Aborted) of the MC\_GearIn (Start Gear Operation) instruction changes to TRUE.

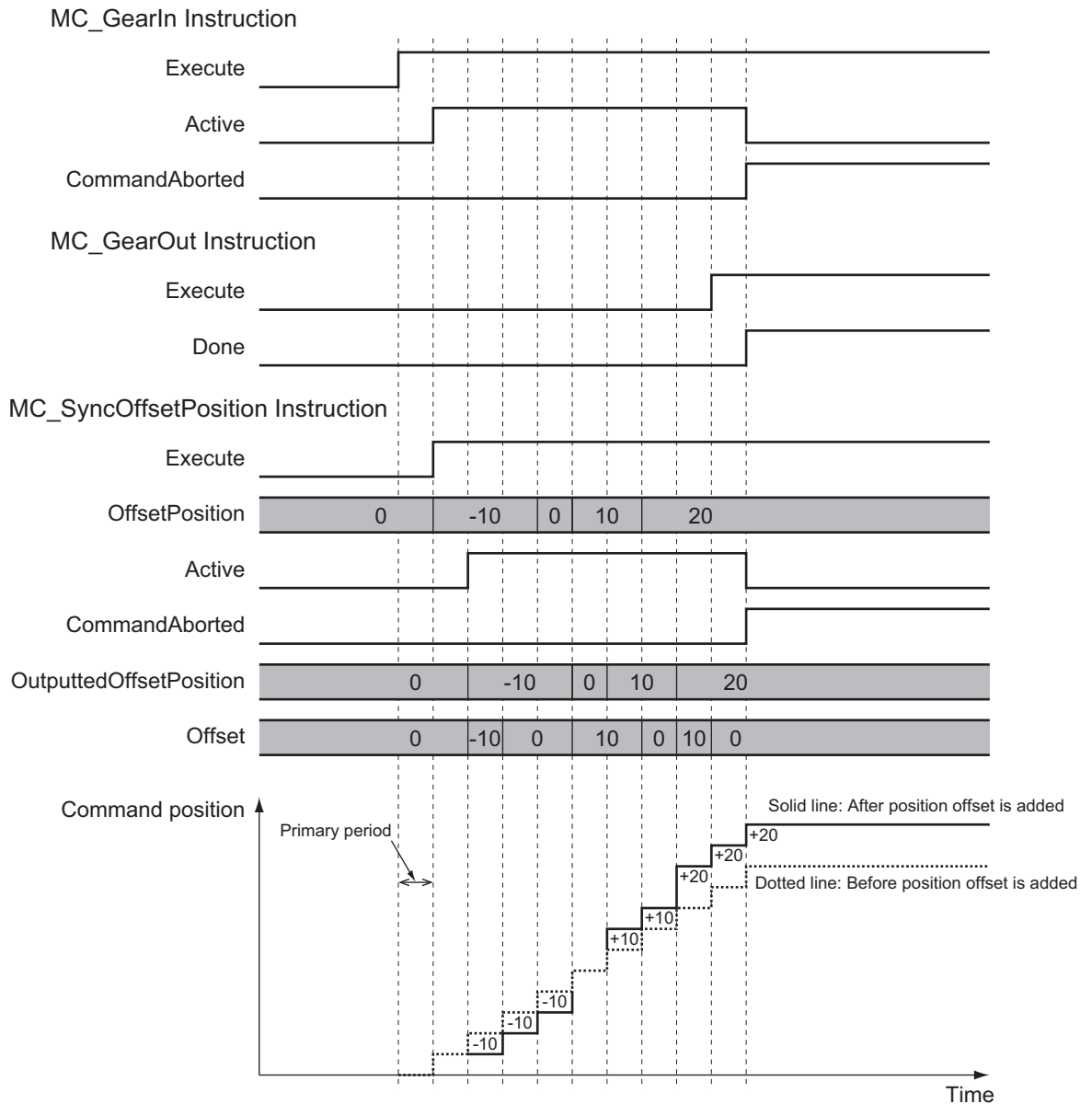

● Repeatedly Starting and Stopping this Instruction

If you execute this instruction again after it is aborted, 0 is used as the starting point for the *OffsetPosition* (Position Offset) input variable. If you specify 0 for *OffsetPosition* (Position Offset) when you execute the instruction the second time, the offset that is added to the command position is 0.

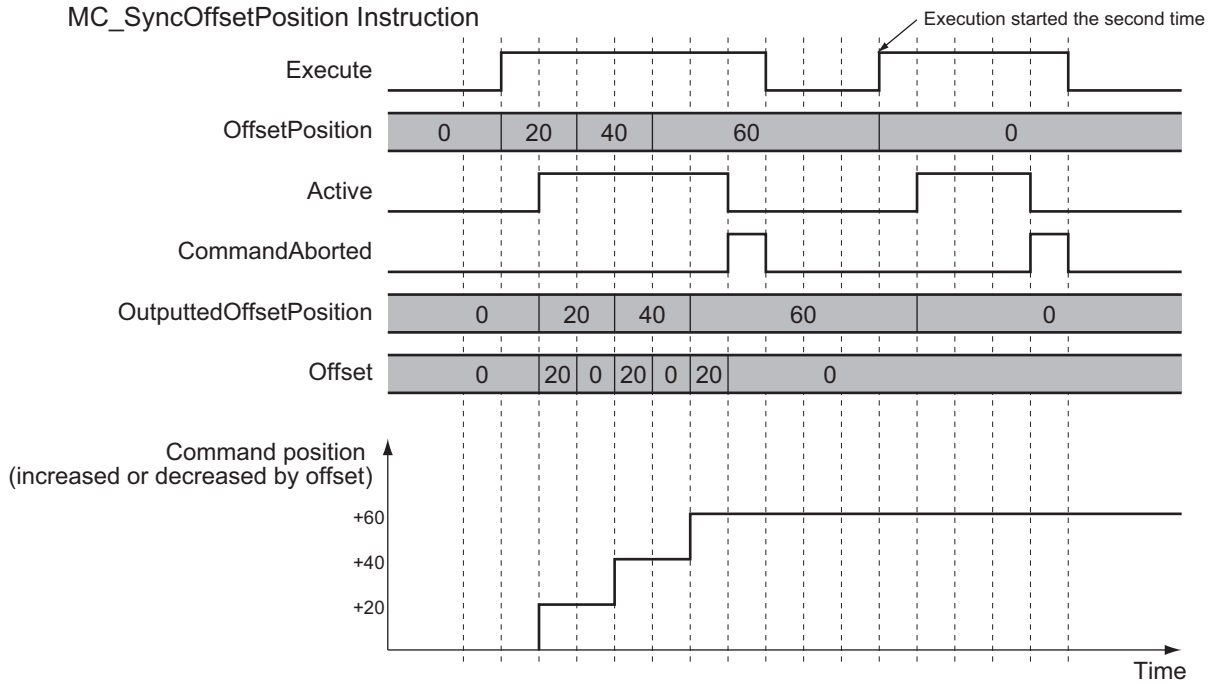

If you want to use the same starting point when you re-execute a previously aborted instruction, use *OutputtedOffsetPosition* (Position Offset Output Value).

As shown in this programming sample, *OutputtedOffsetPosition* (Position Offset Output Value) is used to access the position offset when execution was aborted and it is subtracted from the variable for the input parameter specified for this instruction.

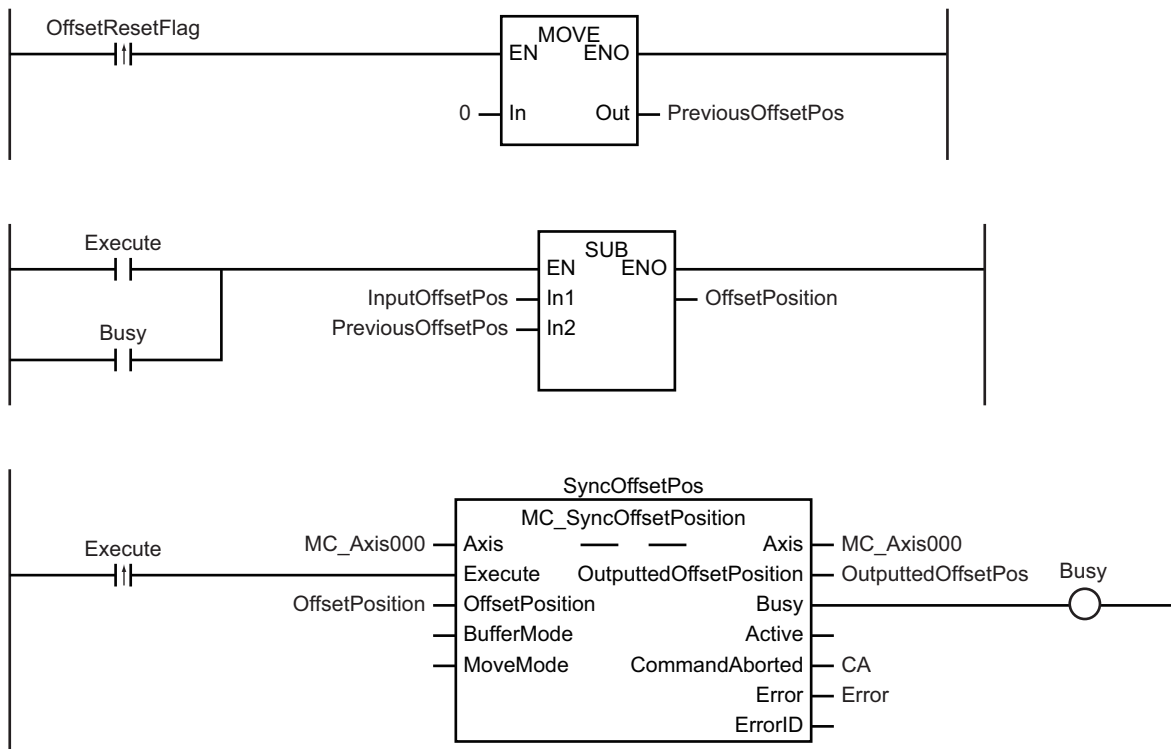

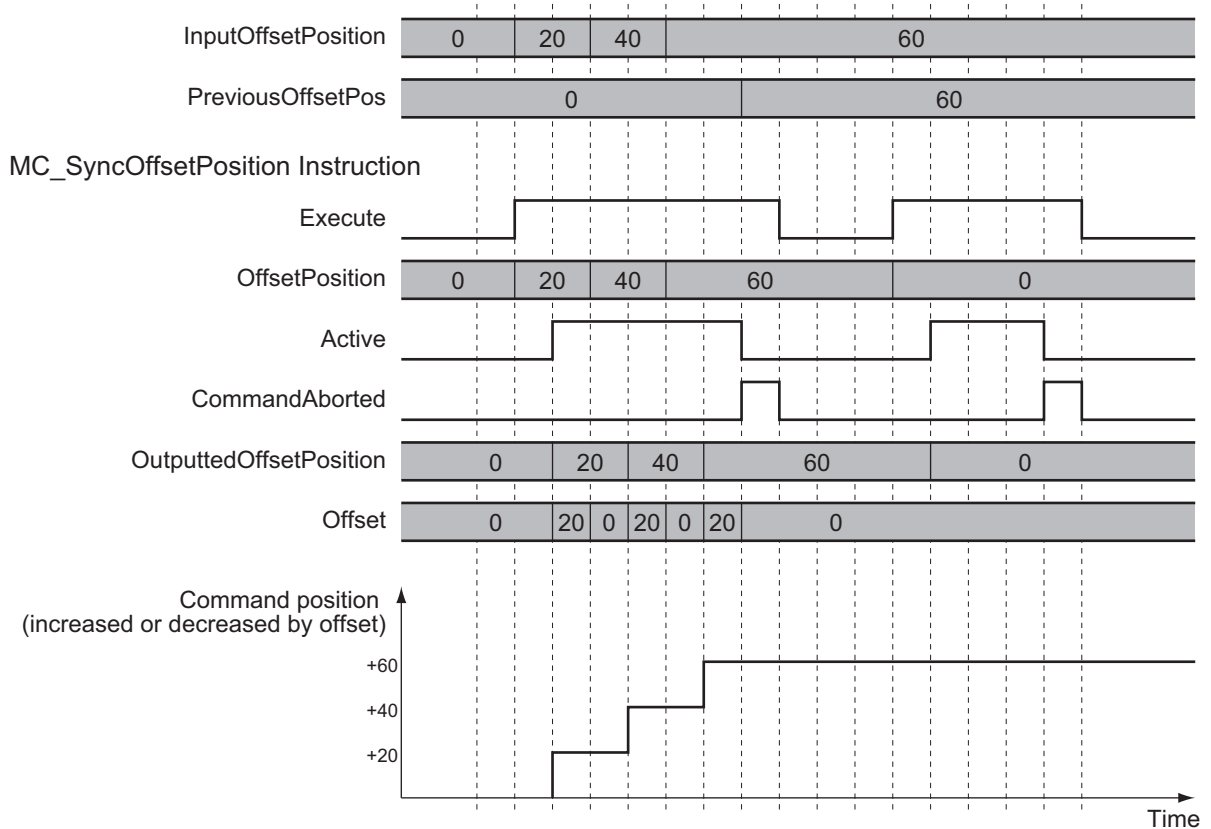
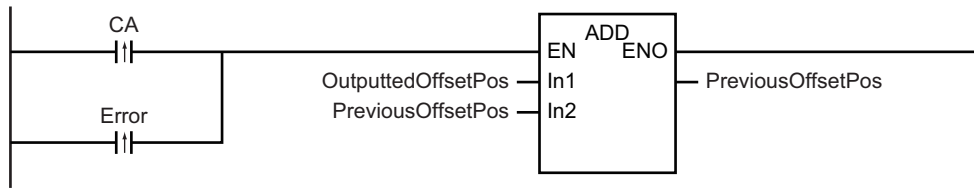

### ● Executable Axis Status

You can execute this instruction for any axis for which *Status.Synchronized* (Synchronized Motion) in the status of the axis specified for *Axis* is TRUE. An error will occur if the instruction is executed for an axis in any other status.

### ● Command Position Handling

The value after the position offset is added is managed as the command position of the axis. Therefore, the following errors may occur depending on the value that you set for the position offset.

- Operation Settings in Axis Parameters
  - a) Maximum Velocity
  - b) Maximum Acceleration
  - c) Maximum Deceleration
  - d) Velocity Warning Value
  - e) Acceleration Warning Value
  - f) Deceleration Warning Value
  - g) In-position Check Time
- Limit Settings in Axis Parameters
  - a) Software Limits

- b) Following Error Over Value
- c) Following Error Warning Value
- Command Position Overflow
- Command Position Underflow

## Timing Charts

The following timing charts show when the position offset is applied when this instruction is executed.

### ● When this Instruction Is Executed in the Primary Periodic Task or Priority-5 Periodic Task

The position offset that is specified for the input is output to the Servo Drive during the next task period.

The following timing chart shows an example of the operation for when this instruction is executed in the primary periodic task.

The same information applies when it is used in a priority-5 periodic task.

MC\_SyncOffsetPosition Instruction

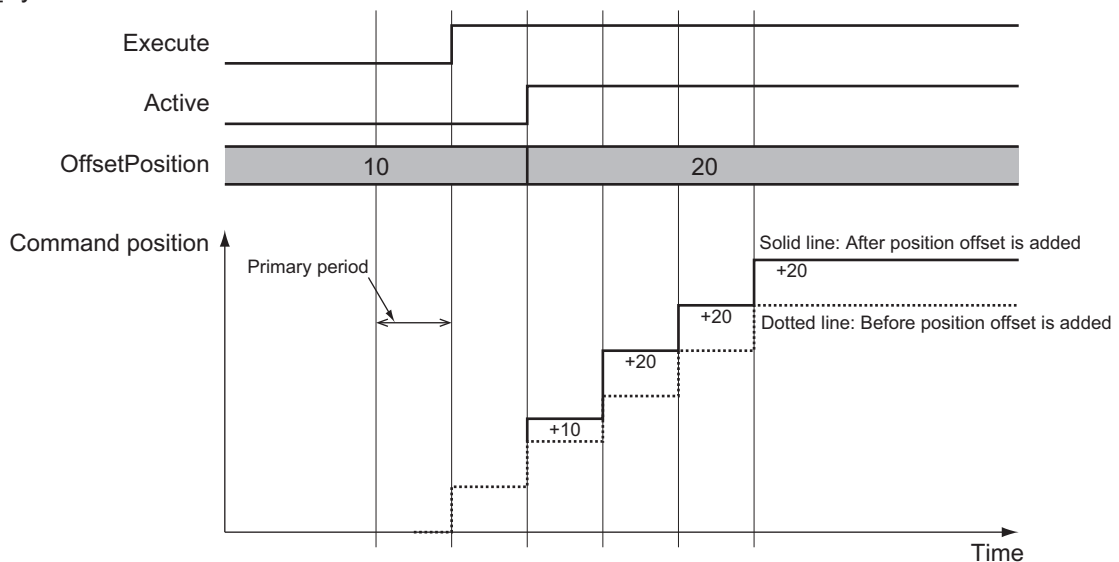

### ● When this Instruction Is Executed in the Priority-16 Periodic Task

The position offset that is specified for the input is output to the Servo Drive one primary period after the next priority-16 periodic task.

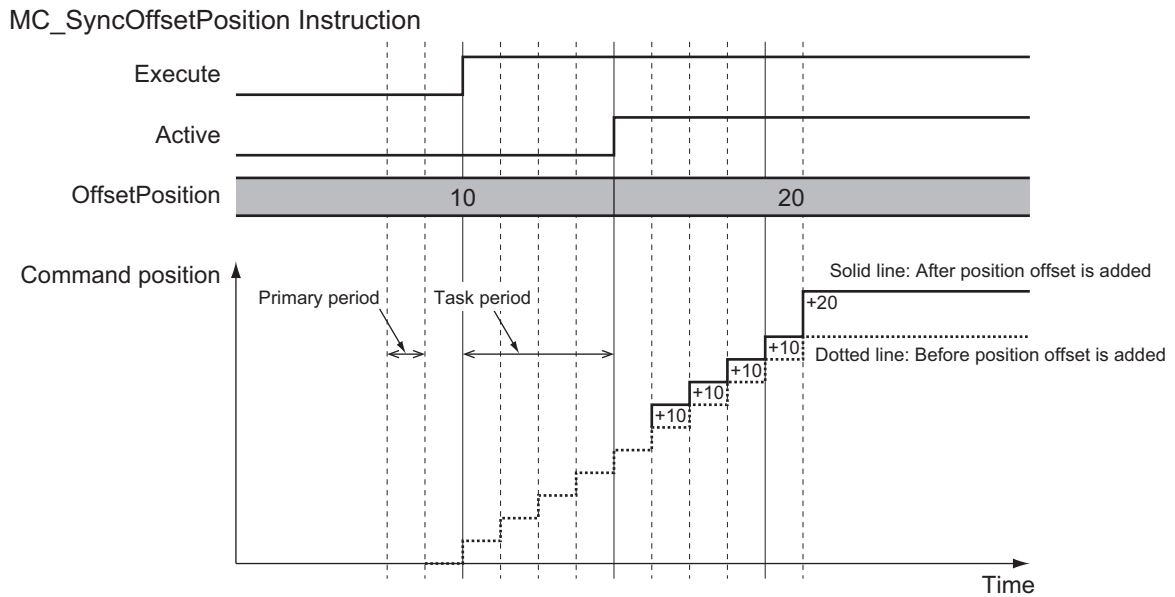

## Re-execution of Motion Control Instructions

This instruction cannot be re-executed.

A Motion Control Instruction Re-execution Disabled error (error code: 543B hex) occurs if re-execution is attempted.

## Multi-execution of Motion Control Instructions

For details on multi-execution of motion control instructions, refer to the *NJ/NX-series CPU Unit Motion Control User's Manual (Cat. No. W507)*.

### ● Multi-execution of Instructions for the Target Synchronized Control Instructions

If you perform multi-execution of instructions for the synchronized control instruction for which this instruction is being executed, *CommandAborted* (Instruction Aborted) of this instruction changes to TRUE. If blending is used for multi-execution of two MC\_CamIn (Start Cam Operation) instructions, *CommandAborted* (Instruction Aborted) of this instruction remains FALSE and processing is continued. In this case, the value of *OffsetPosition* (Position Offset) is added to the initial velocity. The following timing chart shows the operation when this instruction is executed for an MC\_GearIn (Start Gear Operation) instruction and multi-execution of instructions is performed for another instance of MC\_GearIn (Start Gear Operation) before execution of the first instance is completed.

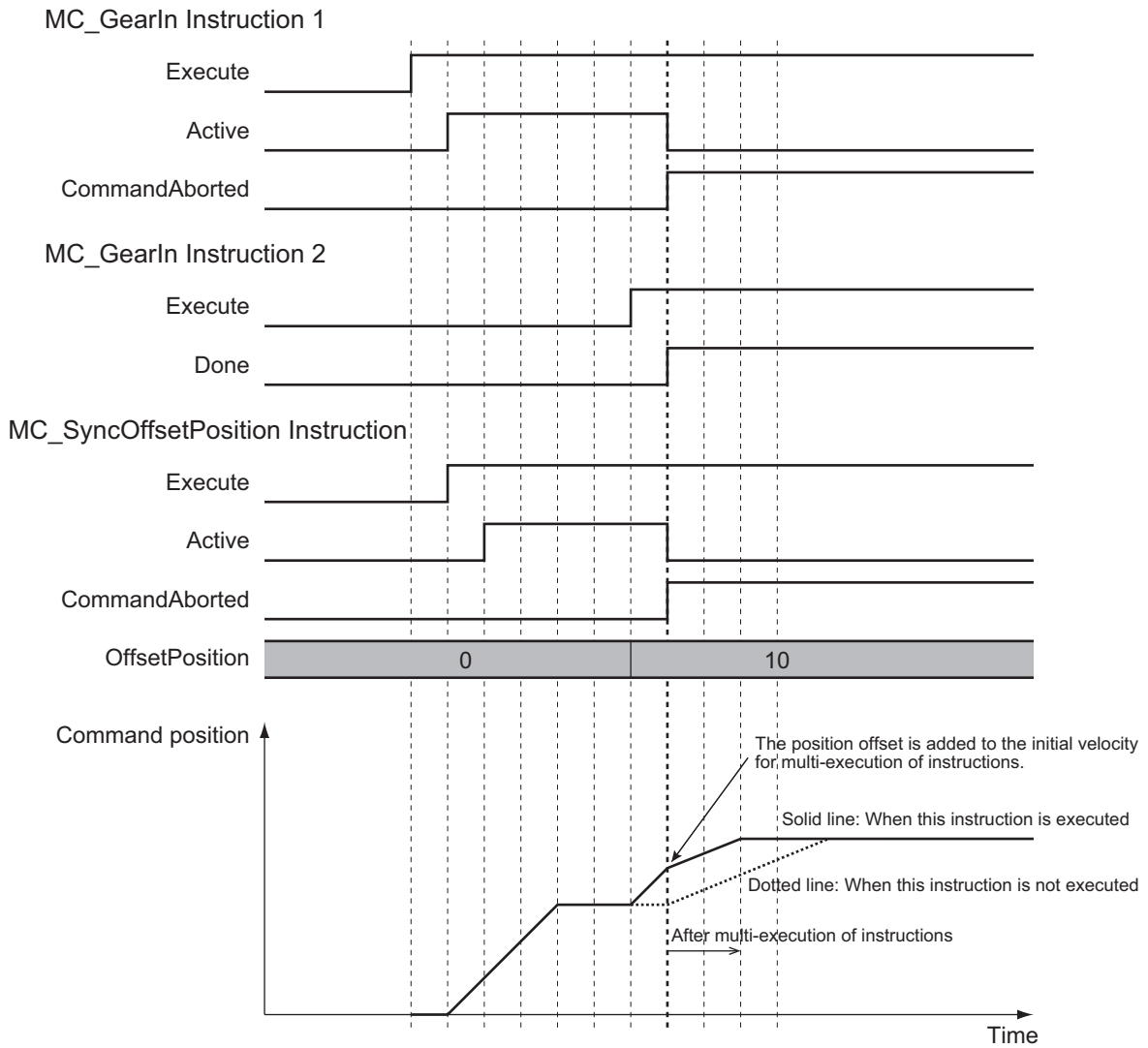

● **Multi-execution of `MC_SyncOffsetPosition` Instructions**

If you perform multi-execution of `MC_SyncOffsetPosition` instructions, `CommandAborted` (Instruction Aborted) of the instance for which execution is currently in progress changes to TRUE and the next instance is executed. The starting point for instances that are executed later is found by adding the position offset that was output one cycle before the previous instance was aborted. There are no other instructions for which execution is aborted when multi-execution of instructions is used for this instruction.

A timing chart for multi-execution of `MC_SyncOffsetPosition` instructions is shown below.



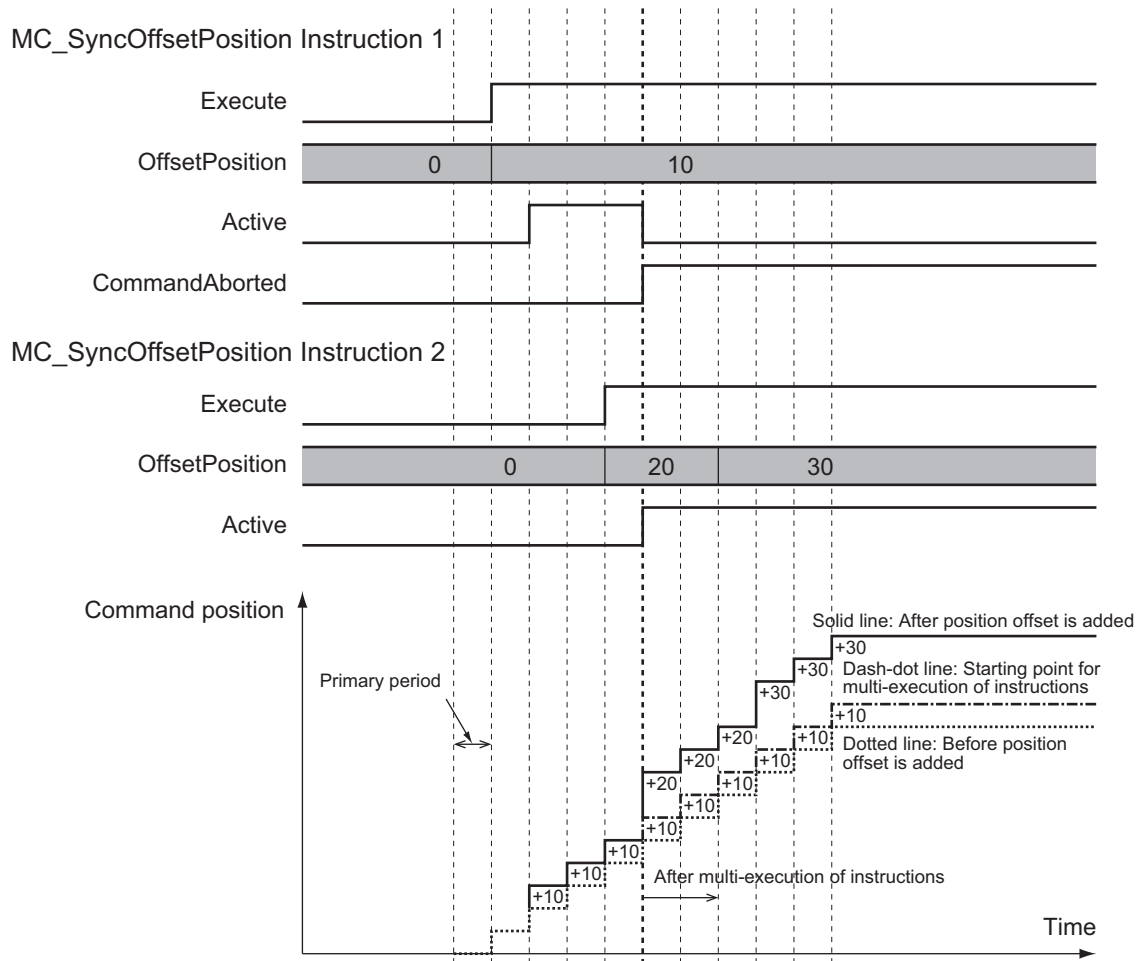

## Errors

If an error occurs during instruction execution, *Error* will change to TRUE.

You can find out the cause of the error by referring to the value output by *ErrorID* (Error Code).

### ● Timing Chart When Error Occurs

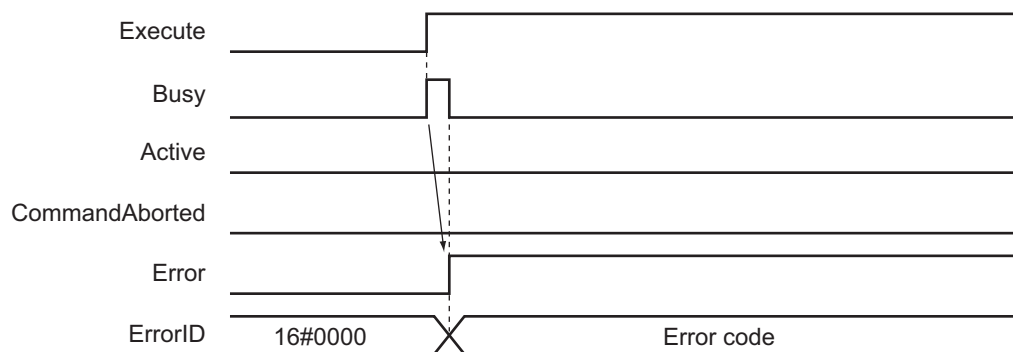

### ● Error Codes

Refer to the *NJ/NX-series Troubleshooting Manual (Cat. No. W503)* for instruction errors.

# MC\_OffsetPosition

The MC\_OffsetPosition instruction adds the specified position offset to the command current position of the slave axis in synchronized control with an acceleration/deceleration curve applied, and outputs the result.

Instruction	Name	FB/ FUN	Graphic expression	ST expression
MC_OffsetPosition	Position Offset Compensation	FB		<pre>MC_OffsetPosition_instance(   Axis :=parameter ,   Execute :=parameter,   OffsetPosition :=parameter,   Velocity :=parameter,   Acceleration :=parameter,   Deceleration :=parameter,   Jerk :=parameter,   BufferMode :=parameter,   MoveMode :=parameter,   Done =&gt;parameter,   OutputtedOffsetPosition =&gt;parameter,   Busy =&gt;parameter,   Active =&gt;parameter,   CommandAborted =&gt;parameter,   Error =&gt;parameter,   ErrorID =&gt;parameter );</pre>



## Version Information

A CPU Unit with the following unit version and Sysmac Studio version 1.28 or higher are required to use this instruction.

CPU Unit	Compatible unit versions
NX102 CPU Unit	Version 1.32 or later
NX1P2 CPU Unit	Version 1.21 or later
NJ-series CPU Unit	Version 1.21 or later

## Variables

### Input Variables

Name	Meaning	Data type	Valid range	Default	Description
Execute	Execute	BOOL	TRUE or FALSE	FALSE	The instruction is executed when the value of this variable changes to TRUE.
OffsetPosition	Position Offset	LREAL	Negative number, positive number, or 0	0	Specifies the position offset to add to the command current position. The unit is command units. *1

Name	Meaning	Data type	Valid range	Default	Description
Velocity	Target velocity	LREAL	Positive number	0	Specifies the target velocity. *2 The unit is command units/s. *1
Acceleration	Acceleration Rate	LREAL	Non-negative number	0	Specifies the acceleration rate. The unit is command units/s <sup>2</sup> . *1
Deceleration	Deceleration Rate	LREAL	Non-negative number	0	Specifies the deceleration rate. The unit is command units/s <sup>2</sup> . *1
Jerk (Reserved)	Jerk	LREAL	0	0	Specifies the jerk. The unit is command units/s <sup>3</sup> . *1
BufferMode (Reserved)	Buffer Mode Selection	_eMC_BUFFER_MODE	0: _mcAborting	0 *3	Specifies the behavior when executing more than one motion instruction. 0: Aborting
MoveMode	Travel Mode	_eMC_MOVE_MODE	1: _mcRelative	1 *3	Selects the travel method. 1: Relative positioning

\*1. Refer to *Unit Conversion Settings* in the *NJ/NX-series CPU Unit Motion Control User's Manual (Cat. No. W507)* for information on command units.

\*2. Always set the target velocity. If the axis is moved without setting a target velocity, an error will occur.

\*3. The default value for an enumeration variable is actually not the number, but the enumerator.

## Output Variables

Name	Meaning	Data type	Valid range	Description
Done	Done	BOOL	TRUE or FALSE	TRUE when the instruction is completed.
OutputtedOffsetPosition	Position Offset Output Value	LREAL	Negative number, positive number, or 0	Contains the position offset that was added to the command current position. The value is updated when <i>Active</i> is TRUE. Updating is stopped and the value is retained when <i>CommandAborted</i> or <i>Error</i> is TRUE.
Busy	Executing	BOOL	TRUE or FALSE	TRUE when the instruction is acknowledged.
Active	Controlling	BOOL	TRUE or FALSE	TRUE when control is in progress.
CommandAborted	Command Aborted	BOOL	TRUE or FALSE	TRUE when the instruction is aborted.
Error	Error	BOOL	TRUE or FALSE	TRUE while there is an error.
ErrorID	Error Code	WORD	*1	Contains the error code when an error occurs. A value of 16#0000 indicates normal execution.

\*1. The upper four digits of the event code give the error code for ErrorID. Refer to the *NJ/NX-series Troubleshooting Manual (Cat. No. W503)* for the event codes.

### ● Output Variable Update Timing

Name	Timing for changing to TRUE	Timing for changing to FALSE
Done	When positioning is completed.	<ul style="list-style-type: none"> <li>When <i>Execute</i> is TRUE and changes to FALSE.</li> <li>After one period when <i>Execute</i> is FALSE.</li> </ul>

Name	Timing for changing to TRUE	Timing for changing to FALSE
Busy	When <i>Execute</i> changes to TRUE.	<ul style="list-style-type: none"> <li>When <i>Done</i> changes to TRUE.</li> <li>When <i>Error</i> changes to TRUE.</li> <li>When <i>CommandAborted</i> changes to TRUE.</li> </ul>
Active	When the instruction is started.	<ul style="list-style-type: none"> <li>When <i>Done</i> changes to TRUE.</li> <li>When <i>Error</i> changes to TRUE.</li> <li>When <i>CommandAborted</i> changes to TRUE.</li> </ul>
CommandAborted	<ul style="list-style-type: none"> <li>When execution of the synchronized control instruction is stopped.</li> <li>When this instruction is aborted because another motion control instruction was executed with the Buffer Mode set to <b>Aborting</b>.</li> <li>When this instruction is canceled due to an error.</li> <li>When this instruction is executed while there is an error.</li> <li>When you start this instruction during MC_Stop instruction execution.</li> </ul>	<ul style="list-style-type: none"> <li>When <i>Execute</i> is TRUE and changes to FALSE.</li> <li>After one period when <i>Execute</i> is FALSE.</li> </ul>
Error	When there is an error in the execution conditions or input parameters for the instruction.	When the error is cleared.

## In-Out Variables

Name	Meaning	Data type	Valid range	Description
Axis	Axis	_sAXIS_REF	---	Specifies the axis. *1

- \*1. Specify a user-defined Axis Variable that was created in the Axis Basic Settings of the Sysmac Studio (default: MC\_Axis\*) or a system-defined axis variable name (\_MC\_AX[\*], \_MC1\_AX[\*], or \_MC2\_AX[\*]).  
 If you use Sysmac Studio version 1.29 or higher, you can specify the system-defined axis variable name for AT specification of a user-defined variable. This will allow you to specify the user-defined variable.  
 If you use Sysmac Studio version 1.28 or lower, do not specify any user-defined variable created in the variable table.

## Function

The MC\_OffsetPosition instruction adds an offset specified with *OffsetPosition* (Position Offset), *Velocity* (Target Velocity), *Acceleration* (Acceleration), and *Deceleration* (Deceleration) to the command current position of the slave axis in synchronized control, and outputs the result to the Servo Drive.

The following shows the timing chart for an example in which this instruction is executed during execution of the MC\_GearIn instruction and then is completed.

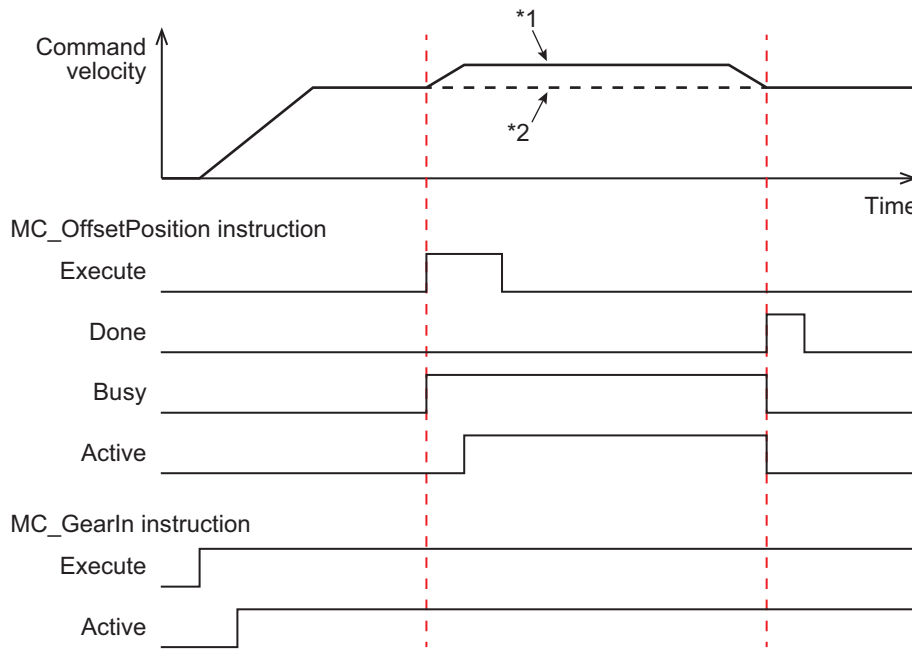

- \*1. When the MC\_OffsetPosition instruction is executed
- \*2. When the MC\_OffsetPosition instruction is not executed

*Done* (Done) changes to TRUE when *OffsetPosition* (Position Offset) is reached.

An in-position check is not performed for this instruction.

When the currently executing synchronized control instruction is completed, *CommandAborted* (Instruction Aborted) of this instruction changes to TRUE.

The following shows the timing chart for an example in which this instruction is executed during execution of the MC\_GearIn (Start Gear Operation) instruction, and then is stopped as *CommandAborted* (Instruction Aborted) for the MC\_GearIn instruction changes to TRUE.

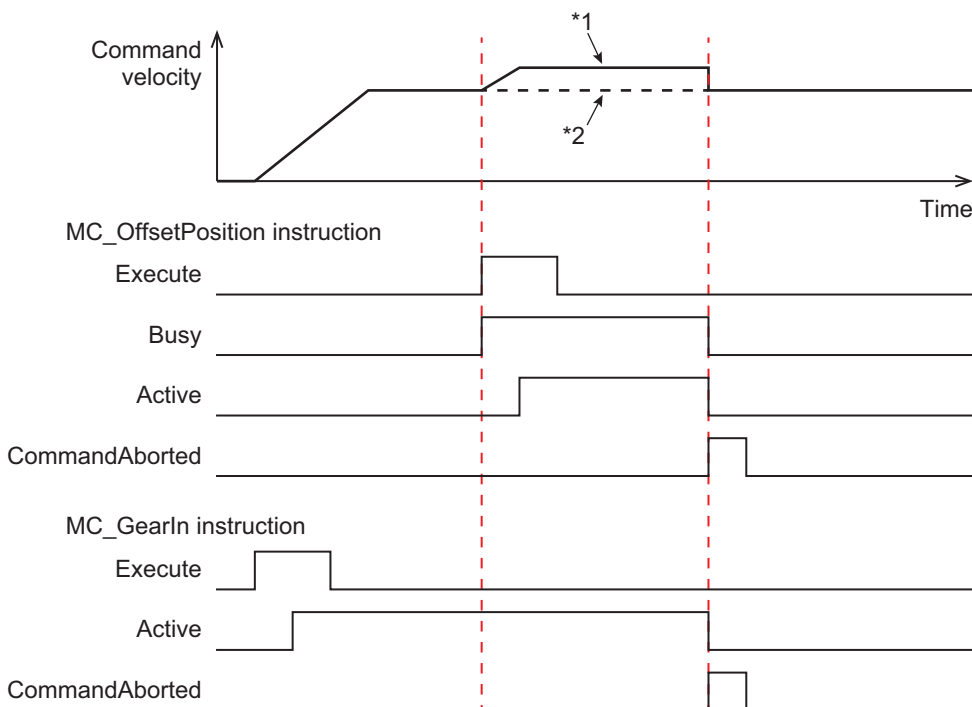

### Executable Axis Status

---

You can execute this instruction for any axis for which *Status.Synchronized* (Synchronized Motion) in the status of the axis specified for *Axis* is TRUE. An error will occur if the instruction is executed for an axis in any other status.

### Axis Limit

---

The axis limit functions for the command position to which the position offset is added.

The specifications of the axis limit depend on the specifications of the synchronized control instruction currently in operation.

The related axis limit values are listed as follows.

- Operation Settings Values
  - a) Maximum velocity
  - b) Maximum acceleration/Maximum deceleration
  - c) Velocity warning value
  - d) Acceleration warning value/Deceleration warning value
- Limit Settings Values
  - a) Following error over value
  - b) Following error warning value
  - c) Software limit values
- Command Position Overflow/Command Position Underflow
- In-position Check

### Re-execution of Motion Control Instructions

---

You can change the operation of the instruction if you change an input variable during positioning and change *Execute* to TRUE again.

Input variables *OffsetPosition* (Position Offset), *Velocity* (Target Velocity), *Acceleration* (Acceleration Rate), and *Deceleration* (Deceleration Rate) can be changed by re-executing the motion control instruction.

For details on re-execution of motion control instructions, refer to the *NJ/NX-series CPU Unit Motion Control User's Manual (Cat. No. W507)*.

### Multi-execution of Motion Control Instructions

---

You cannot execute another motion control instruction during execution of this instruction.

A Motion Control Instruction Multi-execution Disabled error (error code: 543C hex) occurs if an attempt is made to execute multiple instances.

### Errors

---

If an error occurs during instruction execution, *Error* will change to TRUE.

You can find out the cause of the error by referring to the value output by *ErrorID* (Error Code).

● **Timing Chart When Error Occurs**

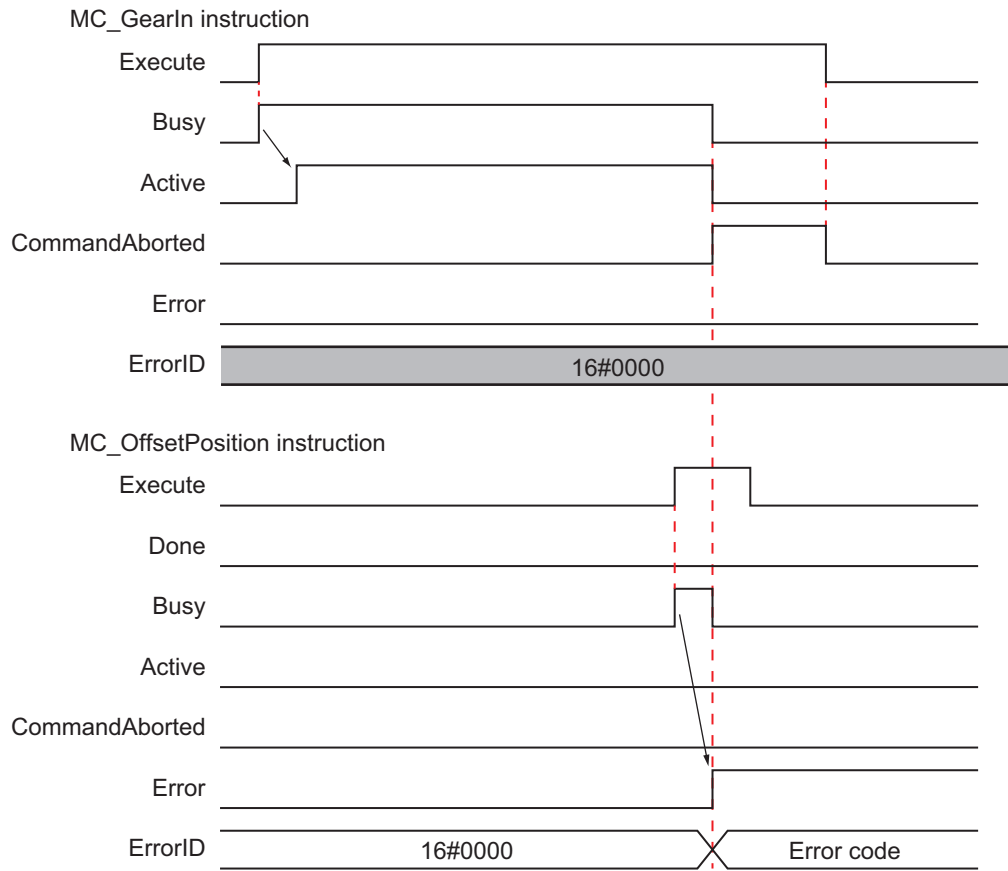

● **Error Codes**

Refer to the *NJ/NX-series Troubleshooting Manual (Cat. No. W503)* for instruction errors.





# 4

## Axes Group Instructions

This section describes the instructions to perform multi-axes coordinated control for the MC Function Module.

4

---

MC_GroupEnable .....	4-2
MC_GroupDisable .....	4-6
MC_MoveLinear .....	4-11
MC_MoveLinearAbsolute.....	4-40
MC_MoveLinearRelative .....	4-43
MC_MoveCircular2D .....	4-46
MC_GroupStop .....	4-74
MC_GroupImmediateStop .....	4-82
MC_GroupSetOverride.....	4-86
MC_GroupReadPosition .....	4-91
MC_ChangeAxesInGroup .....	4-95
MC_GroupSyncMoveAbsolute.....	4-99
MC_GroupReset .....	4-106

# MC\_GroupEnable

The MC\_GroupEnable instruction enables an axes group.

Instruction	Name	FB/ FUN	Graphic expression	ST expression
MC_GroupEnable	Enable Axes Group	FB		<pre>MC_GroupEnable_instance (   AxesGroup :=parameter,   Execute :=parameter,   Done =&gt;parameter,   Busy =&gt;parameter,   CommandAborted =&gt;parameter,   Error =&gt;parameter,   ErrorID =&gt;parameter );</pre>

## Variables

### Input Variables

Name	Meaning	Data type	Valid range	Default	Description
Execute	Execute	BOOL	TRUE or FALSE	FALSE	The instruction is executed when the value of this variable changes to TRUE.

### Output Variables

Name	Meaning	Data type	Valid range	Description
Done	Done	BOOL	TRUE or FALSE	TRUE when the instruction is completed.
Busy	Executing	BOOL	TRUE or FALSE	TRUE when the instruction is acknowledged.
CommandAborted	Command Aborted	BOOL	TRUE or FALSE	TRUE when the instruction is aborted.
Error	Error	BOOL	TRUE or FALSE	TRUE while there is an error.
ErrorID	Error Code	WORD	*1	Contains the error code when an error occurs. A value of 16#0000 indicates normal execution.

\*1. The upper four digits of the event code give the error code for ErrorID. Refer to the *NJ/NX-series Troubleshooting Manual (Cat. No. W503)* for the event codes.

### ● Output Variable Update Timing

Name	Timing for changing to TRUE	Timing for changing to FALSE
Done	When the instruction is completed.	<ul style="list-style-type: none"> <li>When <i>Execute</i> is TRUE and changes to FALSE.</li> <li>After one period when <i>Execute</i> is FALSE.</li> </ul>

Name	Timing for changing to TRUE	Timing for changing to FALSE
Busy	When <i>Execute</i> changes to TRUE.	<ul style="list-style-type: none"> <li>When <i>Done</i> changes to TRUE.</li> <li>When <i>Error</i> changes to TRUE.</li> <li>When <i>CommandAborted</i> changes to TRUE.</li> </ul>
CommandAborted	When this instruction is canceled.	<ul style="list-style-type: none"> <li>When <i>Execute</i> is TRUE and changes to FALSE.</li> <li>After one period when <i>Execute</i> is FALSE.</li> </ul>
Error	When there is an error in the execution conditions or input parameters for the instruction.	When the error is cleared.

## In-Out Variables

Name	Meaning	Data type	Valid range	Description
AxesGroup	Axes Group	_sGROUP_RE EF	---	Specify the axes group. *1

- \*1. Specify a user-defined Axes Group Variable that was created in the Axes Group Basic Settings of the Sysmac Studio (default: MC\_Group\*) or a system-defined axes group variable name (\_MC\_GRP[\*], \_MC1\_GRP[\*], or \_MC2\_GRP[\*]). If you use Sysmac Studio version 1.29 or higher, you can specify the system-defined axes group variable name for AT specification of a user-defined variable. This will allow you to specify the user-defined variable. If you use Sysmac Studio version 1.28 or lower, do not specify any user-defined variable created in the variable table.

## Function

Before describing the function of this instruction, the different states of axes groups are explained.

- Axes groups have two states, the *GroupEnable* and *GroupDisable* states.

State	Description
GroupEnable	Multi-axes coordinated control is enabled. You can execute any multi-axes coordinated control instructions except for the MC_ChangeAxesInGroup (Change Axes In Group) instruction.
GroupDisable	Multi-axes coordinated control is disabled. You can execute only the following multi-axes coordinated control instructions. <ul style="list-style-type: none"> <li>MC_GroupEnable (Enable Axes Group) instruction</li> <li>MC_GroupDisable (Disable Axes Group) instruction</li> <li>MC_GroupReset (Group Reset) instruction</li> <li>MC_GroupSetOverride (Set Group Overrides) instruction</li> <li>MC_GroupReadPosition (Read Axes Group Position) instruction</li> <li>MC_ChangeAxesInGroup (Change Axes in Group) instruction</li> </ul>

- To perform multi-axes coordinated control, an axes group must be in a *GroupEnable* state.

You can monitor the Axes Group Variables in the system-defined variables for motion control to see if axes groups are enabled or disabled.

Here, the Axes Group Variables are described using \_MC\_GRP[\*] as an example.

The same information applies to \_MC1\_GRP[\*] and \_MC2\_GRP[\*].

Name	Meaning	Description
_MC_GRP*.Status.Ready	Axes Group Enabled	TRUE when the axes group is stopped and preparations to execute an axes group instruction are completed.
_MC_GRP*.Status.Disabled	Axes Group Disabled	TRUE when the axes group is disabled and stopped.

**Note** \* in `_MC_GRP*` is replaced by a number between 0 and 63 for NX701 CPU Units, a number between 0 and 7 for NX102 and NX1P2 CPU Units, and a number between 0 and 31 for NX502 and NJ-series CPU Units.

## Basic Function

- The `MC_GroupEnable` (Enable Axes Group) instruction places the axes group specified by `AxesGroup` into the `GroupEnable` state.
- When an axes group is in the `GroupEnable` state, you can execute any multi-axes coordinated control instructions for the axes group.
- You can set only **Servo Axis** and **Virtual Servo Axis** in an axes group. An error will occur if you include other axis types.
- All axes that belong to an axes group must be in a stopped state to enable the group. An axis is stopped if the `Status.Disabled` (Axis Disabled) or `Status.Standstill` (Standstill) in the Axis Variable is TRUE.
- If there are axes that already belong to another axes group and the other axes group is enabled, the `MC_GroupEnable` instruction is not executed and an error will occur if you attempt to execute it.
- When an axes group is enabled, the axes in the axes group change to Coordinated Motion status. `Status.Coordinated` (Coordinated Motion) in the Axis Variable changes to TRUE.
- An axes group is disabled if the `MC_GroupDisable` (Disable Axes Group) instruction is executed, if operation is stopped by changing to PROGRAM mode, or if a MC Test Run is started.



### Precautions for Correct Use

- To use an axes group, create an axes group on the Sysmac Studio and download the settings to the CPU Unit. You cannot change the axes in an axes group from the user program. For a CPU Unit with unit version 1.01 or later and Sysmac Studio version 1.02 or higher, you can use the `MC_ChangeAxesInGroup` (Change Axes in Group) instruction to temporarily change axes groups.
- Use the Synchronize Menu of the Sysmac Studio to download the project.

## Timing Charts

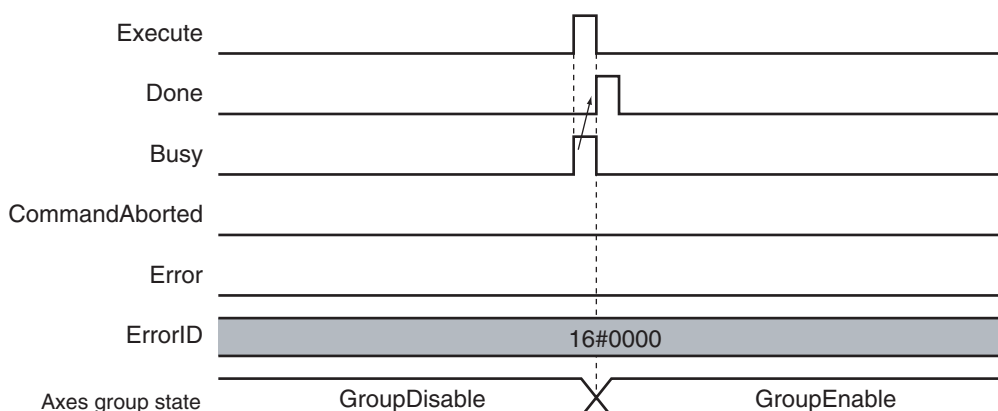

## Errors

If an error occurs during instruction execution, `Error` will change to TRUE.

You can find out the cause of the error by referring to the value output by *ErrorID* (Error Code).

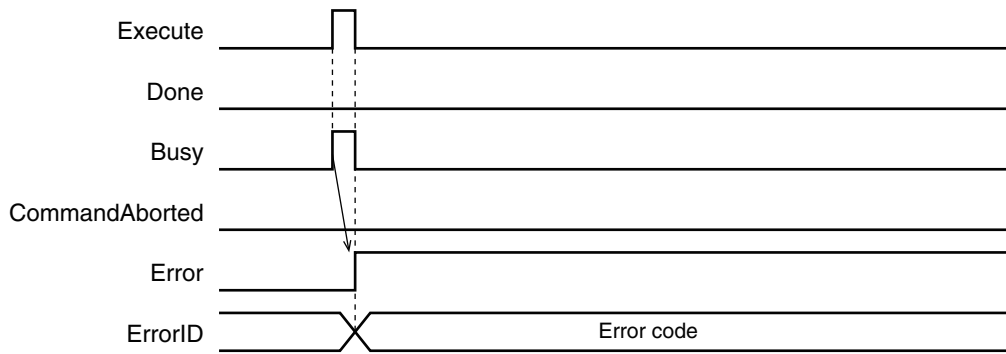

**Additional Information**

Errors do not occur for individual axes in an axes group even if an error occurs for the axes group.

● **Error Codes**

Refer to the *NJ/NX-series Troubleshooting Manual (Cat. No. W503)* for instruction errors.

# MC\_GroupDisable

The MC\_GroupDisable instruction disables an axes group.

Instruction	Name	FB/ FUN	Graphic expression	ST expression
MC_GroupDisable	Disable Axes Group	FB		<pre>MC_GroupDisable_instance (   AxesGroup :=parameter,   Execute :=parameter,   Done =&gt;parameter,   Busy =&gt;parameter,   CommandAborted =&gt;parameter,   Error =&gt;parameter,   ErrorID =&gt;parameter );</pre>

## Variables

### Input Variables

Name	Meaning	Data type	Valid range	Default	Description
Execute	Execute	BOOL	TRUE or FALSE	FALSE	The instruction is executed when the value of this variable changes to TRUE.

### Output Variables

Name	Meaning	Data type	Valid range	Description
Done	Done	BOOL	TRUE or FALSE	TRUE when the instruction is completed.
Busy	Executing	BOOL	TRUE or FALSE	TRUE when the instruction is acknowledged.
CommandAborted	Command Aborted	BOOL	TRUE or FALSE	TRUE when the instruction is aborted.
Error	Error	BOOL	TRUE or FALSE	TRUE while there is an error.
ErrorID	Error Code	WORD	*1	Contains the error code when an error occurs. A value of 16#0000 indicates normal execution.

\*1. The upper four digits of the event code give the error code for ErrorID. Refer to the *NJ/NX-series Troubleshooting Manual (Cat. No. W503)* for the event codes.

### ● Output Variable Update Timing

Name	Timing for changing to TRUE	Timing for changing to FALSE
Done	When the axes group state is changed to <i>GroupDisable</i> .	<ul style="list-style-type: none"> <li>When <i>Execute</i> is TRUE and changes to FALSE.</li> <li>After one period when <i>Execute</i> is FALSE.</li> </ul>

Name	Timing for changing to TRUE	Timing for changing to FALSE
Busy	When <i>Execute</i> changes to TRUE.	<ul style="list-style-type: none"> <li>When <i>Done</i> changes to TRUE.</li> <li>When <i>Error</i> changes to TRUE.</li> <li>When <i>CommandAborted</i> changes to TRUE.</li> </ul>
CommandAborted	Never changes to TRUE. (Reserved)	<ul style="list-style-type: none"> <li>When <i>Execute</i> is TRUE and changes to FALSE.</li> <li>After one period when <i>Execute</i> is FALSE.</li> </ul>
Error	When there is an error in the execution conditions or input parameters for the instruction.	When the error is cleared.

## In-Out Variables

Name	Meaning	Data type	Valid range	Description
AxesGroup	Axes Group	_sGROUP_RE	---	Specify the axes group. *1

- \*1. Specify a user-defined Axes Group Variable that was created in the Axes Group Basic Settings of the Sysmac Studio (default: MC\_Group\*) or a system-defined axes group variable name (\_MC\_GRP[\*], \_MC1\_GRP[\*], or \_MC2\_GRP[\*]). If you use Sysmac Studio version 1.29 or higher, you can specify the system-defined axes group variable name for AT specification of a user-defined variable. This will allow you to specify the user-defined variable. If you use Sysmac Studio version 1.28 or lower, do not specify any user-defined variable created in the variable table.

## Function

- The MC\_GroupDisable instruction disables an axes group.  
For details on the axes group states, refer to *Function* on page 4-3.
- The MC\_GroupDisable (Disable Axes Group) instruction places the axes group specified by *AxesGroup* into the *GroupDisable* state.  
When an axes group is in the *GroupDisable* state, the axes group stops acknowledging multi-axes coordinated control instructions.
- Any buffered instruction of the specified *AxesGroup* is cleared when the axes group state changes to *GroupDisable*.
- The axes group is disabled even while operation is stopped.  
When an axes group is disabled, the status of the axes in the axes group changes from TRUE for *Status.Coordinated* (Coordinated Motion) to the status of each axis.  
Use *Status* (Axis Status) in the Axis Variable to determine the status of each axis.

## Timing Charts

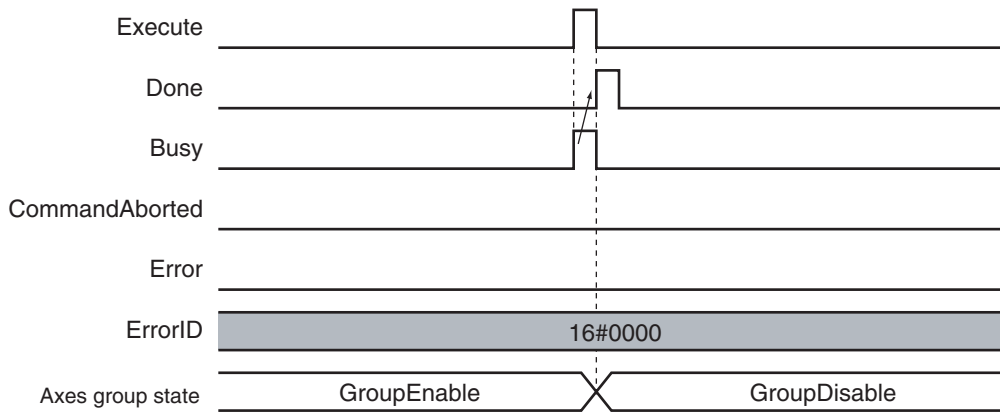

If you execute the MC\_GroupDisable instruction for an *AxisGroup* that is under multi-axes coordinated control, *CommandAborted* of multi-axes coordinated control instruction will change to TRUE. *CommandAborted* of any buffered multi-axes coordinated control instruction will also change to TRUE. If the axes are moving, they will decelerate to a stop at the maximum deceleration rate for each axis.



Multi-axes Coordinated Control 1 (Example: MC\_MoveLinearAbsolute)

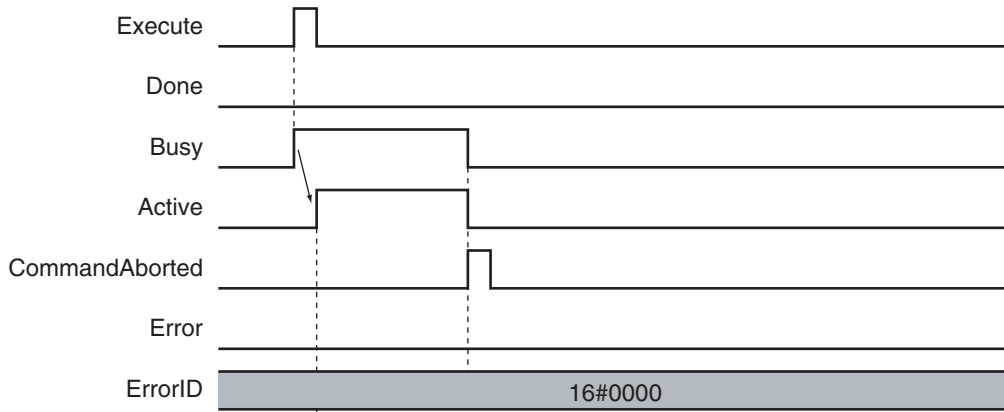

Multi-axes Coordinated Control 2 (Example: MC\_MoveLinearAbsolute with *Buffered*)

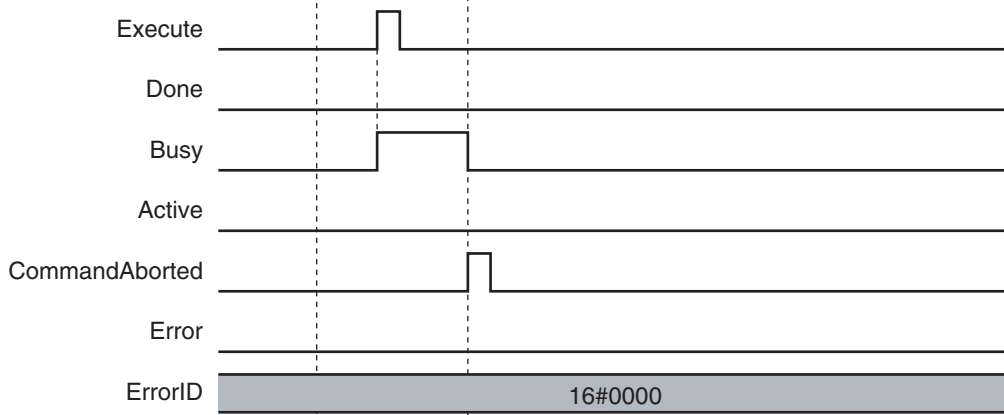

**MC\_GroupDisable**

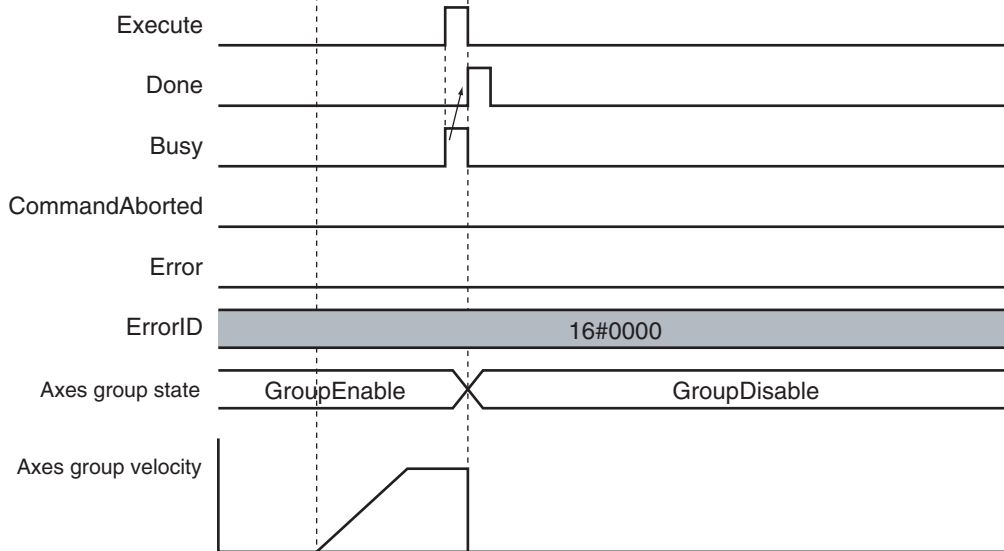

**Errors**

If an error occurs during instruction execution, *Error* will change to TRUE. You can find out the cause of the error by referring to the value output by *ErrorID* (Error Code).

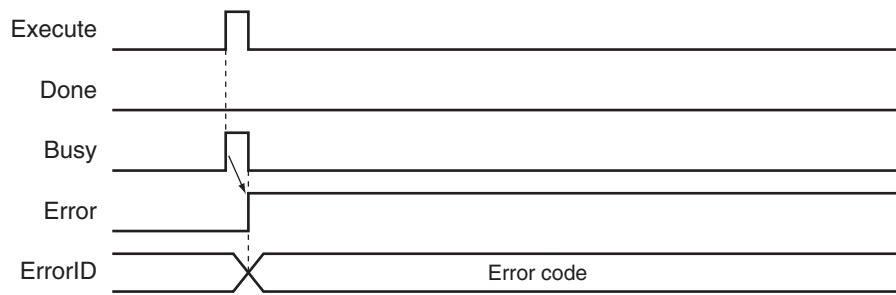

### ● Error Codes

Refer to the *NJ/NX-series Troubleshooting Manual (Cat. No. W503)* for instruction errors.

# MC\_MoveLinear

The MC\_MoveLinear instruction performs linear interpolation.

Instruction	Name	FB/ FUN	Graphic expression	ST expression
MC_MoveLinear	Linear Interpolation	FB		<pre>MC_MoveLinear_instance (   AxesGroup :=parameter,   Execute :=parameter,   Position :=parameter,   Velocity :=parameter,   Acceleration :=parameter,   Deceleration :=parameter,   Jerk :=parameter,   CoordSystem :=parameter,   BufferMode :=parameter,   TransitionMode :=parameter,   MoveMode :=parameter,   Done =&gt;parameter,   Busy =&gt;parameter,   Active =&gt;parameter,   CommandAborted =&gt;parameter,   Error =&gt;parameter,   ErrorID =&gt;parameter );</pre>

## Variables

### Input Variables

Name	Meaning	Data type	Valid range	De- fault	Description
Execute	Execute	BOOL	TRUE or FALSE	FALS E	The instruction is executed when the value of this variable changes to TRUE.
Position	Target Position	ARRAY[0..3] OF LREAL	Negative number, positive number, or 0	0	Specify the target position for linear interpolation. The unit is command units. *1
Velocity*2	Target Velocity	LREAL	Positive number	0	Specify the target velocity. The unit is command units/s. *1
Acceleration	Acceleration Rate	LREAL	Non-negative number	0	Specify the acceleration rate. The unit is command units/s <sup>2</sup> . *1
Deceleration	Deceleration Rate	LREAL	Non-negative number	0	Specify the deceleration rate. The unit is command units/s <sup>2</sup> . *1

Name	Meaning	Data type	Valid range	Default	Description
Jerk	Jerk	LREAL	Non-negative number	0	Specify the jerk. The unit is command units/s <sup>3</sup> . *1
CoordSystem	Coordinate System	_eMC_COORD_SYSTEM	0: _mcACS	0*3	Specify the coordinate system. 0: Axis coordinate system (ACS)
BufferMode	Buffer Mode Selection	_eMC_BUFFER_MODE	0: _mcAborting 1: _mcBuffered 2: _mcBlendingLow 3: _mcBlendingPrevious 4: _mcBlendingNext 5: _mcBlendingHigh	0*3	Specify the behavior when executing more than one motion instruction. 0: Aborting 1: Buffered 2: Blending low 3: Blending previous 4: Blending next 5: Blending high
Transition-Mode	Transition Mode	_eMC_TRANSITION_MODE	0: _mcTMNone 10: _mcTMCornerSuperimposed	0*3	Specify the path of motion. 0: Transition disabled 10: Superimpose corners
MoveMode	Travel Mode	_eMC_MOVE_MODE	0: _mcAbsolute 1: _mcRelative	0*3	Select the travel method. 0: Absolute positioning 1: Relative positioning

\*1. Refer to *Unit Conversion Settings* in the *NJ/NX-series CPU Unit Motion Control User's Manual (Cat. No. W507)* for information on command units.

\*2. Always set the target velocity. If the axes are moved without setting a target velocity, an error will occur.

\*3. The default value for an enumeration variable is actually not the number, but the enumerator.

## Output Variables

Name	Meaning	Data type	Valid range	Description
Done	Done	BOOL	TRUE or FALSE	TRUE when the instruction is completed.
Busy	Executing	BOOL	TRUE or FALSE	TRUE when the instruction is acknowledged.
Active	Controlling	BOOL	TRUE or FALSE	TRUE when the axis is being controlled.
CommandAborted	Command Aborted	BOOL	TRUE or FALSE	TRUE when the instruction is aborted.
Error	Error	BOOL	TRUE or FALSE	TRUE while there is an error.
ErrorID	Error Code	WORD	*1	Contains the error code when an error occurs. A value of 16#0000 indicates normal execution.

\*1. The upper four digits of the event code give the error code for ErrorID. Refer to the *NJ/NX-series Troubleshooting Manual (Cat. No. W503)* for the event codes.

## ● Output Variable Update Timing

Name	Timing for changing to TRUE	Timing for changing to FALSE
Done	When positioning is completed.	<ul style="list-style-type: none"> <li>When <i>Execute</i> is TRUE and changes to FALSE.</li> <li>After one period when <i>Execute</i> is FALSE.</li> </ul>
Busy	When <i>Execute</i> changes to TRUE.	<ul style="list-style-type: none"> <li>When <i>Done</i> changes to TRUE.</li> <li>When <i>Error</i> changes to TRUE.</li> <li>When <i>CommandAborted</i> changes to TRUE.</li> </ul>
Active	When the axes move.	<ul style="list-style-type: none"> <li>When <i>Done</i> changes to TRUE.</li> <li>When <i>Error</i> changes to TRUE.</li> <li>When <i>CommandAborted</i> changes to TRUE.</li> </ul>
CommandAborted	<ul style="list-style-type: none"> <li>When this instruction is aborted because another motion control instruction was executed with the Buffer Mode set to <b>Aborting</b>.</li> <li>When this instruction is canceled due to an error.</li> <li>When this instruction is executed while there is an error.</li> <li>When you start this instruction during MC_GroupStop instruction execution.</li> </ul>	<ul style="list-style-type: none"> <li>When <i>Execute</i> is TRUE and changes to FALSE.</li> <li>After one period when <i>Execute</i> is FALSE.</li> </ul>
Error	When there is an error in the execution conditions or input parameters for the instruction.	When the error is cleared.

## In-Out Variables

Name	Meaning	Data type	Valid range	Description
AxesGroup	Axes Group	_sGROUP_REF	---	Specify the axes group. *1

- \*1. Specify a user-defined Axes Group Variable that was created in the Axes Group Basic Settings of the Sysmac Studio (default: MC\_Group\*) or a system-defined axes group variable name (\_MC\_GRP[\*], \_MC1\_GRP[\*], or \_MC2\_GRP[\*]). If you use Sysmac Studio version 1.29 or higher, you can specify the system-defined axes group variable name for AT specification of a user-defined variable. This will allow you to specify the user-defined variable. If you use Sysmac Studio version 1.28 or lower, do not specify any user-defined variable created in the variable table.

## Function

- The MC\_MoveLinear instruction performs linear interpolation for 2 to 4 axes.



### Precautions for Correct Use

- An Instruction Execution Error with Undefined Home (error code: 5466 hex) occurs if home is undefined for any of the composition axes in the axes group.
- You cannot execute an instruction to perform linear interpolation if a limit input is ON for any of the logical axes that belong to the axes group.

## Instruction Details

This section describes the instruction in detail.

## ● Linear Interpolation Procedure

Use the following procedure to perform linear interpolation.

### 1 Registering Axes Groups for Interpolation

- Select the axes group to perform interpolation.  
An axes group is represented by `_MC_GRP[*]`, or by `_MC1_GRP[*]`, and `_MC2_GRP[*]`.
- Specify the axis composition with **Composition** of the Axes Group Variable. You can specify two to four axes.
- Specify the combination of axes to perform interpolation with **Axis Selection** of the Axes Group Variable.
- Use logical axes (axis A0 to A3) for the axes, and not axis numbers.
- Specify axis numbers for the logical axes A0 to A3 in order from the lowest number with **Axis Selection**.
- The axis number is specified as follows according to the model or series.

Model or series	Axis number
NX701 CPU Unit	Axis 0 to Axis 255
NX502 CPU Unit	Axis 0 to Axis 255
NX102 CPU Unit	Axis 0 to Axis 14
NX1P2 CPU Unit	Axis 0 to Axis 11
NJ-series CPU Unit	Axis 0 to Axis 63



### Additional Information

For the details of the axis numbers, refer to the *NJ/NX-series CPU Unit Motion Control User's Manual (Cat. No. W507)*.

- In the Axes Group Basic Settings of the Sysmac Studio, select the axis composition to use for **Composition** and assign an axis number to the logical axis. The following example shows a 3-axis axes group that is called **MC\_Group000** with the following axes registered in it: `MC_Axis000`, `MC_Axis001`, and `MC_Axis002`.

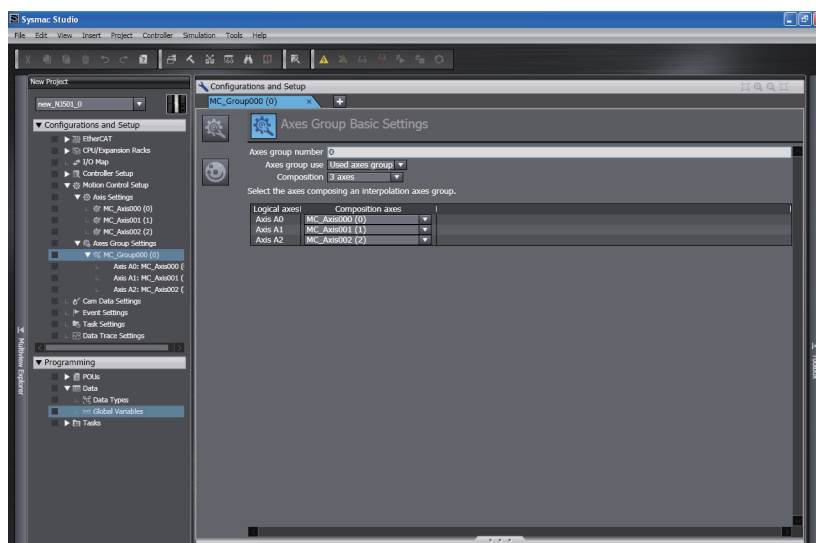



### Precautions for Correct Use

An Instruction Not Allowed for Encoder Axis Type error (543D hex) will occur and operation will end if an encoder axis or virtual encoder axis is included in the axes group. Make sure that you select only **Servo Axes** or **Virtual Servo Axes**.

## 2 Enabling the Axes Group

- Turn ON the Servo for the composition axes of the axes group, and then define home for each of the composition axes.
- Execute the MC\_GroupEnable instruction to enable the registered axes group.

Using the Linear Interpolation instruction is now enabled.

## ● Position (Target Position)

- Set the target position in *Position* (Target Position) for all of the axes specified with **Axis Selection** of the Axes Group Variable.
- You must create a 1×4 array variable in the Sysmac Studio to assign *Position* (A0, A1, A2, and A3). You can use any variable name.

Assign the target positions for the axis to the elements of that array.

Always create a 1×4 array even if there are fewer than four axes in the axes group.

An example is shown below when the *Pos1* array variable is declared on the Sysmac Studio.

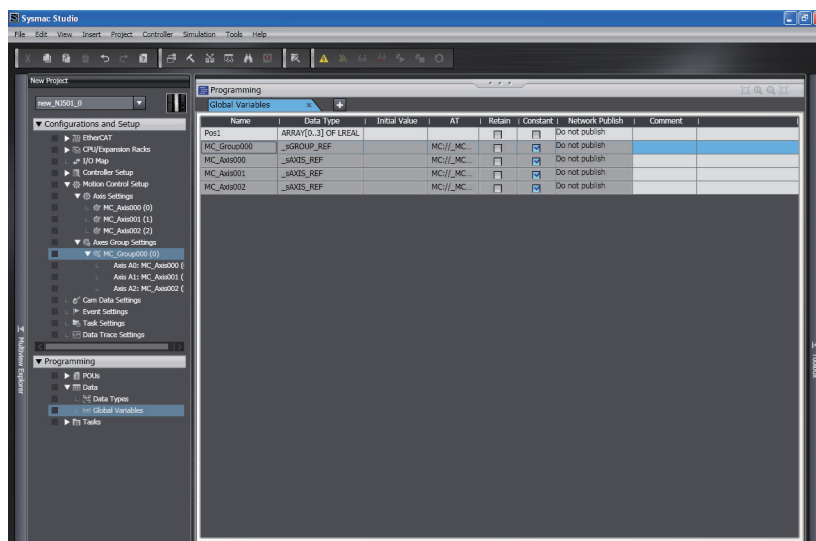

The following example shows assigning the target positions to *Pos1* with inline ST. In the figure, target positions (1000.0, 2000.0, 3000.0) are assigned to axes A0 to A2.

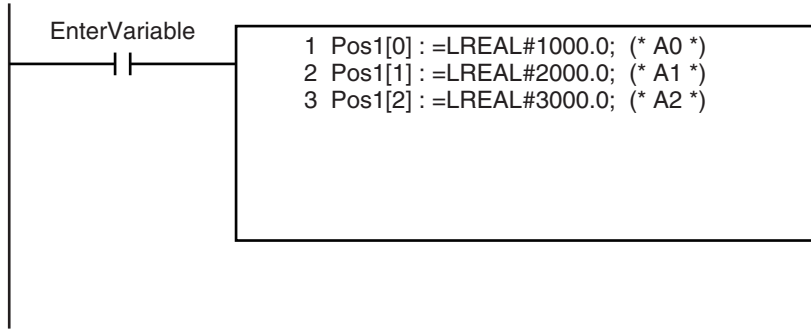

- If an axis with the Count Mode set to **Rotary Mode** is set as an interpolation axis and you specify absolute position, the target value will be the same as if *Direction* was set to **No direction specified**.

For details, refer to *Direction* on page 3-55.

● **Velocity (Target Velocity), Acceleration (Acceleration Rate), Deceleration (Deceleration Rate), and Jerk**

- Set *Velocity*, *Acceleration*, *Deceleration*, and *Jerk* to specify the interpolation velocity, acceleration rate, deceleration rate, and jerk for linear interpolation.
- Linear interpolation separates the interpolated motion into motion on each axis.

As an example, the following figure shows linear interpolation of 2 axes from point A to point B.

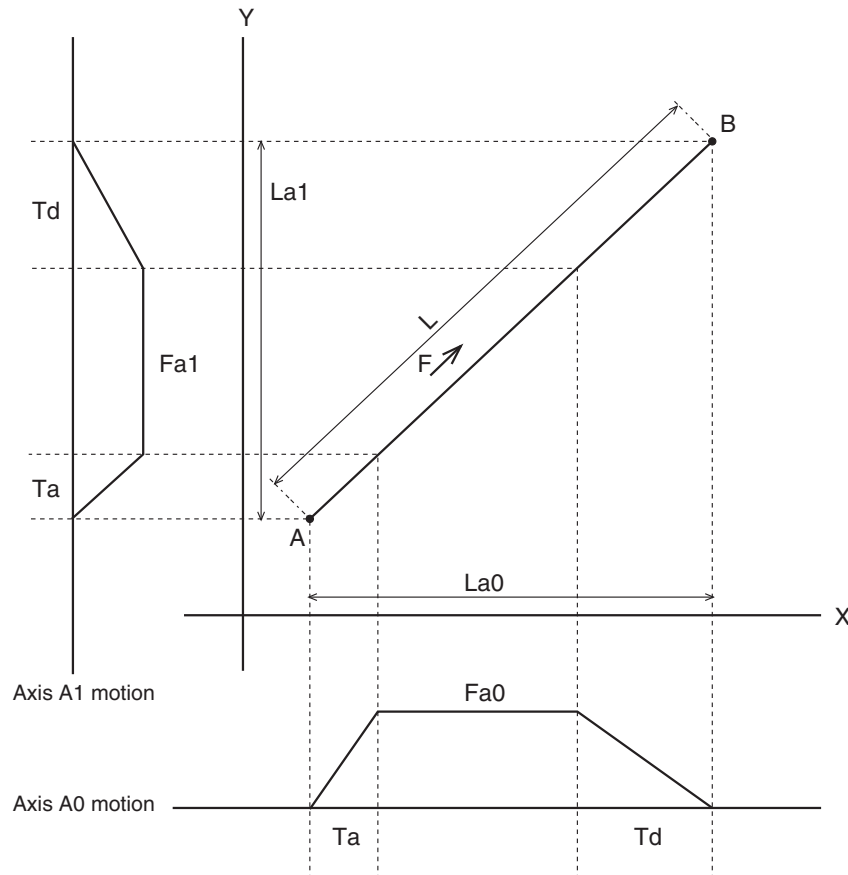

For linear interpolation of four axes, the interpolation velocity and travel distance of each axis determine the target velocities as shown below.

F: Specified interpolation feeding velocity



Fa0: Interpolation feeding velocity based on expansion of F to axis A0

Fa1: Interpolation feeding velocity based on expansion of F to axis A1

Fa2: Interpolation feeding velocity based on expansion of F to axis A2

Fa3: Interpolation feeding velocity based on expansion of F to axis A3

Ta: Interpolation acceleration time

Td: Interpolation deceleration time

L: Travel distance on the specified path

La0, La1, La2, and La3: Travel distances of axis A0, axis A1, axis A2, and axis A3.

L, Fa0, Fa1, Fa2, and Fa3 can be expressed with the following formulas.

$$Fa0 = F \times \frac{La0}{L}$$

$$Fa1 = F \times \frac{La1}{L}$$

$$Fa2 = F \times \frac{La2}{L}$$

$$Fa3 = F \times \frac{La3}{L}$$

$$L = \sqrt{La0^2 + La1^2 + La2^2 + La3^2}$$

### Velocity (Target Velocity)

- An interpolation velocity specification error will occur if *Velocity* (Target Velocity) is set to 0. All axes will stop if an axis in the specified axes group is in operation.
- If any of the calculated target velocities Fa0 to Fa3 for *Velocity* (Target Velocity) exceed the maximum velocity, the *Velocity* (Target Velocity) will be automatically adjusted so that one of the axes operates at the maximum velocity.

### Jerk

The relationships between *Acceleration* (Acceleration Rate), *Deceleration* (Deceleration Rate), and *Velocity* (Target Velocity) when *Jerk* is set to 0 and when it is set to any other value are shown below.

- *Jerk* Set to 0

The command value for the velocity is created with acceleration rate At and deceleration rate Dt.

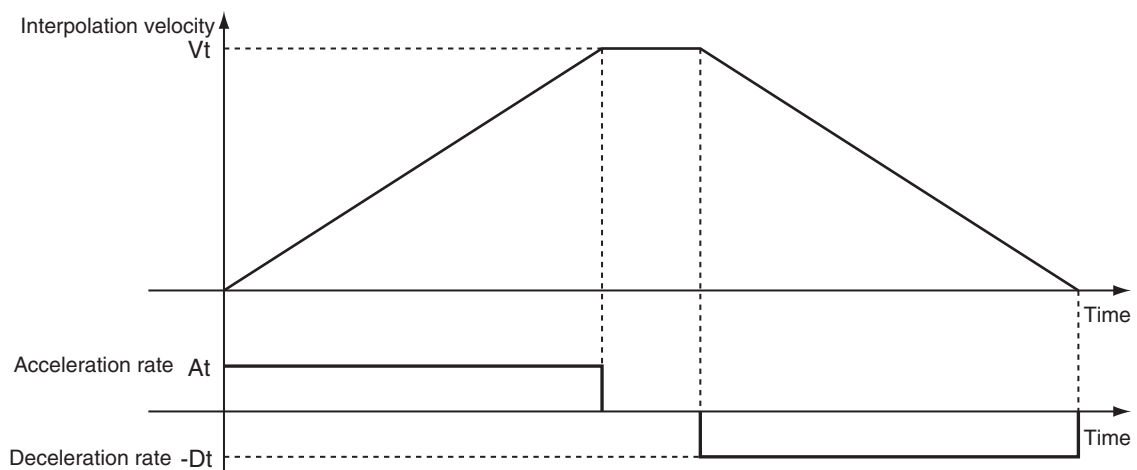

Vt: Specified interpolation velocity, At: Specified acceleration rate, Dt: Specified deceleration rate.

- Short Travel Distance When *Jerk* Is 0

The interpolation velocity will not reach the specified  $V_t$  (Target Velocity).

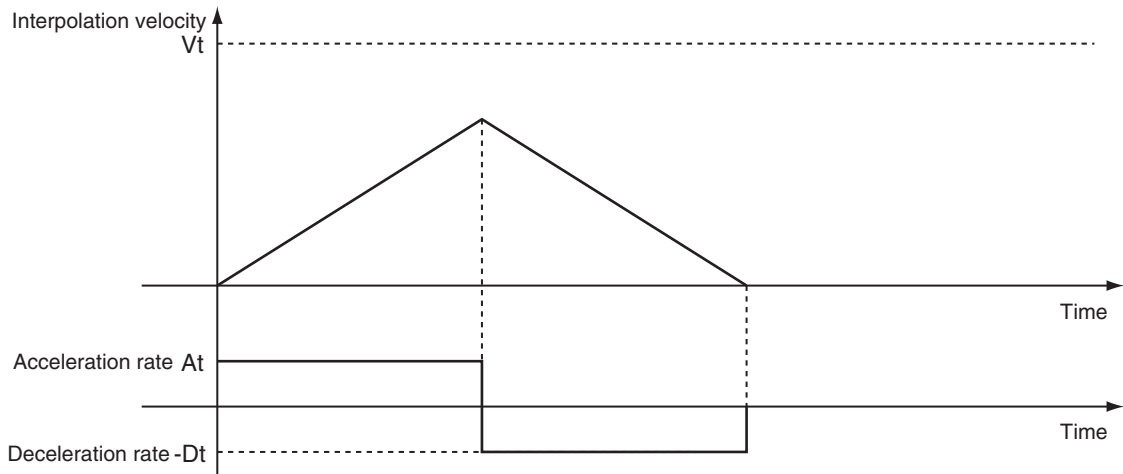

$V_t$ : Specified interpolation velocity,  $A_t$ : Specified acceleration rate,  $D_t$ : Specified deceleration rate.

- *Jerk* Set to Value Other Than 0

The command value for the velocity is created with  $A_t$  as the upper acceleration limit and  $D_t$  as the upper deceleration limit.

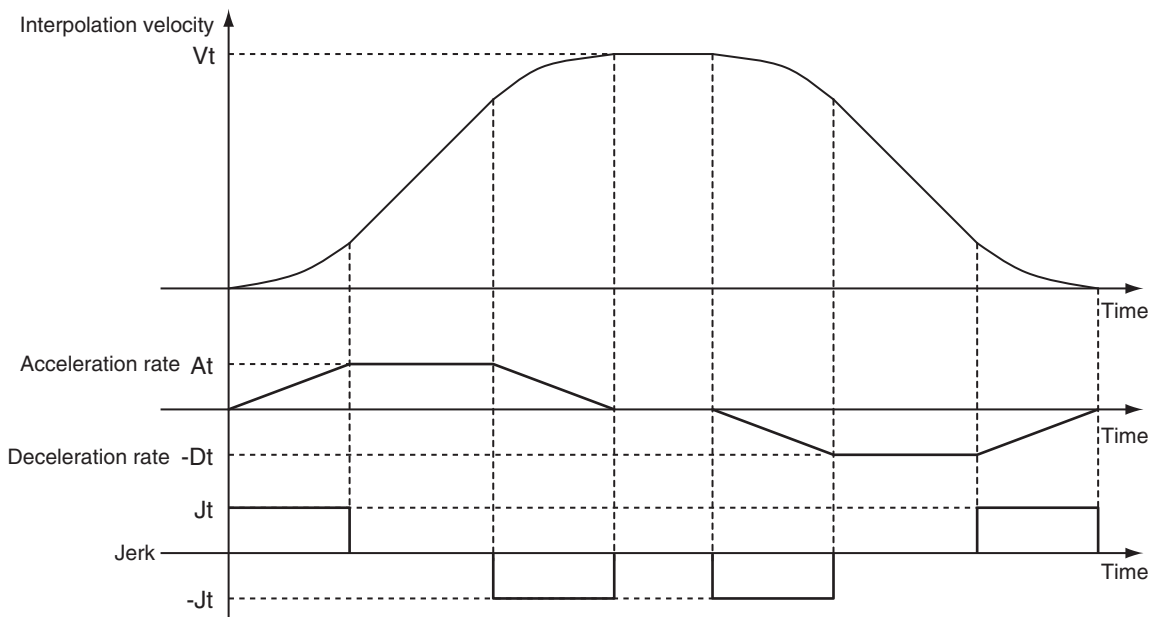

$V_t$ : Specified interpolation velocity,  $A_t$ : Specified acceleration rate,  $D_t$ : Specified deceleration rate,  $J_t$ : Specified jerk

- Short Travel Distance When *Jerk* Is Not 0

The interpolation velocity will not reach the specified  $V_t$  (Target Velocity).

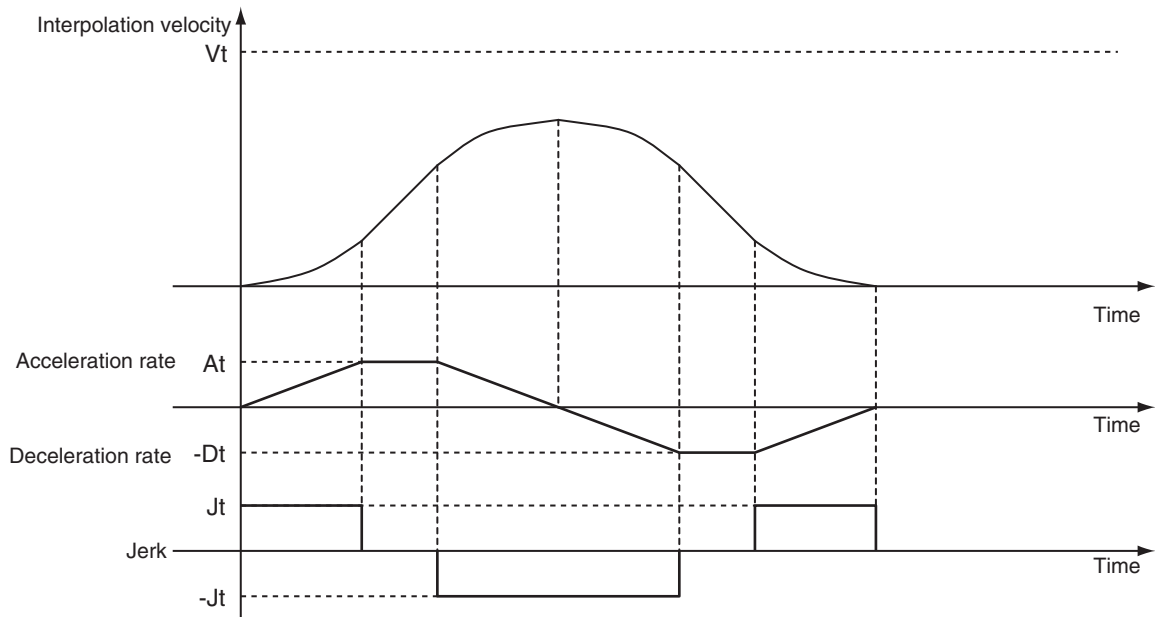

$V_t$ : Specified interpolation velocity,  $A_t$ : Specified acceleration rate,  $D_t$ : Specified deceleration rate,  $J_t$ : Specified jerk



#### Additional Information

- If 0 is specified for *Acceleration* (Acceleration Rate), the specified *Velocity* (Target Velocity) is used immediately.
- If 0 is specified for *Deceleration* (Deceleration Rate), the axis stops immediately. However, if the Buffer Mode is set to a blending mode, axis operation will change to the target velocity specified by the next operation without stopping. For details, refer to *BufferMode* (*Buffer Mode Selection*) on page 4-19.
- When the *Acceleration* (Acceleration Rate) or *Deceleration* (Deceleration Rate) is 0, the *Jerk* setting is disabled.

#### ● CoordSystem (Coordinate System)

- This variable specifies the coordinate system to use for linear interpolation.
- Only an axis coordinate system (ACS) consisting of two or more axes is supported.

#### ● BufferMode (Buffer Mode Selection)

- This variable specifies how to join the axis motions for this interpolation instruction and the previous interpolation instruction.
- There are the following six settings.

Buffer Mode Selection	Description
Aborting	Aborts the instruction being executed and switches to this instruction. If the direction of axis motion is reversed by switching instructions, the motion will be reversed according to the <b>Operation Selection at Reversing</b> axis parameter.
Buffered	Buffers this instruction and executes it automatically after the current instruction is completed.

Buffer Mode Selection	Description
Blending	Starts the buffered instruction at the velocity (transit velocity) at which the current instruction reaches the target position. The operation of the current instruction is changed so that the axes reach the target position at the transit velocity. There are four methods to specify the transit velocity. These are described below. You can also specify a Transition Mode as an option to the Blending Mode (see below).
Blending low	The lower of the target velocities of the current instruction and the buffered instruction is used as the transit velocity.
Blending previous	The target velocity of the current instruction is used as the transit velocity.
Blending next	The target velocity of the buffered instruction is used as the transit velocity.
Blending high	The higher of the target velocities of the current instruction and the buffered instruction is used as the transit velocity.

For details on *BufferMode* (Buffer Mode Selection), refer to the *NJ/NX-series CPU Unit Motion Control User's Manual (Cat. No. W507)*.

## ● TransitionMode

- This variable specifies how to combine the paths created by the previous interpolation operation and the next interpolation operation.
- Set the *TransitionMode* to either `_mcTMNone` (Transition Disabled) or `_mcTMCornerSuperimposed` (Superimpose Corners).
- *TransitionMode* is enabled when **Blending** is specified for *BufferMode*.
- An error will occur if you do not set *TransitionMode* to `_mcTMNone` (Transition Disabled) when **Blending** is not used.

### Transition Disabled

The path is given priority when creating the velocity command value, so velocity command values of the axes may change rapidly when switching from one operation to the next.

#### Operation Example

The *Velocity* (Target Velocity), *BufferMode*, and *TransitionMode* when transitioning from P1 to P2, and from P2 to P3 are shown below.

- Motion from P1 to P2: Velocity = F, BufferMode = Aborting, TransitionMode = `_mcTMNone` (Transition Disabled)
- Motion from P2 to P3: Velocity = F, BufferMode = Blending with next, TransitionMode = `_mcTMNone` (Transition Disabled)
- The motion starts from position P1 and goes through position P2. Linear interpolation is performed to position P3.
- The linear interpolation velocity F is maintained when passing position P2. Because of this, the velocity is discontinuous at position P2 as shown in the following figure.

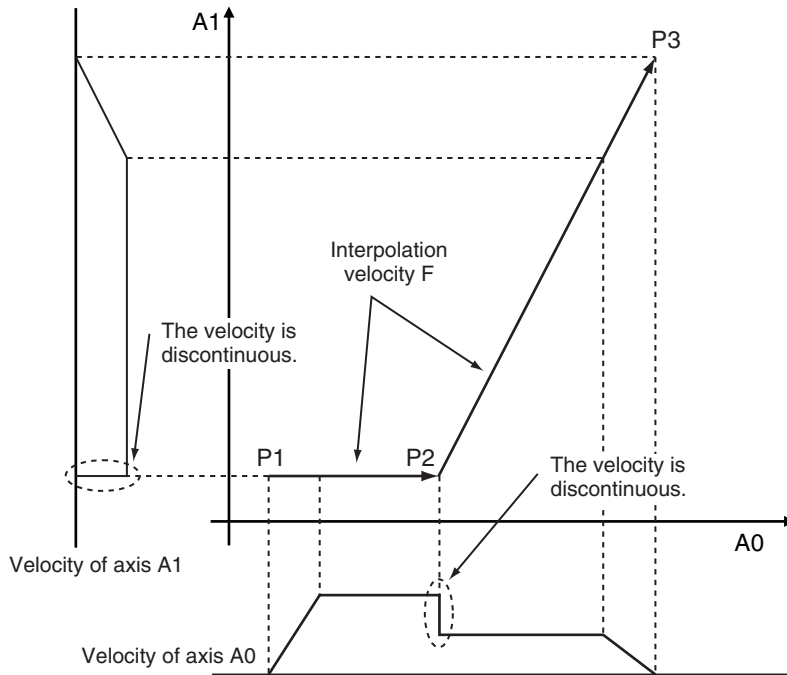

### Superimpose Corners

Use the superimpose corners specification when you want make the axes command velocities continuous.

#### Operation Example

*Velocity* (Target Velocity), *BufferMode*, and *TransitionMode* when transitioning from P1 to P2, and from P2 to P3 are shown below.

- Motion from P1 to P2: Velocity = F, BufferMode = Aborting, TransitionMode = `_mcTMNone` (Transition Disabled)
- Motion from P2 to P3: Velocity = F, BufferMode = Blending with next, TransitionMode = `_mcTMCornerSuperimposed` (Superimpose Corners)
- The motion starts from position P1 and passes near position P2. Linear interpolation is performed to position P3.
- To make the axes command velocities continuous, the deceleration range of the previous motion and the acceleration range of the current motion are combined to create the command velocity. For this reason, the acceleration time of the current motion is the same as the deceleration time of the previous motion.

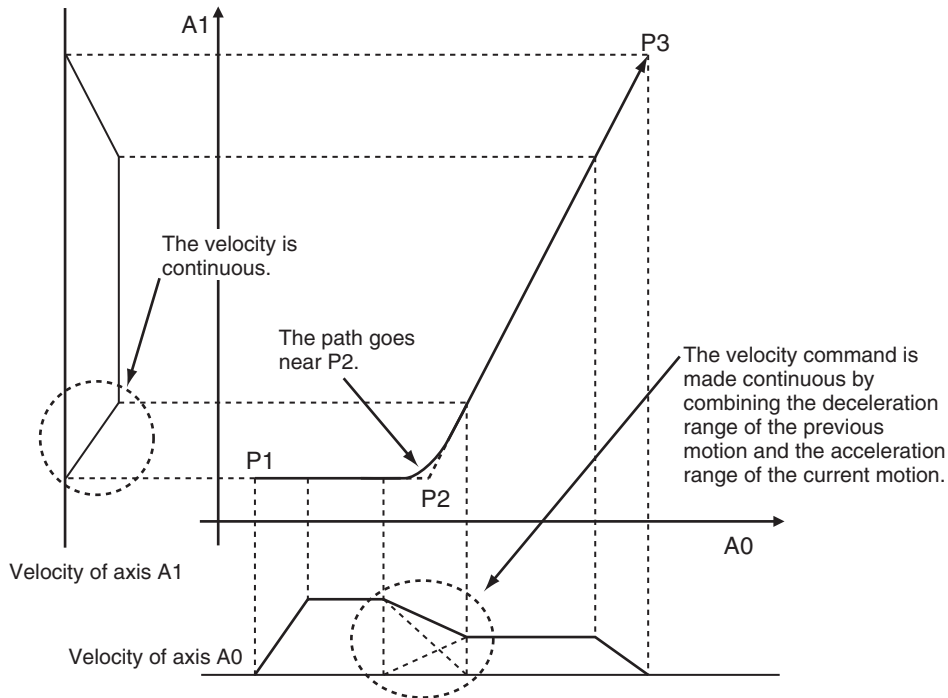

The combined path passes near P2.

The distance from P2 to the path is as below:

- It is longer when the interpolation velocity is faster or the deceleration rate of the previous instruction is smaller.
- It is shorter when the interpolation velocity is slower or the deceleration rate of the previous instruction is larger.



#### Additional Information

The *Jerk* settings are disabled in the region with superimposed corners.

## Re-execution of Motion Control Instructions

This instruction cannot be re-executed.

A Motion Control Instruction Re-execution Disabled error (error code: 543B hex) occurs if re-execution is attempted, and all axes in the linear interpolation motion stop.

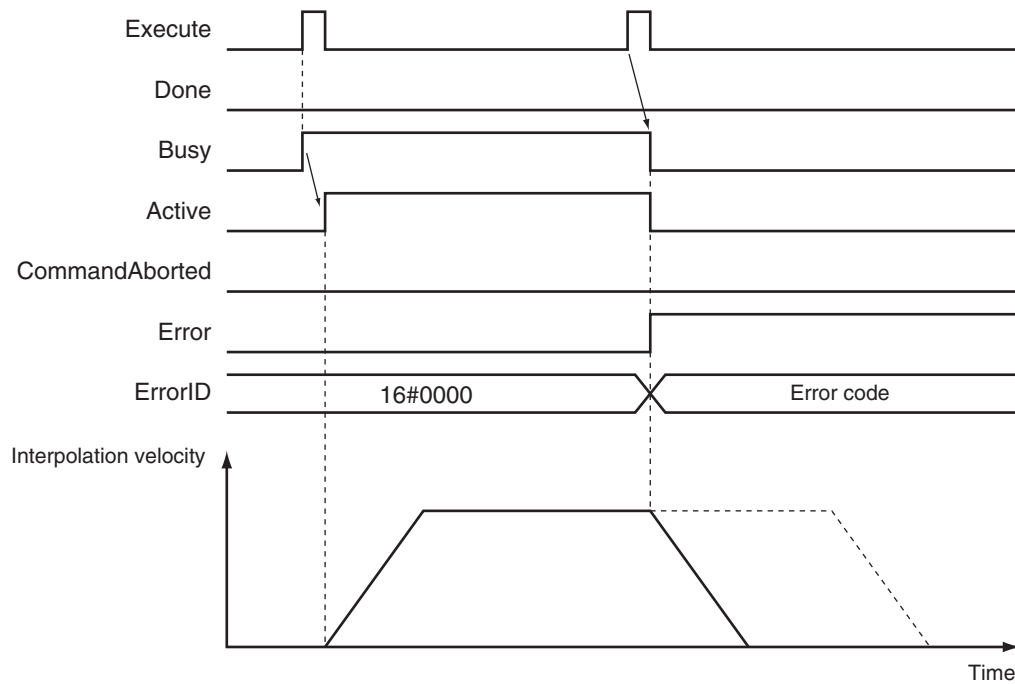

## Multi-execution of Motion Control Instructions

A restriction applies to the instructions that can be used while this instruction is in execution.

For details on multi-execution of motion control instructions, refer to the *NJ/NX-series CPU Unit Motion Control User's Manual (Cat. No. W507)*.

## Errors

If an error occurs during instruction execution, *Error* will change to TRUE.

You can find out the cause of the error by referring to the value output by *ErrorID* (Error Code).

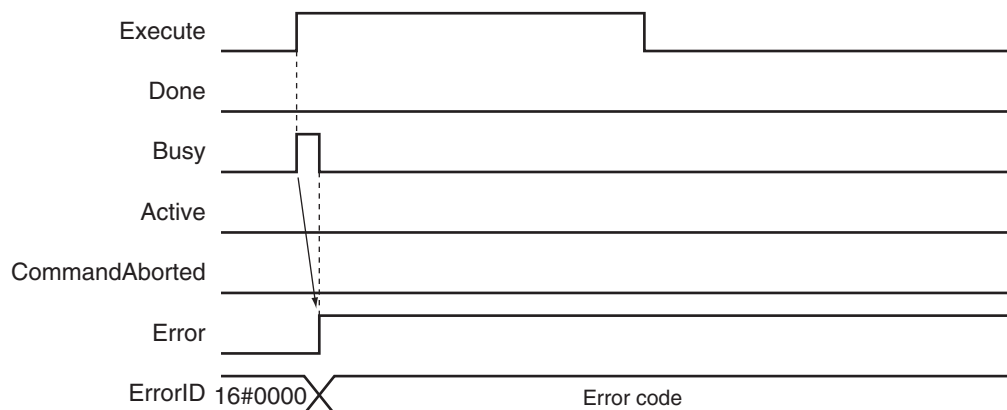

### ● Error Codes

Refer to the *NJ/NX-series Troubleshooting Manual (Cat. No. W503)* for instruction errors.

## Sample Programming

This section shows sample programming for linear interpolation with periodic multi-execution of instructions.

### Parameter Settings

The minimum settings required for this sample programming are given below.

#### ● Setting Axis Parameters

##### Axis Types

Axis	Axis Type
Axis 1	Servo axis
Axis 2	Servo axis

##### Count Modes

Axis	Count Mode
Axis 1	Linear Mode
Axis 2	Linear Mode

##### Units of Display

Axis	Unit of Display
Axis 1	mm
Axis 2	mm

#### ● Axes Group Parameter Settings

##### Axis Composition

Two axes are set.

##### Axis Selection

Axis 1 and axis 2 are set.

### Operation Example

The following is an example of operation that performs linear interpolation automatically and then returns to home and stops.

Linear interpolations (2) to (7) are executed with multi-execution of instructions while linear interpolation (1) is being executed. Set the *Buffer Mode Selection* to **Buffered**.

In this sample, multi-execution of instructions is performed for (2) to (7) if the *Active* (Controlling) output variable from linear interpolation (1) is TRUE. For multi-axes coordinated operation, multi-execution is possible for up to seven instructions.



## ● Operation Pattern

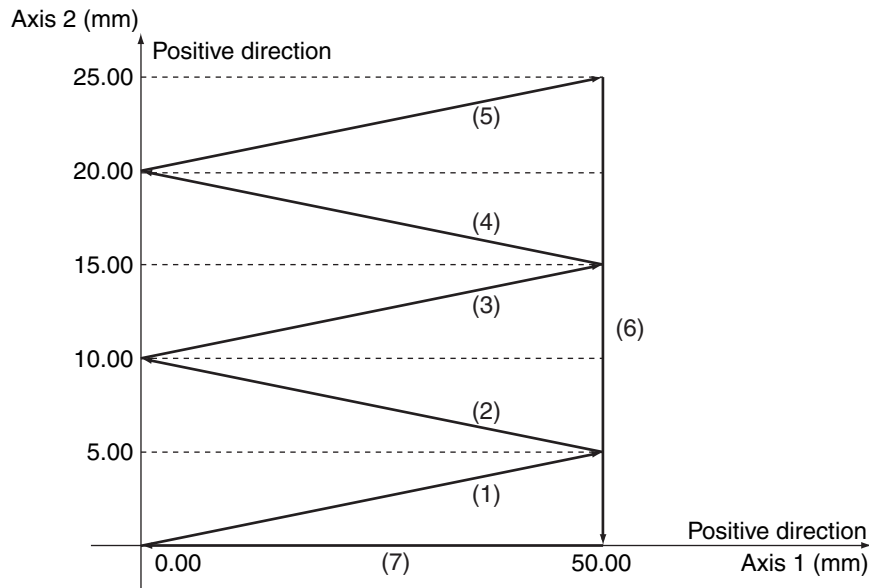

Positioning is performed using linear interpolations in the order (Axis1, Axis2) = (50.00 mm, 5.00 mm) → (0.00 mm, 10.00 mm) → (50.00 mm, 15.00 mm) → (0.00 mm, 20.00 mm) → (50.00 mm, 25.00 mm) → (50.00 mm, 0.00 mm) → (0.00 mm, 0.00 mm), then stop.

## Ladder Diagram

### ● Main Variables

Name	Data type	Default	Comment
MC_Group000	_sGROUP_REF	---	This is the Axes Group Variable for axes group 0.
MC_Group000.MFaultLvl.Active	BOOL	FALSE	TRUE while there is a minor fault level error for axes group 0.
MC_Group000.Status.Disabled	BOOL	FALSE	The value is TRUE when axes group 0 is disabled.
MC_Axis000	_sAXIS_REF	---	This is the Axis Variable for axis 1.
MC_Axis000.Details.Homed	BOOL	FALSE	TRUE when home is defined for axis 1.
MC_Axis000.MFaultLvl.Active	BOOL	FALSE	TRUE while there is a minor fault level error for axis 1.
MC_Axis001	_sAXIS_REF	---	This is the Axis Variable for axis 2.
MC_Axis001.Details.Homed	BOOL	FALSE	TRUE when home is defined for axis 2.
MC_Axis001.MFaultLvl.Active	BOOL	FALSE	TRUE while there is a minor fault level error for axis 2.
Pwr1_Status	BOOL	FALSE	This variable is assigned to the <i>Status</i> output variable from the PWR1 instance of the MC_Power instruction. This variable changes to TRUE when the Servo is turned ON.
Pwr2_Status	BOOL	FALSE	This variable is assigned to the <i>Status</i> output variable from the PWR2 instance of the MC_Power instruction. This variable changes to TRUE when the Servo is turned ON.

Name	Data type	Default	Comment
StartPg	BOOL	FALSE	The Servos for the axes in the axes group are turned ON if this variable is TRUE and Ether-CAT process data communications are established.
InitFlag	BOOL	FALSE	This variable indicates if it is necessary to set the input parameters. Input parameters are set when this variable is FALSE. When setting the input parameters is completed, this variable changes to TRUE.

● Sample Programming

If *StartPg* is TRUE, check that the Servo Drives for each axis are ready.

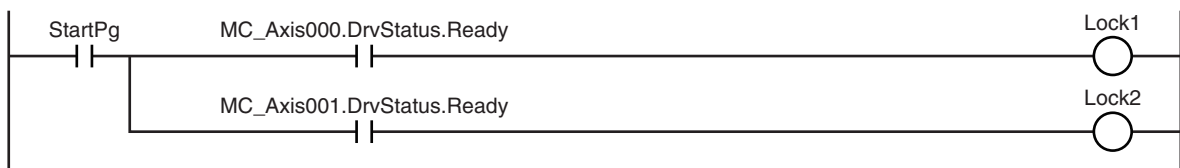

If the Servo Drives are ready, the Servos are turned ON for each axis.

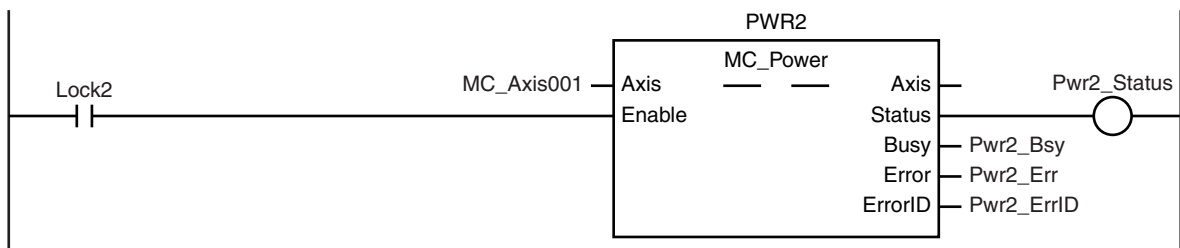
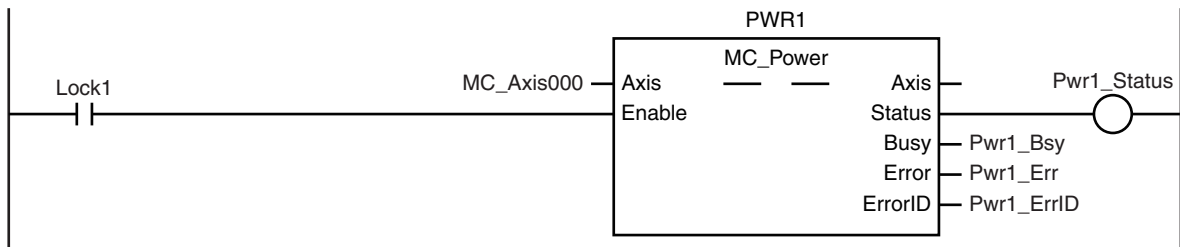

If a minor fault level error occurs for the axis composition, the error handler for the device (FaultHandler) is executed.

Program the FaultHandler according to the device.

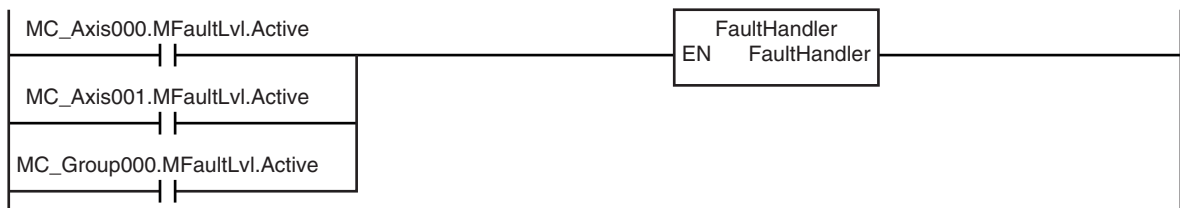

If the Servo is ON for axis 1 and home is not defined, the Home instruction is executed to define home.

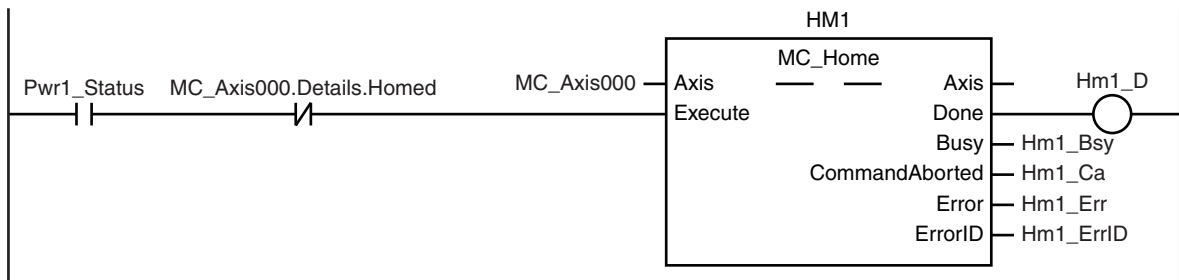

If the Servo is ON for axis 2 and home is not defined, the Home instruction is executed to define home.

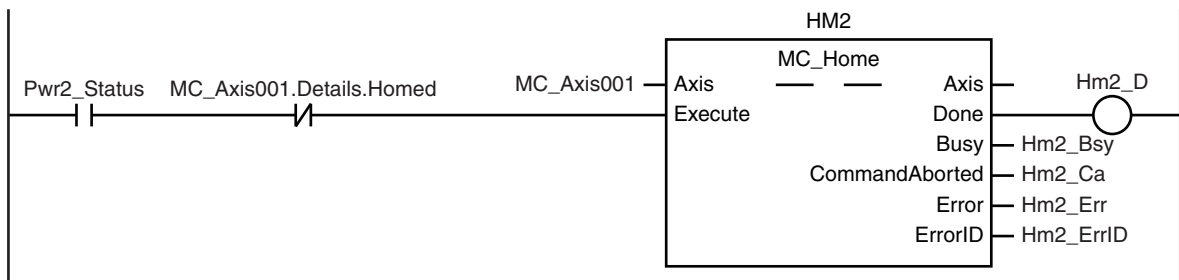

After home is defined for axis 1 and axis 2, the axes group is enabled.

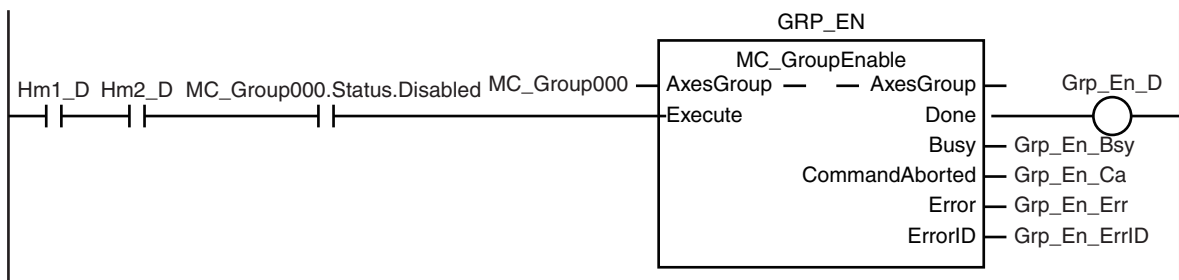

The parameters are set for linear interpolation.

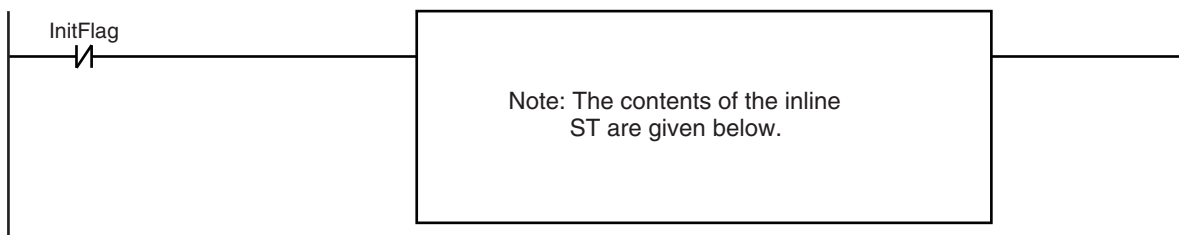

If the axes group is enabled, linear interpolation (1) is executed.

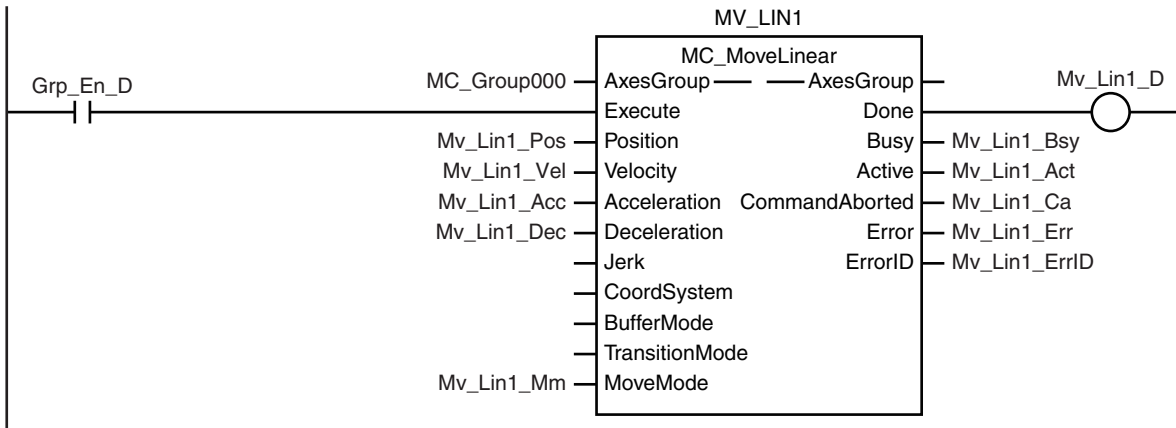

Linear interpolation (2) is executed with multi-execution of instructions after linear interpolation (1) is started.

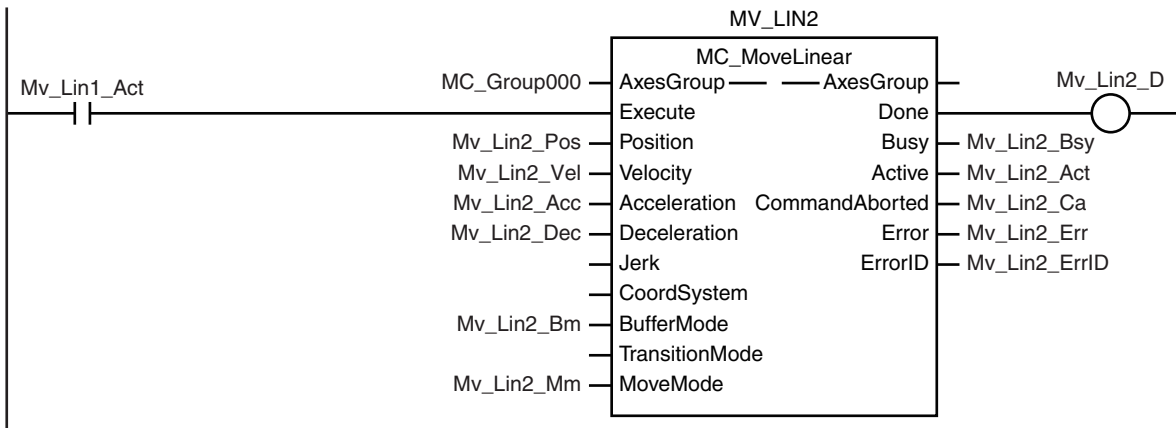

Linear interpolation (3) is executed with multi-execution of instructions after linear interpolation (1) is started.

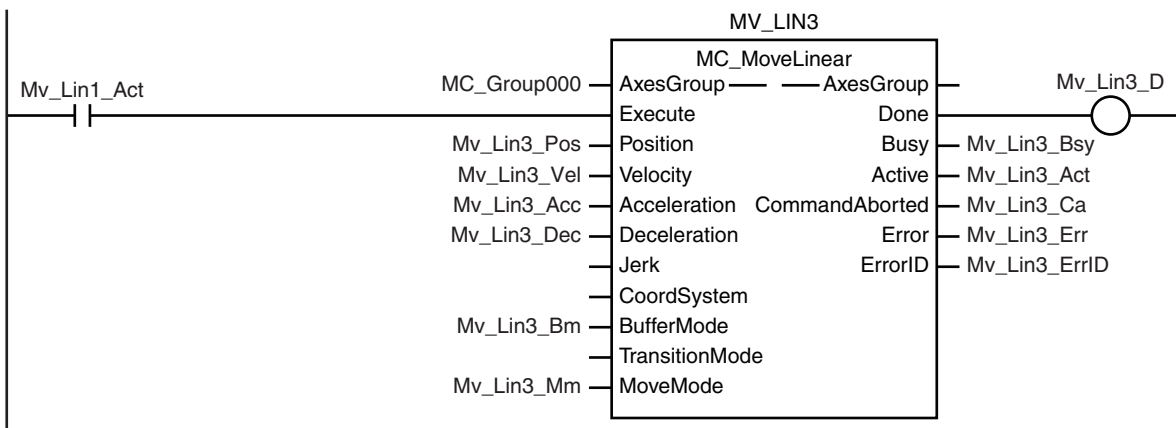

Linear interpolation (4) is executed with multi-execution of instructions after linear interpolation (1) is started.

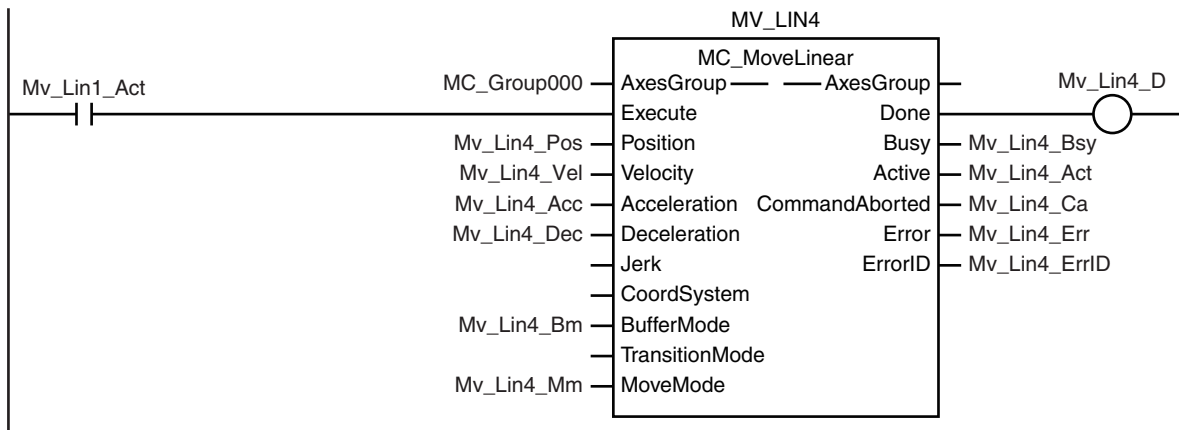

Linear interpolation (5) is executed with multi-execution of instructions after linear interpolation (1) is started.

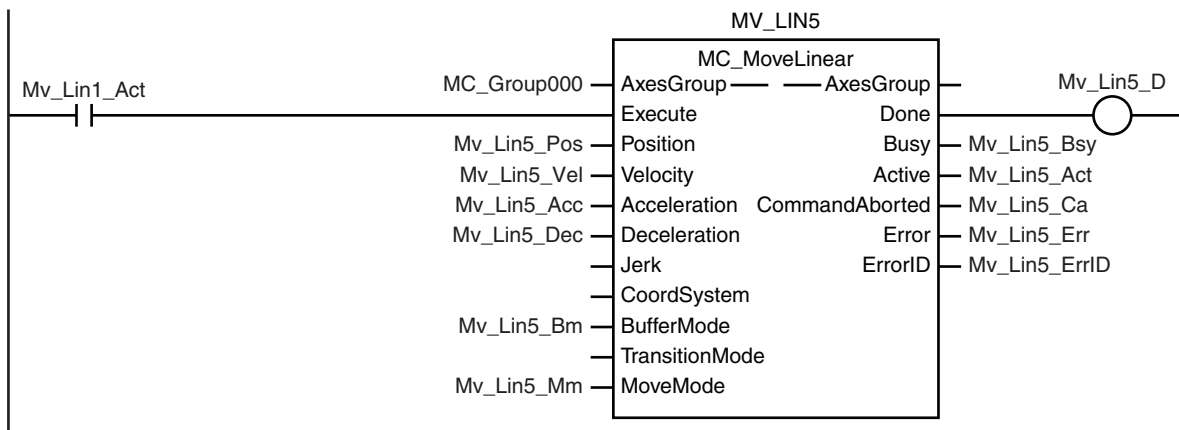

Linear interpolation (6) is executed with multi-execution of instructions after linear interpolation (1) is started.

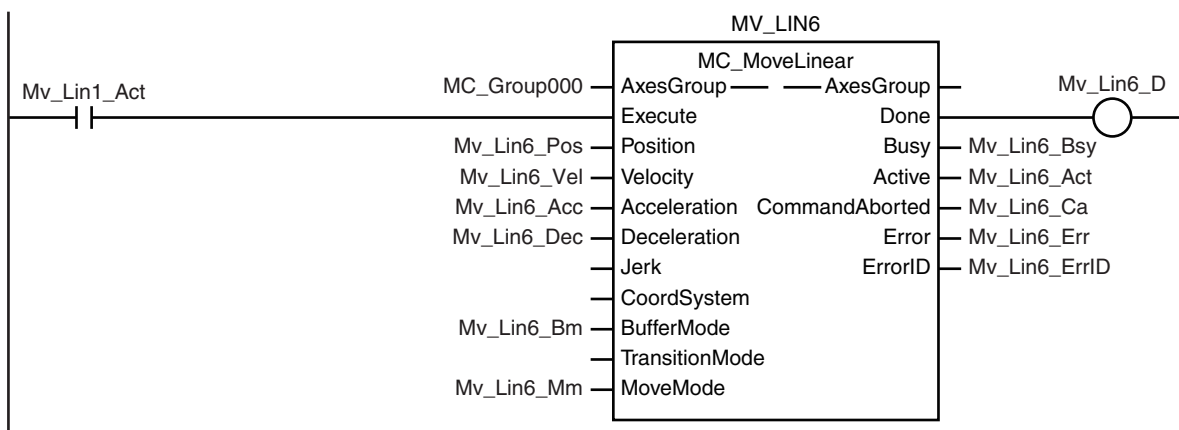

Linear interpolation (7) is executed with multi-execution of instructions after linear interpolation (1) is started.

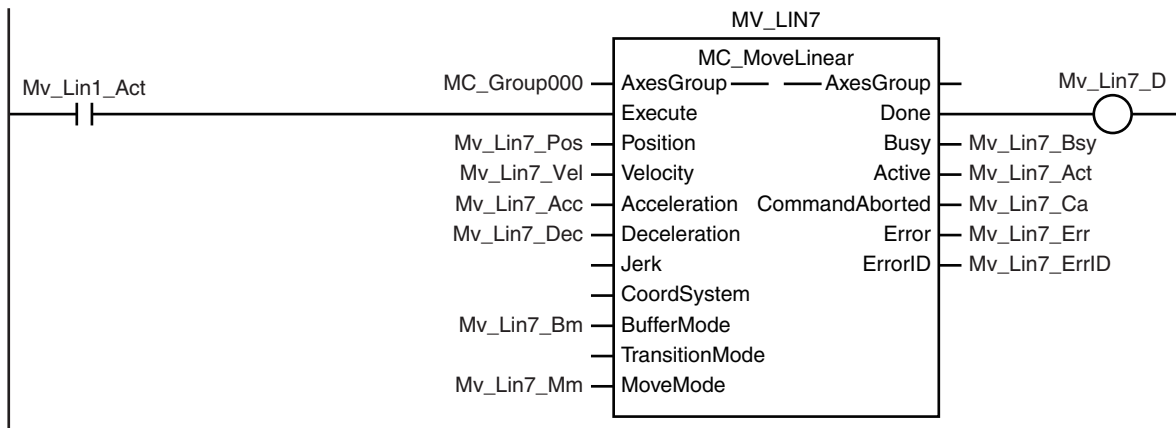

### Contents of Inline ST

```
// MV_LIN1 parameters
Mv_Lin1_Pos[0] := LREAL#50.0;
Mv_Lin1_Pos[1] := LREAL#5.0;
Mv_Lin1_Vel := LREAL#100.0;
Mv_Lin1_Acc := LREAL#100.0;
Mv_Lin1_Dec := LREAL#100.0;
Mv_Lin1_Mm := _eMC_MOVE_MODE#_mcAbsolute;

// MV_LIN2 parameters
Mv_Lin2_Pos[0] := LREAL#0.0;
Mv_Lin2_Pos[1] := LREAL#10.0;
Mv_Lin2_Vel := LREAL#100.0;
Mv_Lin2_Acc := LREAL#100.0;
Mv_Lin2_Dec := LREAL#100.0;
Mv_Lin2_Bm := _eMC_BUFFER_MODE#_mcBuffered;
Mv_Lin2_Mm := _eMC_MOVE_MODE#_mcAbsolute;

// MV_LIN3 parameters
Mv_Lin3_Pos[0] := LREAL#50.0;
Mv_Lin3_Pos[1] := LREAL#15.0;
Mv_Lin3_Vel := LREAL#100.0;
Mv_Lin3_Acc := LREAL#100.0;
Mv_Lin3_Dec := LREAL#100.0;
Mv_Lin3_Bm := _eMC_BUFFER_MODE#_mcBuffered;
Mv_Lin3_Mm := _eMC_MOVE_MODE#_mcAbsolute;

// MV_LIN4 parameters
Mv_Lin4_Pos[0] := LREAL#0.0;
Mv_Lin4_Pos[1] := LREAL#20.0;
Mv_Lin4_Vel := LREAL#100.0;
Mv_Lin4_Acc := LREAL#100.0;
Mv_Lin4_Dec := LREAL#100.0;
Mv_Lin4_Bm := _eMC_BUFFER_MODE#_mcBuffered;
```

```

Mv_Lin4_Mm := _eMC_MOVE_MODE#_mcAbsolute;

// MV_LIN5 parameters
Mv_Lin5_Pos[0] := LREAL#50.0;
Mv_Lin5_Pos[1] := LREAL#25.0;
Mv_Lin5_Vel := LREAL#100.0;
Mv_Lin5_Acc := LREAL#100.0;
Mv_Lin5_Dec := LREAL#100.0;
Mv_Lin5_Bm := _eMC_BUFFER_MODE#_mcBuffered;
Mv_Lin5_Mm := _eMC_MOVE_MODE#_mcAbsolute;

// MV_LIN6 parameters
Mv_Lin6_Pos[0] := LREAL#50.0;
Mv_Lin6_Pos[1] := LREAL#0.0;
Mv_Lin6_Vel := LREAL#100.0;
Mv_Lin6_Acc := LREAL#100.0;
Mv_Lin6_Dec := LREAL#100.0;
Mv_Lin6_Bm := _eMC_BUFFER_MODE#_mcBuffered;
Mv_Lin6_Mm := _eMC_MOVE_MODE#_mcAbsolute;

// MV_LIN7 parameters
Mv_Lin7_Pos[0] := LREAL#0.0;
Mv_Lin7_Pos[1] := LREAL#0.0;
Mv_Lin7_Vel := LREAL#100.0;
Mv_Lin7_Acc := LREAL#100.0;
Mv_Lin7_Dec := LREAL#100.0;
Mv_Lin7_Bm := _eMC_BUFFER_MODE#_mcBuffered;
Mv_Lin7_Mm := _eMC_MOVE_MODE#_mcAbsolute;

// InitFlag is changed to TRUE after input parameters are set.
InitFlag := TRUE;

```

## Structured Text (ST)

### ● Main Variables

Name	Data type	Default	Comment
MC_Group000	_sGROUP_REF	---	This is the Axes Group Variable for axes group 0.
MC_Group000.MFaultLvl.Active	BOOL	FALSE	TRUE while there is a minor fault level error for axes group 0.
MC_Group000.Status.Disabled	BOOL	FALSE	The value is TRUE when axes group 0 is disabled.
MC_Axis000	_sAXIS_REF	---	This is the Axis Variable for axis 1.
MC_Axis000.Details.Homed	BOOL	FALSE	TRUE when home is defined for axis 1.
MC_Axis000.MFaultLvl.Active	BOOL	FALSE	TRUE while there is a minor fault level error for axis 1.

Name	Data type	Default	Comment
MC_Axis001	_sAXIS_REF	---	This is the Axis Variable for axis 2.
MC_Axis001.Details.Homed	BOOL	FALSE	TRUE when home is defined for axis 2.
MC_Axis001.MFaultLvl.Active	BOOL	FALSE	TRUE while there is a minor fault level error for axis 2.
Pwr1_Status	BOOL	FALSE	This variable is assigned to the <i>Status</i> output variable from the PWR1 instance of the MC_Power instruction. This variable changes to TRUE when the Servo is turned ON.
Pwr2_Status	BOOL	FALSE	This variable is assigned to the <i>Status</i> output variable from the PWR2 instance of the MC_Power instruction. This variable changes to TRUE when the Servo is turned ON.
StartPg	BOOL	FALSE	The Servos for the axes in the axes group are turned ON if this variable is TRUE and Ether-CAT process data communications are established.
InitFlag	BOOL	FALSE	This variable indicates if it is necessary to set the input parameters. Input parameters are set when this variable is FALSE. When setting the input parameters is completed, this variable changes to TRUE.

## ● Sample Programming

```
// Processing when input parameters are not set
IF InitFlag=FALSE THEN

    // MV_LIN1 parameters
    Mv_Lin1_Pos[0] := LREAL#50.0;
    Mv_Lin1_Pos[1] := LREAL#5.0;
    Mv_Lin1_Vel := LREAL#100.0;
    Mv_Lin1_Acc := LREAL#100.0;
    Mv_Lin1_Dec := LREAL#100.0;
    Mv_Lin1_Mm := _eMC_MOVE_MODE#_mcAbsolute;

    // MV_LIN2 parameters
    Mv_Lin2_Pos[0] := LREAL#0.0;
    Mv_Lin2_Pos[1] := LREAL#10.0;
    Mv_Lin2_Vel := LREAL#100.0;
    Mv_Lin2_Acc := LREAL#100.0;
    Mv_Lin2_Dec := LREAL#100.0;
    Mv_Lin2_Bm := _eMC_BUFFER_MODE#_mcBuffered;
    Mv_Lin2_Mm := _eMC_MOVE_MODE#_mcAbsolute;

    // MV_LIN3 parameters
    Mv_Lin3_Pos[0] := LREAL#50.0;
    Mv_Lin3_Pos[1] := LREAL#15.0;
    Mv_Lin3_Vel := LREAL#100.0;
    Mv_Lin3_Acc := LREAL#100.0;
```



```

Mv_Lin3_Dec := LREAL#100.0;
Mv_Lin3_Bm := _eMC_BUFFER_MODE#_mcBuffered;
Mv_Lin3_Mm := _eMC_MOVE_MODE#_mcAbsolute;

// MV_LIN4 parameters
Mv_Lin4_Pos[0] := LREAL#0.0;
Mv_Lin4_Pos[1] := LREAL#20.0;
Mv_Lin4_Vel := LREAL#100.0;
Mv_Lin4_Acc := LREAL#100.0;
Mv_Lin4_Dec := LREAL#100.0;
Mv_Lin4_Bm := _eMC_BUFFER_MODE#_mcBuffered;
Mv_Lin4_Mm := _eMC_MOVE_MODE#_mcAbsolute;

// MV_LIN5 parameters
Mv_Lin5_Pos[0] := LREAL#50.0;
Mv_Lin5_Pos[1] := LREAL#25.0;
Mv_Lin5_Vel := LREAL#100.0;
Mv_Lin5_Acc := LREAL#100.0;
Mv_Lin5_Dec := LREAL#100.0;
Mv_Lin5_Bm := _eMC_BUFFER_MODE#_mcBuffered;
Mv_Lin5_Mm := _eMC_MOVE_MODE#_mcAbsolute;

// MV_LIN6 parameters
Mv_Lin6_Pos[0] := LREAL#50.0;
Mv_Lin6_Pos[1] := LREAL#0.0;
Mv_Lin6_Vel := LREAL#100.0;
Mv_Lin6_Acc := LREAL#100.0;
Mv_Lin6_Dec := LREAL#100.0;
Mv_Lin6_Bm := _eMC_BUFFER_MODE#_mcBuffered;
Mv_Lin6_Mm := _eMC_MOVE_MODE#_mcAbsolute;

// MV_LIN7 parameters
Mv_Lin7_Pos[0] := LREAL#0.0;
Mv_Lin7_Pos[1] := LREAL#0.0;
Mv_Lin7_Vel := LREAL#100.0;
Mv_Lin7_Acc := LREAL#100.0;
Mv_Lin7_Dec := LREAL#100.0;
Mv_Lin7_Bm := _eMC_BUFFER_MODE#_mcBuffered;
Mv_Lin7_Mm := _eMC_MOVE_MODE#_mcAbsolute;

// Change InitFlag to TRUE after setting the input parameters.
InitFlag := TRUE;

END_IF;

// If StartPg is TRUE and the Servo Drive is ready, the Servo for axis 1 is turned
ON.

```

```

// If the Servo Drive is not ready, the Servo is turned OFF.
IF (StartPg=TRUE)
  AND (MC_Axis000.DrvStatus.Ready=TRUE) THEN
    Pwr1_En:=TRUE; // Turn ON the Servo for axis 1.
ELSE
  Pwr1_En:=FALSE; // Turn OFF the Servo for axis 1.
END_IF;

// If StartPg is TRUE and the Servo Drive is ready, the Servo for axis 2 is turned
ON.
// If the Servo Drive is not ready, the Servo is turned OFF.
IF (StartPg=TRUE)
  AND (MC_Axis001.DrvStatus.Ready=TRUE) THEN
    Pwr2_En:=TRUE; // Turn ON the Servo for axis 2.
ELSE
  Pwr2_En:=FALSE; // Turn OFF the Servo for axis 2.
END_IF;

// Processing for a minor fault level error
// Program the FaultHandler according to the device.
IF (MC_Axis000.MFaultLvl.Active=TRUE) OR (MC_Axis001.MFaultLvl.Active=TRUE)
  OR (MC_Group000.MFaultLvl.Active=TRUE) THEN
  FaultHandler();
END_IF;

// If the Servo is ON for axis 1 and home is not defined, the Home instruction is e
xecuted.
IF (Pwr1_Status=TRUE) AND (MC_Axis000.Details.Homed=FALSE) THEN
  Hm1_Ex:=TRUE;
END_IF;

// If the Servo is ON for axis 2 and home is not defined, the Home instruction is e
xecuted.
IF (Pwr2_Status=TRUE) AND (MC_Axis001.Details.Homed=FALSE) THEN
  Hm2_Ex:=TRUE;
END_IF;

// If axes group 0 is disabled while home is defined for axis 1 and axis 2, it is e
nabled.
IF (Hm1_D=TRUE) AND (Hm2_D=TRUE) AND (MC_Group000.Status.Disabled=TRUE) THEN
  Grp_En_Ex:= TRUE;
END_IF;

// After the MC_GroupEnable (Enable Axes Group) instruction is completed, linear in
terpolation (1) is executed.
IF Grp_En_D=TRUE THEN
  Mv_Lin1_Ex:=TRUE;

```

```

END_IF;

// Linear interpolations (2) to (7) are executed with multi-execution of instructions while the Active output variable for linear interpolation (1) is TRUE.
IF Mv_Lin1_Act=TRUE THEN
    Mv_Lin2_Ex:=TRUE;
    Mv_Lin3_Ex:=TRUE;
    Mv_Lin4_Ex:=TRUE;
    Mv_Lin5_Ex:=TRUE;
    Mv_Lin6_Ex:=TRUE;
    Mv_Lin7_Ex:=TRUE;
END_IF;

// MC_Power for axis 1
PWR1 (
    Axis := MC_Axis000,
    Enable := Pwr1_En,
    Status => Pwr1_Status,
    Busy => Pwr1_Bsy,
    Error => Pwr1_Err,
    ErrorID => Pwr1_ErrID
);

// MC_Power for axis 2
PWR2 (
    Axis := MC_Axis001,
    Enable := Pwr2_En,
    Status => Pwr2_Status,
    Busy => Pwr2_Bsy,
    Error => Pwr2_Err,
    ErrorID => Pwr2_ErrID
);

// MC_Home for axis 1
HM1 (
    Axis := MC_Axis000,
    Execute := Hm1_Ex,
    Done => Hm1_D,
    Busy => Hm1_Bsy,
    CommandAborted => Hm1_Ca,
    Error => Hm1_Err,
    ErrorID => Hm1_ErrID
);

// MC_Home for axis 2
HM2 (
    Axis := MC_Axis001,

```

```

Execute := Hm2_Ex,
Done => Hm2_D,
Busy => Hm2_Bsy,
CommandAborted => Hm2_Ca,
Error => Hm2_Err,
ErrorID => Hm2_ErrID
);

// Axes group 0 is enabled.
GRP_EN(
  AxesGroup := MC_Group000,
  Execute := Grp_En_Ex,
  Done => Grp_En_D,
  Busy => Grp_En_Bsy,
  CommandAborted => Grp_En_Ca,
  Error => Grp_En_Err,
  ErrorID => Grp_En_ErrID
);

// Linear interpolation (1)
MV_LIN1(
  AxesGroup := MC_Group000,
  Execute := Mv_Lin1_Ex,
  Position := Mv_Lin1_Pos,
  Velocity := Mv_Lin1_Vel,
  Acceleration := Mv_Lin1_Acc,
  Deceleration := Mv_Lin1_Dec,
  MoveMode := Mv_Lin1_Mm,
  Done => Mv_Lin1_D,
  Busy => Mv_Lin1_Bsy,
  Active => Mv_Lin1_Act,
  CommandAborted => Mv_Lin1_Ca,
  Error => Mv_Lin1_Err,
  ErrorID => Mv_Lin1_ErrID
);

// Linear interpolation (2)
MV_LIN2(
  AxesGroup := MC_Group000,
  Execute := Mv_Lin2_Ex,
  Position := Mv_Lin2_Pos,
  Velocity := Mv_Lin2_Vel,
  Acceleration := Mv_Lin2_Acc,
  Deceleration := Mv_Lin2_Dec,
  BufferMode := Mv_Lin2_Bm,
  MoveMode := Mv_Lin2_Mm,
  Done => Mv_Lin2_D,

```

```

    Busy => Mv_Lin2_Bsy,
    Active => Mv_Lin2_Act,
    CommandAborted => Mv_Lin2_Ca,
    Error => Mv_Lin2_Err,
    ErrorID => Mv_Lin2_ErrID
);

// Linear interpolation (3)
MV_LIN3(
    AxesGroup := MC_Group000,
    Execute := Mv_Lin3_Ex,
    Position := Mv_Lin3_Pos,
    Velocity := Mv_Lin3_Vel,
    Acceleration := Mv_Lin3_Acc,
    Deceleration := Mv_Lin3_Dec,
    BufferMode := Mv_Lin3_Bm,
    MoveMode := Mv_Lin3_Mm,
    Done => Mv_Lin3_D,
    Busy => Mv_Lin3_Bsy,
    Active => Mv_Lin3_Act,
    CommandAborted => Mv_Lin3_Ca,
    Error => Mv_Lin3_Err,
    ErrorID => Mv_Lin3_ErrID
);

// Linear interpolation (4)
MV_LIN4(
    AxesGroup := MC_Group000,
    Execute := Mv_Lin4_Ex,
    Position := Mv_Lin4_Pos,
    Velocity := Mv_Lin4_Vel,
    Acceleration := Mv_Lin4_Acc,
    Deceleration := Mv_Lin4_Dec,
    BufferMode := Mv_Lin4_Bm,
    MoveMode := Mv_Lin4_Mm,
    Done => Mv_Lin4_D,
    Busy => Mv_Lin4_Bsy,
    Active => Mv_Lin4_Act,
    CommandAborted => Mv_Lin4_Ca,
    Error => Mv_Lin4_Err,
    ErrorID => Mv_Lin4_ErrID
);

// Linear interpolation (5)
MV_LIN5(
    AxesGroup := MC_Group000,
    Execute := Mv_Lin5_Ex,

```

```

    Position := Mv_Lin5_Pos,
    Velocity := Mv_Lin5_Vel,
    Acceleration := Mv_Lin5_Acc,
    Deceleration := Mv_Lin5_Dec,
    BufferMode := Mv_Lin5_Bm,
    MoveMode := Mv_Lin5_Mm,
    Done => Mv_Lin5_D,
    Busy => Mv_Lin5_Bsy,
    Active => Mv_Lin5_Act,
    CommandAborted => Mv_Lin5_Ca,
    Error => Mv_Lin5_Err,
    ErrorID => Mv_Lin5_ErrID
);

// Linear interpolation (6)
MV_LIN6(
    AxesGroup := MC_Group000,
    Execute := Mv_Lin6_Ex,
    Position := Mv_Lin6_Pos,
    Velocity := Mv_Lin6_Vel,
    Acceleration := Mv_Lin6_Acc,
    Deceleration := Mv_Lin6_Dec,
    BufferMode := Mv_Lin6_Bm,
    MoveMode := Mv_Lin6_Mm,
    Done => Mv_Lin6_D,
    Busy => Mv_Lin6_Bsy,
    Active => Mv_Lin6_Act,
    CommandAborted => Mv_Lin6_Ca,
    Error => Mv_Lin6_Err,
    ErrorID => Mv_Lin6_ErrID
);

// Linear interpolation (7)
MV_LIN7(
    AxesGroup := MC_Group000,
    Execute := Mv_Lin7_Ex,
    Position := Mv_Lin7_Pos,
    Velocity := Mv_Lin7_Vel,
    Acceleration := Mv_Lin7_Acc,
    Deceleration := Mv_Lin7_Dec,
    BufferMode := Mv_Lin7_Bm,
    MoveMode := Mv_Lin7_Mm,
    Done => Mv_Lin7_D,
    Busy => Mv_Lin7_Bsy,
    Active => Mv_Lin7_Act,
    CommandAborted => Mv_Lin7_Ca,
    Error => Mv_Lin7_Err,

```

```
ErrorID => Mv_Lin7_ErrID  
);
```

# MC\_MoveLinearAbsolute

The MC\_MoveLinearAbsolute instruction performs linear interpolation for a specified absolute position.

Instruction	Name	FB/ FUN	Graphic expression	ST expression
MC_MoveLinearAbsolute	Absolute Linear Interpolation	FB		<pre>MC_MoveLinearAbsolute_instance (   AxesGroup :=parameter,   Execute :=parameter,   Position :=parameter,   Velocity :=parameter,   Acceleration :=parameter,   Deceleration :=parameter,   Jerk :=parameter,   CoordSystem :=parameter,   BufferMode :=parameter,   TransitionMode :=parameter,   Done =&gt;parameter,   Busy =&gt;parameter,   Active =&gt;parameter,   CommandAborted =&gt;parameter,   Error =&gt;parameter,   ErrorID =&gt;parameter );</pre>

## Variables

### Input Variables

Name	Meaning	Data type	Valid range	Default	Description
Execute	Execute	BOOL	TRUE or FALSE	FALSE	The instruction is executed when the value of this variable changes to TRUE.
Position	Target Position	ARRAY [0..3] OF LREAL	Negative number, positive number, or 0	0	Specify the target position for linear interpolation. The unit is command units. *1
Velocity*2	Target Velocity	LREAL	Positive number	0	Specify the target velocity. The unit is command units/s. *1
Acceleration	Acceleration Rate	LREAL	Non-negative number	0	Specify the acceleration rate. The unit is command units/s <sup>2</sup> . *1
Deceleration	Deceleration Rate	LREAL	Non-negative number	0	Specify the deceleration rate. The unit is command units/s <sup>2</sup> . *1
Jerk	Jerk	LREAL	Non-negative number	0	Specify the jerk. The unit is command units/s <sup>3</sup> . *1



Name	Meaning	Data type	Valid range	Default	Description
CoordSystem	Coordinate System	_eMC_COORD_SYSTEM	0: _mcACS	0*3	Specify the coordinate system. 0: Axis coordinate system (ACS)
BufferMode	Buffer Mode Selection	_eMC_BUFFER_MODE	0: _mcAborting 1: _mcBuffered 2: _mcBlendingLow 3: _mcBlendingPrevious 4: _mcBlendingNext 5: _mcBlendingHigh	0*3	Specify the behavior when executing more than one motion instruction. 0: Aborting 1: Buffered 2: Blending low 3: Blending previous 4: Blending next 5: Blending high
Transition-Mode	Transition Mode	_eMC_TRANSITION_MODE	0: _mcTMNone 10: _mcTMCornerSuperimposed	0*3	Specify the path of motion. 0: Transition disabled 10: Superimpose corners

- \*1. Refer to *Unit Conversion Settings* in the *NJ/NX-series CPU Unit Motion Control User's Manual (Cat. No. W507)* for information on command units.
- \*2. Always set the target velocity. If the axes are moved without setting a target velocity, an error will occur.
- \*3. The default value for an enumeration variable is actually not the number, but the enumerator.

## Output Variables

Name	Meaning	Data type	Valid range	Description
Done	Done	BOOL	TRUE or FALSE	TRUE when the instruction is completed.
Busy	Executing	BOOL	TRUE or FALSE	TRUE when the instruction is acknowledged.
Active	Controlling	BOOL	TRUE or FALSE	TRUE when the axis is being controlled.
CommandAborted	Command Aborted	BOOL	TRUE or FALSE	TRUE when the instruction is aborted.
Error	Error	BOOL	TRUE or FALSE	TRUE while there is an error.
ErrorID	Error Code	WORD	*1	Contains the error code when an error occurs. A value of 16#0000 indicates normal execution.

- \*1. The upper four digits of the event code give the error code for ErrorID. Refer to the *NJ/NX-series Troubleshooting Manual (Cat. No. W503)* for the event codes.

### ● Output Variable Update Timing

Name	Timing for changing to TRUE	Timing for changing to FALSE
Done	When positioning is completed.	<ul style="list-style-type: none"> <li>When <i>Execute</i> is TRUE and changes to FALSE.</li> <li>After one period when <i>Execute</i> is FALSE.</li> </ul>
Busy	When <i>Execute</i> changes to TRUE.	<ul style="list-style-type: none"> <li>When <i>Done</i> changes to TRUE.</li> <li>When <i>Error</i> changes to TRUE.</li> <li>When <i>CommandAborted</i> changes to TRUE.</li> </ul>

Name	Timing for changing to TRUE	Timing for changing to FALSE
Active	When the axes move.	<ul style="list-style-type: none"> <li>When <i>Done</i> changes to TRUE.</li> <li>When <i>Error</i> changes to TRUE.</li> <li>When <i>CommandAborted</i> changes to TRUE.</li> </ul>
CommandAborted	<ul style="list-style-type: none"> <li>When this instruction is aborted because another motion control instruction was executed with the Buffer Mode set to <b>Aborting</b>.</li> <li>When this instruction is canceled due to an error.</li> <li>When this instruction is executed while there is an error.</li> <li>When you start this instruction during MC_GroupStop instruction execution.</li> </ul>	<ul style="list-style-type: none"> <li>When <i>Execute</i> is TRUE and changes to FALSE.</li> <li>After one period when <i>Execute</i> is FALSE.</li> </ul>
Error	When there is an error in the execution conditions or input parameters for the instruction.	When the error is cleared.

## In-Out Variables

Name	Meaning	Data type	Valid range	Description
AxesGroup	Axes Group	_sGROUP_REF	---	Specify the axes group. *1

- \*1. Specify a user-defined Axes Group Variable that was created in the Axes Group Basic Settings of the Sysmac Studio (default: MC\_Group\*) or a system-defined axes group variable name (\_MC\_GRP[\*], \_MC1\_GRP[\*], or \_MC2\_GRP[\*]). If you use Sysmac Studio version 1.29 or higher, you can specify the system-defined axes group variable name for AT specification of a user-defined variable. This will allow you to specify the user-defined variable. If you use Sysmac Studio version 1.28 or lower, do not specify any user-defined variable created in the variable table.

## Function

- The MC\_MoveLinearAbsolute instruction performs linear interpolation for 2 to 4 axes.
- The target position is specified as an absolute position.

Other specifications are the same as those for the MC\_MoveLinear (Linear Interpolation) instruction. For details, refer to *Function* on page 4-13 for MC\_MoveLinear (Linear Interpolation) instruction.



### Precautions for Correct Use

- An Instruction Execution Error with Undefined Home (error code: 5466 hex) occurs if home is undefined for any of the composition axes in the axes group.
- You cannot execute an instruction to perform linear interpolation if a limit input is ON for any of the logical axes that belong to the axes group.

# MC\_MoveLinearRelative

The MC\_MoveLinearRelative instruction performs linear interpolation for a specified relative position.

Instruction	Name	FB/ FUN	Graphic expression	ST expression
MC_MoveLinear- Relative	Relative Linear Interpolation	FB		<pre>MC_MoveLinearRelative_instance (   AxesGroup :=parameter,   Execute :=parameter,   Distance :=parameter,   Velocity :=parameter,   Acceleration :=parameter,   Deceleration :=parameter,   Jerk :=parameter,   CoordSystem :=parameter,   BufferMode :=parameter,   TransitionMode :=parameter,   Done =&gt;parameter,   Busy =&gt;parameter,   Active =&gt;parameter,   CommandAborted =&gt;parameter,   Error =&gt;parameter,   ErrorID =&gt;parameter );</pre>

## Variables

### Input Variables

Name	Meaning	Data type	Valid range	De- fault	Description
Execute	Execute	BOOL	TRUE or FALSE	FALSE	The instruction is executed when the value of this variable changes to TRUE.
Distance	Travel Distance	ARRAY [0..3] OF LREAL	Negative number, positive number, or 0	0	Specify the target position for linear interpolation. The unit is command units. *1
Velocity*2	Target Velocity	LREAL	Positive number	0	Specify the target velocity. The unit is command units/s. *1
Acceleration	Acceleration Rate	LREAL	Non-negative number	0	Specify the acceleration rate. The unit is command units/s <sup>2</sup> . *1

Name	Meaning	Data type	Valid range	Default	Description
Deceleration	Deceleration Rate	LREAL	Non-negative number	0	Specify the deceleration rate. The unit is command units/s <sup>2</sup> . *1
Jerk	Jerk	LREAL	Non-negative number	0	Specify the jerk. The unit is command units/s <sup>3</sup> . *1
CoordSystem	Coordinate System	_eMC_COORD_SYSTEM	0: _mcACS	0*3	Specify the coordinate system. 0: Axis coordinate system (ACS)
BufferMode	Buffer Mode Selection	_eMC_BUFFER_MODE	0: _mcAborting 1: _mcBuffered 2: _mcBlendingLow 3: _mcBlendingPrevious 4: _mcBlendingNext 5: _mcBlendingHigh	0*3	Specify the behavior when executing more than one motion instruction. 0: Aborting 1: Buffered 2: Blending low 3: Blending previous 4: Blending next 5: Blending high
Transition-Mode	Transition Mode	_eMC_TRANSITION_MODE	0: _mcTMNone 10: _mcTMCornerSuperimposed	0*3	Specify the path of motion. 0: Transition disabled 10: Superimpose corners

- \*1. Refer to *Unit Conversion Settings* in the *NJ/NX-series CPU Unit Motion Control User's Manual (Cat. No. W507)* for information on command units.
- \*2. Always set the target velocity. If the axes are moved without setting a target velocity, an error will occur.
- \*3. The default value for an enumeration variable is actually not the number, but the enumerator.

## Output Variables

Name	Meaning	Data type	Valid range	Description
Done	Done	BOOL	TRUE or FALSE	TRUE when the instruction is completed.
Busy	Executing	BOOL	TRUE or FALSE	TRUE when the instruction is acknowledged.
Active	Controlling	BOOL	TRUE or FALSE	TRUE when the axis is being controlled.
CommandAborted	Command Aborted	BOOL	TRUE or FALSE	TRUE when the instruction is aborted.
Error	Error	BOOL	TRUE or FALSE	TRUE while there is an error.
ErrorID	Error Code	WORD	*1	Contains the error code when an error occurs. A value of 16#0000 indicates normal execution.

- \*1. The upper four digits of the event code give the error code for ErrorID. Refer to the *NJ/NX-series Troubleshooting Manual (Cat. No. W503)* for the event codes.

## ● Output Variable Update Timing

Name	Timing for changing to TRUE	Timing for changing to FALSE
Done	When positioning is completed.	<ul style="list-style-type: none"> <li>When <i>Execute</i> is TRUE and changes to FALSE.</li> <li>After one period when <i>Execute</i> is FALSE.</li> </ul>
Busy	When <i>Execute</i> changes to TRUE.	<ul style="list-style-type: none"> <li>When <i>Done</i> changes to TRUE.</li> <li>When <i>Error</i> changes to TRUE.</li> <li>When <i>CommandAborted</i> changes to TRUE.</li> </ul>
Active	When the axes move.	<ul style="list-style-type: none"> <li>When <i>Done</i> changes to TRUE.</li> <li>When <i>Error</i> changes to TRUE.</li> <li>When <i>CommandAborted</i> changes to TRUE.</li> </ul>
CommandAborted	<ul style="list-style-type: none"> <li>When this instruction is aborted because another motion control instruction was executed with the Buffer Mode set to <b>Aborting</b>.</li> <li>When this instruction is canceled due to an error.</li> <li>When this instruction is executed while there is an error.</li> <li>When you start this instruction during MC_GroupStop instruction execution.</li> </ul>	<ul style="list-style-type: none"> <li>When <i>Execute</i> is TRUE and changes to FALSE.</li> <li>After one period when <i>Execute</i> is FALSE.</li> </ul>
Error	When there is an error in the execution conditions or input parameters for the instruction.	When the error is cleared.

## In-Out Variables

Name	Meaning	Data type	Valid range	Description
AxesGroup	Axes Group	_sGROUP_RE EF	---	Specify the axes group. *1

- \*1. Specify a user-defined Axes Group Variable that was created in the Axes Group Basic Settings of the Sysmac Studio (default: MC\_Group\*) or a system-defined axes group variable name (\_MC\_GRP[\*], \_MC1\_GRP[\*], or \_MC2\_GRP[\*]). If you use Sysmac Studio version 1.29 or higher, you can specify the system-defined axes group variable name for AT specification of a user-defined variable. This will allow you to specify the user-defined variable. If you use Sysmac Studio version 1.28 or lower, do not specify any user-defined variable created in the variable table.

## Function

- The MC\_MoveLinearRelative instruction performs linear interpolation for 2 to 4 axes.
- The target position is specified as a relative position.

Other specifications are the same as those for the MC\_MoveLinear (Linear Interpolation) instruction. For details, refer to *Function* on page 4-13 for MC\_MoveLinear (Linear Interpolation) instruction.



### Precautions for Correct Use

- An Instruction Execution Error with Undefined Home (error code: 5466 hex) occurs if home is undefined for any of the composition axes in the axes group.
- You cannot execute an instruction to perform linear interpolation if a limit input is ON for any of the logical axes that belong to the axes group.

# MC\_MoveCircular2D

The MC\_MoveCircular2D instruction performs circular interpolation for two axes.

Instruction	Name	FB/ FUN	Graphic expression	ST expression
MC_MoveCircular2D	Circular 2D Interpolation	FB		<pre>MC_MoveCircular2D_instance (   AxesGroup :=parameter,   Execute :=parameter,   CircAxes :=parameter,   CircMode :=parameter,   AuxPoint :=parameter,   EndPoint :=parameter,   PathChoice :=parameter,   Velocity :=parameter,   Acceleration :=parameter,   Deceleration :=parameter,   Jerk :=parameter,   CoordSystem :=parameter,   BufferMode :=parameter,   TransitionMode :=parameter,   MoveMode :=parameter,   Done =&gt;parameter,   Busy =&gt;parameter,   Active =&gt;parameter,   CommandAborted =&gt;parameter,   Error =&gt;parameter,   ErrorID =&gt;parameter );</pre>

## Variables

### Input Variables

Name	Meaning	Data type	Valid range	Default	Description
Execute	Execute	BOOL	TRUE or FALSE	FALSE	The instruction is executed when the value of this variable changes to TRUE.
CircAxes	Circular Axes	ARRAY [0,1] OF UINT	0 to 3	0	Specify the axes for circular interpolation. 0: Axis A0 1: Axis A1 2: Axis A2 3: Axis A3
CircMode	Circular Interpolation Mode	_eMC_CIRC_M ODE	0: _mcBorder 1: _mcCenter 2: _mcRadius	0*1	Specify the method for circular interpolation. 0: Border point 1: Center 2: Radius

Name	Meaning	Data type	Valid range	Default	Description
AuxPoint	Auxiliary Point	ARRAY [0,1] OF LREAL	Negative number, positive number, or 0	0	Specify the border point, center, or radius. The unit is command units. *2
EndPoint	End Point	ARRAY [0,1] OF LREAL	Negative number, positive number, or 0	0	Specify the target position. The unit is command units. *2
PathChoice	Path Choice	_eMC_CIRC_PATHCHOICE	0: _mcCW 1: _mcCCW	0*1	Specify the path direction. 0: CW 1: CCW
Velocity*3	Target Velocity	LREAL	Positive number	0	Specify the target velocity. The unit is command units/s. *2
Acceleration	Acceleration Rate	LREAL	Non-negative number	0	Specify the acceleration rate. The unit is command units/s <sup>2</sup> . *2
Deceleration	Deceleration Rate	LREAL	Non-negative number	0	Specify the deceleration rate. The unit is command units/s <sup>2</sup> . *2
Jerk	Jerk	LREAL	Non-negative number	0	Specify the jerk. The unit is command units/s <sup>3</sup> . *2
CoordSystem	Coordinate System	_eMC_COORD_SYSTEM	0: _mcACS	0*1	Specify the coordinate system. 0: Axis coordinate system (ACS)
BufferMode	Buffer Mode Selection	_eMC_BUFFER_MODE	0: _mcAborting 1: _mcBuffered 2: _mcBlendingLow 3: _mcBlendingPrevious 4: _mcBlendingNext 5: _mcBlendingHigh	0*1	Specify the behavior when executing more than one motion instruction. 0: Aborting 1: Buffered 2: Blending low 3: Blending previous 4: Blending next 5: Blending high
Transition-Mode	Transition Mode	_eMC_TRANSITION_MODE	0: _mcTMNone 10: _mcTMCornerSuperimposed	0*1	Specify the path of motion. 0: Transition disabled 10: Superimpose corners
MoveMode	Travel Mode	_eMC_MOVE_MODE	0: _mcAbsolute 1: _mcRelative	0*1	Select the travel method. 0: Absolute positioning 1: Relative positioning

\*1. The default value for an enumeration variable is actually not the number, but the enumerator.

\*2. Refer to *Unit Conversion Settings* in the *NJ/NX-series CPU Unit Motion Control User's Manual (Cat. No. W507)* for information on command units.

\*3. Always set the target velocity. If the axes are moved without setting a target velocity, an error will occur.

## Output Variables

Name	Meaning	Data type	Valid range	Description
Done	Done	BOOL	TRUE or FALSE	TRUE when the instruction is completed.
Busy	Executing	BOOL	TRUE or FALSE	TRUE when the instruction is acknowledged.
Active	Controlling	BOOL	TRUE or FALSE	TRUE when the axis is being controlled.
CommandAborted	Command Aborted	BOOL	TRUE or FALSE	TRUE when the instruction is aborted.
Error	Error	BOOL	TRUE or FALSE	TRUE while there is an error.
ErrorID	Error Code	WORD	*1	Contains the error code when an error occurs. A value of 16#0000 indicates normal execution.

\*1. The upper four digits of the event code give the error code for ErrorID. Refer to the *NJ/NX-series Troubleshooting Manual (Cat. No. W503)* for the event codes.

### ● Output Variable Update Timing

Name	Timing for changing to TRUE	Timing for changing to FALSE
Done	When positioning is completed.	<ul style="list-style-type: none"> <li>When <i>Execute</i> is TRUE and changes to FALSE.</li> <li>After one period when <i>Execute</i> is FALSE.</li> </ul>
Busy	When <i>Execute</i> changes to TRUE.	<ul style="list-style-type: none"> <li>When <i>Done</i> changes to TRUE.</li> <li>When <i>Error</i> changes to TRUE.</li> <li>When <i>CommandAborted</i> changes to TRUE.</li> </ul>
Active	When the axes move.	<ul style="list-style-type: none"> <li>When <i>Done</i> changes to TRUE.</li> <li>When <i>Error</i> changes to TRUE.</li> <li>When <i>CommandAborted</i> changes to TRUE.</li> </ul>
CommandAborted	<ul style="list-style-type: none"> <li>When this instruction is aborted because another motion control instruction was executed with the Buffer Mode set to <b>Aborting</b>.</li> <li>When this instruction is canceled due to an error.</li> <li>When this instruction is executed while there is an error.</li> <li>When you start this instruction during MC_GroupStop instruction execution.</li> </ul>	<ul style="list-style-type: none"> <li>When <i>Execute</i> is TRUE and changes to FALSE.</li> <li>After one period when <i>Execute</i> is FALSE.</li> </ul>
Error	When there is an error in the execution conditions or input parameters for the instruction.	When the error is cleared.

## In-Out Variables

Name	Meaning	Data type	Valid range	Description
AxesGroup	Axes Group	_sGROUP_REF	---	Specify the axes group. *1

\*1. Specify a user-defined Axes Group Variable that was created in the Axes Group Basic Settings of the Sysmac Studio (default: MC\_Group\*) or a system-defined axes group variable name (\_MC\_GRP[\*], \_MC1\_GRP[\*], or \_MC2\_GRP[\*]).



If you use Sysmac Studio version 1.29 or higher, you can specify the system-defined axes group variable name for AT specification of a user-defined variable. This will allow you to specify the user-defined variable.

If you use Sysmac Studio version 1.28 or lower, do not specify any user-defined variable created in the variable table.

## Function

- The MC\_MoveCircular2D instruction performs 2D circular interpolation for two axes.



### Precautions for Correct Use

- An Instruction Execution Error with Undefined Home (error code: 5466 hex) occurs if home is undefined for any of the composition axes in the axes group.
- You cannot execute an instruction to perform circular 2D interpolation if a limit input is ON for any of the logical axes that belong to the axes group.

## Instruction Details

This section describes the instruction in detail.

### ● Circular Interpolation Procedure

Use the following procedure to perform circular interpolation.

#### 1 Registering Axes Groups for Interpolation

- Determine the axes group to perform interpolation.  
An axes group is represented by `_MC_GRP[*]`, `_MC1_GRP[*]`, or `_MC2_GRP[*]`.
- Specify the axis composition with **Composition** of the Axes Group Variable.
- Specify the combination of axes to perform interpolation with **Axis Selection** of the Axes Group Variable.
- Use logical axes (axis A0 to A3) for the axes, and not axis numbers.
- Specify axis numbers for the logical axes A0 to A3 in order from the lowest number with **Axis Selection**.
- The axis number is specified as follows according to the model or series.

Model or series	Axis number
NX701 CPU Unit	Axis 0 to Axis 255
NX502 CPU Unit	Axis 0 to Axis 255
NX102 CPU Unit	Axis 0 to Axis 14
NX1P2 CPU Unit	Axis 0 to Axis 11
NJ-series CPU Unit	Axis 0 to Axis 63

**Example:** The following specifications are used to specify axis numbers 0 and 1 for axes A0 and A1 with a 2-axis composition.

Logical axis	Axis number	Description
Axis A0	Axis 0	Specify axis numbers to the logical axes from axis A0 in order from the lowest number.
Axis A1	Axis 1	

**Precautions for Correct Use**

An Instruction Not Allowed for Encoder Axis Type error (543D hex) will occur and operation will end if an encoder axis or virtual encoder axis is included in the axes group. Make sure that you select only **Servo Axis** or **Virtual Servo Axis**.

**Additional Information**

For the details of the axis numbers, refer to the *NJ/NX-series CPU Unit Motion Control User's Manual (Cat. No. W507)*.

**2** Enabling the Axes Group

- Turn ON the Servo for the composition axes of the axes group, and then define home for each of the composition axes.
- Execute the MC\_GroupEnable (Enable Axes Group) instruction to enable the registered axes group.

Using the Circular Interpolation instruction is now enabled.

**● CircAxes (Circular Axes)**

Circular interpolation uses the X axis and Y axis.

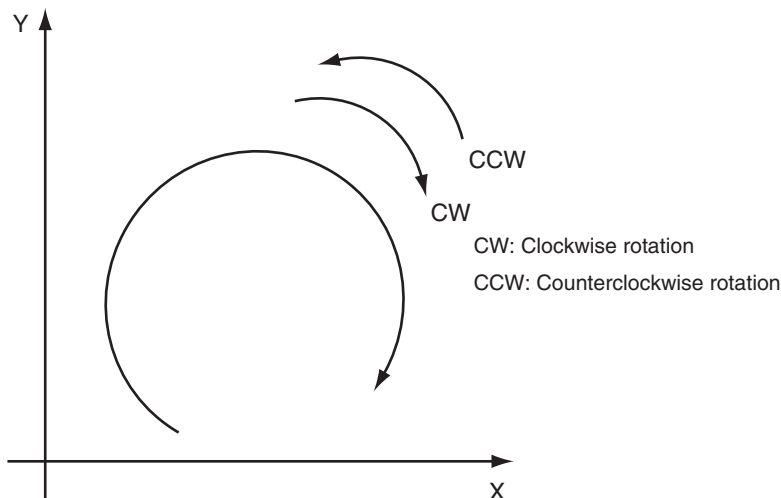

Specify the axes to use as the X axis and Y axis with *CircAxes* (Circular Axes). Use logical axes (axis A0 to A3) for the axes, and not axis numbers.

**Precautions for Correct Use**

Specify the Count Mode to **Linear Mode** for the axes that you use for the X axis and Y axis. If you specify **Rotary Mode**, an Instruction Execution Error Caused by Count Mode Setting (error code: 544A hex) will occur at execution.

**● CircMode (Circular Interpolation Mode)**

There are three methods of circular interpolation: border point, center, and radius. You can specify one of these methods with *CircMode* (Circular Interpolation Mode).

You can specify **Absolute positioning** or **Relative positioning** with *MoveMode* (Travel Mode) to specify the position in these methods.

MoveMode	Description
Absolute positioning	The border point and end point for a border point specification or the center point and end point for a center point specification are specified as absolute positions from home in the axis coordinate system.
Relative positioning	The border point and end point for a border point specification or the center point and end point for a center point specification are specified as relative positions from the start point.

The difference between **Absolute positioning** and **Relative positioning** using a border point is described below as an example.

Circular Interpolation Method: Border Point Specification with Absolute Positioning

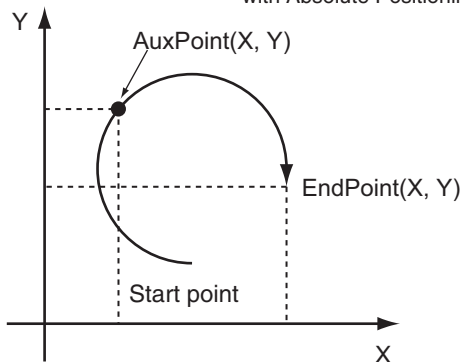

Circular Interpolation Method: Border Point Specification with Relative Positioning

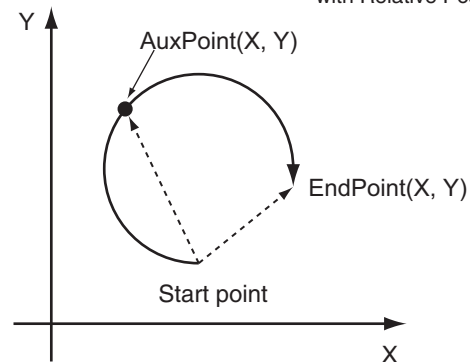

The following sections describe the operation assuming that **Absolute positioning** has been specified as the *MoveMode* (Travel Mode).

### Border point

The current position is the starting point. Circular interpolation is performed through the border point  $AuxPoint(X, Y)$  to the end point  $EndPoint(X, Y)$ .

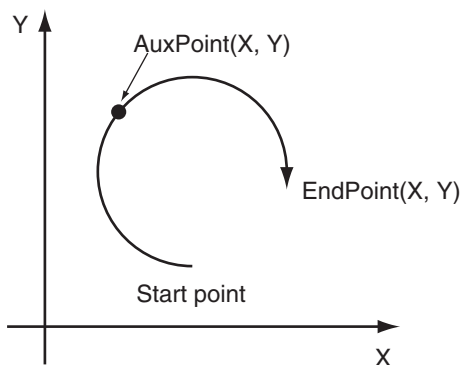

If the start point, border point, and end point are along the same line, if the border point and the end point are at the same point, or if the start point and the border point are the same point, linear interpolation is performed from the start point to the end point.

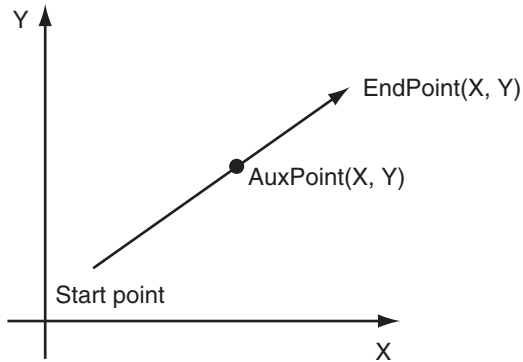

### Precautions for Correct Use

- The points are considered to be on a straight line if the distance between the border point and the line that connects the start and end point is less than one pulse for both the X and Y coordinates.
- An error occurs if the start point, border point, and end point are the same point. The start point, border point, and end point are considered to be the same point if the command positions are the same for the command unit. If the command positions in the command unit are different, the points are not considered to be the same point and an error does not occur even if the positions are the same when they are converted to pulses.

If the start point and the end point are the same point, a complete circle is drawn with the start point and the border point as the diameter. *PathChoice* is specified as the circular interpolation direction.

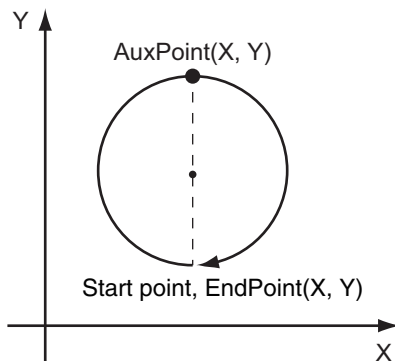

### Center

The current position is the starting point. Circular interpolation is performed for circle specified by the center point AuxPoint(X,Y) to the end point EndPoint(X,Y).

*PathChoice* is used to specify the circular interpolation direction.

A complete circle is drawn when the start point and end point are at the same point.

If the radius from the specified center to the start point is different to the radius to the end point, the average of the two radiuses is used to perform circular interpolation. In this case, the center is calculated in the same way as specifying the radius, and the calculated radius and center are used.

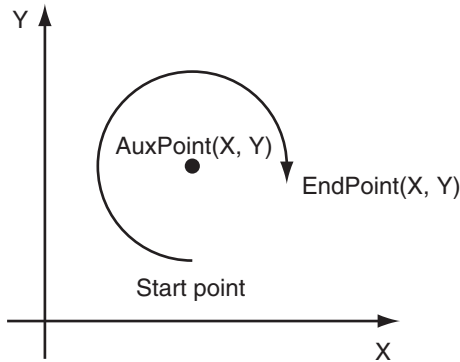

### Precautions for Correct Use

If the **Correction Allowance Ratio** axes group parameter is set to any value other than 0 and the specified center point exceeds the circle that is calculated with the following formula, a Circular Interpolation Center Specification Position Out of Range error (error code: 5449 hex) will occur.

- The radius of the circle in which the center point must be positioned is the calculated radius multiplied by the percentage that is set for the center point specification check method divided by 100. (The radius calculated from the corrected center point is taken as 100%.)

### Radius

The current position is the starting point. Circular interpolation is performed for the circle specified by the radius AuxPoint(X,Y) to the end point EndPoint(X,Y).

The radius is specified by the first element in AuxPoint(X,Y). The second element is not used.

For example, for a radius of 100, set AuxPoint(X,Y) to AuxPoint(100,0).

If the sign of the radius is negative, a circle with a long arc will be drawn. If the sign is positive, a circle with a short arc will be drawn.

*PathChoice* is used to specify the circular interpolation direction.

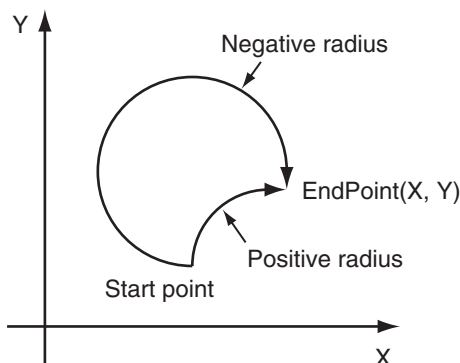

### Precautions for Correct Use

- If the start point and the end point are the same, a same circular interpolation start and end point error will occur and operation will stop for all axes in the group.
- If the specified radius is less than half the length of the distance between the start point and end point, a circle is impossible and an error will occur.

## ● Velocity (Target Velocity), Acceleration (Acceleration Rate), Deceleration (Deceleration Rate), and Jerk

- Set *Velocity*, *Acceleration*, *Deceleration*, and *Jerk* to specify the interpolation velocity, acceleration rate, deceleration rate, and jerk for circular interpolation.
- If you set the interpolation velocity for circular interpolation to 0, a velocity specification error will occur and operation will stop for all axes in the group.
- If the specified interpolation velocity exceeds the maximum velocity of an axis, the following operation is executed.

If only one axis exceeds the maximum velocity	: This axis moves at the maximum velocity and the interpolation velocity is adjusted accordingly.
If both axes exceed the maximum velocity	: The interpolation velocity is automatically adjusted so that the axes move at the maximum velocity of the two axes that is slower.

### Jerk

The relationships between *Acceleration* (Acceleration Rate), *Deceleration* (Deceleration Rate), and *Velocity* (Target Velocity) when *Jerk* is set to 0 and when it is set to any other value are shown below.

- *Jerk* Set to 0

The command value for the velocity is created with acceleration rate  $A_t$  and deceleration rate  $D_t$ .

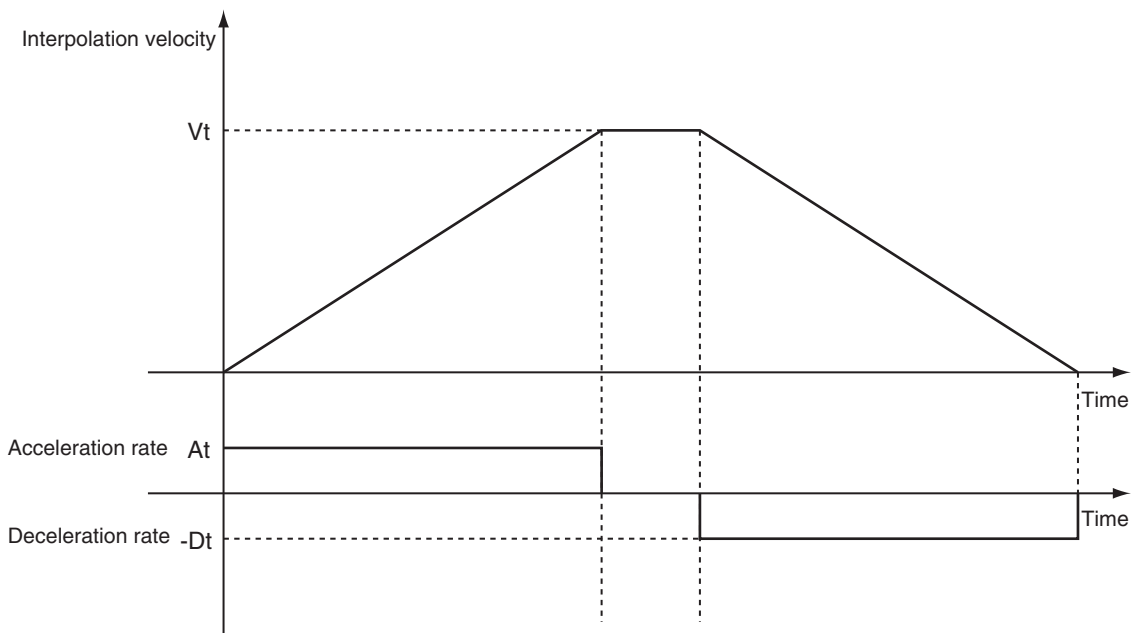

$V_t$ : Specified interpolation velocity,  $A_t$ : Specified acceleration rate,  $D_t$ : Specified deceleration rate.

- Short Travel Distance When *Jerk* Is 0

The interpolation velocity will not reach the specified  $V_t$  (Target Velocity).

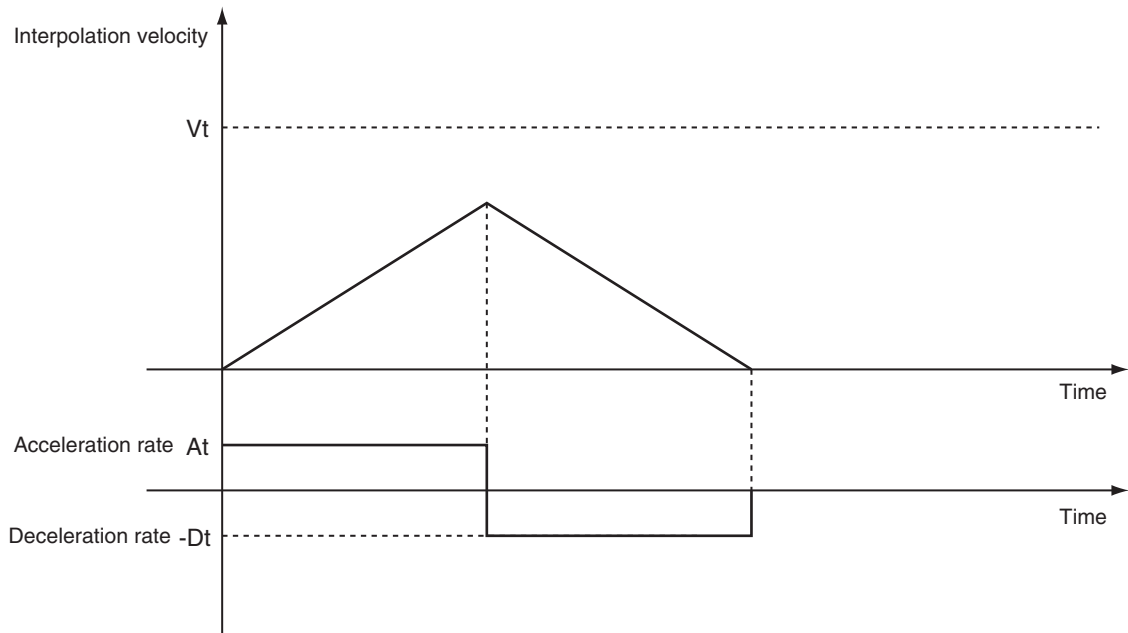

$V_t$ : Specified interpolation velocity,  $A_t$ : Specified acceleration rate,  $D_t$ : Specified deceleration rate.

- *Jerk* Set to Value Other Than 0

The command value for the velocity is created with  $A_t$  as the upper acceleration limit and  $D_t$  as the upper deceleration limit.

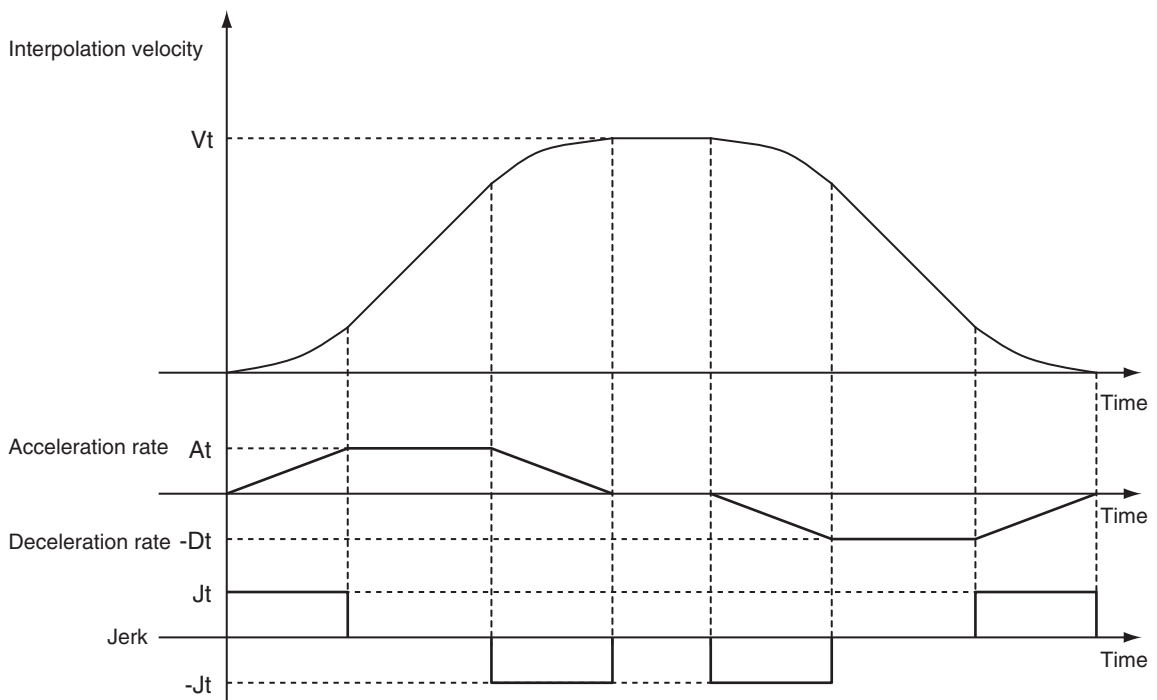

$V_t$ : Specified interpolation velocity,  $A_t$ : Specified acceleration rate,  $D_t$ : Specified deceleration rate,  $J_t$ : Specified jerk

- Short Travel Distance When *Jerk* Is Other Than 0

The interpolation velocity will not reach the specified  $V_t$  (Target Velocity).

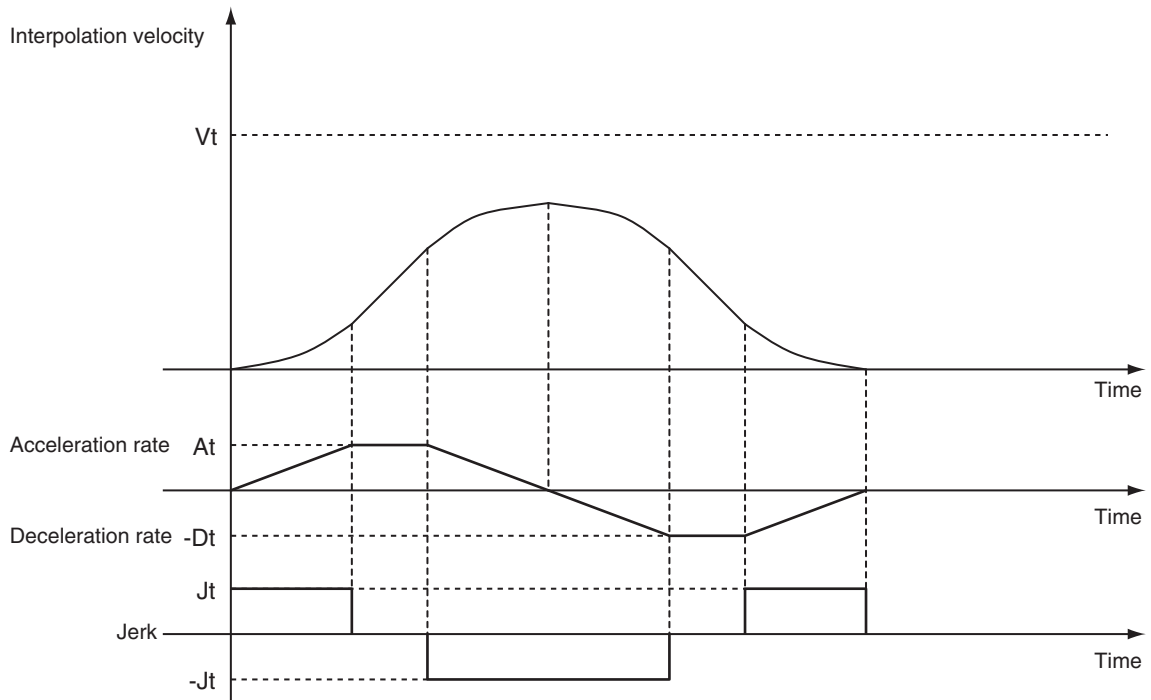

Vt: Specified interpolation velocity, At: Specified acceleration rate, Dt: Specified deceleration rate, Jt: Specified jerk



**Additional Information**

- If 0 is specified for *Acceleration* (Acceleration Rate), the specified interpolation velocity is used immediately.
- If 0 is specified for *Deceleration* (Deceleration Rate), the axis stops immediately. However, if the *Buffer Mode* is set to **Blending**, axis operation will change to the interpolation velocity specified by the next operation without stopping. For details, refer to *Buffer Mode (Buffer Mode Selection)* on page 4-19.
- When the *Acceleration* (Acceleration Rate) or *Deceleration* (Deceleration Rate) is 0, the setting of *Jerk* is disabled.

● **CoordSystem (Coordinate System)**

- CoordSystem specifies the coordinate system to use for circular interpolation.
- Only an axis coordinate system (ACS) consisting of two or more axes is supported.

● **BufferMode (Buffer Mode Selection)**

- This variable specifies how to join the axis motions for this interpolation instruction and the previous interpolation instruction.
- There are the following six settings.

Buffer Mode Selection	Description
Aborting	Aborts the instruction being executed and switches to this instruction. If the direction of axis motion is reversed by switching instructions, the motion will be reversed according to the <b>Operation Selection at Reversing</b> axis parameter.
Buffered	Buffers this instruction and executes it automatically after the current instruction is completed.



Buffer Mode Selection	Description
Blending	Starts the buffered instruction at the velocity (transit velocity) at which the current instruction reaches the target position. The operation of the current instruction is changed so that the axes reach the target position at the transit velocity. There are four methods to specify the transit velocity. These are described below. You can also specify a Transition Mode as an option to the Blending Mode (see below).
Blending low	The lower of the target velocities of the current instruction and the buffered instruction is used as the transit velocity.
Blending previous	The target velocity of the current instruction is used as the transit velocity.
Blending next	The target velocity of the buffered instruction is used as the transit velocity.
Blending high	The higher of the target velocities of the current instruction and the buffered instruction is used as the transit velocity.

For details on *BufferMode* (Buffer Mode Selection), refer to the *NJ/NX-series CPU Unit Motion Control User's Manual (Cat. No. W507)*.

## ● TransitionMode

- This variable specifies how to combine the paths created by the previous interpolation operation and the next interpolation operation.
- Set the *TransitionMode* to either `_mcTMNone` (Transition Disabled) or `_mcTMCornerSuperimposed` (Superimpose Corners).
- *TransitionMode* is enabled when **Blending** is specified for *BufferMode*.
- An error will occur if you do not set *TransitionMode* to `_mcTMNone` (Transition Disabled) when **Blending** is not used.

### Transition Disabled

The path is given priority when creating the velocity command value, so velocity command values of the axes may change rapidly when switching from one operation to the next.

### Operation Example

The *Velocity* (Target Velocity), *BufferMode*, and *TransitionMode* when transitioning from P1 to P2, and from P2 to P3 are shown below.

- Motion from P1 to P2: Velocity = F, BufferMode = Aborting, TransitionMode = `_mcTMNone` (Transition Disabled)
- Motion from P2 to P3: Velocity = F, BufferMode = Blending with next, TransitionMode = `_mcTMNone` (Transition Disabled)
- The motion starts from position P1 and goes through position P2. Linear interpolation is performed to position P3.
- The linear interpolation velocity F is maintained when passing position P2. Because of this, the velocity is discontinuous at position P2 as shown in the following figure.

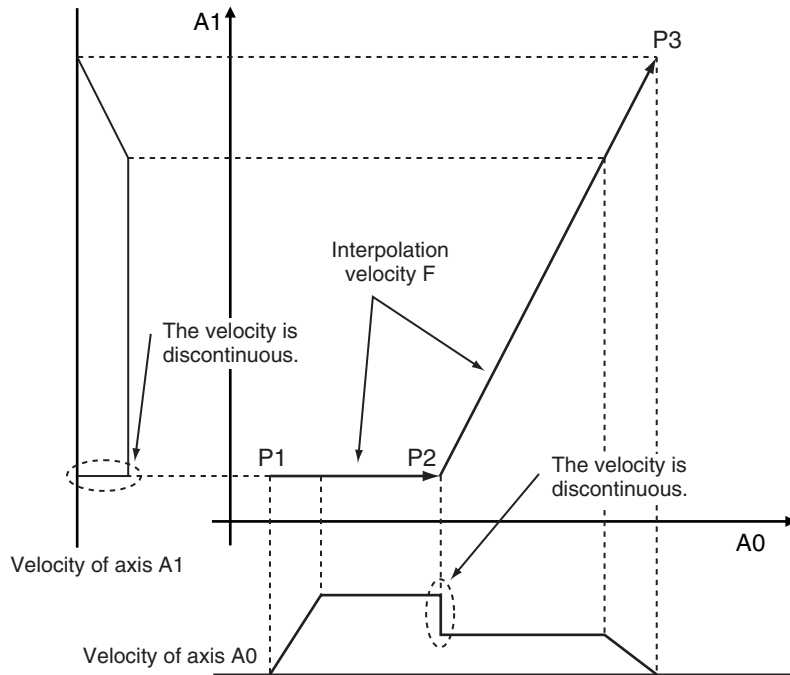

### Superimpose Corners

Use the superimpose corners specification when you want make the axes command velocities continuous.

#### Operation Example

*Velocity* (Target Velocity), *BufferMode*, and *TransitionMode* when transitioning from P1 to P2, and from P2 to P3 are shown below.

- Motion from P1 to P2: Velocity = F, BufferMode = Aborting, TransitionMode = `_mcTMNone` (Transition Disabled)
- Motion from P2 to P3: Velocity = F, BufferMode = Blending with next, TransitionMode = `_mcTMCornerSuperimposed` (Superimpose Corners)
- The motion starts from position P1 and passes near position P2. Linear interpolation is performed to position P3.
- To make the axes command velocities continuous, the deceleration range of the previous motion and the acceleration range of the current motion are combined to create the command velocity. For this reason, the acceleration time of the current motion is the same as the deceleration time of the previous motion.

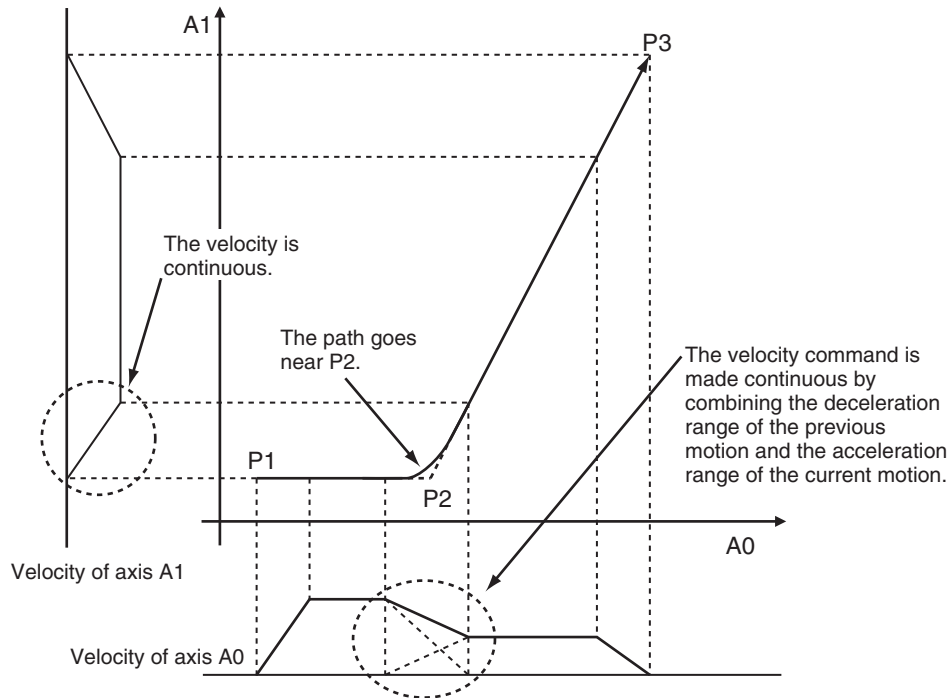

The combined path passes near P2.

The distance from P2 to the path is as below:

- It is longer when the interpolation velocity is faster or the deceleration rate of the previous instruction is smaller.
- It is shorter when the interpolation velocity is slower or the deceleration rate of the previous instruction is larger.



#### Additional Information

The *Jerk* settings are disabled in the region with superimposed corners.

## Re-execution of Motion Control Instructions

This instruction cannot be re-executed.

A Motion Control Instruction Re-execution Disabled error (error code: 543B hex) occurs if re-execution is attempted, and all axes in the circular interpolation motion stop.

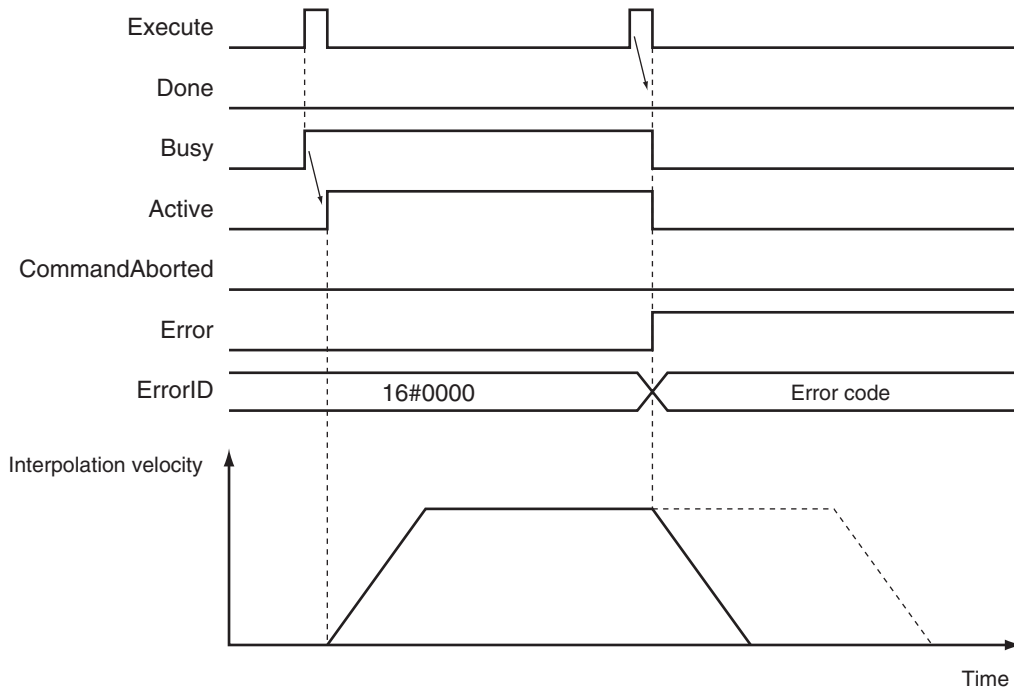

## Multi-execution of Motion Control Instructions

A restriction applies to the instructions that can be used while this instruction is in execution.

For details on multi-execution of motion control instructions, refer to the *NJ/NX-series CPU Unit Motion Control User's Manual (Cat. No. W507)*.

## Errors

If an error occurs during instruction execution, *Error* will change to TRUE.

You can find out the cause of the error by referring to the value output by *ErrorID* (Error Code).

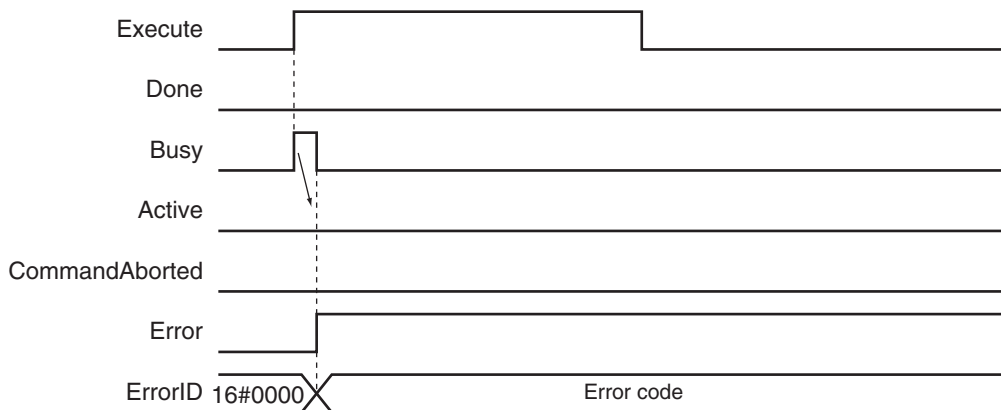

### ● Error Codes

Refer to the *NJ/NX-series Troubleshooting Manual (Cat. No. W503)* for instruction errors.

## Sample Programming

This section shows sample programming for circular interpolation with multi-execution of instructions.

### Parameter Settings

The minimum settings required for this sample programming are given below.

#### ● Setting Axis Parameters

##### Axis Types

Axis	Axis Type
Axis 1	Servo axis
Axis 2	Servo axis

##### Count Modes

Axis	Count mode
Axis 1	Linear Mode
Axis 2	Linear Mode

##### Units of Display

Axis	Unit of Display
Axis 1	mm
Axis 2	mm

#### ● Axes Group Parameter Settings

##### Axis Composition

Two axes are set.

##### Axis Selection

Axis 1 and axis 2 are set.

### Operation Example

The following is an example of operation where the axes automatically perform positioning by using linear interpolation and circular interpolation.

The axes move to the final target position(20.00 mm, 20.00 mm) using linear interpolation and circular interpolation.

The *Buffer Mode* is set to **Buffered** and multi-execution of instructions is used.

In this sample, multi-execution of instructions is performed for (2) to (4) if the *Active* output variable from linear interpolation (1) is TRUE. For multi-axes coordinated operation, multi-execution is possible for up to seven instructions.

## ● Operation Pattern

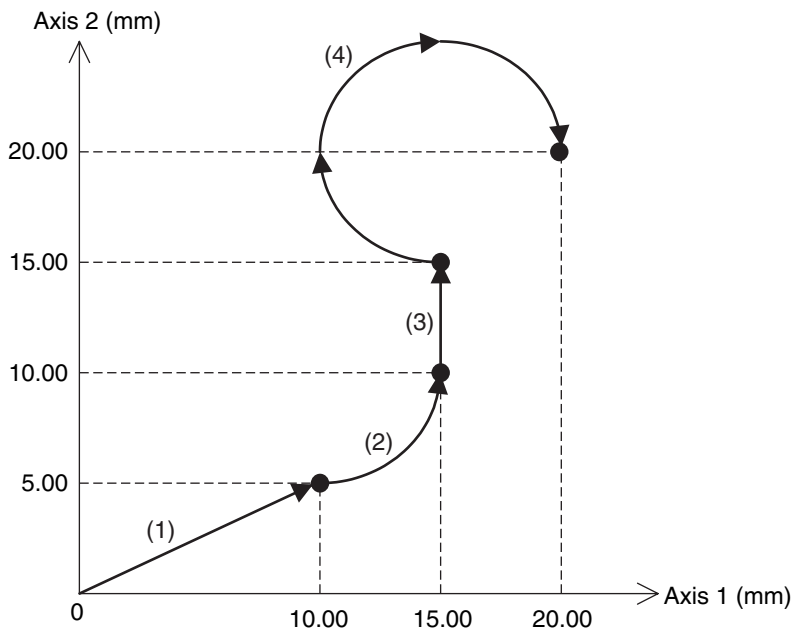

### 1 Execution

When you turn ON the operation start switch at home, the axes move to the point (10.00 mm, 5.00 mm) via linear interpolation.

### 2 Continuous Motion

The axes continue to move to the point (15.00 mm, 10.00 mm) via circular interpolation, to the point (15.00 mm, 15.00 mm) via linear interpolation, and to the point (20.00 mm, 20.00 mm) via circular interpolation.

Here, the velocity is 10.00 mm/s.

## Ladder Diagram

### ● Main Variables

Name	Data type	Default	Comment
MC_Group000	_sGROUP_REF	---	This is the Axes Group Variable for axes group 0.
MC_Group000.MFaultLvl.Active	BOOL	FALSE	TRUE while there is a minor fault level error for axes group 0.
MC_Group000.Status.Disabled	BOOL	FALSE	The value is TRUE when axes group 0 is disabled.
MC_Axis000	_sAXIS_REF	---	This is the Axis Variable for axis 1.
MC_Axis000.Details.Homed	BOOL	FALSE	TRUE when home is defined for axis 1.
MC_Axis000.MFaultLvl.Active	BOOL	FALSE	TRUE while there is a minor fault level error for axis 1.
MC_Axis001	_sAXIS_REF	---	This is the Axis Variable for axis 2.
MC_Axis001.Details.Homed	BOOL	FALSE	TRUE when home is defined for axis 2.

Name	Data type	Default	Comment
MC_Axis001.MFaultLvl.Active	BOOL	FALSE	TRUE while there is a minor fault level error for axis 2.
Pwr1_Status	BOOL	FALSE	This variable is assigned to the <i>Status</i> output variable from the PWR1 instance of the MC_Power instruction. This variable changes to TRUE when the Servo is turned ON.
Pwr2_Status	BOOL	FALSE	This variable is assigned to the <i>Status</i> output variable from the PWR2 instance of the MC_Power instruction. This variable changes to TRUE when the Servo is turned ON.
StartPg	BOOL	FALSE	The Servos for the axes in the axes group are turned ON if this variable is TRUE and Ether-CAT process data communications are established.
InitFlag	BOOL	FALSE	This variable indicates if it is necessary to set the input parameters. Input parameters are set when this variable is FALSE. When setting the input parameters is completed, this variable changes to TRUE.

● Sample Programming

If *StartPg* is TRUE, check that the Servo Drives for each axis are ready.

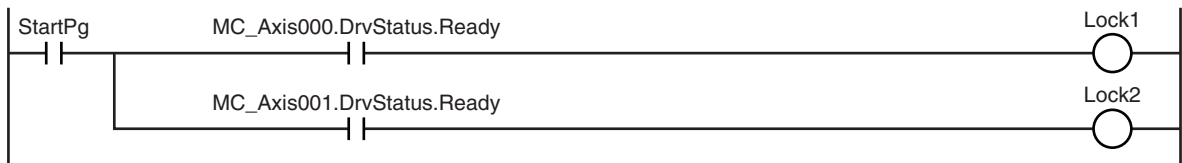

If the Servo Drive is ready, the Servo is turned ON.

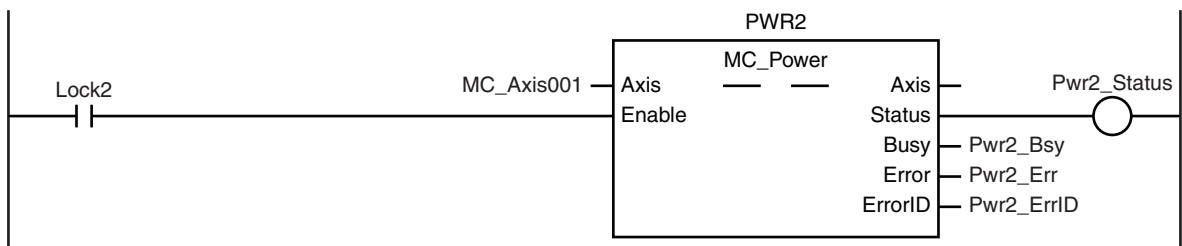
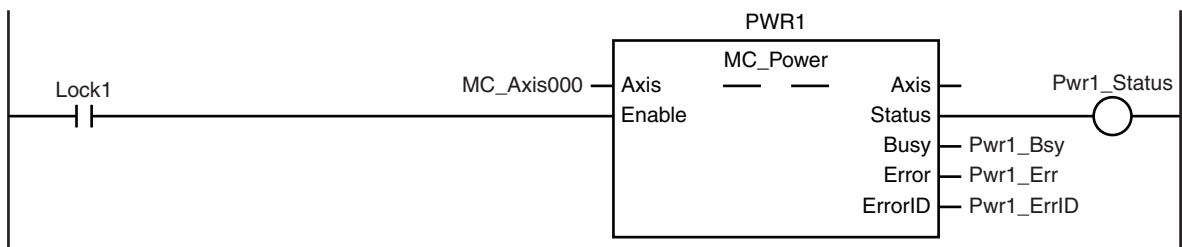

If a minor fault level error occurs for the axis composition, the error handler for the device (FaultHandler) is executed.  
Program the FaultHandler according to the device.

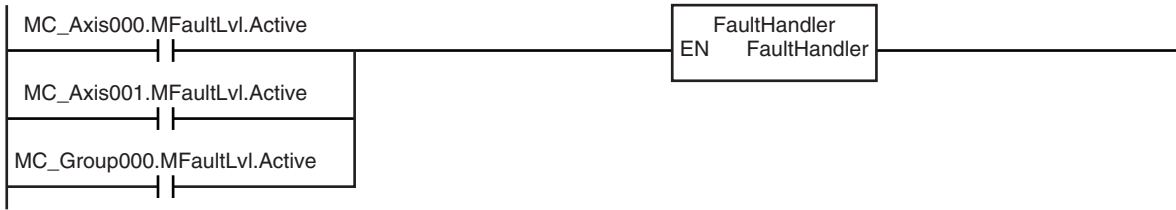

If the Servo is ON for axis 1 and home is not defined, the Home instruction is executed.

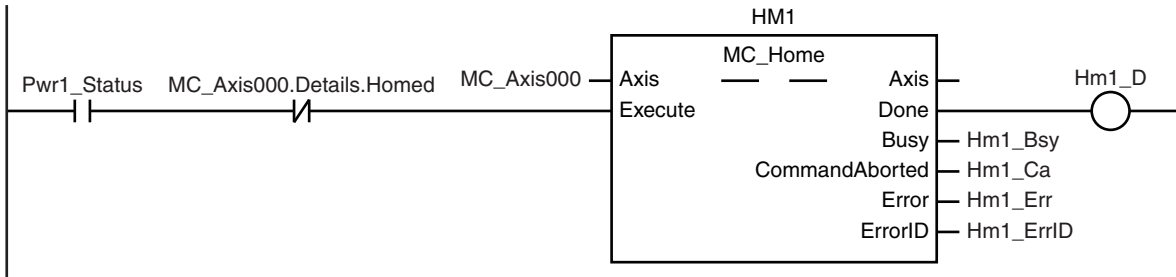

If the Servo is ON for axis 2 and home is not defined, the Home instruction is executed.

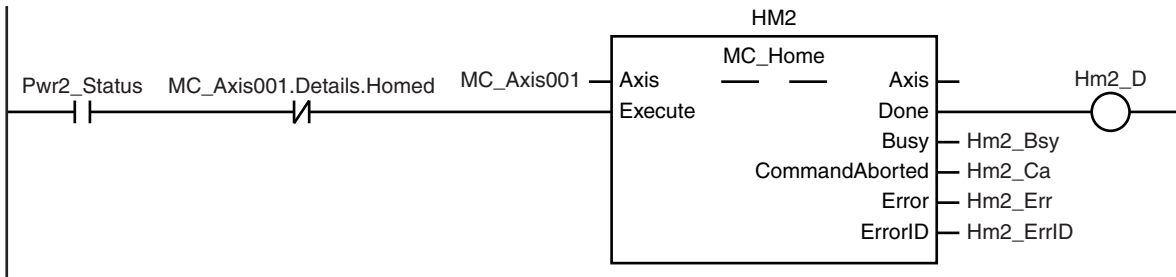

After home is defined for axis 1 and axis 2, the axes group is enabled.

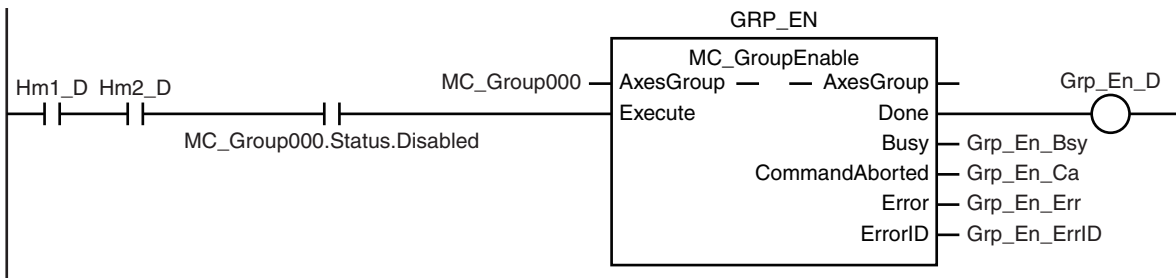

The parameters are set for linear interpolation and circular interpolation.

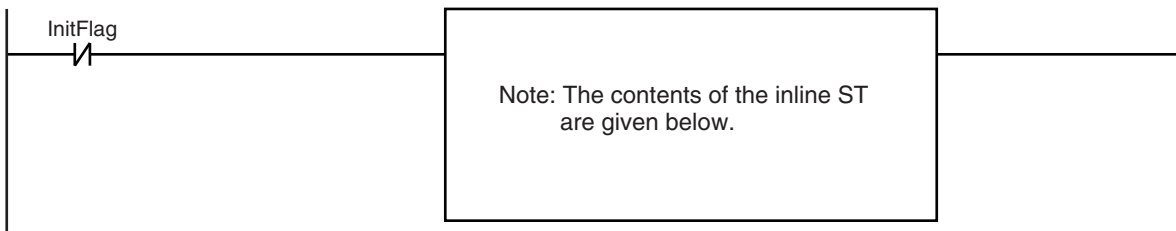



If the axes group is enabled, linear interpolation (1) is executed.

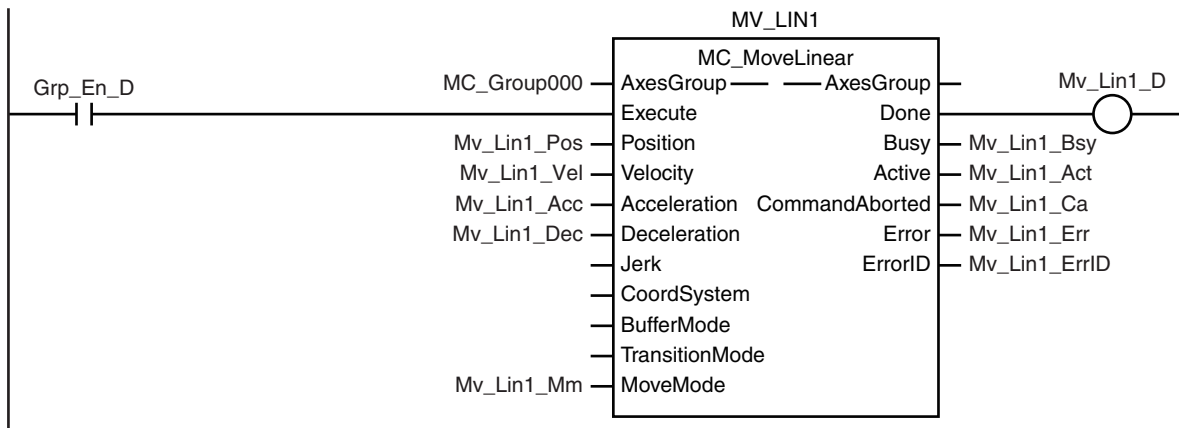

Circular interpolation (2) is executed with multi-execution of instructions after linear interpolation (1) is started.

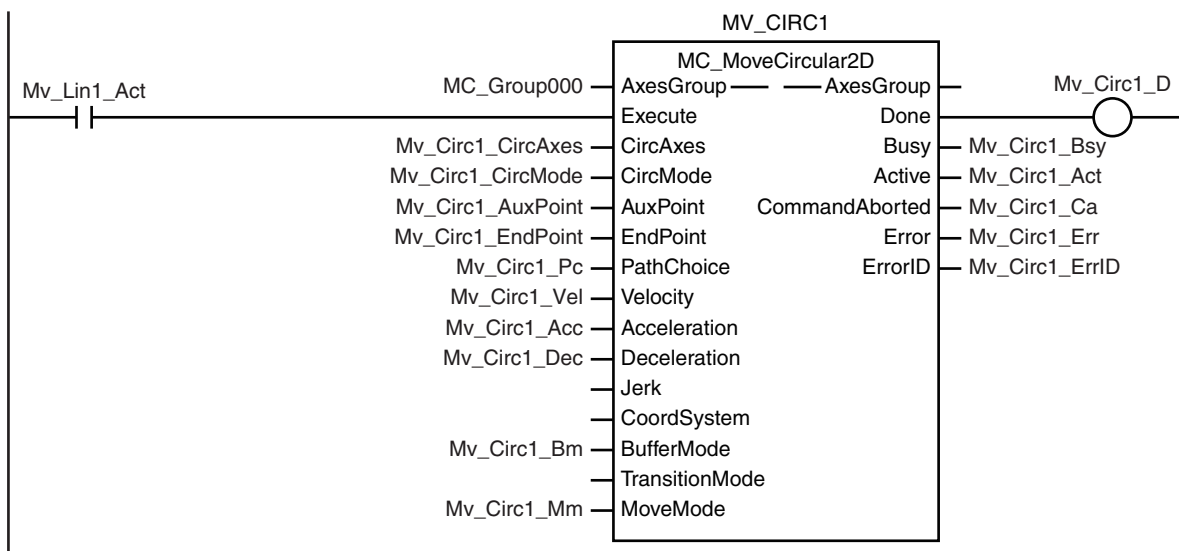

Linear interpolation (3) is executed with multi-execution of instructions after linear interpolation (1) is started.

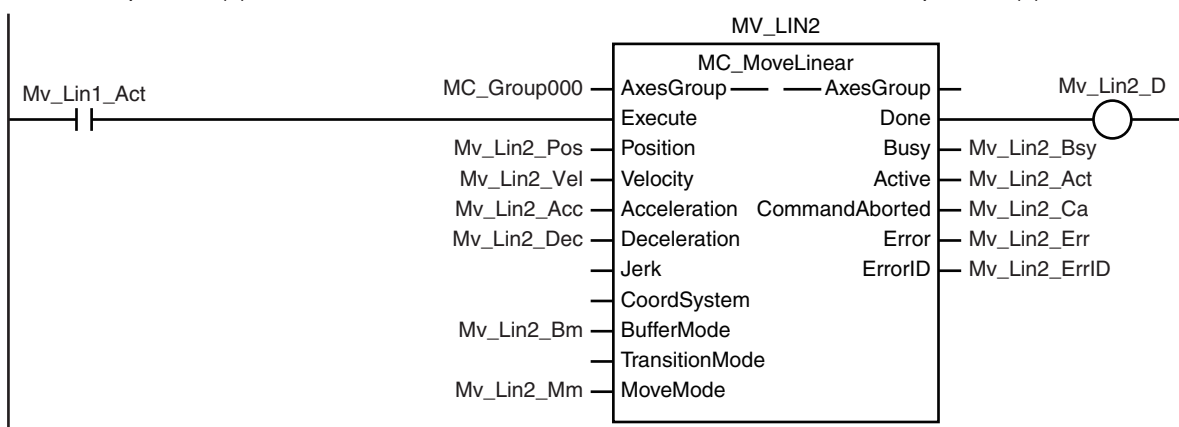

Circular interpolation (4) is executed with multi-execution of instructions after linear interpolation (1) is started.

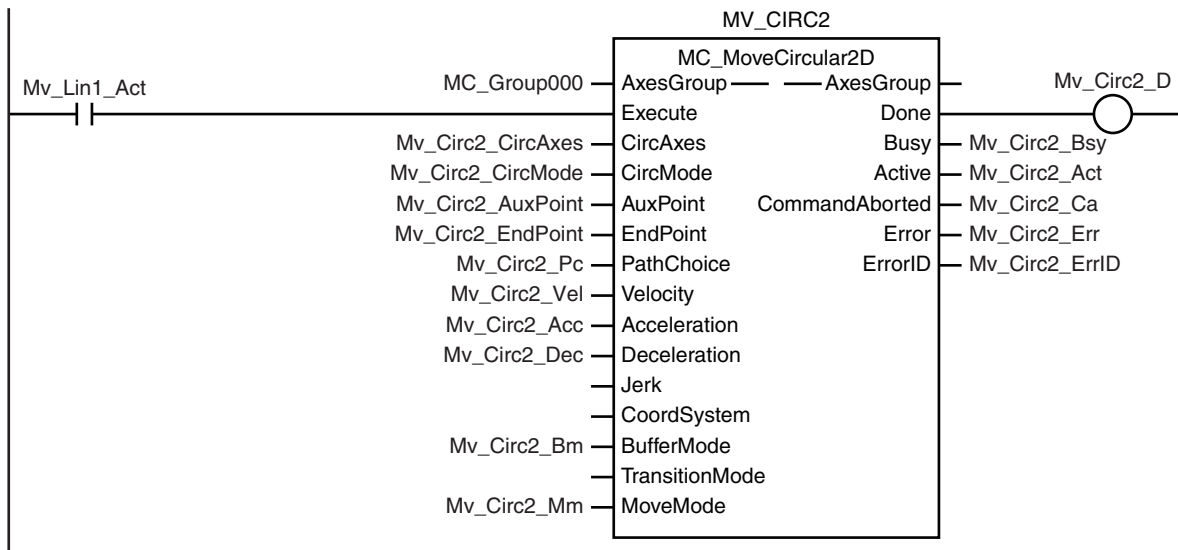

### Contents of Inline ST

```
// MV_CIRC1 parameters
Mv_Circ1_CircAxes[0] := UINT#0;
Mv_Circ1_CircAxes[1] := UINT#1;
Mv_Circ1_CircMode := _eMC_CIRC_MODE#_mcRadius;
Mv_Circ1_AuxPoint[0] := LREAL#5.0;
Mv_Circ1_AuxPoint[1] := LREAL#0.0;
Mv_Circ1_EndPoint[0] := LREAL#15.0;
Mv_Circ1_EndPoint[1] := LREAL#10.0;
Mv_Circ1_Pc := _eMC_CIRC_PATHCHOICE#_mcCCW;
Mv_Circ1_Vel := LREAL#100.0;
Mv_Circ1_Acc := LREAL#20.0;
Mv_Circ1_Dec := LREAL#20.0;
Mv_Circ1_Bm := _eMC_BUFFER_MODE#_mcBuffered;
Mv_Circ1_Mm := _eMC_MOVE_MODE#_mcAbsolute;

// MV_CIRC2 parameters
Mv_Circ2_CircAxes[0] := UINT#0;
Mv_Circ2_CircAxes[1] := UINT#1;
Mv_Circ2_CircMode := _eMC_CIRC_MODE#_mcCenter;
Mv_Circ2_AuxPoint[0] := LREAL#15.0;
Mv_Circ2_AuxPoint[1] := LREAL#20.0;
Mv_Circ2_EndPoint[0] := LREAL#20.0;
Mv_Circ2_EndPoint[1] := LREAL#20.0;
Mv_Circ2_Pc := _eMC_CIRC_PATHCHOICE#_mcCW;
Mv_Circ2_Vel := LREAL#100.0;
Mv_Circ2_Acc := LREAL#20.0;
Mv_Circ2_Dec := LREAL#20.0;
Mv_Circ2_Bm := _eMC_BUFFER_MODE#_mcBuffered;
Mv_Circ2_Mm := _eMC_MOVE_MODE#_mcAbsolute;
```

```

// MV_LIN1 parameters
Mv_Lin1_Pos[0] := LREAL#10.0;
Mv_Lin1_Pos[1] := LREAL#5.0;
Mv_Lin1_Vel := LREAL#100.0;
Mv_Lin1_Acc := LREAL#20.0;
Mv_Lin1_Dec := LREAL#20.0;
Mv_Lin1_Mm := _eMC_MOVE_MODE#_mcAbsolute;

// MV_LIN2 parameters
Mv_Lin2_Pos[0] := LREAL#15.0;
Mv_Lin2_Pos[1] := LREAL#15.0;
Mv_Lin2_Vel := LREAL#100.0;
Mv_Lin2_Acc := LREAL#20.0;
Mv_Lin2_Dec := LREAL#20.0;
Mv_Lin2_Bm := _eMC_BUFFER_MODE#_mcBuffered;
Mv_Lin2_Mm := _eMC_MOVE_MODE#_mcAbsolute;

// Change InitFlag to TRUE after setting the input parameters.
InitFlag := TRUE;

```

## Structured Text (ST)

### ● Main Variables

Name	Data type	Default	Comment
MC_Group000	_sGROUP_REF	---	This is the Axes Group Variable for axes group 0.
MC_Group000.MFaultLvl.Active	BOOL	FALSE	TRUE while there is a minor fault level error for axes group 0.
MC_Group000.Status.Disabled	BOOL	FALSE	The value is TRUE when axes group 0 is disabled.
MC_Axis000	_sAXIS_REF	---	This is the Axis Variable for axis 1.
MC_Axis000.Details.Homed	BOOL	FALSE	TRUE when home is defined for axis 1.
MC_Axis000.MFaultLvl.Active	BOOL	FALSE	TRUE while there is a minor fault level error for axis 1.
MC_Axis001	_sAXIS_REF	---	This is the Axis Variable for axis 2.
MC_Axis001.Details.Homed	BOOL	FALSE	TRUE when home is defined for axis 2.
MC_Axis001.MFaultLvl.Active	BOOL	FALSE	TRUE while there is a minor fault level error for axis 2.
Pwr1_Status	BOOL	FALSE	This variable is assigned to the <i>Status</i> output variable from the PWR1 instance of the MC_Power instruction. This variable changes to TRUE when the Servo is turned ON.
Pwr2_Status	BOOL	FALSE	This variable is assigned to the <i>Status</i> output variable from the PWR2 instance of the MC_Power instruction. This variable changes to TRUE when the Servo is turned ON.

Name	Data type	Default	Comment
StartPg	BOOL	FALSE	The Servos for the axes in the axes group are turned ON if this variable is TRUE and Ether-CAT process data communications are established.
InitFlag	BOOL	FALSE	This variable indicates if it is necessary to set the input parameters. Input parameters are set when this variable is FALSE. When setting the input parameters is completed, this variable changes to TRUE.
Hm1_Ex	BOOL	FALSE	The HM1 instance of MC_Home is executed when this variable changes to TRUE.
Hm2_Ex	BOOL	FALSE	The HM2 instance of MC_Home is executed when this variable changes to TRUE.
Grp_En_Ex	BOOL	FALSE	The GRP_EN instance of MC_GroupEnable is executed when this variable changes to TRUE.
Mv_Lin1_Ex	BOOL	FALSE	The MV_LIN1 instance of MC_MoveLinear is executed when this variable changes to TRUE.
Mv_Lin2_Ex	BOOL	FALSE	The MV_LIN2 instance of MC_MoveLinear is executed when this variable changes to TRUE.
Mv_Circ1_Ex	BOOL	FALSE	The MV_CIRC1 instance of MC_MoveCircular is executed when this variable changes to TRUE.
Mv_Circ2_Ex	BOOL	FALSE	The MV_CIRC2 instance of MC_MoveCircular is executed when this variable changes to TRUE.

## ● Sample Programming

```
// Processing when input parameters are not set
IF InitFlag=FALSE THEN

    //MV_CIRC1 parameters
Mv_Circ1_CircAxes[0] := UINT#0;
Mv_Circ1_CircAxes[1] := UINT#1;
Mv_Circ1_CircMode := _eMC_CIRC_MODE#_mcRadius;
Mv_Circ1_AuxPoint[0] := LREAL#5.0;
Mv_Circ1_AuxPoint[1] := LREAL#0.0;
Mv_Circ1_EndPoint[0] := LREAL#15.0;
Mv_Circ1_EndPoint[1] := LREAL#10.0;
Mv_Circ1_Pc := _eMC_CIRC_PATHCHOICE#_mcCCW;
Mv_Circ1_Vel := LREAL#100.0;
Mv_Circ1_Acc := LREAL#20.0;
Mv_Circ1_Dec := LREAL#20.0;
Mv_Circ1_Bm := _eMC_BUFFER_MODE#_mcBuffered;
Mv_Circ1_Mm := _eMC_MOVE_MODE#_mcAbsolute;

    //MV_CIRC2 parameters
Mv_Circ2_CircAxes[0] := UINT#0;
Mv_Circ2_CircAxes[1] := UINT#1;
```

```

Mv_Circ2_CircMode := _eMC_CIRC_MODE#_mcCenter;
Mv_Circ2_AuxPoint[0] := LREAL#15.0;
Mv_Circ2_AuxPoint[1] := LREAL#20.0;
Mv_Circ2_EndPoint[0] := LREAL#20.0;
Mv_Circ2_EndPoint[1] := LREAL#20.0;
Mv_Circ2_Pc := _eMC_CIRC_PATHCHOICE#_mcCW;
Mv_Circ2_Vel := LREAL#100.0;
Mv_Circ2_Acc := LREAL#20.0;
Mv_Circ2_Dec := LREAL#20.0;
Mv_Circ2_Bm := _eMC_BUFFER_MODE#_mcBuffered;
Mv_Circ2_Mm := _eMC_MOVE_MODE#_mcAbsolute;

//MV_LIN1 parameters
Mv_Lin1_Pos[0] := LREAL#10.0;
Mv_Lin1_Pos[1] := LREAL#5.0;
Mv_Lin1_Vel := LREAL#100.0;
Mv_Lin1_Acc := LREAL#20.0;
Mv_Lin1_Dec := LREAL#20.0;
Mv_Lin1_Mm := _eMC_MOVE_MODE#_mcAbsolute;

//MV_LIN2 parameters
Mv_Lin2_Pos[0] := LREAL#15.0;
Mv_Lin2_Pos[1] := LREAL#15.0;
Mv_Lin2_Vel := LREAL#100.0;
Mv_Lin2_Acc := LREAL#20.0;
Mv_Lin2_Dec := LREAL#20.0;
Mv_Lin2_Bm := _eMC_BUFFER_MODE#_mcBuffered;
Mv_Lin2_Mm := _eMC_MOVE_MODE#_mcAbsolute;

// Change InitFlag to TRUE after setting the input parameters.
InitFlag := TRUE;

END_IF;

// If StartPg is TRUE and the Servo Drive is ready, the Servo for axis 1 is turned
ON.
// If the Servo Drive is not ready, the Servo is turned OFF.
IF (StartPg=TRUE)
  AND (MC_Axis000.DrvStatus.Ready=TRUE) THEN
  Pwr1_En:=TRUE; // Turn ON the Servo for axis 1.
ELSE
  Pwr1_En:=FALSE; // Turn OFF the Servo for axis 1.
END_IF;

// If StartPg is TRUE and the Servo Drive is ready, the Servo for axis 2 is turned
ON.
// If the Servo Drive is not ready, the Servo is turned OFF.

```

```

IF (StartPg=TRUE)
  AND (MC_Axis001.DrvStatus.Ready=TRUE) THEN
    Pwr2_En:=TRUE; // Turn ON the Servo for axis 2.
ELSE
    Pwr2_En:=FALSE; // Turn OFF the Servo for axis 2.
END_IF;

// Processing for a minor fault level error
// Program the FaultHandler according to the device.
IF (MC_Axis000.MFaultLvl.Active=TRUE) OR (MC_Axis001.MFaultLvl.Active=TRUE)
  OR (MC_Group000.MFaultLvl.Active=TRUE) THEN
    FaultHandler();
END_IF;

// If the Servo is ON for axis 1 and home is not defined, the Home instruction is e
xecuted.
IF (Pwr1_Status=TRUE) AND (MC_Axis000.Details.Homed=FALSE) THEN
    Hm1_Ex:=TRUE;
END_IF;

// If the Servo is ON for axis 2 and home is not defined, the Home instruction is e
xecuted.
IF (Pwr2_Status=TRUE) AND (MC_Axis001.Details.Homed=FALSE) THEN
    Hm2_Ex:=TRUE;
END_IF;

// If axes group 0 is disabled after homing is completed for axis 1 and axis 2, it
is enabled.
IF (Hm1_D=TRUE) AND (Hm2_D=TRUE) AND (MC_Group000.Status.Disabled=TRUE) THEN
    Grp_En_Ex:= TRUE;
END_IF;

// If axes group 0 is enabled, linear interpolation (1) is executed.
IF Grp_En_D=TRUE THEN
    Mv_Lin1_Ex:=TRUE;
END_IF;

// The rest of the instructions are executed with multi-execution of instructions w
hen the Active output variable for linear interpolation (1) changes to TRUE.
IF Mv_Lin1_Act=TRUE THEN
    Mv_Circ1_Ex:=TRUE;
    Mv_Lin2_Ex:=TRUE;
    Mv_Circ2_Ex:=TRUE;
END_IF;

// MC_Power for axis 1
PWR1 (

```

```

    Axis := MC_Axis000,
    Enable := Pwr1_En,
    Status => Pwr1_Status,
    Busy => Pwr1_Bsy,
    Error => Pwr1_Err,
    ErrorID => Pwr1_ErrID
);

// MC_Power for axis 2
PWR2(
    Axis := MC_Axis001,
    Enable := Pwr2_En,
    Status => Pwr2_Status,
    Busy => Pwr2_Bsy,
    Error => Pwr2_Err,
    ErrorID => Pwr2_ErrID
);

// MC_Home for axis 1
HM1(
    Axis := MC_Axis000,
    Execute := Hm1_Ex,
    Done => Hm1_D,
    Busy => Hm1_Bsy,
    CommandAborted => Hm1_Ca,
    Error => Hm1_Err,
    ErrorID => Hm1_ErrID
);

// MC_Home for axis 2
HM2(
    Axis := MC_Axis001,
    Execute := Hm2_Ex,
    Done => Hm2_D,
    Busy => Hm2_Bsy,
    CommandAborted => Hm2_Ca,
    Error => Hm2_Err,
    ErrorID => Hm2_ErrID
);

// Axes Group 0 is enabled.
GRP_EN(
    AxesGroup := MC_Group000,
    Execute := Grp_En_Ex,
    Done => Grp_En_D,
    Busy => Grp_En_Bsy,
    CommandAborted => Grp_En_Ca,

```

```

        Error => Grp_En_Err,
        ErrorID => Grp_En_ErrID
    );

// Linear interpolation (1)
MV_LIN1(
    AxesGroup := MC_Group000,
    Execute := Mv_Lin1_Ex,
    Position := Mv_Lin1_Pos,
    Velocity := Mv_Lin1_Vel,
    Acceleration := Mv_Lin1_Acc,
    Deceleration := Mv_Lin1_Dec,
    MoveMode := Mv_Lin1_Mm,
    Done => Mv_Lin1_D,
    Busy => Mv_Lin1_Bsy,
    Active => Mv_Lin1_Act,
    CommandAborted => Mv_Lin1_Ca,
    Error => Mv_Lin1_Err,
    ErrorID => Mv_Lin1_ErrID
);

// Circular interpolation (2)
MV_CIRC1(
    AxesGroup := MC_Group000,
    Execute := Mv_Circl_Ex,
    CircAxes := Mv_Circl_CircAxes,
    CircMode := Mv_Circl_CircMode,
    AuxPoint := Mv_Circl_AuxPoint,
    EndPoint := Mv_Circl_EndPoint,
    PathChoice := Mv_Circl_Pc,
    Velocity := Mv_Circl_Vel,
    Acceleration := Mv_Circl_Acc,
    Deceleration := Mv_Circl_Dec,
    BufferMode := Mv_Circl_Bm,
    MoveMode := Mv_Circl_Mm,
    Done => Mv_Circl_D,
    Busy => Mv_Circl_Bsy,
    Active => Mv_Circl_Act,
    CommandAborted => Mv_Circl_Ca,
    Error => Mv_Circl_Err,
    ErrorID => Mv_Circl_ErrID
);

// Linear interpolation (3)
MV_LIN2(
    AxesGroup := MC_Group000,
    Execute := Mv_Lin2_Ex,

```



```

    Position := Mv_Lin2_Pos,
    Velocity := Mv_Lin2_Vel,
    Acceleration := Mv_Lin2_Acc,
    Deceleration := Mv_Lin2_Dec,
    BufferMode := Mv_Lin2_Bm,
    MoveMode := Mv_Lin2_Mm,
    Done => Mv_Lin2_D,
    Busy => Mv_Lin2_Bsy,
    Active => Mv_Lin2_Act,
    CommandAborted => Mv_Lin2_Ca,
    Error => Mv_Lin2_Err,
    ErrorID => Mv_Lin2_ErrID
);

// Circular interpolation (4)
MV_CIRC2(
    AxesGroup := MC_Group000,
    Execute := Mv_Circ2_Ex,
    CircAxes := Mv_Circ2_CircAxes,
    CircMode := Mv_Circ2_CircMode,
    AuxPoint := Mv_Circ2_AuxPoint,
    EndPoint := Mv_Circ2_EndPoint,
    PathChoice := Mv_Circ2_Pc,
    Velocity := Mv_Circ2_Vel,
    Acceleration := Mv_Circ2_Acc,
    Deceleration := Mv_Circ2_Dec,
    BufferMode := Mv_Circ2_Bm,
    MoveMode := Mv_Circ2_Mm,
    Done => Mv_Circ2_D,
    Busy => Mv_Circ2_Bsy,
    Active => Mv_Circ2_Act,
    CommandAborted => Mv_Circ2_Ca,
    Error => Mv_Circ2_Err,
    ErrorID => Mv_Circ2_ErrID
);

```

# MC\_GroupStop

The MC\_GroupStop instruction decelerates all of the axes in an interpolated motion to a stop.

Instruction	Name	FB/ FUN	Graphic expression	ST expression
MC_GroupStop	Group Stop	FB		<pre>MC_GroupStop_instance (   AxesGroup :=parameter,   Execute :=parameter,   Deceleration :=parameter,   Jerk :=parameter,   BufferMode :=parameter,   Done =&gt;parameter,   Busy =&gt;parameter,   Active =&gt;parameter,   CommandAborted =&gt;parameter,   Error =&gt;parameter,   ErrorID =&gt;parameter );</pre>

## Variables

### Input Variables

Name	Meaning	Data type	Valid range	De- fault	Description
Execute	Execute	BOOL	TRUE or FALSE	FALS E	The instruction is executed when the value of this variable changes to TRUE.
Deceleration	Decelera- tion Rate	LREAL	Non-negative num- ber	0	Specify the deceleration rate. The unit is command units/s <sup>2</sup> . *1
Jerk	Jerk	LREAL	Non-negative num- ber	0	Specify the jerk. The unit is command units/s <sup>3</sup> . *1
BufferMode	Buffer Mode Se- lection	_eMC_BUF- FER_MODE	0: _mcAborting	0*2	Specify the behavior when executing more than one motion instruction. 0: Aborting

\*1. Refer to *Unit Conversion Settings* in the *NJ/NX-series CPU Unit Motion Control User's Manual (Cat. No. W507)* for information on command units.

\*2. The default value for an enumeration variable is actually not the number, but the enumerator.

### Output Variables

Name	Meaning	Data type	Valid range	Description
Done	Done	BOOL	TRUE or FALSE	TRUE when the instruction is completed.
Busy	Executing	BOOL	TRUE or FALSE	TRUE when the instruction is acknowledged.

Name	Meaning	Data type	Valid range	Description
Active	Controlling	BOOL	TRUE or FALSE	TRUE when the axis is being controlled.
CommandAborted	Command Aborted	BOOL	TRUE or FALSE	TRUE when the instruction is aborted.
Error	Error	BOOL	TRUE or FALSE	TRUE while there is an error.
ErrorID	Error Code	WORD	*1	Contains the error code when an error occurs. A value of 16#0000 indicates normal execution.

\*1. The upper four digits of the event code give the error code for ErrorID. Refer to the *NJ/NX-series Troubleshooting Manual (Cat. No. W503)* for the event codes.

### ● Output Variable Update Timing

Name	Timing for changing to TRUE	Timing for changing to FALSE
Done	When the instruction is completed.	<ul style="list-style-type: none"> <li>When <i>Execute</i> is TRUE and changes to FALSE.</li> <li>After one period when <i>Execute</i> is FALSE.</li> </ul>
Busy	When <i>Execute</i> changes to TRUE.	<ul style="list-style-type: none"> <li>When <i>Done</i> changes to TRUE.</li> <li>When <i>Error</i> changes to TRUE.</li> <li>When <i>CommandAborted</i> changes to TRUE.</li> </ul>
Active	When the instruction is started.	<ul style="list-style-type: none"> <li>When <i>Done</i> changes to TRUE.</li> <li>When <i>Error</i> changes to TRUE.</li> <li>When <i>CommandAborted</i> changes to TRUE.</li> </ul>
CommandAborted	<ul style="list-style-type: none"> <li>When this instruction is aborted because another motion control instruction was executed with the Buffer Mode set to <b>Aborting</b>.</li> <li>When this instruction is canceled due to an error.</li> <li>When this instruction is executed while there is an error.</li> </ul>	<ul style="list-style-type: none"> <li>When <i>Execute</i> is TRUE and changes to FALSE.</li> <li>After one period when <i>Execute</i> is FALSE.</li> </ul>
Error	When there is an error in the execution conditions or input parameters for the instruction.	When the error is cleared.

## In-Out Variables

Name	Meaning	Data type	Valid range	Description
AxesGroup	Axes Group	_sGROUP_REF	---	Specify the axes group. *1

\*1. Specify a user-defined Axes Group Variable that was created in the Axes Group Basic Settings of the Sysmac Studio (default: MC\_Group\*) or a system-defined axes group variable name (`_MC_GRP[*]`, `_MC1_GRP[*]`, or `_MC2_GRP[*]`). If you use Sysmac Studio version 1.29 or higher, you can specify the system-defined axes group variable name for AT specification of a user-defined variable. This will allow you to specify the user-defined variable. If you use Sysmac Studio version 1.28 or lower, do not specify any user-defined variable created in the variable table.

## Function

- This instruction stops all of the axes that are in motion for an axes group instruction (i.e., all of the axes in the axes group that is specified with *AxesGroup*), and then disables the axes group instruction.

The following instructions use *Deceleration* (Deceleration Rate) to decelerate the axis to a stop: MC\_MoveLinear (Linear Interpolation), MC\_MoveLinearAbsolute (Absolute Linear Interpolation), MC\_MoveLinearRelative (Relative Linear Interpolation), and MC\_MoveCircular2D (Circular 2D Interpolation).

The MC\_GroupSyncMoveAbsolute (Axes Group Cyclic Synchronous Absolute Positioning) instruction uses an immediate stop to stop the axis. It is not affected by *Deceleration* (Deceleration Rate).

- *CommandAborted* for the interpolation instruction that is currently in operation will change to TRUE when this instruction is executed.
- If you execute this instruction while an interpolation instruction is in execution, the axes will decelerate to a stop along the linear interpolation or circular interpolation path.
- The deceleration stop operation starts when *Execute* changes to TRUE.



### Precautions for Correct Use

This instruction is not executed if *Status.ErrorStop* (Error Deceleration Stopping) in the Axes Group Variable is TRUE.

Use the MC\_GroupImmediateStop instruction to stop the motion of an axes group that is decelerating to a stop for an error.

## Instruction Details

This section describes the instruction in detail.

### ● Deceleration (Deceleration Rate) and Jerk

Set the input variables, *Deceleration* (Deceleration Rate) and *Jerk*, to set the deceleration rate and jerk when decelerating to a stop.

When this instruction is executed, *Deceleration* (Deceleration Rate) and *Jerk* specified for this instruction are used for the interpolation velocity.

#### Jerk

The relationships between the deceleration rate and interpolation velocity when *Jerk* is set to 0 and when it is set to any other value are shown below.

- *Jerk* Set to 0

The command value for the velocity is created with deceleration rate Dt.

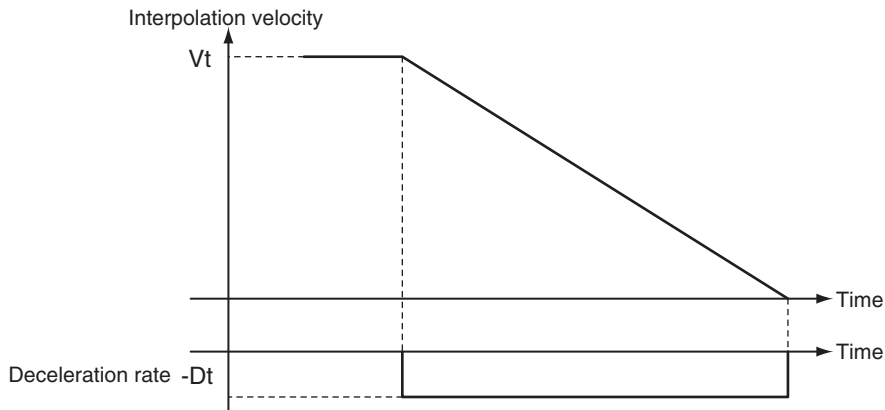

$V_t$ : Velocity when deceleration starts,  $Dt$ : Specified deceleration rate

- **Jerk Set to Value Other Than 0**

The command value for the velocity is created based on the current velocity with  $Dt$  as the upper limit to the deceleration rate.

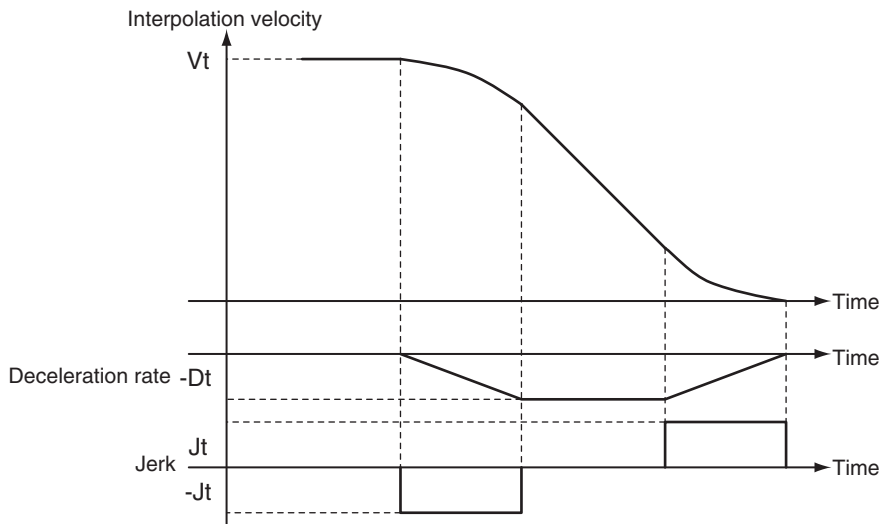

$V_t$ : Velocity when deceleration starts,  $Dt$ : Specified deceleration rate,  $J_t$ : Specified jerk



#### Additional Information

- If 0 is specified for *Deceleration* (Deceleration Rate), an immediate stop is performed and the axis stops immediately.
- An immediate stop occurs regardless of the setting of the **Acceleration/Deceleration Over** axis parameter only when *Deceleration* (Deceleration Rate) is set to 0.

#### ● BufferMode (Buffer Mode Selection)

This variable specifies how to join the axis motions for this interpolation instruction and the previous interpolation instruction.

There is only the following setting.

Buffer Mode Selection	Description
Aborting	Aborts the instruction being executed and executes this instruction.

For details on *BufferMode* (Buffer Mode Selection), refer to the *NJ/NX-series CPU Unit Motion Control User's Manual (Cat. No. W507)*.

## ● In-position Check

An in-position check is not performed when stopping for this instruction.

## Timing Charts

- *Busy* (Executing) changes to TRUE at the same time as *Execute* changes to TRUE. *Active* (Controlling) changes to TRUE in the next period.
- *Done* changes to TRUE when a velocity of 0 is reached.
- If another instruction aborts this instruction, *CommandAborted* changes to TRUE and *Busy* (Executing) and *Active* (Controlling) change to FALSE.

The following chart shows decelerating to a stop for linear interpolation.

*CommandAborted* for the interpolation instruction that is currently in operation will change to TRUE when this instruction is executed.

Previous Instruction: MC\_MoveLinear

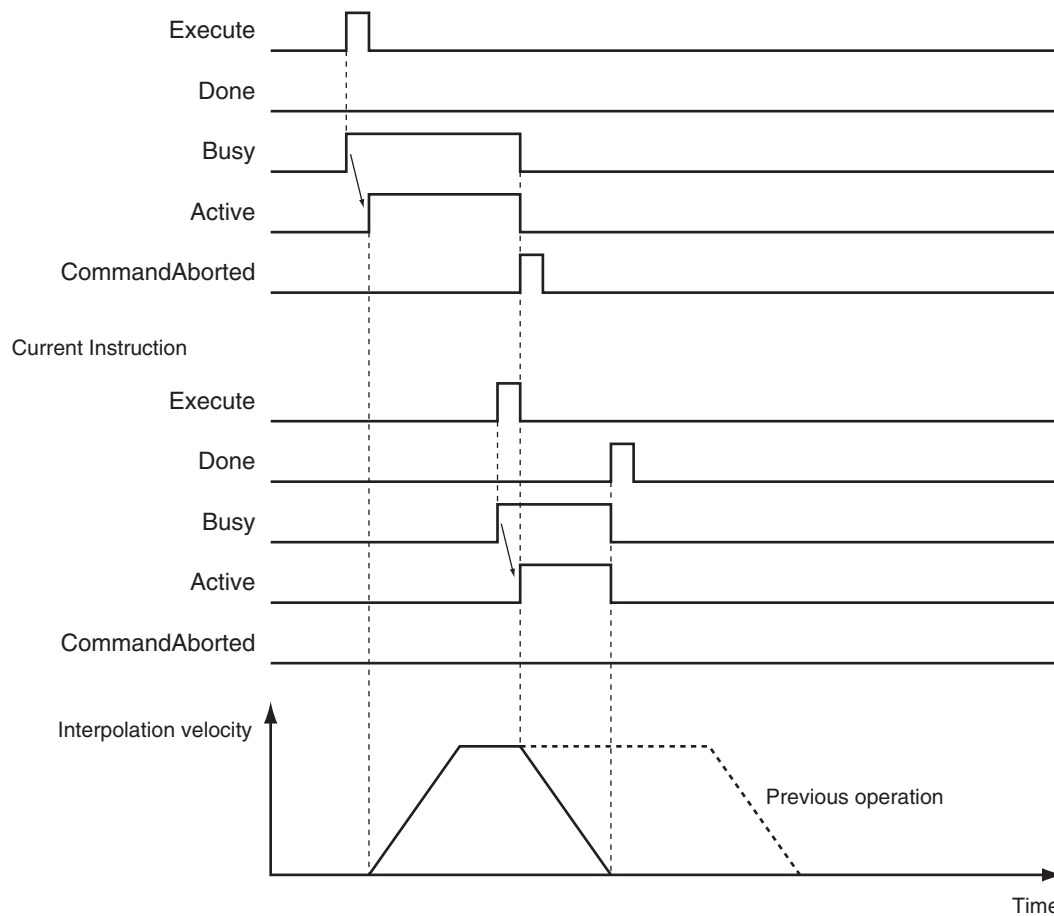

## Re-execution of Motion Control Instructions

The deceleration rate changes if *Execute* changes to TRUE again while this instruction is being executed.

The *Jerk* setting is not changed when a motion control instruction is re-executed.

### ● Jerk Set to Value Other Than 0

The velocity command value is created with  $Dt2$  as the upper limit of the deceleration rate after it has changed based on the actual velocity and actual deceleration rate.

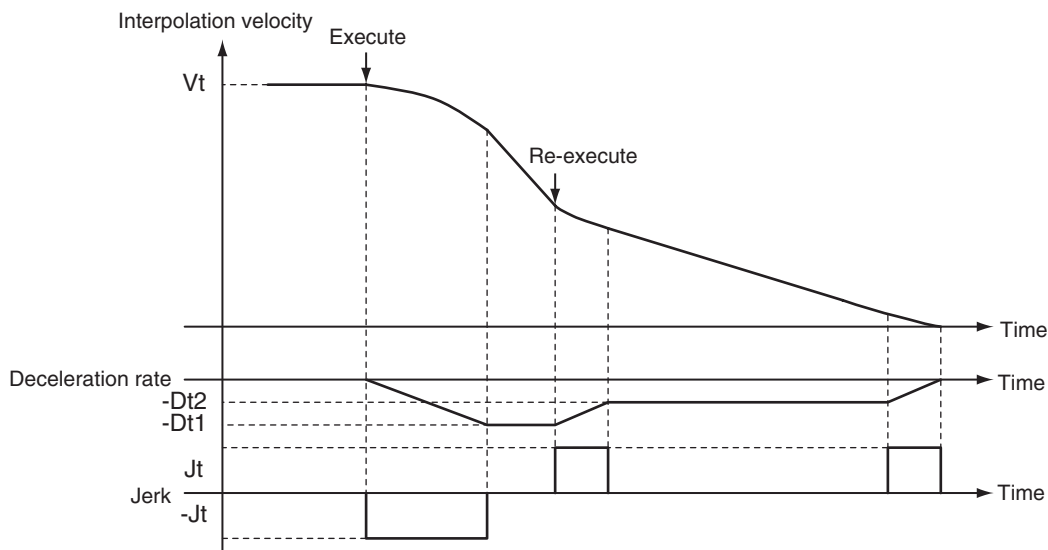

$V_t$ : Velocity when deceleration starts,  $Dt$ : Specified deceleration rate,  $J_t$ : Specified jerk

## Multi-execution of Motion Control Instructions

There are restrictions to execution of this instruction, and to other instructions executed during execution of this instruction.

For details on multi-execution of motion control instructions, refer to the *NJ/NX-series CPU Unit Motion Control User's Manual (Cat. No. W507)*.

### ● Execution during Execution of Other Instructions

#### When Axes Group Is Disabled

An error occurs for the axes group if the `MC_GroupStop` instruction is executed for a disable axes group. However, this will not affect the axes.

#### When the *Status.Stopping* (Deceleration Stopping) in the Axes Group Variable Is TRUE

*Status.Stopping* (Deceleration Stopping) in the Axis Variable changes to TRUE in the following cases.

- While the axes group is decelerating for the `MC_GroupStop` Instruction
- While *Execute* is TRUE for one or more `MC_GroupStop` instructions

If you execute one of the following instructions for an axes group that is decelerating to a stop, *CommandAborted* of the executed instruction changes to TRUE.

- `MC_MoveLinear` (Linear Interpolation) instruction

- MC\_MoveLinearAbsolute (Absolute Linear Interpolation) instruction
- MC\_MoveLinearRelative (Relative Linear Interpolation) instruction
- MC\_MoveCircular2D (Circular 2D Interpolation) instruction

When the MC\_GroupStop instruction is in execution, you can execute another MC\_GroupStop instruction with multi-execution of instructions. *Done* from the MC\_GroupStop instruction that is in execution changes to TRUE.

**When the *Status.ErrorStop* (Error Deceleration Stopping) in the Axes Group Variable Is TRUE**  
*Status.ErrorStop* (Error Deceleration Stopping) in the axes group status is TRUE while there is an error for the axes group.

If the MC\_GroupStop instruction is executed when *Status.ErrorStop* (Error Deceleration Stopping) is TRUE, *CommandAborted* changes to TRUE.

Use the MC\_GroupImmediateStop (Axes Group Stop) instruction instead.

## Errors

If an error occurs during instruction execution, *Error* will change to TRUE.

You can find out the cause of the error by referring to the value output by *ErrorID* (Error Code).

Previous Instruction: MC\_MoveLinear

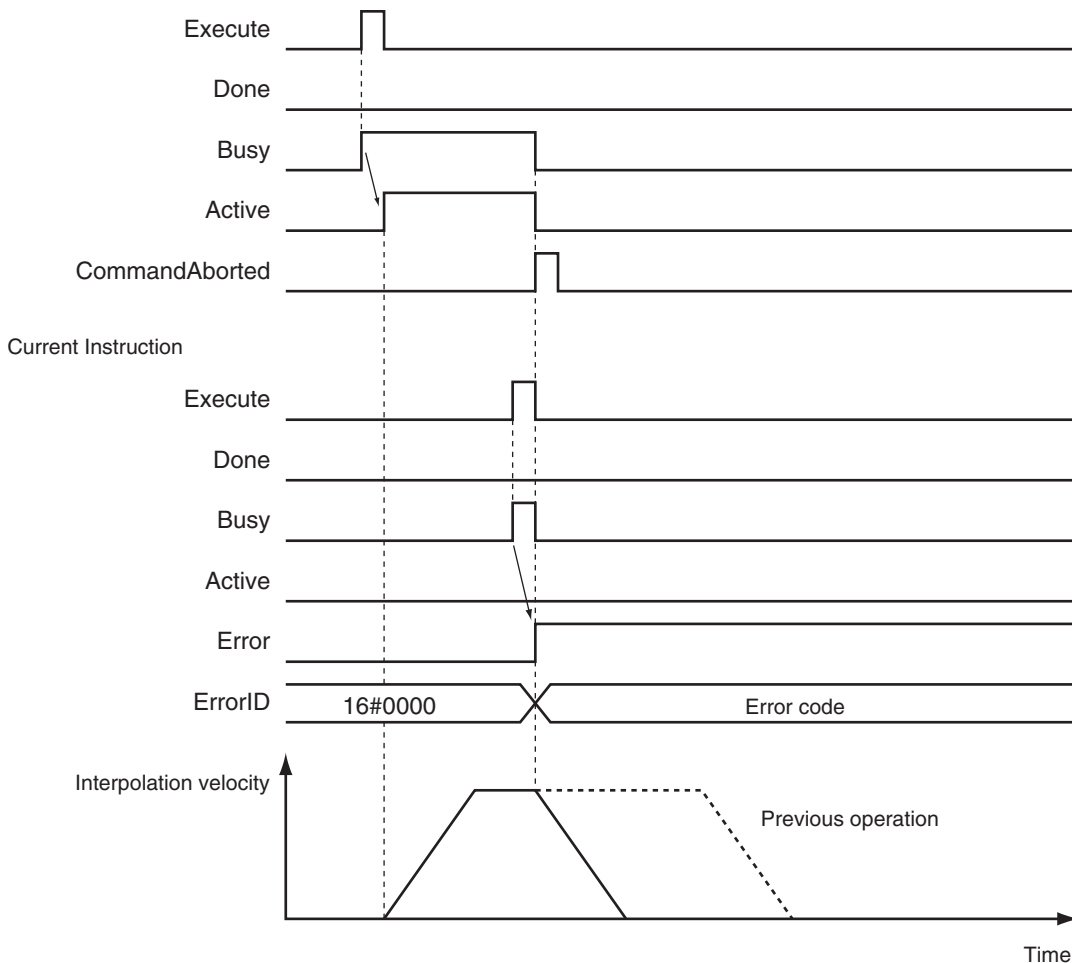



## Version Information

Operation when an error is reset depends on the unit version of the CPU Unit as follows:  
Note that you must reset errors only after the axis has stopped. Do not reset errors during axis motion.

- **A CPU Unit with unit version 1.10 or later:**

If you clear the error for this instruction, the instruction will not start until *Execute* changes to TRUE again.

**Ver. 1.10 or Later**

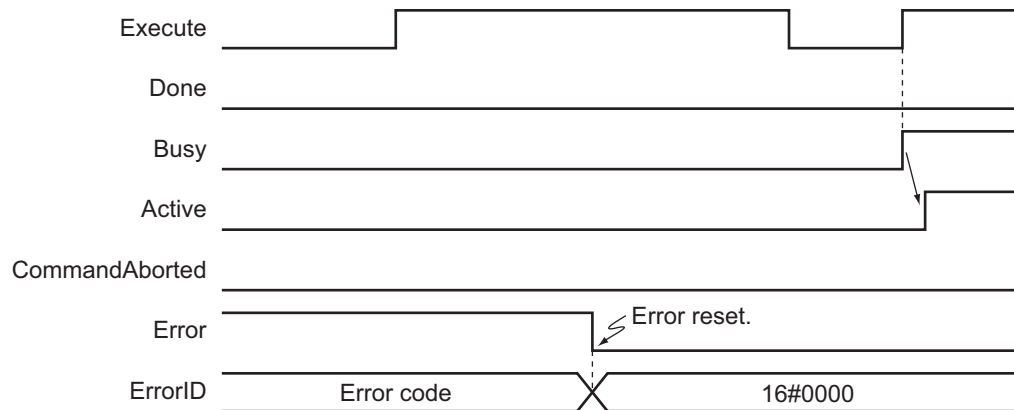

- **A CPU Unit with unit version 1.09 or earlier:**

If an error occurs for this instruction and the error is reset while *Execute* is TRUE, operation will be performed as follows.

- If the cause of the error has already been removed, *Error* changes to FALSE and *Done* changes to TRUE. *Status.Stopping* (Deceleration Stopping) in the Axis Variable changes to TRUE in the same way as for normal execution of the deceleration stop.
- If the cause of the error has not been removed, *Error* changes to TRUE again for this instruction and an axis error occurs.

In the following timing chart, the cause of the error is removed.

**Ver. 1.09 or Earlier**

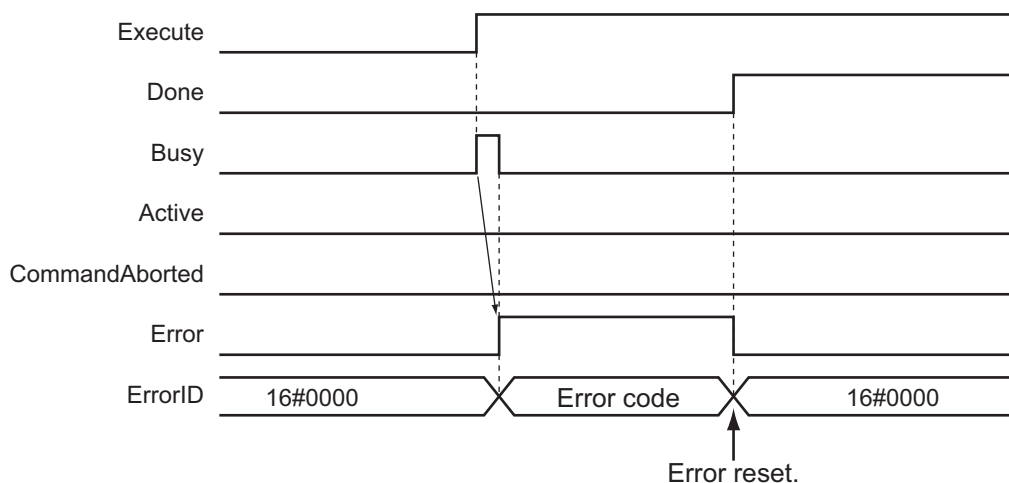

## ● Error Codes

Refer to the *NJ/NX-series Troubleshooting Manual (Cat. No. W503)* for instruction errors.

# MC\_GroupImmediateStop

The MC\_GroupImmediateStop instruction stops all axes in an interpolated motion.

If the specified axes group is enabled, all of the composition axes are stopped according to the stop mode that is specified in the **Immediate Stop Input Stop Method** axis parameter regardless of the current status of the axes.

Instruction	Name	FB/ FU N	Graphic expression	ST expression
MC_GroupImmediate- Stop	Axes Group Immedi- ate Stop	FB		<pre>MC_GroupImmediateStop_instance (   AxesGroup :=parameter,   Execute :=parameter,   Done =&gt;parameter,   Busy =&gt;parameter,   CommandAborted =&gt;parameter,   Error =&gt;parameter,   ErrorID =&gt;parameter );</pre>

## Variables

### Input Variables

Name	Meaning	Data type	Valid range	Default	Description
Execute	Execute	BOOL	TRUE or FALSE	FALSE	The instruction is executed when the value of this variable changes to TRUE.

### Output Variables

Name	Meaning	Data type	Valid range	Description
Done	Done	BOOL	TRUE or FALSE	TRUE when the instruction is completed.
Busy	Executing	BOOL	TRUE or FALSE	TRUE when the instruction is acknowledged.
CommandAborted	Command Aborted	BOOL	TRUE or FALSE	TRUE when the instruction is aborted.
Error	Error	BOOL	TRUE or FALSE	TRUE while there is an error.
ErrorID	Error Code	WORD	*1	Contains the error code when an error occurs. A value of 16#0000 indicates normal execution.

\*1. The upper four digits of the event code give the error code for ErrorID. Refer to the *NJ/NX-series Troubleshooting Manual (Cat. No. W503)* for the event codes.

## ● Output Variable Update Timing

Name	Timing for changing to TRUE	Timing for changing to FALSE
Done	When the immediate stop is completed.	<ul style="list-style-type: none"> <li>When <i>Execute</i> is TRUE and changes to FALSE.</li> <li>After one period when <i>Execute</i> is FALSE.</li> </ul>
Busy	When <i>Execute</i> changes to TRUE.	<ul style="list-style-type: none"> <li>When <i>Done</i> changes to TRUE.</li> <li>When <i>Error</i> changes to TRUE.</li> <li>When <i>CommandAborted</i> changes to TRUE.</li> </ul>
CommandAborted	<ul style="list-style-type: none"> <li>When this instruction is canceled because another MC_GroupStop instruction was executed with the Buffer Mode set to <b>Aborting</b>.</li> <li>When this instruction is canceled due to an error.</li> </ul>	<ul style="list-style-type: none"> <li>When <i>Execute</i> is TRUE and changes to FALSE.</li> <li>After one period when <i>Execute</i> is FALSE.</li> </ul>
Error	When there is an error in the execution conditions or input parameters for the instruction.	When the error is cleared.

## In-Out Variables

Name	Meaning	Data type	Valid range	Description
AxesGroup	Axes Group	_sGROUP_RE EF	---	Specify the axes group. *1

- \*1. Specify a user-defined Axes Group Variable that was created in the Axes Group Basic Settings of the Sysmac Studio (default: MC\_Group\*) or a system-defined axes group variable name (\_MC\_GRP[\*], \_MC1\_GRP[\*], or \_MC2\_GRP[\*]). If you use Sysmac Studio version 1.29 or higher, you can specify the system-defined axes group variable name for AT specification of a user-defined variable. This will allow you to specify the user-defined variable. If you use Sysmac Studio version 1.28 or lower, do not specify any user-defined variable created in the variable table.

## Function

- You can execute the MC\_GroupImmediateStop instruction for an entire axes group that is in motion for an axes group instruction (i.e., the axes in the axes group that is specified with *AxesGroup*) or for an axes group that is stopping for the MC\_GroupStop instruction or error.
- When this instruction is executed, the axis stops immediately according to the setting of the **Immediate Stop Input Stop Method** axis parameter. *CommandAborted* changes to TRUE for the instruction that is currently in operation.
- When the instruction is executed, *Status.ErrorStop* (Error Deceleration Stopping) in the axis status changes to TRUE and an Axes Group Immediate Stop Instruction Executed error (error code: 5486 hex) occurs when the instruction is executed.

For details on the Axes Group Immediate Stop Instruction Executed error (error code: 5486 hex), refer to the *NJ/NX-series CPU Unit Motion Control User's Manual (Cat. No. W507)*.

## Timing Charts

- Busy* (Executing) changes to TRUE when *Execute* changes to TRUE.
- Done* changes to TRUE when processing of this instruction is completed.

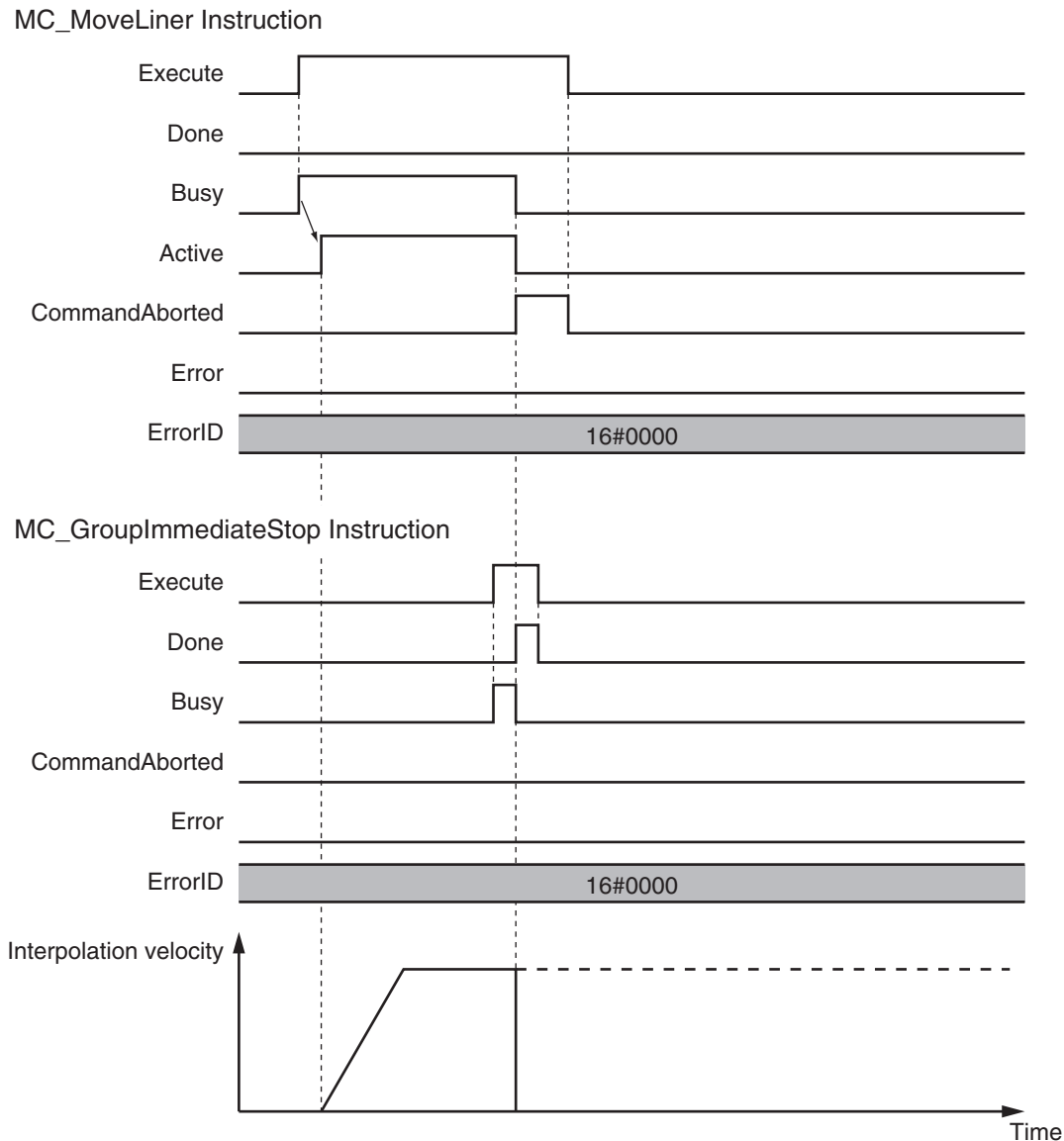

## Re-execution of Motion Control Instructions

This instruction cannot be re-executed.

A Motion Control Instruction Re-execution Disabled error (error code: 543B hex) occurs if re-execution is attempted, and the axis stops.

## Multi-execution of Motion Control Instructions

For details on multi-execution of motion control instructions, refer to the *NJ/NX-series CPU Unit Motion Control User's Manual (Cat. No. W507)*.

### ● Execution during Execution of Other Instructions

#### When the Axes Group Is Disabled

An axes group error will occur if this instruction is executed for a disabled axes group. However, this will not affect the axes.

**When the *Status.Stopping* (Deceleration Stopping) in the Axes Group Variable Is TRUE**

*Status.Stopping* (Deceleration Stopping) in the Axes Group Variable changes to TRUE in the following cases.

- While the axis is decelerating for the MC\_GroupStop Instruction
- While *Execute* is TRUE for one or more MC\_GroupStop instructions

You can execute this instruction for an axes group that is currently decelerating to a stop.

When this instruction is executed, *CommandAborted* for the MC\_GroupStop instruction that is in operation will change to TRUE.

**When the *Status.ErrorStop* (Error Deceleration Stopping) in the Axes Group Variable Is TRUE**

*Status.ErrorStop* (Error Deceleration Stopping) in the axes group status is TRUE while there is an error for the axes group.

You can also execute this instruction for an axes group that is decelerating to a stop for an error.

## Errors

If an error occurs during instruction execution, *Error* will change to TRUE.

You can find out the cause of the error by referring to the value output by *ErrorID* (Error Code).

### ● Error Codes

Refer to the *NJ/NX-series Troubleshooting Manual (Cat. No. W503)* for instruction errors.

# MC\_GroupSetOverride

The MC\_GroupSetOverride instruction changes the combined target velocity during an interpolated motion.

Instruction	Name	FB/ FUN	Graphic expression	ST expression
MC_GroupSetOverride	Set Group Overrides	FB		<pre>MC_GroupSetOverride_instance (   AxesGroup :=parameter,   Enable :=parameter,   VelFactor :=parameter,   AccFactor :=parameter,   JerkFactor :=parameter,   Enabled =&gt;parameter,   Busy =&gt;parameter,   Error =&gt;parameter,   ErrorID =&gt;parameter );</pre>

## Variables

### Input Variables

Name	Meaning	Data type	Valid range	De- fault	Description
Enable	Enable	BOOL	TRUE or FALSE	FALS E	The override factors are enabled when the value of this variable is TRUE. The override factors return to 100% when the value of this variable changes to FALSE.
VelFactor	Velocity Override Factor	LREAL	0 to 500	100	Specify the velocity override factor. The valid range of the override factor is between 0.01 and 500.00. Values above 500.00 are treated as 500 and values less than 0.01 (including negative values) are treated as 0.01. The override factor will be 0 only when 0 is specified. The unit is %.
AccFactor (Reserved)	Acceleration/ Deceleration Override Factor	LREAL	0 to 500	100	(Reserved)
JerkFactor (Reserved)	Jerk Override Factor	LREAL	0 to 500	100	(Reserved)

## Output Variables

Name	Meaning	Data type	Valid range	Description
Enabled	Enabled	BOOL	TRUE or FALSE	TRUE when the axis is being controlled.
Busy	Executing	BOOL	TRUE or FALSE	TRUE when the instruction is acknowledged.
Error	Error	BOOL	TRUE or FALSE	TRUE while there is an error.
ErrorID	Error Code	WORD	*1	Contains the error code when an error occurs. A value of 16#0000 indicates normal execution.

\*1. The upper four digits of the event code give the error code for ErrorID. Refer to the *NJ/NX-series Troubleshooting Manual (Cat. No. W503)* for the event codes.

### ● Output Variable Update Timing

Name	Timing for changing to TRUE	Timing for changing to FALSE
Enabled	When <i>Enable</i> changes to TRUE.	<ul style="list-style-type: none"> <li>After one period when <i>Enable</i> is FALSE.</li> <li>When <i>Error</i> changes to TRUE.</li> </ul>
Busy	When <i>Enable</i> changes to TRUE.	<ul style="list-style-type: none"> <li>When <i>Error</i> changes to TRUE.</li> </ul>
Error	When there is an error in the execution conditions or input parameters for the instruction.	When the error is cleared.

## In-Out Variables

Name	Meaning	Data type	Valid range	Description
AxesGroup	Axes Group	_sGROUP_RE EF	---	Specify the axes group. *1

\*1. Specify a user-defined Axes Group Variable that was created in the Axes Group Basic Settings of the Sysmac Studio (default: MC\_Group\*) or a system-defined axes group variable name (`_MC_GRP[*]`, `_MC1_GRP[*]`, or `_MC2_GRP[*]`). If you use Sysmac Studio version 1.29 or higher, you can specify the system-defined axes group variable name for AT specification of a user-defined variable. This will allow you to specify the user-defined variable. If you use Sysmac Studio version 1.28 or lower, do not specify any user-defined variable created in the variable table.

## Function

- This instruction changes the override factors related to the interpolation target velocity for the group controlled by the next instruction.

Changes the target velocity of the axes in operation by changing the override factors.

The override factors apply to the following instructions.

MC_MoveLinear (Linear Interpolation) instruction	MC_MoveLinearRelative (Relative Linear Interpolation) instruction
MC_MoveLinearAbsolute (Absolute Linear Interpolation) instruction	MC_MoveCircular2D (Circular 2D Interpolation) instruction

- The following is the new target velocity.

Target velocity after the change = Interpolation velocity of the current instruction × Override factor (%)

- The unit for override factors is %. A setting of 100 indicates 100%.
- If the interpolation velocity that results from the override exceeds the maximum interpolation velocity set in the Axes Group Variables, the maximum interpolation velocity is used.
- The axis will accelerate or decelerate to the interpolation velocity that results from the override.
- If the velocity override factor is set to 0, the target velocity will be 0. Axes group operation will decelerate to a velocity of 0, and operation will continue. *Status.Moving* in the Axes Group Variable is TRUE during axes group motion.

If you want to pause the axis motion while keeping the operation status, set the override factor to 0.

- The override factors will return to 100% when *Enable* changes to FALSE.
- If an axes group error occurs during MC\_GroupSetOverride execution, the value of *Enabled* for MC\_GroupSetOverride is maintained.



### Precautions for Correct Use

---

When *Enable* to this instruction changes to FALSE, *Enabled* and *Busy* from this instruction change to FALSE.

The axis will accelerate or decelerate to a velocity with a 100% override factor.

---



### Additional Information

---

#### Influence on Other Instructions

Use this instruction to temporarily change the target velocities of other instructions.

This instruction does nothing for instructions to which a target velocity is not input.

However, *Enabled* remains TRUE even if the MC\_GroupSetOverride instruction is executed for an instruction to which it does not apply.

---



## Timing Charts

### ● Using this Instruction for the MC\_MoveLinear (Linear Interpolation) Instruction

Previous Instruction: MC\_MoveLinear

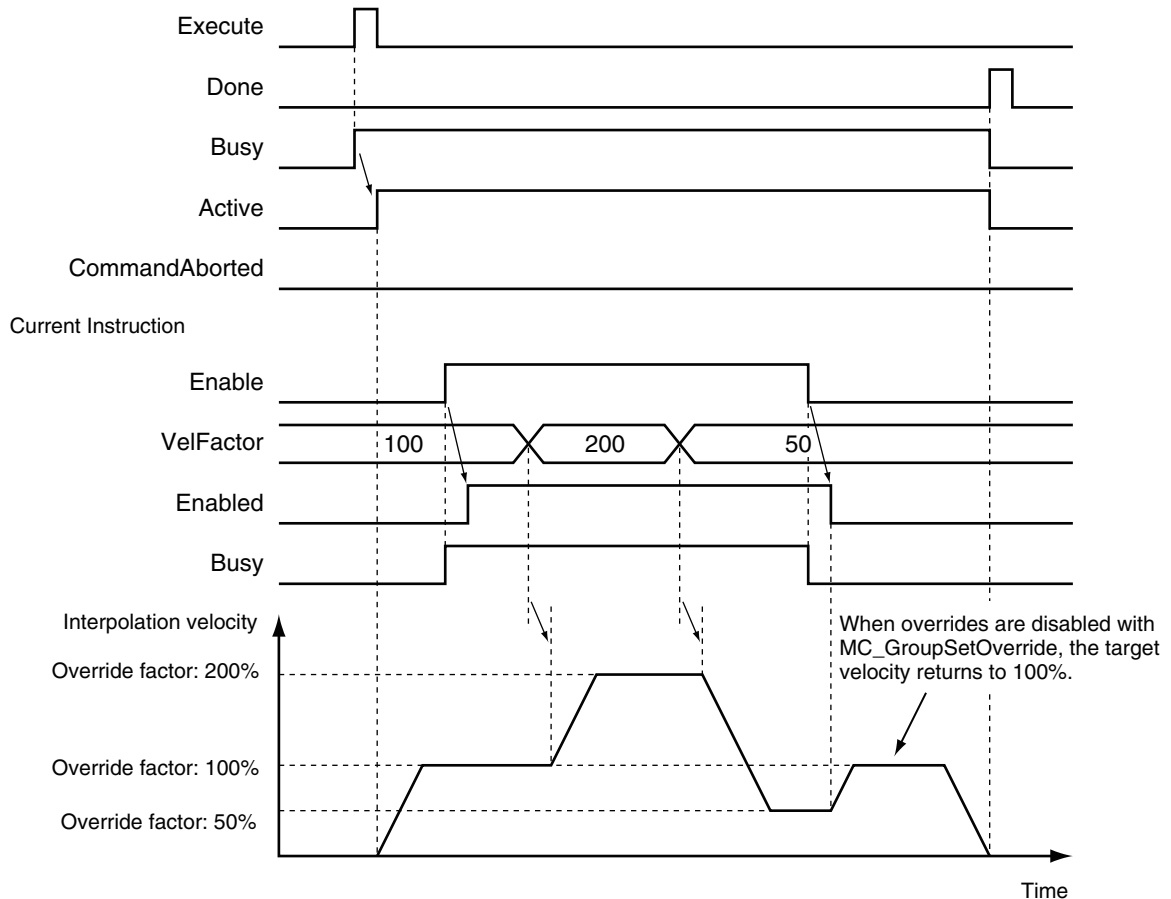

## Re-execution of Motion Control Instructions

You cannot re-execute motion instructions with enable-type inputs.

## Multi-execution of Motion Control Instructions

For details on multi-execution of motion control instructions, refer to the *NJ/NX-series CPU Unit Motion Control User's Manual (Cat. No. W507)*.

### ● Execution of Other Instructions during Instruction Execution

If another instance of the MC\_GroupSetOverride instruction is executed during MC\_GroupSetOverride execution for the same axes group, the last instance that is executed takes priority in processing. *Enabled* will be TRUE for both instructions.

Concretely, the override values of the instance that was executed last are valid. If *Enable* to the instance that was executed last changes to FALSE, the overrides are disabled.

## Errors

If an error occurs during instruction execution, *Error* will change to TRUE.

You can find out the cause of the error by referring to the value output by *ErrorID* (Error Code).

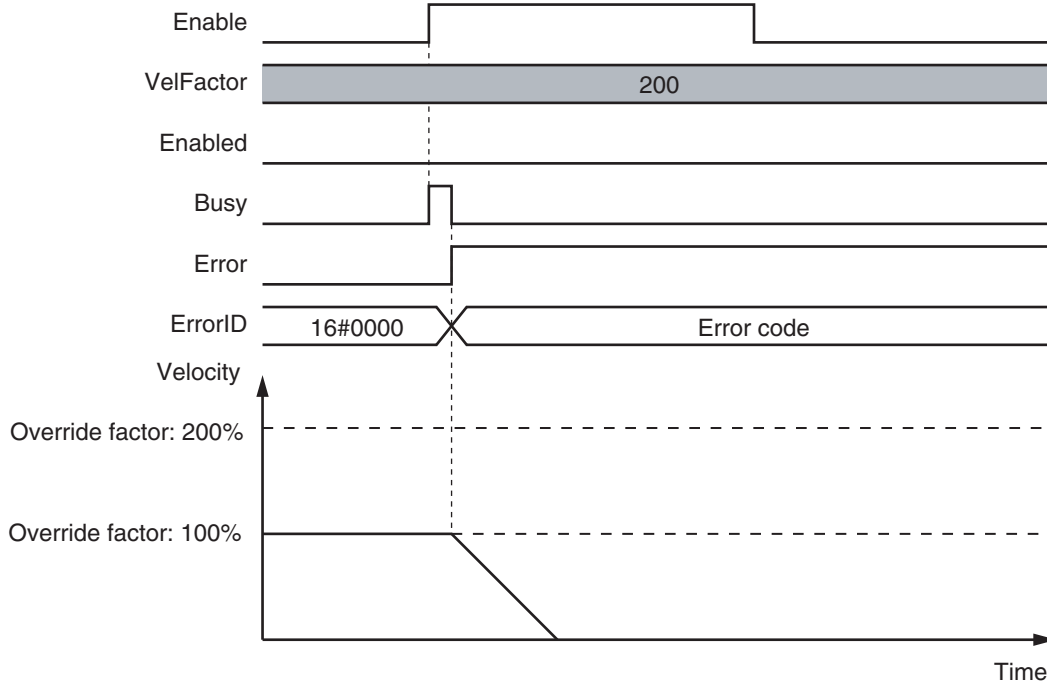

### ● Error Codes

Refer to the *NJ/NX-series Troubleshooting Manual (Cat. No. W503)* for instruction errors.

# MC\_GroupReadPosition

The MC\_GroupReadPosition instruction gets the command current positions and the actual current positions of an axes group.

Instruction	Name	FB/ FUN	Graphic expression	ST expression
MC_GroupRead- Position	Read Axes Group Posi- tion	FB		<pre>MC_GroupReadPosition_instance (   AxesGroup :=parameter,   Enable :=parameter,   CoordSystem :=parameter,   Valid =&gt;parameter,   Busy =&gt;parameter,   Error =&gt;parameter,   ErrorID =&gt;parameter,   CommandPosition =&gt;parameter,   ActualPosition =&gt;parameter );</pre>



## Version Information

A CPU Unit with unit version 1.01 or later and Sysmac Studio version 1.02 or higher are required to use this instruction.

## Variables

### Input Variables

Name	Meaning	Data type	Valid range	Default	Description
Enable	Enable	BOOL	TRUE or FALSE	FALSE	The instruction is executed when the value of this variable changes to TRUE.
CoordSystem	Coordinate System	_eMC_COORD_SYSTEM	0: _mcACS	0*1	Specify the coordinate system. 0: Axis coordinate system (ACS)

\*1. The default value for an enumeration variable is actually not the number, but the enumerator.

### Output Variables

Name	Meaning	Data type	Valid range	Description
Valid	Enabled	BOOL	TRUE or FALSE	TRUE when the axis group is being controlled.
Busy	Executing	BOOL	TRUE or FALSE	TRUE when the instruction is acknowledged.
Error	Error	BOOL	TRUE or FALSE	TRUE while there is an error.

Name	Meaning	Data type	Valid range	Description
ErrorID	Error Code	WORD	*1	Contains the error code when an error occurs. A value of 16#0000 indicates normal execution.
CommandPosition	Command Current Position	ARRAY [0..3] OF LREAL	Negative number, positive number, or 0	Contains the current value of the command position. The unit is command units. *2
ActualPosition	Actual Current Position	ARRAY [0..3] OF LREAL	Negative number, positive number, or 0	Contains the actual current position. The unit is command units. *2

\*1. The upper four digits of the event code give the error code for ErrorID. Refer to the *NJ/NX-series Troubleshooting Manual (Cat. No. W503)* for the event codes.

\*2. Refer to *Unit Conversion Settings* in the *NJ/NX-series CPU Unit Motion Control User's Manual (Cat. No. W507)* for information on command units.

**Note 1.** When the axis composition of the axes group contains two or three axes, the values in *CommandPosition* (Command Current Position) and *ActualPosition* (Actual Current Position) for the composition axes that are not used are not defined.

**Note 2.** When *Enable* changes to FALSE, the values in *CommandPosition* (Command Current Position) and *ActualPosition* (Actual Current Position) are not defined.

## ● Output Variable Update Timing

Name	Timing for changing to TRUE	Timing for changing to FALSE
Valid	When <i>Enable</i> changes to TRUE.	<ul style="list-style-type: none"> <li>When <i>Enable</i> changes to FALSE.</li> <li>When <i>Error</i> changes to TRUE.</li> </ul>
Busy	When <i>Enable</i> changes to TRUE.	When <i>Error</i> changes to TRUE.
Error	When there is an error in the execution conditions or input parameters for the instruction.	When the error is cleared.

## In-Out Variables

Name	Meaning	Data type	Valid range	Description
AxesGroup	Axes Group	_sGROUP_R EF	---	Specify the axes group. *1

\*1. Specify a user-defined Axes Group Variable that was created in the Axes Group Basic Settings of the Sysmac Studio (default: MC\_Group\*) or a system-defined axes group variable name (\_MC\_GRP[\*], \_MC1\_GRP[\*], or \_MC2\_GRP[\*]). If you use Sysmac Studio version 1.29 or higher, you can specify the system-defined axes group variable name for AT specification of a user-defined variable. This will allow you to specify the user-defined variable.

If you use Sysmac Studio version 1.28 or lower, do not specify any user-defined variable created in the variable table.

## Function

- While *Valid* (Enabled) is TRUE, the MC\_GroupReadPosition instruction gets the command current positions and the actual current positions of the composition axes in the axes group each control period.
- The following table lists the position types that can be used for each axis type.

Axis type	Types of positions	
	Command current position	Actual current position
Servo axis	Applicable	Applicable

Axis type	Types of positions	
	Command current position	Actual current position
Virtual servo axis	Applicable	Applicable*1
Encoder axis	Not applicable	Applicable
Virtual encoder axis	Not applicable	Applicable

\*1. For a virtual servo axis, the actual position is the same as the command position.

However, there is sometimes calculation error because processing is performed with long reals in the MC Function Module.

- You can execute this instruction even if home is not defined.
- You can execute this instruction regardless of whether the axes group is enabled or disabled.



### Precautions for Correct Use

Before you use this instruction in a task to which the axes group is not assigned, declare Axis Variables as external variables for the configuration axes that are specified in Axes (Axes Group Composition Axes) in the task.

## Timing Charts

- When *Enable* changes to TRUE, *Busy* (Executing) and *Valid* (Enabled) change to TRUE.
- When *Enable* changes to FALSE, *Busy* (Executing) and *Valid* (Enabled) change to FALSE.

### MC\_GroupReadPosition

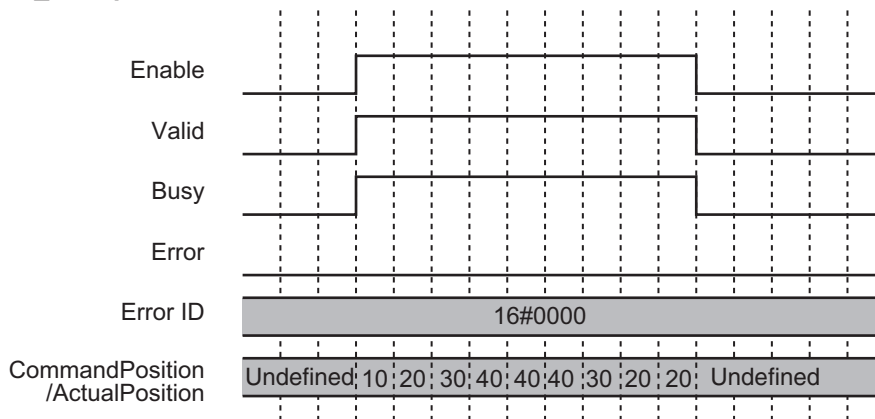

## Re-execution of Motion Control Instructions

You cannot re-execute motion instructions with enable-type inputs.

## Multi-execution of Motion Control Instructions

This instruction is executed independently from other instructions. The restrictions for multi-execution of motion instructions do not apply.

For details on multi-execution of motion control instructions, refer to the *NJ/NX-series CPU Unit Motion Control User's Manual (Cat. No. W507)*.

## Errors

If an error occurs during instruction execution, *Error* will change to TRUE.

You can find out the cause of the error by referring to the value output by *ErrorID* (Error Code).

### MC\_GroupReadPosition

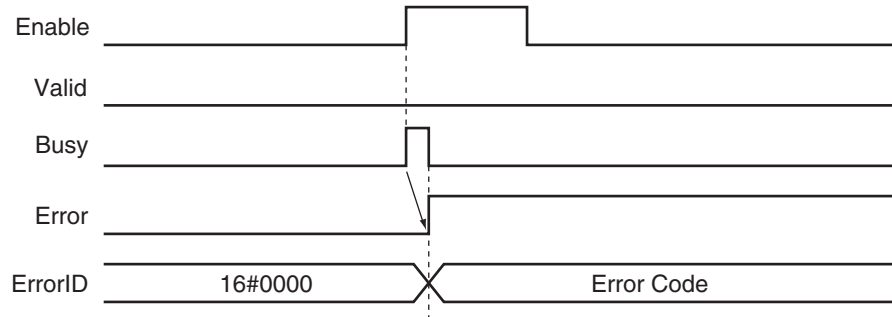

### ● Error Codes

Refer to the *NJ/NX-series Troubleshooting Manual (Cat. No. W503)* for instruction errors.

# MC\_ChangeAxesInGroup

The MC\_ChangeAxesInGroup instruction temporarily changes the **Composition Axes** axes group parameter.

Instruction	Name	FB/ FUN	Graphic expression	ST expression
MC_ChangeAxesInGroup	Change Axes in Group	FB		<pre>MC_ChangeAxesInGroup_instance (   AxesGroup :=parameter,   Axes :=parameter,   Execute :=parameter,   Done =&gt;parameter,   Busy =&gt;parameter,   CommandAborted =&gt;parameter,   Error =&gt;parameter,   ErrorID =&gt;parameter );</pre>



## Precautions for Correct Use

The values that are written by this instruction are not saved in non-volatile memory in the CPU Unit. Any values that are written are lost when the power supply to the Controller is turned OFF, when settings are downloaded, or when the MC Function Module is restarted. They return to the values that were set from the Sysmac Studio. Use the Sysmac Studio and transfer the parameters to save them to non-volatile memory.



## Additional Information

Use the Synchronize Menu of the Sysmac Studio to download the project.



## Version Information

A CPU Unit with unit version 1.01 or later and Sysmac Studio version 1.02 or higher are required to use this instruction.

## Variables

### Input Variables

Name	Meaning	Data type	Valid range	Default	Description
Execute	Execute	BOOL	TRUE or FALSE	FALSE	The instruction is executed when the value of this variable changes to TRUE.

### Output Variables

Name	Meaning	Data type	Valid range	Description
Done	Done	BOOL	TRUE or FALSE	TRUE when the instruction is completed.

Name	Meaning	Data type	Valid range	Description
Busy	Executing	BOOL	TRUE or FALSE	TRUE when the instruction is acknowledged.
CommandAborted	Command Aborted	BOOL	TRUE or FALSE	TRUE when the instruction is aborted.
Error	Error	BOOL	TRUE or FALSE	TRUE while there is an error.
ErrorID	Error Code	WORD	*1	Contains the error code when an error occurs. A value of 16#0000 indicates normal execution.

\*1. The upper four digits of the event code give the error code for ErrorID. Refer to the *NJ/NX-series Troubleshooting Manual (Cat. No. W503)* for the event codes.

### ● Output Variable Update Timing

Name	Timing for changing to TRUE	Timing for changing to FALSE
Done	When the instruction is completed.	<ul style="list-style-type: none"> <li>When <i>Execute</i> is TRUE and changes to FALSE.</li> <li>After one period when <i>Execute</i> is FALSE.</li> </ul>
Busy	When <i>Execute</i> changes to TRUE.	<ul style="list-style-type: none"> <li>When <i>Done</i> changes to TRUE.</li> <li>When <i>Error</i> changes to TRUE.</li> <li>When <i>CommandAborted</i> changes to TRUE.</li> </ul>
CommandAborted	When this instruction is canceled due to an error in another instruction.	<ul style="list-style-type: none"> <li>When <i>Execute</i> is TRUE and changes to FALSE.</li> <li>After one period when <i>Execute</i> is FALSE.</li> </ul>
Error	When there is an error in the execution conditions or input parameters for the instruction.	When the error is cleared.

## In-Out Variables

Name	Meaning	Data type	Valid range	Description
AxesGroup	Axes Group	_sGROUP_RE EF	---	Specify the axes group for which to change the axes. *1
Axes	Axes Group Composition Axes	ARRAY [0..3] OF UINT	---	Specify the axis numbers of the new composition axes. *2

\*1. Specify a user-defined Axes Group Variable that was created in the Axes Group Basic Settings of the Sysmac Studio (default: MC\_Group\*) or a system-defined axes group variable name (\_MC\_GRP[\*], \_MC1\_GRP[\*], or \_MC2\_GRP[\*]). If you use Sysmac Studio version 1.29 or higher, you can specify the system-defined axes group variable name for AT specification of a user-defined variable. This will allow you to specify the user-defined variable.

If you use Sysmac Studio version 1.28 or lower, do not specify any user-defined variable created in the variable table.

\*2. Set only servo axes or virtual servo axes as the composition axes. Specify the same number of composition axes as the number before the composition axes are changed.

## Function

- When *Execute* changes to TRUE, the MC\_ChangeAxesInGroup instruction writes the composition axes that are specified in *Axes* (Axes Group Composition Axes) to the *Axes Group* parameter for the axes group that is specified in *AxesGroup* (Axes Group).



- When execution of the instruction is completed, *Axis[ J ]* in the *Kinematics* (Kinematics Transformation Settings) axes group variable will indicate the specified composition axes.
- You cannot use this instruction to change the axis composition (i.e., the number of axes). For example, if you execute this instruction for an axes group with an axis composition of three axes, the axis composition will still contain three axes.
- The operation for changing the axes numbers of the composition axes from 0, 1, 2, and 3 to 7, 6, 5, and 4 is illustrated below.

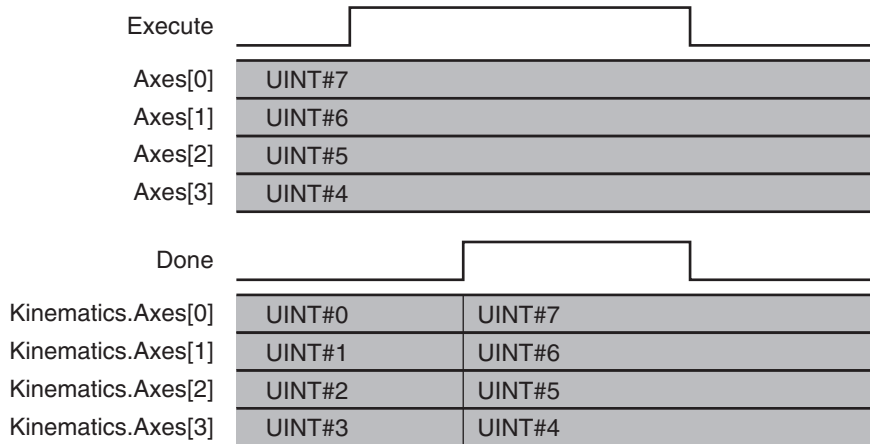

- You can execute this instruction regardless of whether home is defined.
- You can execute this instruction only when the axes group is disabled.



**Precautions for Correct Use**

- The values that are written by this instruction are not saved in non-volatile memory in the CPU Unit. Any values that are written are lost when the power supply to the Controller is turned OFF, when settings are downloaded, or when the MC Function Module is restarted. They return to the values that were set from the Sysmac Studio. Use the Sysmac Studio and transfer the parameters to save them to non-volatile memory.
- If you use an NX-series CPU Unit, you must assign all of the composition axes specified in Axes (Axes Group Composition Axes) to the same task as the Axes Group for which to execute the instruction. If you specify an axis that is assigned to a different task, an Axes Group Composition Axis Setting Out of Range error (error code 549D hex) occurs.

**Timing Charts**

- When *Execute* changes to TRUE, *Busy* (Executing) changes to TRUE.
- *Done* changes to TRUE when changing the composition axes is completed.

MC\_ChangeAxesInGroup Instruction

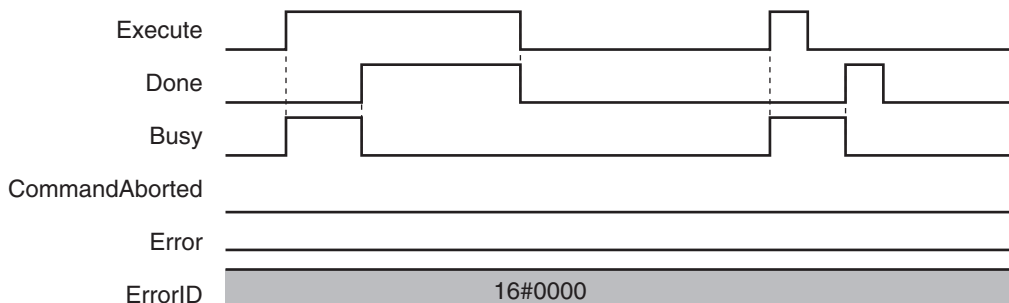

## Re-execution of Motion Control Instructions

This instruction cannot be re-executed.

A Motion Control Instruction Re-execution Disabled error (error code: 543B hex) occurs if re-execution is attempted.

## Multi-execution of Motion Control Instructions

For details on multi-execution of motion control instructions, refer to the *NJ/NX-series CPU Unit Motion Control User's Manual (Cat. No. W507)*.

## Errors

If an error occurs during instruction execution, *Error* will change to TRUE and parameters are not written. The values before the instruction was executed will be held.

You can find out the cause of the error by referring to the value output by *ErrorID* (Error Code).

### ● Timing Chart When Error Occurs

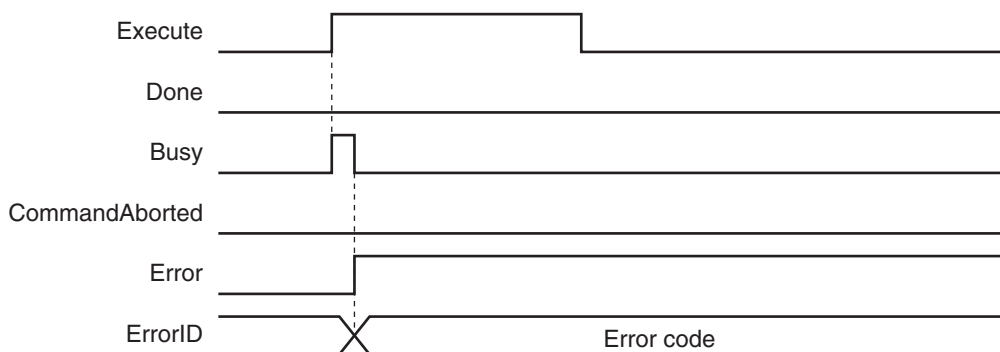

### ● Error Codes

Refer to the *NJ/NX-series Troubleshooting Manual (Cat. No. W503)* for instruction errors.

# MC\_GroupSyncMoveAbsolute

The MC\_GroupSyncMoveAbsolute instruction cyclically outputs the specified target positions for the axes.

Instruction	Name	FB/ FUN	Graphic expression	ST expression
MC_GroupSyncMoveAbsolute	Axes Group Cyclic Synchronous Absolute Positioning	FB		<pre>MC_GroupSyncMoveAbsolute_instance (   AxesGroup :=parameter,   Execute :=parameter,   Position :=parameter,   CoordSystem :=parameter,   BufferMode :=parameter,   InPosition =&gt;parameter,   Busy =&gt;parameter,   Active =&gt;parameter,   CommandAborted =&gt;parameter,   Error =&gt;parameter,   ErrorID =&gt;parameter );</pre>



## Version Information

A CPU Unit with unit version 1.01 or later and Sysmac Studio version 1.02 or higher are required to use this instruction.

## Variables

### Input Variables

Name	Meaning	Data type	Valid range	Default	Description
Execute	Execute	BOOL	TRUE or FALSE	FALSE	The instruction is executed when the value of this variable changes to TRUE.
Position	Target Position	ARRAY [0..3] OF LREAL	Negative number, positive number, or 0	0	Specify the absolute target positions. The unit is command units. *1
CoordSystem	Coordinate System	_eMC_COORD_SYSTEM	0: _mcACS	0*2	Specify the coordinate system. 0: Axis coordinate system (ACS)
BufferMode	Buffer Mode Selection	_eMC_BUFFER_MODE	0: _mcAborting	0*2	Specify the behavior when executing more than one motion instruction. 0: Aborting

\*1. Refer to *Unit Conversion Settings* in the *NJ/NX-series CPU Unit Motion Control User's Manual (Cat. No. W507)* for information on command units.

\*2. The default value for an enumeration variable is actually not the number, but the enumerator.

## Output Variables

Name	Meaning	Data type	Valid range	Description
InPosition	In Position	BOOL	TRUE or FALSE	TRUE when the actual current positions for all composition axes are within the in-position range of their target positions.
Busy	Executing	BOOL	TRUE or FALSE	TRUE when the instruction is acknowledged.
Active	Controlling	BOOL	TRUE or FALSE	TRUE when the axis is being controlled.
CommandAborted	Instruction Aborted	BOOL	TRUE or FALSE	TRUE when the instruction is aborted.
Error	Error	BOOL	TRUE or FALSE	TRUE while there is an error.
ErrorID	Error Code	WORD	*1	Contains the error code when an error occurs. A value of 16#0000 indicates normal execution.

\*1. The upper four digits of the event code give the error code for ErrorID. Refer to the *NJ/NX-series Troubleshooting Manual (Cat. No. W503)* for the event codes.

### ● Output Variable Update Timing

Name	Timing for changing to TRUE	Timing for changing to FALSE
InPosition	When the actual current positions for all composition axes are within the in-position range of their target positions.	<ul style="list-style-type: none"> <li>When an actual current position is outside of the in-position range.</li> <li>When <i>Error</i> changes to TRUE.</li> <li>When <i>CommandAborted</i> changes to TRUE.</li> </ul>
Busy	When <i>Execute</i> changes to TRUE.	<ul style="list-style-type: none"> <li>When <i>Error</i> changes to TRUE.</li> <li>When <i>CommandAborted</i> changes to TRUE.</li> </ul>
Active	When the instruction is started.	<ul style="list-style-type: none"> <li>When <i>Error</i> changes to TRUE.</li> <li>When <i>CommandAborted</i> changes to TRUE.</li> </ul>
CommandAborted	<ul style="list-style-type: none"> <li>When this instruction is aborted because another motion control instruction was executed with the Buffer Mode set to Aborting.</li> <li>When this instruction is canceled due to an error in another instruction.</li> <li>When this instruction is executed while there is an axis error.</li> <li>When you start this instruction during <i>MC_GroupStop</i> instruction execution.</li> </ul>	<ul style="list-style-type: none"> <li>When <i>Execute</i> is TRUE and changes to FALSE.</li> <li>After one period when <i>Execute</i> is FALSE.</li> </ul>
Error	When there is an error in the execution conditions or input parameters for the instruction.	When the error is cleared.

## In-Out Variables

Name	Meaning	Data type	Valid range	Description
AxesGroup	Axes Group	_sGROUP_RE EF	---	Specify the axes group. *1

\*1. Specify a user-defined Axes Group Variable that was created in the Axes Group Basic Settings of the Sysmac Studio (default: *MC\_Group\**) or a system-defined axes group variable name (*\_MC\_GRP\**, *\_MC1\_GRP\**, or *\_MC2\_GRP\**).

If you use Sysmac Studio version 1.29 or higher, you can specify the system-defined axes group variable name for AT specification of a user-defined variable. This will allow you to specify the user-defined variable.

If you use Sysmac Studio version 1.28 or lower, do not specify any user-defined variable created in the variable table.

## Function

- The MC\_GroupSyncMoveAbsolute instruction outputs the target position from the user program every task period to the Servo Drive or other device in Cyclic Synchronous Position (CSP) Control Mode. The target positions are given as absolute positions.
- The upper limit of the velocity is the value that is set in the **Maximum Velocity** axis parameter. The **Maximum Acceleration** and **Maximum Deceleration** are not used.
- If this instruction is executed in the primary periodic task or priority-5 periodic task, the target position that is specified in the input parameters is output to the Servo Drive in the next task period. The following timing charts show an example of the operation for when this instruction is executed in the primary periodic task.

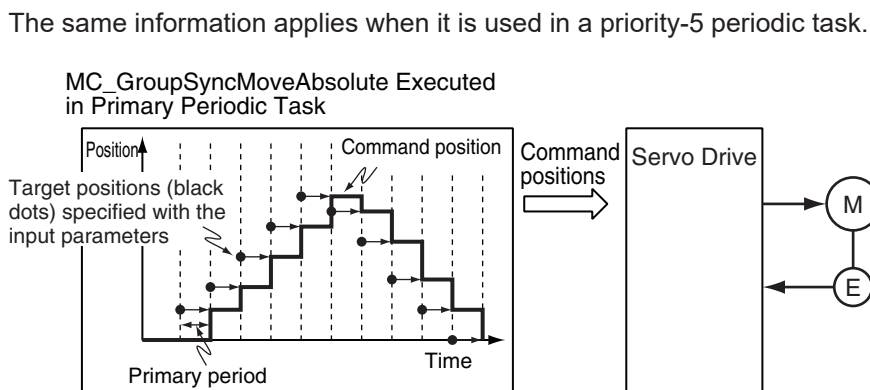

- If this instruction is executed in the priority-16 periodic task, the target positions that are specified in the input parameters are output to the Servo Drive in the next periodic task.

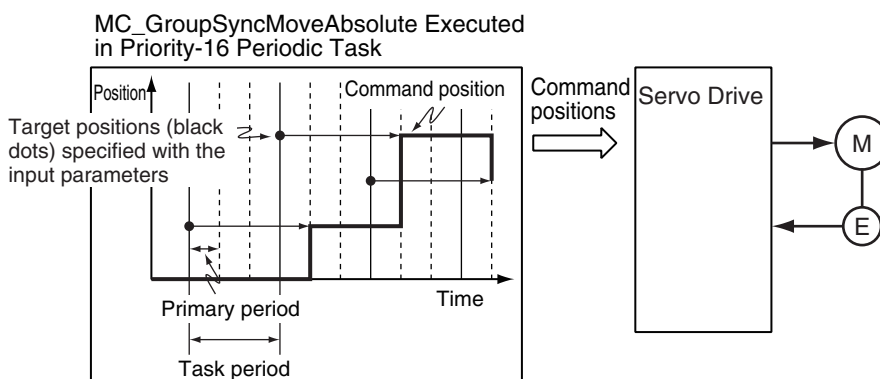



### Precautions for Correct Use

- An Instruction Execution Error with Undefined Home (error code: 5466 hex) occurs if home is undefined for any of the composition axes in the axes group.
- Specify the target positions so that the travel distances to the target positions do not cause the velocity to exceed the value that is specified in the **Maximum Velocity** axis parameter. If target positions are specified that cause the **Maximum Velocity** to be exceeded, the command velocity will become saturated and the travel distances will be output so that the **Maximum Velocity** is not exceeded. If this occurs, any insufficient travel distances to the target positions are output in the next period or later.  
*Details.* *VelLimit* (Command Velocity Saturation) in the axis control status changes to TRUE at this time.

## Instruction Details

This section describes the instruction in detail.

### ● In-position Check

If *Position* (Target Position) is not changed, *InPosition* changes to TRUE when the difference between the target position and the actual position is within the range that is set for the **In-position Range** axis parameter.

Even if the target position is changed while *InPosition* is TRUE, it will remain TRUE for the remainder of the period and change to FALSE the next period.

The setting of the **In-position Check Time** axis parameter is disabled.

### ● Stop Processing

This section describes the methods that are used to stop axes group operations.

Use the *MC\_GroupStop* instruction or the *MC\_GroupImmediateStop* instruction to stop axes group operation. If one of these instructions is executed, *CommandAborted* for this instruction will change to TRUE.

#### Stopping with the *MC\_GroupStop* Instruction

An immediate stop is performed.

#### Stopping with the *MC\_GroupImmediateStop* Instruction

An immediate stop is performed according to the setting of the **Immediate Stop Input Stop Method** axis parameter for each axis.

### ● Stopping Due to Errors

If an error that causes the axes to stop occurs, an immediate stop is performed regardless of any settings.

### ● Applicable Axes

- You can use this instruction for a servo axis.  
To use this instruction, change *Enable* for the *MC\_Power* instruction to TRUE (Servo ON).
- A virtual servo axis will acknowledge this instruction at any time.

### ● Start Condition

- Set the **Count Mode** axis parameters to **Linear Mode**.
- Define home for all of the composition axes.
- Execute the MC\_GroupEnable instruction to enable the axes group.

### ● Axis Variable Status

*Status.Moving* in the Axes Group Variable is TRUE during axes group motion.  
The Axes Group Control Status is not affected.

### ● Overrides

Overrides are disabled for this instruction.

## Timing Charts

- *Busy* (Executing) changes to TRUE at the same time as *Execute* changes to TRUE. *Active* (Controlling) changes to TRUE in the next period.
- *InPosition* changes to TRUE when the actual current positions for all composition axes are within the in-position range from *Position* (Target Positions).
- If another instruction aborts this instruction, *CommandAborted* changes to TRUE and *Busy* (Executing), *Active* (Controlling), and *InPosition* change to FALSE.
- The MC\_GroupStop instruction is used to stop this instruction.

The following timing charts show operation for when this instruction is executed in the primary periodic task.

MC\_GroupSyncMoveAbsolute Instruction

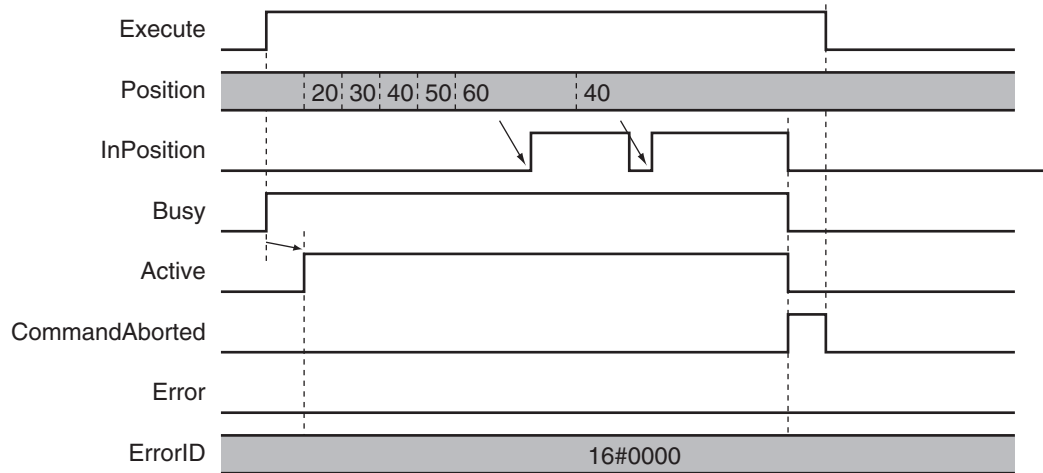

MC\_GroupStop Instruction

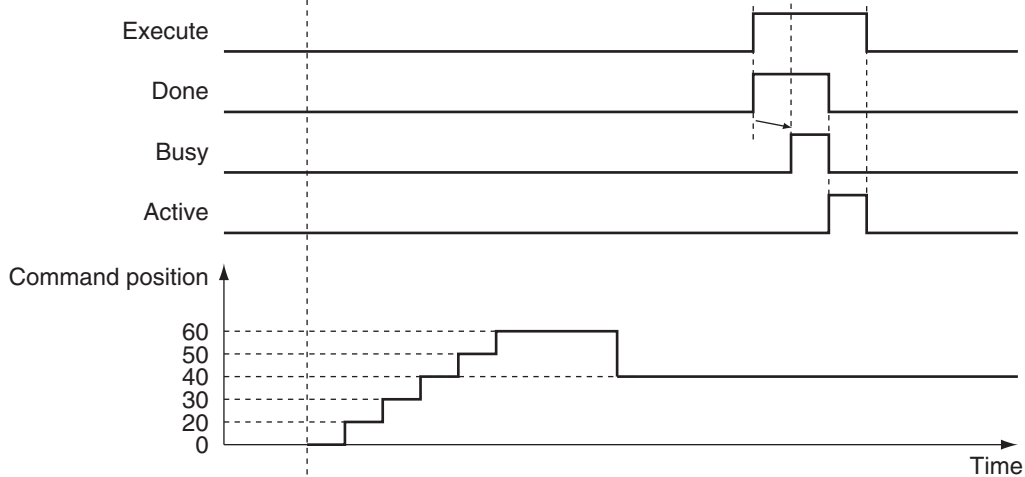

**Additional Information**

The MC Function Module sends a command to the Servo Drive to change the Control Mode as shown in the above timing chart. The timing of implementing the change in the Servo Drive depends on Servo Drive specifications.

**Re-execution of Motion Control Instructions**

This instruction cannot be re-executed.

A Motion Control Instruction Re-execution Disabled error (error code: 543B hex) occurs if re-execution is attempted.

**Multi-execution of Motion Control Instructions**

For details on multi-execution of motion control instructions, refer to the *NJ/NX-series CPU Unit Motion Control User's Manual (Cat. No. W507)*.



- **Execution during Execution of Other Instructions**

*BufferMode* can be set only to **Aborting** for this instruction.

- **Execution of Other Instructions during Instruction Execution**

If you execute another instruction during execution of this instruction, you can specify only **Aborting**.

## Errors

If an error occurs during instruction execution, *Error* will change to TRUE.

You can find out the cause of the error by referring to the value output by *ErrorID* (Error Code).

- **Timing Chart When Error Occurs**

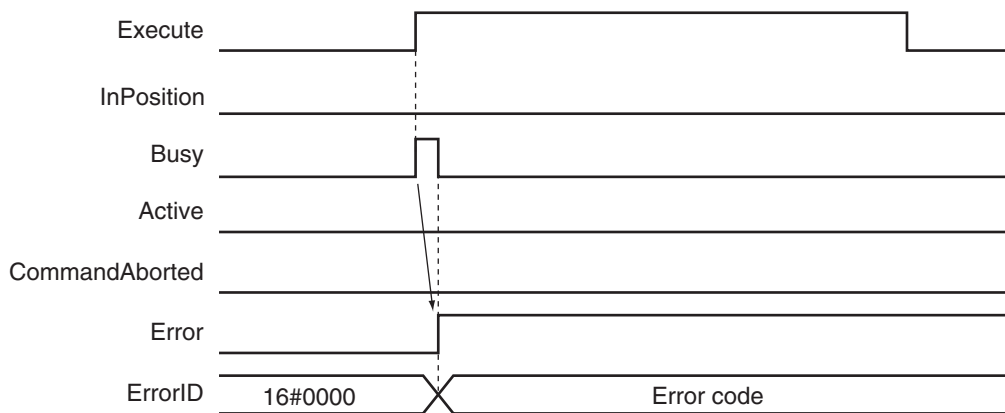

- **Error Codes**

Refer to the *NJ/NX-series Troubleshooting Manual (Cat. No. W503)* for instruction errors.

# MC\_GroupReset

The MC\_GroupReset instruction clears axes group errors and axis errors.

Instruction	Name	FB/ FUN	Graphic expression	ST expression
MC_GroupReset	Group Reset	FB		<pre>MC_GroupReset_instance (   AxesGroup :=parameter,   Execute :=parameter,   Done =&gt;parameter,   Busy =&gt;parameter,   Failure =&gt;parameter,   Error =&gt;parameter,   ErrorID =&gt;parameter );</pre>

## Variables

### Input Variables

Name	Meaning	Data type	Valid range	Default	Description
Execute	Execute	BOOL	TRUE or FALSE	FALSE	The instruction is executed when the value of this variable changes to TRUE.

### Output Variables

Name	Meaning	Data type	Valid range	Description
Done	Done	BOOL	TRUE or FALSE	TRUE when the instruction is completed.
Busy	Executing	BOOL	TRUE or FALSE	TRUE when the instruction is acknowledged.
Failure	Failure End	BOOL	TRUE or FALSE	TRUE when the instruction is not executed normally.
Error	Error	BOOL	TRUE or FALSE	TRUE while there is an error.
ErrorID	Error Code	WORD	*1	Contains the error code when an error occurs. A value of 16#0000 indicates normal execution.

\*1. The upper four digits of the event code give the error code for ErrorID. Refer to the *NJ/NX-series Troubleshooting Manual (Cat. No. W503)* for the event codes.

### ● Output Variable Update Timing

Name	Timing for changing to TRUE	Timing for changing to FALSE
Done	When error clear processing is completed normally.	<ul style="list-style-type: none"> <li>When <i>Execute</i> is TRUE and changes to FALSE.</li> <li>After one period when <i>Execute</i> is FALSE.</li> </ul>

Name	Timing for changing to TRUE	Timing for changing to FALSE
Busy	When <i>Execute</i> changes to TRUE.	<ul style="list-style-type: none"> <li>When <i>Done</i> changes to TRUE.</li> <li>When <i>Error</i> changes to TRUE.</li> <li>When <i>Failure</i> changes to TRUE.</li> </ul>
Failure	<ul style="list-style-type: none"> <li>When an instruction is executed while an axis or axes group is decelerating to a stop caused by an error.</li> <li>When an instruction is executed while there is an axes group error that is caused by an axis common error.</li> </ul>	<ul style="list-style-type: none"> <li>When <i>Execute</i> is TRUE and changes to FALSE.</li> <li>After one period when <i>Execute</i> is FALSE.</li> </ul>
Error	When there is an error in the execution conditions or input parameters for the instruction.	When the error is cleared.

## In-Out Variables

Name	Meaning	Data type	Valid range	Description
AxesGroup	Axes Group	_sGROUP_RE EF	---	Specify the axes group. *1

- \*1. Specify a user-defined Axes Group Variable that was created in the Axes Group Basic Settings of the Sysmac Studio (default: MC\_Group\*) or a system-defined axes group variable name (\_MC\_GRP[\*], \_MC1\_GRP[\*], or \_MC2\_GRP[\*]). If you use Sysmac Studio version 1.29 or higher, you can specify the system-defined axes group variable name for AT specification of a user-defined variable. This will allow you to specify the user-defined variable. If you use Sysmac Studio version 1.28 or lower, do not specify any user-defined variable created in the variable table.

## Function

- When *Execute* changes to TRUE, the error of the axes group specified by *AxesGroup* in the *GroupEnable* state and axis errors of axes belonging to the axes group are cleared. The following are reset: minor faults or observations that occur for axes or axes groups and drive errors.
- Error clear processing is performed regardless of whether the Servo is ON or OFF for the axes.
- If there is a drive error for an axis, the drive error is cleared first. Error clear processing is then performed.
- Reset processing for the drive error is continued until the drive error is cleared or continues for the **Drive Error Reset Monitoring Time** in the axis parameters. The drive error reset process is executed for all axes belonging to the axes group at the same time.
- Only errors that existed when *Execute* changed to TRUE are reset. Errors that occur while clearing errors are not cleared.
- If this instruction is executed while the axes group is decelerating to a stop for an axes group error and the instruction is not executed, *Failure* will change to TRUE. This is so that the error cannot be reset before the axis stops. *Failure* will also change to TRUE if an axis error that results from an axis common error cannot be cleared by this instruction.



### Precautions for Correct Use

- The error clear processing that is performed by this instruction sometimes requires more than one control period.
- The *Failure* output variable from the instruction will change to TRUE if the axis is in motion. Remove the cause of the error, and then retry the process until *Done* changes to TRUE.
- After you remove the cause of the error, execute the instruction only after you confirm that the axes have stopped completely.
- If you use this instruction for an OMRON G5-series Servo Drive, perform exclusive control of instructions so that the ResetECError (Reset EtherCAT Error) instruction is not executed at the same time.
- If this instruction is used for an NX-series Pulse Output Unit, the error in the Servo Drive that is connected to the Pulse Output Unit is not reset. Refer to the *NX-series Position Interface Units User's Manual (Cat. No. W524)* for details.



### Additional Information

- You can clear axis errors only when the axes group is enabled.
- The following errors cannot be cleared with this instruction.  
All axis common errors  
To clear axis common errors, execute the ResetMcError (Reset All Errors) instruction separately.
- If you execute this instruction on an axes group for which there is no error, the instruction is completed normally and the current status is continued.

## Timing Charts

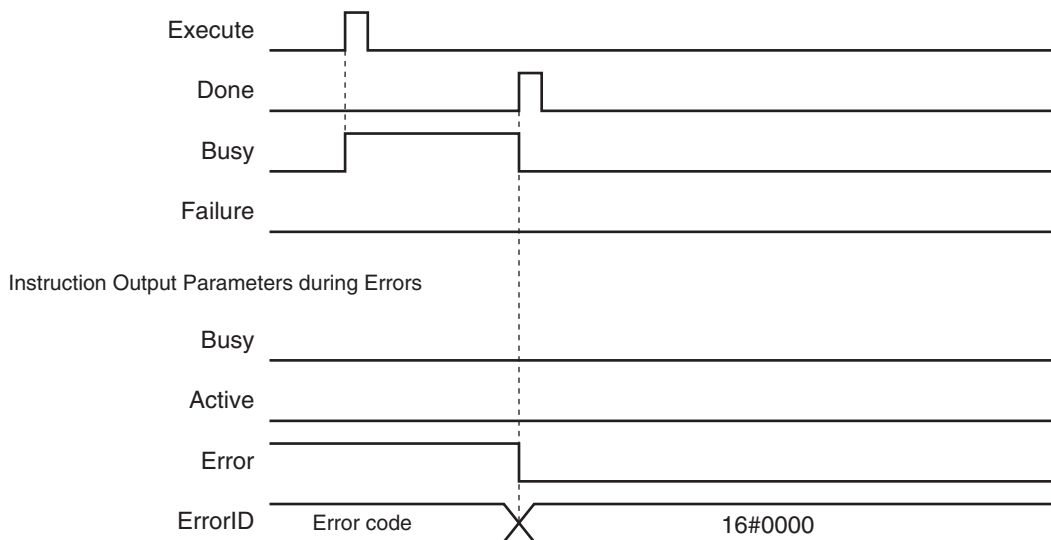

## Aborting the Instruction

The instruction is aborted if it is not possible to clear errors that occur when the axis or axes group is decelerating to a stop for an error or errors that occur during axes group errors resulting from axis common errors.

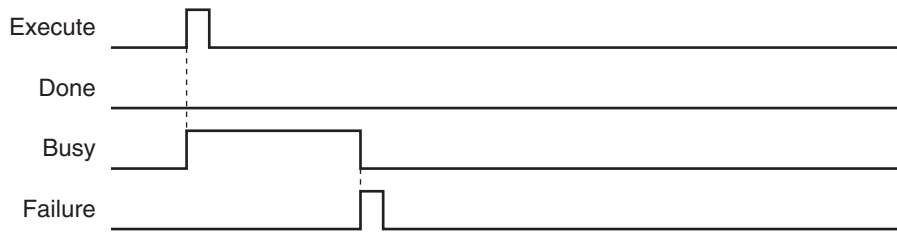

## Re-execution of Motion Control Instructions

If the instruction is re-executed by changing *Execute* to TRUE again, the re-executed instruction is ignored and error clear processing is continued.

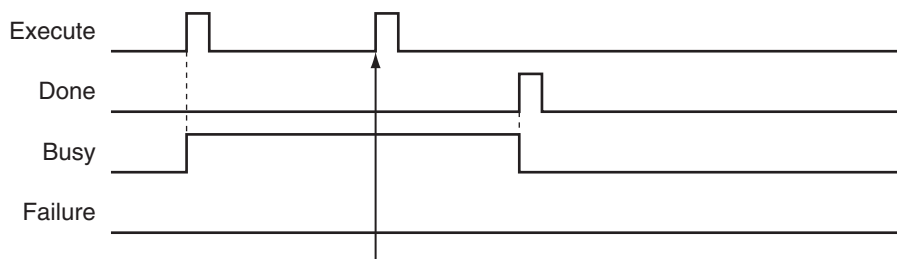

The command from re-executing the instruction is not acknowledged and the current processing is continued.

## Multi-execution of Motion Control Instructions

For details on multi-execution of motion control instructions, refer to the *NJ/NX-series CPU Unit Motion Control User's Manual (Cat. No. W507)*.

### ● Execution of Other Instructions during Instruction Execution

If another instance of the MC\_GroupReset instruction is executed for the same axes group, both instructions are executed.

If a slave error occurs, processing may wait until the **Drive Error Reset Monitoring Time** that is set for the axis expires. The elapsed time is counted for each instruction instance.

If MC\_Reset (Reset Axis Error) is executed for the axes belonging to the specified axes group while this instruction is in execution, both instructions are executed.

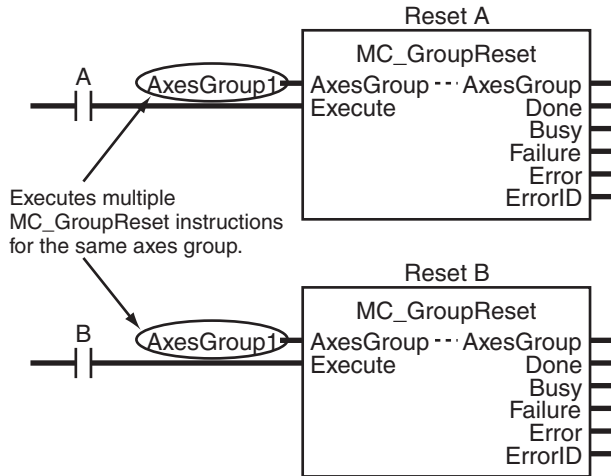

## Error Codes

Refer to the *NJ/NX-series Troubleshooting Manual (Cat. No. W503)* for instruction errors.

# 5

## Common Command Instructions

This section describes the instructions that are used for both axes and axes groups.

---

<b>MC_SetCamTableProperty</b> .....	<b>5-2</b>
<b>MC_SaveCamTable</b> .....	<b>5-8</b>
<b>MC_Write</b> .....	<b>5-13</b>
<b>MC_GenerateCamTable</b> .....	<b>5-19</b>
<b>MC_WriteAxisParameter</b> .....	<b>5-49</b>
<b>MC_ReadAxisParameter</b> .....	<b>5-64</b>

# MC\_SetCamTableProperty

The MC\_SetCamTableProperty instruction changes the end point index of the cam table that is specified in an in-out parameter.

Instruction	Name	FB/ FUN	Graphic expression	ST expression
MC_SetCamTableProperty	Set Cam Table Properties	FB		<pre>MC_SetCamTableProperty_instance (   CamTable :=parameter,   Execute :=parameter,   Done =&gt;parameter,   EndPointIndex =&gt;parameter,   MaxDataNumber =&gt;parameter,   Busy =&gt;parameter,   CommandAborted =&gt;parameter,   Error =&gt;parameter,   ErrorID =&gt;parameter );</pre>

## Variables

### Input Variables

Name	Meaning	Data type	Valid range	Default	Description
Execute	Execute	BOOL	TRUE or FALSE	FALSE	The instruction is executed when the value of this variable changes to TRUE.

### Output Variables

Name	Meaning	Data type	Valid range	Description
Done	Done	BOOL	TRUE or FALSE	TRUE when the instruction is completed.
EndPointIndex	End Point Index	UINT	Non-negative number	Contains the cam table end point index.
MaxDataNumber	Maximum Number of Cam Data	UINT	Positive number	Contains the maximum number of cam data.
Busy	Executing	BOOL	TRUE or FALSE	TRUE when the instruction is acknowledged.
CommandAborted	Command Aborted	BOOL	TRUE or FALSE	TRUE when the instruction is aborted.
Error	Error	BOOL	TRUE or FALSE	TRUE while there is an error.



Name	Meaning	Data type	Valid range	Description
ErrorID	Error Code	WORD	*1	Contains the error code when an error occurs. A value of 16#0000 indicates normal execution.

\*1. The upper four digits of the event code give the error code for ErrorID. Refer to the *NJ/NX-series Troubleshooting Manual (Cat. No. W503)* for the event codes.

### ● Output Variable Update Timing

Name	Timing for changing to TRUE	Timing for changing to FALSE
Done	When overwriting cam table data is completed.	<ul style="list-style-type: none"> <li>When <i>Execute</i> is TRUE and changes to FALSE.</li> <li>After one period when <i>Execute</i> is FALSE.</li> </ul>
Busy	When <i>Execute</i> changes to TRUE.	<ul style="list-style-type: none"> <li>When <i>Done</i> changes to TRUE.</li> <li>When <i>Error</i> changes to TRUE.</li> <li>When <i>CommandAborted</i> changes to TRUE.</li> </ul>
CommandAborted	When there is a reason to abort this instruction.	<ul style="list-style-type: none"> <li>When <i>Execute</i> is TRUE and changes to FALSE.</li> <li>After one period when <i>Execute</i> is FALSE.</li> </ul>
Error	When there is an error in the execution conditions or input parameters for the instruction.	When the error is cleared.

## In-Out Variables

Name	Meaning	Data type	Valid range	Description
CamTable	Cam Table	ARRAY[0..N] OF _sMC_CAM_REF	---	Specify the cam data structure <code>_sMC_CAM_REF</code> array variable as the cam table. *1

\*1. *N* in the array variable is set automatically by the Sysmac Studio. Specify a cam data variable that was created on Cam Editor of the Sysmac Studio.

## Function

- The `MC_SetCamTableProperty` instruction changes the end point index of the cam table that is specified in an in-out parameter.
- The end point is the data located one cam data before the first cam data with a phase of 0 after the start point in the cam table.
- The array number of the end point is output to *EndPointIndex*.
- Any data that is detected after the 0 phase is detected is treated as invalid cam data, and the phase/displacement values are ignored.
- The maximum number of cam data represents the maximum number of elements in an array of cam data structures.  
The maximum number of cam data is specified when the structure array is declared with the Sysmac Studio.
- When the user program changes the cam data end point index, the end point must be updated. Use this instruction to update the number of valid cam data.

For details on cam tables, refer to the *NJ/NX-series CPU Unit Motion Control User's Manual (Cat. No. W507)*.



### Precautions for Correct Use

- When searching the cam table, an error will occur if the phases are not in ascending order before the 0 phase is found.
- You cannot change the maximum number of cam data from the user program.
- Execute this instruction after changing the end point in the cam data or overwriting values in the cam data.  
If the end point index is changed or the phases are not in ascending order, the cam operation and the operation of the *EndOfProfile* (End of Cam Cycle) of the MC\_CamIn (Start Cam Operation) instruction may not be as expected.
- If the cam table is changed while this instruction is being processed, the update process will not be performed correctly. Wait for execution of this instruction to be completed before you change the cam data from the user program.
- Cam data variables are global variables. You can therefore access or change the values of cam data variables from more than one task. If you change the values of cam data variables from more than one task, program the changes so that there is no competition in writing the value from more than one task.
- If you use exclusive control of global variables between tasks for a cam data variable, do not use the cam data variable for motion control instructions while exclusive control is in effect for the cam data variable. An Incorrect Cam Table Specification error (error code: 5439 hex) will occur.

## Instruction Details

For example, refer to the following cam table. The *EndPointIndex* is 999 and the *MaxDataNumber* (Maximum Number of Cam Data) is 5,000.

Cam data structure array	Phase	Displacement	
MyCam1 [0]	0	0	Start point
.	.	.	
.	.	.	
.	.	.	
MyCam1 [997]	359.8	2	Valid data
MyCam1 [998]	359.9	1	
MyCam1 [999]	360.0	0	
MyCam1 [1000]	0	0	End point
.	.	.	
.	.	.	Invalid data
.	.	.	
.	.	.	
MyCam1 [4999]	0	0	Maximum number of data: 5,000

The following tables show the relationship between overwriting of the cam data and the *EndPointIndex*.

If this instruction is executed with a cam table in which the phases for MyCam1[1000] on are 0, *EndPointIndex* will be 999.

If this instruction is executed for a cam table after the phase for MyCam1[997] is changed to 0, *EndPointIndex* will be 996.

Cam data structure array	Phase	Displacement	Phase	Displacement	
MyCam1 [0]	0	0	0	0	
.	.	.	.	.	
.	.	.	.	.	
.	.	.	.	.	
MyCam1 [995]	359.6	5	359.6	5	
MyCam1 [996]	359.7	4	360.0	0	End point
MyCam1 [997]	359.8	2	0	0	Invalid data
MyCam1 [998]	359.9	1	359.9	1	
MyCam1 [999]	360.0	0	360.0	0	
MyCam1 [1000]	0	0	0	0	
.	.	.	.	.	
.	.	.	.	.	
.	.	.	.	.	
MyCam1 [4999]	0	0	0	0	

If this instruction is executed for a cam table after the phases for MyCam1[1000] to MyCam1[4997] are changed to anything other than 0, *EndPointIndex* will be 4997.

Cam data structure array	Phase	Displacement	Phase	Displacement	
MyCam1 [0]	0	0	0	0	
.	.	.	.	.	
.	.	.	.	.	
.	.	.	.	.	
MyCam1 [998]	359.9	1	100.3	20.3	
MyCam1 [999]	360.0	0	100.4	20.4	End point
MyCam1 [1000]	0	0	100.5	20.5	Invalid data
.	.	.	.	.	
.	.	.	.	.	
.	.	.	.	.	
MyCam1 [4996]	0	0	359.99	0.01	
MyCam1 [4997]	0	0	360.00	0.0	End point
MyCam1 [4998]	0	0	0	0	Invalid data
MyCam1 [4999]	0	0	0	0	

If this instruction is not executed even though the phases for MyCam1[1000] to MyCam1[4997] were overwritten to values other than 0, cam operation will be executed between MyCam1[0] to MyCam1[999].

The cam table is overwritten, but the *EndPointIndex* does not change.

For information on the cam table data structure, refer to *MC\_CamIn* on page 3-173.

## Timing Charts

The following chart shows two ways to execute the instruction. A normal end is indicated for either method.

The first time, *Execute* is changed to TRUE and then it is changed to FALSE before execution of the instruction is completed.

The second time, the value of *Execute* is held.

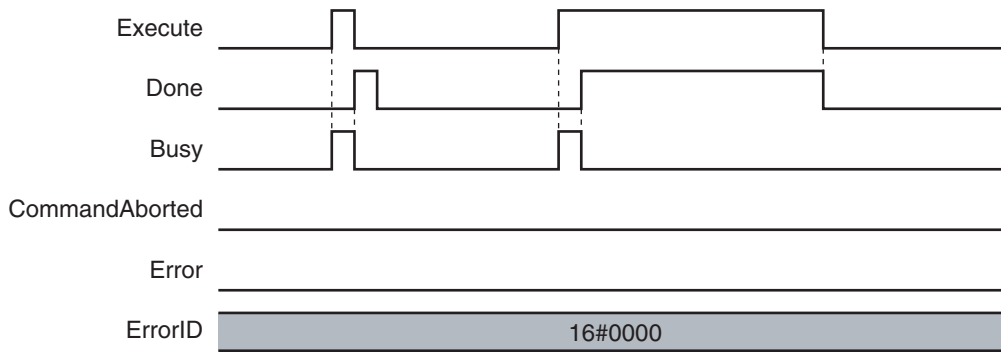

## Re-execution of Motion Control Instructions

This instruction cannot be re-executed.

A Motion Control Instruction Re-execution Disabled error (error code: 543B hex) occurs if re-execution is attempted.

## Multi-execution of Motion Control Instructions

### ● Execution during Execution of Other Instructions

Multi-execution of instructions cannot be used for this instruction if the cam table specified by *CamTable* is used by another instruction such as *MC\_SaveCamTable*, *MC\_SetCamTableProperty*, or *MC\_GenerateCamTable*.

### ● Execution of Other Instructions during Instruction Execution

Multi-execution of instructions cannot be used for other instructions such as *MC\_SaveCamTable*, *MC\_SetCamTableProperty*, or *MC\_GenerateCamTable* if the same cam table is specified with *CamTable* for this instruction.

## Errors

If an error occurs during instruction execution, *Error* will change to TRUE.

You can find out the cause of the error by referring to the value output by *ErrorID* (Error Code).

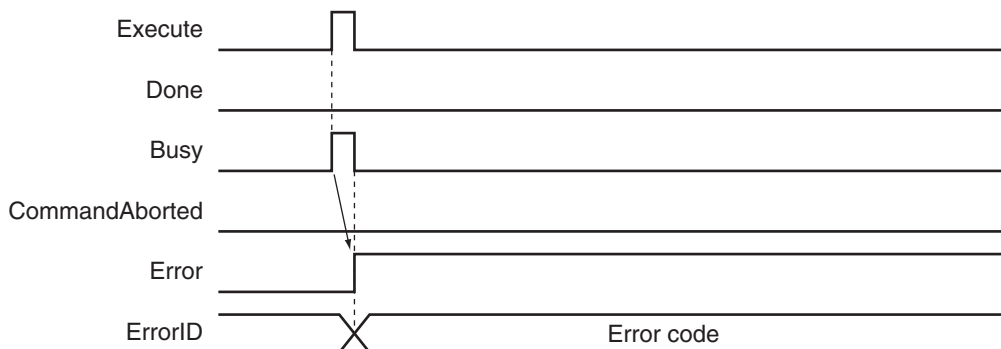

- **Error Codes**

Refer to the *NJ/NX-series Troubleshooting Manual (Cat. No. W503)* for instruction errors.

# MC\_SaveCamTable

The MC\_SaveCamTable instruction saves the cam table specified with the input parameter to non-volatile memory.

Instruction	Name	FB/ FUN	Graphic expression	ST expression
MC_SaveCamTable	Save Cam Table	FB		<pre>MC_SaveCamTable_instance (   CamTable :=parameter,   Execute :=parameter,   Done =&gt;parameter,   Busy =&gt;parameter,   CommandAborted =&gt;parameter,   Error =&gt;parameter,   ErrorID =&gt;parameter );</pre>

## Variables

### Input Variables

Name	Meaning	Data type	Valid range	Default	Description
Execute	Execute	BOOL	TRUE or FALSE	FALSE	The instruction is executed when the value of this variable changes to TRUE.

### Output Variables

Name	Meaning	Data type	Valid range	Description
Done	Done	BOOL	TRUE or FALSE	TRUE when the instruction is completed.
Busy	Executing	BOOL	TRUE or FALSE	TRUE when the instruction is acknowledged.
CommandAborted	Command Aborted	BOOL	TRUE or FALSE	TRUE when the instruction is aborted.
Error	Error	BOOL	TRUE or FALSE	TRUE while there is an error.
ErrorID	Error Code	WORD	*1	Contains the error code when an error occurs. A value of 16#0000 indicates normal execution.

\*1. The upper four digits of the event code give the error code for ErrorID. Refer to the *NJ/NX-series Troubleshooting Manual (Cat. No. W503)* for the event codes.

### ● Output Variable Update Timing

Name	Timing for changing to TRUE	Timing for changing to FALSE
Done	When saving cam table data is completed.	<ul style="list-style-type: none"> <li>When <i>Execute</i> is TRUE and changes to FALSE.</li> <li>After one period when <i>Execute</i> is FALSE.</li> </ul>

Name	Timing for changing to TRUE	Timing for changing to FALSE
Busy	When <i>Execute</i> changes to TRUE.	<ul style="list-style-type: none"> <li>When <i>Done</i> changes to TRUE.</li> <li>When <i>Error</i> changes to TRUE.</li> <li>When <i>CommandAborted</i> changes to TRUE.</li> </ul>
CommandAborted	When there is a reason to abort this instruction.	<ul style="list-style-type: none"> <li>When <i>Execute</i> is TRUE and changes to FALSE.</li> <li>After one period when <i>Execute</i> is FALSE.</li> </ul>
Error	When there is an error in the execution conditions or input parameters for the instruction.	When the error is cleared.

## In-Out Variables

Name	Meaning	Data type	Valid range	Description
CamTable	Cam Table	ARRAY[0..N] OF _sMC_CAM_REF	---	Specify the cam data structure _sMC_CAM_REF array variable as the cam table. *1

\*1. *N* in the array variable is set automatically by the Sysmac Studio. Specify a cam data variable that was created on Cam Editor of the Sysmac Studio.

## Function

- The MC\_SaveCamTable instruction saves the cam table specified with the in-out variable to non-volatile memory.
- \_MC\_COM.Status.CamTableBusy (Cam Table File Save Busy) in the system-defined variables for motion control is TRUE while the cam table is saved.

For information on the cam table data, refer to *MC\_CamIn* on page 3-173.



### Precautions for Correct Use

---

- Use this instruction to save the cam data after it is overwritten before you turn OFF the Controller. If you turn OFF the Controller without saving the data, the overwritten data will be lost.
  - If the cam table is changed while this instruction is being processed, the update process will not be performed correctly. Do not write to the cam table while this instruction is being processed when changing the cam table from the user program.
  - This instruction has a considerably longer processing time compared with other instructions. The processing time is greatly affected by the processing load on the CPU Unit. If the next instruction is executed taking the completion of this instruction as a trigger, take care with the timing of execution of the next instruction.
  - Do not turn OFF the Controller while this instruction is being processed. The data is not saved correctly if the Controller is turned OFF. The cam data in non-volatile memory may become corrupted.
  - If the power supply to the Controller is turned OFF while this instruction is being processed, a major fault level error may occur when the power supply is turned ON next time.
  - You cannot upload cam data, download cam data, start online operation, perform online editing, or start data traces during execution of this instruction.  
If this instruction is executed during a cam data upload, cam data download, or online editing, a Cannot Execute Save Cam Table Instruction error (error code: 743C hex) occurs. Perform retry processing until the cam data is saved normally.  
Use the Synchronize Menu of the Sysmac Studio to upload and download the data.
  - There is a limit to the number of times that you can write non-volatile memory. The life of the non-volatile memory will expire faster if this instruction is executed frequently. Do not execute it any more than is necessary.
  - Cam data variables are global variables. You can therefore access or change the values of cam data variables from more than one task. If you change the values of cam data variables from more than one task, program the changes so that there is no competition in writing the value from more than one task.
  - If you use exclusive control of global variables between tasks for a cam data variable, do not use the cam data variable for motion control instructions while exclusive control is in effect for the cam data variable. An Incorrect Cam Table Specification error (error code: 5439 hex) will occur.
  - Do not execute this instruction while online edits are being saved. Otherwise the online edits may not be saved correctly.  
Saving of online edits refers to the following conditions.
    - a) For a combination of a CPU Unit with unit version 1.04 or later and Sysmac Studio version 1.05 or higher, saving of online edits continues until the dialog box that indicates saving data to built-in non-volatile memory closes.
    - b) For a combination of a CPU Unit with unit version 1.03 or before and Sysmac Studio version 1.04 or lower, online edits are saved from when you click the **Yes** Button in the confirmation dialog box until the dialog box closes.
- 

### ● Relation to CPU Unit Operating Modes

Cam data save processing for this instruction continues even if the operating mode of the CPU Unit changes to PROGRAM mode.

To see if cam data save processing is in progress in PROGRAM mode, place the Sysmac Studio online and monitor the `_MC_COM.Status.CamTableBusy` system-defined variable for motion control.

### ● Deleting Instruction with Online Editing

Cam data save processing for this instruction continues even if this instruction is deleted with online editing.



## Timing Charts

The following chart shows two ways to execute the instruction. A normal end is indicated for either method.

The first time, *Execute* is changed to TRUE and then it is changed to FALSE before execution of the instruction is completed.

The second time, the value of *Execute* is held.

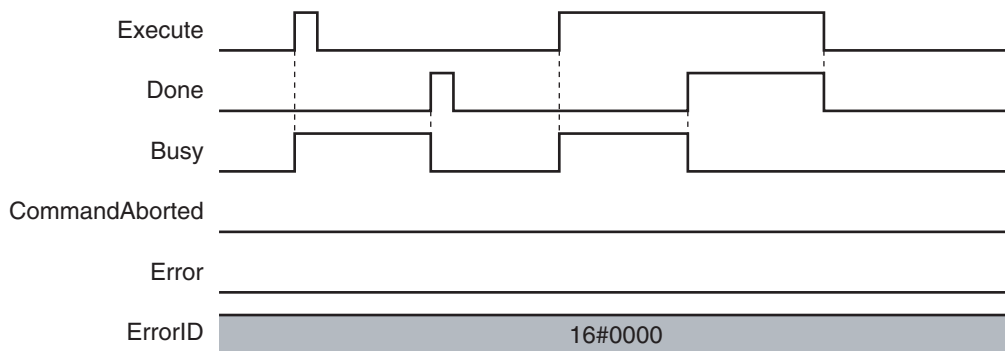

## Re-execution of Motion Control Instructions

This instruction cannot be re-executed.

A Motion Control Instruction Re-execution Disabled error (error code: 543B hex) occurs if re-execution is attempted.

## Multi-execution of Motion Control Instructions

For details on multi-execution of motion control instructions, refer to the *NJ/NX-series CPU Unit Motion Control User's Manual (Cat. No. W507)*.

### ● Execution during Execution of Other Instructions

Multi-execution of instructions cannot be used for this instruction if the cam table specified by *CamTable* is used by another instruction, such as *MC\_SetCamTableProperty*.

This instruction also cannot be executed during execution of another instance of the instruction.

### ● Execution of Other Instructions during Instruction Execution

Multi-execution of instructions cannot be used for other instructions, such as *MC\_SetCamTableProperty*, if the same cam table is specified with *CamTable* for this instruction.

This instruction also cannot be executed during execution of another instance of this instruction.

## Errors

If an error occurs during instruction execution, *Error* will change to TRUE.

You can find out the cause of the error by referring to the value output by *ErrorID* (Error Code).

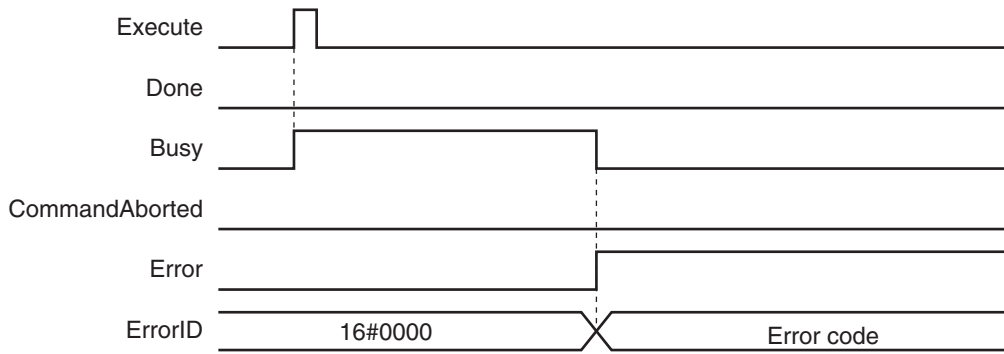

● **Error Codes**

Refer to the *NJ/NX-series Troubleshooting Manual (Cat. No. W503)* for instruction errors.

# MC\_Write

The MC\_Write instruction writes parts of the motion control parameters in the MC Function Module.

Instruction	Name	FB/ FUN	Graphic expression	ST expression
MC_Write	Write MC Setting	FB		<pre>MC_Write_instance (   Target :=parameter,   SettingValue :=parameter,   Execute :=parameter,   ParameterNumber :=parameter,   Done =&gt;parameter,   Busy =&gt;parameter,   CommandAborted =&gt;parameter,   Error =&gt;parameter,   ErrorID =&gt;parameter );</pre>



## Precautions for Correct Use

The values that are written by this instruction are not saved in non-volatile memory in the CPU Unit. Any values that are written are lost when the power supply to the Controller is turned OFF, when settings are downloaded, or when the MC Function Module is restarted. They return to the values that were set from the Sysmac Studio.

Use the Sysmac Studio and transfer the parameters to save them to non-volatile memory.



## Additional Information

Use the Synchronize Menu of the Sysmac Studio to download the project.

## Variables

### Input Variables

Name	Meaning	Data type	Valid range	Default	Description
Execute	Execute	BOOL	TRUE or FALSE	FALSE	The instruction is executed when the value of this variable changes to TRUE.

Name	Meaning	Data type	Valid range	Default	Description
Parameter-Number	Parameter Number	_eMC_PA-RAME-TER_NUM-BER	0: _mcChkVel 1: _mcChkAcc 2: _mcChkDec 3: _mcPosiChkTrq* <sup>1</sup> 4: _mcNegaChkTrq* <sup>1</sup> 5: _mcFELmt 6: _mcChkFELmt 7: _mcSwLmtMode 8: _mcPosiSwLmt 9: _mcNegaSwLmt 10: _mcInPosTime 11: _mcInPosRange* <sup>2</sup> 12: _mcStartVel* <sup>3</sup>	0* <sup>4</sup>	Specify the parameter to write. 0: Velocity Warning Value/Interpolation Velocity Warning Value 1: Acceleration Warning Value/Interpolation Acceleration Warning Value 2: Deceleration Warning Value/Interpolation Deceleration Warning Value 3: Positive Torque Warning Value 4: Negative Torque Warning Value 5: Following Error Over Value 6: Following Error Warning Value 7: Software Limits 8: Positive Software Limit 9: Negative Software Limit 10: In-position Check Time 11: In-position Range 12: Start Velocity

\*1. This parameter is enabled only for torque control.

\*2. A CPU Unit with unit version 1.01 or later and Sysmac Studio version 1.02 or higher are required to set this value.

\*3. A CPU Unit with unit version 1.10 or later and Sysmac Studio version 1.12 or higher are required to set this value.

\*4. The default value for an enumeration variable is actually not the number, but the enumerator.

## ● Parameter Number Data Types and Valid Ranges

Parameter	Data type	Valid range	Comments
0 Velocity Warning Value/Interpolation Velocity Warning Value	UINT	0 to 100	The unit is %.
1 Acceleration Warning Value/Interpolation Acceleration Warning Value	UINT	0 to 100	The unit is %.
2 Deceleration Warning Value/Interpolation Deceleration Warning Value	UINT	0 to 100	The unit is %.
3 Positive Torque Warning Value* <sup>1</sup>	UINT	0 to 1000	The unit is %.
4 Negative Torque Warning Value* <sup>1</sup>	UINT	0 to 1000	The unit is %.
5 Following Error Over Value	LREAL	Positive number	The unit is command units.* <sup>2</sup>
6 Following Error Warning Value	LREAL	Positive number	Set a value that is less than the value of the Following Error Over Value. The unit is command units.* <sup>2</sup>
7 Software Limits	_eMC_SWLMT_MODE	0: _mcNonSwLmt 1: _mcCmdDeceleration-Stop 2: _mcCmdImmediateStop 3: _mcActDecelerationStop 4: _mcActImmediateStop	0: Disabled 1: Deceleration stopping enabled for command position 2: Immediate stopping enabled for command position (stop using remaining pulses) 3: Deceleration stopping enabled for actual position 4: Immediate stopping enabled for actual position (stop using remaining pulses)

Parameter	Data type	Valid range	Comments
8 Positive Software Limit	LREAL	Negative number, positive number, or 0	The unit is command units. *2
9 Negative Software Limit	LREAL	Negative number, positive number, or 0	The unit is command units. *2
10 In-position Check Time	UINT	0 to 10000	The unit is milliseconds.
11 In-position Range	LREAL	Non-negative number	The unit is command units. *2
12 Start Velocity	LREAL	Non-negative number	The unit is command units/s. *2

\*1. This parameter is enabled only for torque control.

\*2. Refer to *Unit Conversion Settings* in the *NJ/NX-series CPU Unit Motion Control User's Manual (Cat. No. W507)* for information on command units.

## Output Variables

Name	Meaning	Data type	Valid range	Description
Done	Done	BOOL	TRUE or FALSE	TRUE when the instruction is completed.
Busy	Executing	BOOL	TRUE or FALSE	TRUE when the instruction is acknowledged.
CommandAborted	Command Aborted	BOOL	TRUE or FALSE	TRUE when the instruction is aborted.
Error	Error	BOOL	TRUE or FALSE	TRUE while there is an error.
ErrorID	Error Code	WORD	*1	Contains the error code when an error occurs. A value of 16#0000 indicates normal execution.

\*1. The upper four digits of the event code give the error code for ErrorID. Refer to the *NJ/NX-series Troubleshooting Manual (Cat. No. W503)* for the event codes.

### ● Output Variable Update Timing

Name	Timing for changing to TRUE	Timing for changing to FALSE
Done	When the instruction is completed.	<ul style="list-style-type: none"> <li>When <i>Execute</i> is TRUE and changes to FALSE.</li> <li>After one period when <i>Execute</i> is FALSE.</li> </ul>
Busy	When <i>Execute</i> changes to TRUE.	<ul style="list-style-type: none"> <li>When <i>Done</i> changes to TRUE.</li> <li>When <i>Error</i> changes to TRUE.</li> <li>When <i>CommandAborted</i> changes to TRUE.</li> </ul>
CommandAborted	When this instruction is canceled due to an error in another instruction.	<ul style="list-style-type: none"> <li>When <i>Execute</i> is TRUE and changes to FALSE.</li> <li>After one period when <i>Execute</i> is FALSE.</li> </ul>
Error	When there is an error in the execution conditions or input parameters for the instruction.	When the error is cleared.

## In-Out Variables

Name	Meaning	Data type	Valid range	Description
Target	Write Target	_sAXIS_REF or _sGROUP_REF	---	Specify the axis or axes group for which to write a parameter. *1
SettingValue	Setting Value	Depends on the data type of the specified variable. *2	---	Specify the value to write. The valid range follows the motion control parameter that is specified by <i>ParameterNumber</i> . Default: 0

- \*1. Specify a user-defined Axis Variable that was created in the Axis Basic Settings of the Sysmac Studio or a user-defined Axes Group Variable that was created in the Axes Group Basic Settings of the Sysmac Studio. (The default axis variable names are MC\_Axis\*. The default axes group variable names are MC\_Group\*.) You can also specify the system-defined variables for any of these: \_MC\_AX[\*], \_MC1\_AX[\*], \_MC2\_AX[\*], \_MC\_GRP[\*], \_MC1\_GRP[\*], or \_MC2\_GRP[\*].  
If you use Sysmac Studio version 1.29 or higher, you can specify the system-defined axis variable name, or system-defined axes group variable name for AT specification of a user-defined variable. This will allow you to specify the user-defined variable.  
If you use Sysmac Studio version 1.28 or lower, do not specify any user-defined variable created in the variable table.
- \*2. For details on the data types of variables, refer to *Parameter Number Data Types and Valid Ranges* on page 5-14.

### ● In-Out Variable Update Timing

Name	Write Timing
SettingValue	When <i>Done</i> changes to TRUE.

## Function

- The MC\_Write instruction writes the *SettingValue* to the system-defined variable for motion control specified by *Target* (Write Target) and *ParameterNumber* when *Execute* changes to TRUE.
- The parameters that are specified with the input variables are used if motion starts when *Status.Standby* in the Axes Group Variable or *Status.Standstill* in the Axis Variable is TRUE, and for multi-execution of instructions when the Buffer Mode is set to **Aborting**.  
Therefore these parameters are not applied when operation is continued after restarting or for multi-execution of instructions with Buffer Mode set to any value other than **Aborting**.



### Precautions for Correct Use

The values that are written by this instruction are not saved in non-volatile memory in the CPU Unit. Any values that are written are lost when the power supply to the Controller is turned OFF, when settings are downloaded, or when the MC Function Module is restarted. They return to the values that were set from the Sysmac Studio.  
Use the Sysmac Studio and transfer the parameters to save them to non-volatile memory.

### Timing Charts

The following timing chart shows the operation for when 20 is written to `_mcChkDec` (Deceleration Warning Value) in the axis parameter settings.

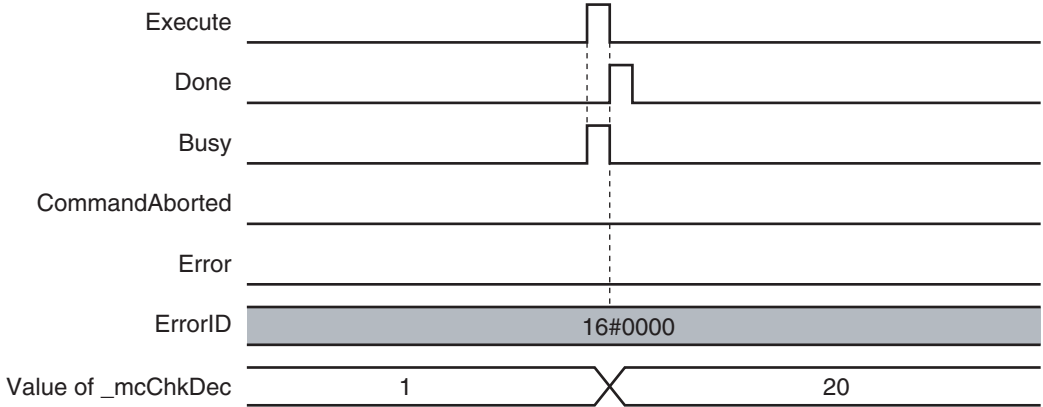

### Re-execution of Motion Control Instructions

If `Execute` for the same instance of this instruction changes to TRUE while `Busy` is TRUE, the instruction is re-executed. When that happens, the instruction overwrites the previous values of the `Target` (Write Target), `ParameterNumber`, and `SettingValue` with the values that are specified when `Execute` changes to TRUE.

### Multi-execution of Motion Control Instructions

For details on multi-execution of motion control instructions, refer to the *NJ/NX-series CPU Unit Motion Control User's Manual (Cat. No. W507)*.

### Errors

If an error occurs during instruction execution, `Error` will change to TRUE and parameters are not written. The values before the instruction was executed will be held.

You can find out the cause of the error by referring to the value output by `ErrorID` (Error Code).

#### ● Timing Chart When Error Occurs

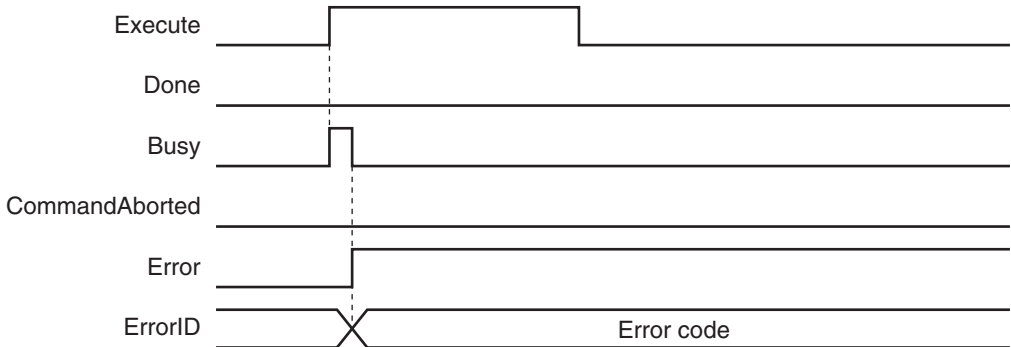

MC\_Write  
5  
Function

- **Error Codes**

Refer to the *NJ/NX-series Troubleshooting Manual (Cat. No. W503)* for instruction errors.



# MC\_GenerateCamTable

The MC\_GenerateCamTable instruction creates a cam table for the *CamProperty* (Cam Properties) and *CamNodes* (Cam Nodes) specified in the I/O variables.

Instruction	Name	FB/ FUN	Graphic expression	ST expression
MC_Generate-CamTable	Generate Cam Table	FB		<pre>MC_GenerateCamTable_instance (   CamTable :=parameter,   CamProperty :=parameter,   CamNodes :=parameter,   Execute :=parameter,   Done =&gt;parameter,   EndPointIndex =&gt;parameter,   Busy =&gt;parameter,   CommandAborted =&gt;parameter,   Error =&gt;parameter,   ErrorID =&gt;parameter,   ErrorParameterCode =&gt;parameter,   ErrorNodePointIndex =&gt;parameter );</pre>



## Precautions for Correct Use

You must create the cam table specified for this instruction with the Cam Editor on the Sysmac Studio and download it to the CPU Unit in advance.  
Use the Synchronize Menu of the Sysmac Studio to download the project.



## Version Information

A CPU Unit with unit version 1.08 or later and Sysmac Studio version 1.09 or higher are required to use this instruction.

## Variables

### Input Variables

Name	Meaning	Data type	Valid range	Default	Description
Execute	Execute	BOOL	TRUE or FALSE	FALSE	The instruction is executed when the value of this variable changes to TRUE.

## Output Variables

Name	Meaning	Data type	Valid range	Description
Done	Done	BOOL	TRUE or FALSE	TRUE when the instruction is completed.
EndPointIndex	End Point Index	UINT	Non-negative number	Contains the cam table end point index after the instruction is executed.
Busy	Executing	BOOL	TRUE or FALSE	TRUE when the instruction is acknowledged.
CommandAborted	Command Aborted	BOOL	TRUE or FALSE	TRUE when the instruction is aborted.
Error	Error	BOOL	TRUE or FALSE	TRUE while there is an error.
ErrorID	Error Code	WORD	*1	Contains the error code when an error occurs. A value of 16#0000 indicates normal execution.
ErrorParameter-Code	Parameter Detail Code	WORD	*1	Contains the attached information for some error codes. If the information is saved, the detail code of the parameter for which the error occurred is output.
ErrorNodePointIndex	Node Point Element Number	UINT	*1	Contains the attached information for some error codes. If the information is saved, the element number of the node point for which the error occurred is output.

\*1. The upper four digits of the event code give the error code for ErrorID. Refer to the *NJ/NX-series Troubleshooting Manual (Cat. No. W503)* for the event codes.

### ● Output Variable Update Timing

Name	Timing for changing to TRUE	Timing for changing to FALSE
Done	When creating cam table data is completed.	<ul style="list-style-type: none"> <li>When <i>Execute</i> is TRUE and changes to FALSE.</li> <li>After one period when <i>Execute</i> is FALSE.</li> </ul>
Busy	When <i>Execute</i> changes to TRUE.	<ul style="list-style-type: none"> <li>When <i>Done</i> changes to TRUE.</li> <li>When <i>Error</i> changes to TRUE.</li> <li>When <i>CommandAborted</i> changes to TRUE.</li> </ul>
CommandAborted	When there is a reason to abort this instruction.	<ul style="list-style-type: none"> <li>When <i>Execute</i> is TRUE and changes to FALSE.</li> <li>After one period when <i>Execute</i> is FALSE.</li> </ul>
Error	When there is an error in the execution conditions or input parameters for the instruction.	When the error is cleared.

## In-Out Variables

Name	Meaning	Data type	Valid range	Description
CamTable	Cam Table	ARRAY[0..N] OF _sMC_CAM_REF	---	Specify an array variable of _sMC_CAM_REF cam data structure as the cam table. *1 Specify a cam data variable that was created on the Cam Editor of the Sysmac Studio.

Name	Meaning	Data type	Valid range	Description
CamProperty	Cam Properties	_sMC_CAM_PROPERTY	---	Specify a variable of _sMC_CAM_PROPERTY cam property structures. Specify a user-defined variable with a data type of _sMC_CAM_PROPERTY or a cam property variable created on the Sysmac Studio.
CamNodes	Cam Nodes	ARRAY[0..N] OF _sMC_CAM_NODE	---	Specify an array variable of _sMC_CAM_NODE cam node structures. Specify a user-defined variable with a data type of _sMC_CAM_NODE or a cam node variable created on the Sysmac Studio. *2

\*1. *N* in the array variable is set automatically by the Sysmac Studio.

\*2. If you use a user-defined variable, create an array variable with a starting element number of 0 and a maximum of 358 array elements *N*.

## Function

- The MC\_GenerateCamTable instruction calculates cam data based on *CamProperty* (Cam Properties) and *CamNodes* (Cam Nodes) that are specified for the in-out variables when *Execute* changes to TRUE.
- The calculated cam data values are written to *CamTable* specified for the in-out variable.
- The items in *CamProperty* (Cam Properties) and *CamNodes* correspond to the items that are set with the Cam Editor of the Sysmac Studio.
- When writing the cam table is completed, the end point index of the cam table is updated and the number of the last cam element is output to *EndPointIndex*.  
It is not necessary to execute the MC\_SetCamTableProperty (Set Cam Table Properties) instruction after completion of the MC\_GenerateCamTable instruction.
- While the cam table creation process is in progress, *\_MC\_COM.Status.GenerateCamBusy* (Cam Table Creation Busy) in the MC Common variable of the motion control system variables will be TRUE.

Cam table before instruction execution

Element No.	Phase	Displacement
0	0.0	0.0
1	0.0	0.0
...	...	...
179	0.0	0.0
180	0.0	0.0
181	0.0	0.0
...	...	...

Cam table after instruction execution

Element No.	Phase	Displacement
0	0.0	0.0
1	1.0	1.0
...	...	...
179	179.0	199.0
180	180.0	200.0
181	0.0	0.0
...	...	...

The cam data is calculated and written to the table when the instruction is executed.

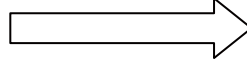

Cam end point →

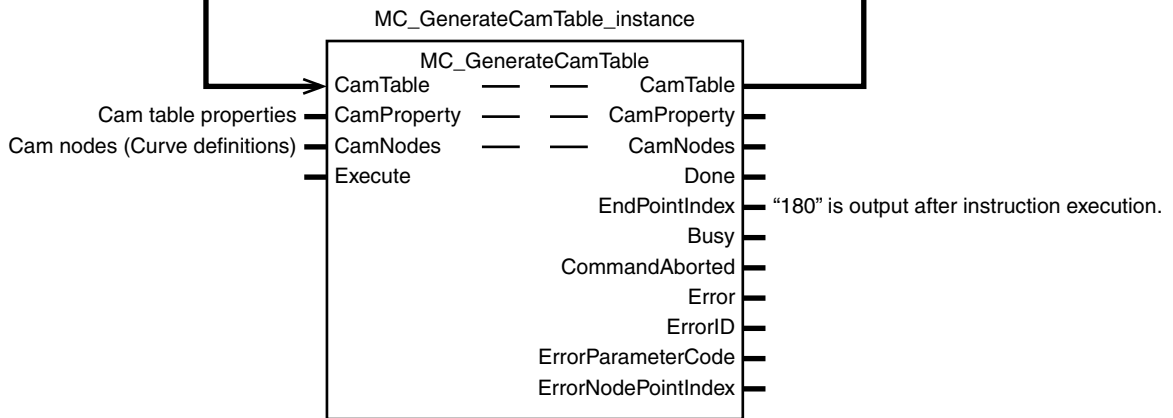



### Precautions for Correct Use

- Set the maximum number of cam data to a value that is equal to or higher than the number of data in the cam table that will be created by the instruction.
- Although you can specify a free curve as the curve shape on the Cam Editor of the Sysmac Studio, you cannot specify a free curve with this instruction.
- This instruction has a considerably longer processing time compared with other instructions. The processing time is greatly affected by the processing load on the CPU Unit. If the next instruction is executed taking the completion of this instruction as a trigger, take care with the timing of execution of the next instruction.
- Even if the same setting items are set for the Cam Editor of the Sysmac Studio and this instruction, differences in internal processing may create differences in the values of the cam data that is created.
- Cam data variables are global variables. You can therefore access or change the values of cam data variables from more than one task. If you change the values of cam data variables from more than one task, program the changes so that there is no competition in writing the value from more than one task.
- If you use exclusive control of global variables between tasks for a cam data variable, do not use the cam data variable for motion control instructions while exclusive control is in effect for the cam data variable. An Incorrect Cam Table Specification error (error code: 5439 hex) will occur.
- If you create the variables that you specify for *CamProperty* (Cam Properties) and *CamNodes* as user-defined variables, set the Retain attributes of the variables not to retain their initial values. If you change the values of the variables and use them again after changing the mode to PROGRAM mode or cycling the power supply, set the Retain attributes of the variables to retain their values.  
The Retain attributes of Cam Properties variables and Cam Nodes variables created on the Sysmac Studio are always set to retain the values of the variables.
- The cam data variables that are created with this instruction are not saved in the non-volatile memory of the CPU Unit. To save them in non-volatile memory, execute the MC\_SaveCamTable instruction.
- Do not change the values in the array variable that is specified for *CamNodes* during execution of the instruction. The instruction may cause unintended operation.
- If the *CamNodes* array is large, the instruction execution time increases and the task period may be exceeded. If the task period is exceeded, a Task Period Exceeded error (error code: 6001 hex) will occur. Adjust the array size or change the task period.
- The creation process for the cam table continues even if the operating mode is changed from RUN mode to PROGRAM mode during execution of the instruction. If you then change back to RUN mode and execute the instruction for the same cam table, a Motion Control Instruction Multi-execution Disabled error (error code: 543C hex) will occur.



### Additional Information

- You can check the maximum number of cam data in the cam table with the data type of the global variable on the Sysmac Studio or by executing the SizeOfAry (Get Number of Array Elements) instruction in the user program.
- You can calculate the number of cam data in the cam table that is created by this instruction with the following formula.

$$T_{cd} = \sum_{k=0}^{n-1} \left( \frac{M_k - M_{k-1}}{P_k} \right) + 1$$

- $T_{cd}$  : Number of cam data in cam table
- $k$  : Element number in cam node array variable
- $M_k$  : *Phase* (Master Axis Phase) of element number  $k$  in cam node array variable  
However, *Phase* (Master Axis Phase) of  $M_{k-1}$  is taken as 0.
- $P_k$  : *PhasePitch* (Phase Pitch) of element number  $k$  in cam node array variable
- $n$  : Number of node points

**Note** If *Phase* (Master Axis Phase) cannot be divided evenly by *PhasePitch*, the value is rounded up at the first decimal place.

- Do not use this instruction to create a cam table with more than 65,535 cam data.
- You can check the number of cam data in the created cam table with *EndPointIndex*. You can use an HMI to display the value of *EndPointIndex* to improve the resolution of the cam table, add node points, or make other adjustments.
- Refer to information on *MC\_CamIn* on page 3-173 for details on the cam data in cam tables.
- Refer to information on *MC\_SetCamTableProperty* on page 5-2 for information on the end point index.
- Refer to the *Sysmac Studio Version 1 Operation Manual (Cat. No. W504)* for information on the setting items for *CamProperty* (Cam Properties) and *CamNodes*.
- Refer to the *Sysmac Studio Version 1 Operation Manual (Cat. No. W504)* for information on the relationship between curve shapes, connecting velocities, and connecting accelerations.

### ● Relation to CPU Unit Operating Modes

The cam table creation process for this instruction continues even if the operating mode of the CPU Unit changes to PROGRAM mode.

### ● Deleting the Instruction with Online Editing

The cam table creation process for this instruction continues even if you delete the instruction in online editing.

### ● Execution of an MC Test Run

The *CommandAborted* output variable from the instruction changes to TRUE if you execute an MC Test Run during the cam table creation process for this instruction, but the creation process continues.

## Instruction Details

This section describes the instruction in detail.

## ● Cam Property Structure (`_sMC_CAM_PROPERTY` Data Type)

The cam property structure (`_sMC_CAM_PROPERTY`) is used to specify the properties. Some of the members correspond to the cam table properties that are set with the Cam Editor of the Sysmac Studio.

This cam property structure is used for the *CamProperty* (Cam Properties) in-out variable that is specified for this instruction.

The members of the cam property structure are described in the following table.

Name	Meaning	Data type	Valid range	Description
InitVel	Initial Velocity	REAL	Negative number* <sup>1</sup> , positive number* <sup>1</sup> , or 0	Set the velocity when operation is started at the start node (phase = 0 and displacement = 0). The initial velocity is valid when the curve shape for the next cam node after the start node is set to polynomic 3 or polynomic 5. The unit is command units/s.
InitAcc	Initial Acceleration	REAL	Negative number* <sup>1</sup> , positive number* <sup>1</sup> , or 0	Set the acceleration when operation is started at the start node (phase = 0 and displacement = 0). The initial acceleration is valid when the curve shape for the next cam node after the start node is set to polynomic 5. The unit is command units/s <sup>2</sup> .
CycleTime	Cycle Time	REAL	Positive number* <sup>1</sup>	Specify the time for one cam operation cycle. The unit is seconds.

\*1. Specify a value that has an absolute value of 0.001 or greater. The value is rounded to the fourth decimal place.

## ● Cam Node Structure (`_sMC_CAM_NODE` Data Type)

The cam node structure (`_sMC_CAM_NODE`) is used to define the curve shapes. Some of the members correspond to the **Cam Nodes** items that are set with the Cam Editor of the Sysmac Studio.

	Master axis	Slave axis	Cam curve	Connecting velocity	Connecting acceleration	Phase pitch
Start node	0.000	0.000				
CamNodes[0]	1.000	1.000	Polynomic 5	<input checked="" type="checkbox"/> 100.000	<input checked="" type="checkbox"/> 10.000	0.010
CamNodes[1]	2.000	2.000	Polynomic 3	<input checked="" type="checkbox"/> 100.000	<input type="checkbox"/> 1176.000	0.010

This cam node structure is used for the *CamNodes* in-out variable that is specified for this instruction. An element in the cam node array variable is called a node point. The number of elements in the array variable must be equal to or greater than the number of node points that is set.

The node point that is the start point of the cam profile curve (phase = 0, displacement = 0) is called the start node. Except for the start node, the node points in the array variable are in the order of the element numbers.

If you specify a positive number that is 0.001 or higher for *Phase* (Master Axis Phase), the node is valid. If you specify 0, that node and all following nodes are invalid. However, if you set *Phase* (Master Axis Phase) for element number 0 to 0, an error occurs.

The following example shows five valid nodes and 10 elements in an array variable.

Element No.	Phase (Master Axis Phase)
0	Positive number
...	...
4	Positive number
5	0
6	Any value
...	...
9	Any value

Valid nodes { 0, ..., 4 }

Invalid nodes { 5, 6, ..., 9 }

Specify the values of *Phase* (Master Axis Phase) so that they increase in the order of the array element numbers. (The previous value must be less than the current value.)

The following table shows the members of the cam node structure.

Name	Meaning	Data type	Valid range	Description
Phase	Master Axis Phase	REAL	Non-negative number <sup>*1*2</sup>	Set the phase of the master axis at the node point. The unit is command units.
Distance	Slave Axis Displacement	REAL	Negative number <sup>*1*2</sup> , positive number <sup>*1*2</sup> , or 0	Set the displacement of the slave axis at the node point. The unit is command units.
Curve	Curve Shape	_eMC_CAM_CURVE	0: _mcConstantLine 1: _mcStraightLine 2: _mcParabolic 3: _mcModifiedConstantVel 4: _mcModifiedTrapezoid 5: _mcModifiedSine 6: _mcCycloidal 7: _mcTrapeclloid 8: _mcReverseTrapeclloid 9: _mcSimpleHarmonic 10: _mcDoubleHarmonic 11: _mcReverseDoubleHarmonic 12: _mcNC2Curve 13: _mcPolynomic3 14: _mcPolynomic5	Specify the shape of the cam curve to the node point. 0: Constant <sup>*3</sup> 1: Straight line 2: Parabolic 3: Modified constant velocity 4: Modified trapezoid 5: Modified sine 6: Cycloidal 7: Trapeclloid 8: Reverse trapeclloid 9: Simple harmonic 10: Double harmonic 11: Reverse double harmonic 12: NC2 curve 13: Polynomic 3 14: Polynomic 5
ConnectingVelocityEnable	Connecting Velocity Enable	BOOL	TRUE or FALSE	Set to TRUE to enable the specified connecting velocity when the specified curve shape is polynomic 3 or polynomic 5. Set to FALSE to disable the connecting velocity.
ConnectingVel	Connecting Velocity	REAL	Negative number <sup>*1</sup> , positive number <sup>*1</sup> , or 0	If the specified curve shape is polynomic 3 or polynomic 5, you can specify the velocity of the connecting section to the next curve. Use this setting for smooth connections between curves. The unit is command units/s.



Name	Meaning	Data type	Valid range	Description
ConnectingAccEnable	Connecting Acceleration Enable	BOOL	TRUE or FALSE	Set to TRUE to enable the specified connecting acceleration when the specified curve shape is polynomial 5. Set to FALSE to disable the connecting acceleration.
ConnectingAcc	Connecting Acceleration	REAL	Negative number* <sup>1</sup> , positive number* <sup>1</sup> , or 0	If the specified curve shape is polynomial 5, you can specify the acceleration of the connecting section to the next curve. Use this setting for smooth connections between curves. The unit is command units/s <sup>2</sup> .
PhasePitch	Phase Pitch	REAL	Positive number* <sup>1</sup>	The phase between node points is divided by the specified pitch width. * <sup>4</sup> The unit is command units.

- \*1. Specify a value that has an absolute value of 0.001 or greater. The value is rounded to the fourth decimal place.
- \*2. *Phase* (Master Axis Phase) and *Distance* (Slave Axis Displacement) are effective to seven digits. If you enter more than seven digits, the digits that are not effective are truncated. If a truncated value is the same as the value of another value in *Phase* (Master Axis Phase), a Cam Node Master Axis Phase Not in Ascending Order error (error code: 5740 hex) occurs. Enter values in ascending order for seven digits or less.
- \*3. If you specify a straight line with constant displacement, *Distance* (Slave Axis Displacement) is disabled and the value that is specified for the previous node point is used for processing. If the array element number is 0 and you specify a straight line with constant displacement, *Distance* (Slave Axis Displacement) is treated as 0.
- \*4. Make the settings so that the total of all cam data that is created for each node point is 65,535 or less.

### ● Example of Creating a Cam Table

This section provides an example of creating a cam table with this instruction.

There are four elements in the array variable that is specified for *CamNodes*. *\_mcStraightLine* (Straight Line) is specified for *Curve* (Curve Shape). *ConnectingVel* (Connecting Velocity) and *ConnectingAcc* (Connecting Acceleration) are disabled, as are *InitVel* (Initial Velocity) and *InitAcc* (Initial Acceleration) in *CamProperty* (Cam Properties), so they are not given here. The values of *Phase* (Master Axis Phase) and *Distance* (Slave Axis Displacement) are given in the following table.

Element number in CamNodes array variable	Phase (Master Axis Phase)	Distance (Slave Axis Displacement)	Curve (Curve Shape)	PhasePitch (Phase Pitch)
0	180.000	180.000	_mcStraightLine	0.100
1	360.000	0.000	_mcStraightLine	0.100
2	0.00	---	---	---
3	---	---	---	---

This example uses a cam data variable with 4,000 elements that was created in advance with the Cam Editor of the Sysmac Studio. All phases and displacements are set to “undefined.”

The cam data variable for the cam table is as shown in the following table before the instruction is executed.

Element No.	Phase (Phase)	Distance (Displacement)
0	(Undefined)	(Undefined)
1	(Undefined)	(Undefined)
...		
1799	(Undefined)	(Undefined)

Element No.	Phase (Phase)	Distance (Displacement)
1800	(Undefined)	(Undefined)
1801	(Undefined)	(Undefined)
...		
3599	(Undefined)	(Undefined)
3600	(Undefined)	(Undefined)
3601	(Undefined)	(Undefined)
...		
3999	(Undefined)	(Undefined)

Next, we describe the sequence of changes that occur in the cam data variable as the instruction is executed. The locations that changed are showed by filled backgrounds.

When the MC\_GenerateCamTable instruction is executed, 0 is written to the phase and displacement of element 0 of the cam data variable.

Element No.	Phase (Phase)	Distance (Displacement)
<b>0</b>	<b>0.0</b>	<b>0.0</b>
1	(Undefined)	(Undefined)
...		
1799	(Undefined)	(Undefined)
1800	(Undefined)	(Undefined)
1801	(Undefined)	(Undefined)
...		
3599	(Undefined)	(Undefined)
3600	(Undefined)	(Undefined)
3601	(Undefined)	(Undefined)
...		
3999	(Undefined)	(Undefined)

Next, the number of cam data and the phase and displacement for each cam data are calculated from the start node to the node point according to the specified values for element 0 in *CamNodes*. The number of cam data calculates as 1,800, so the phases and displacements of element 1 to 1800 are written to the cam data variable.

Element No.	Phase (Phase)	Distance (Displacement)
0	0.0	0.0
<b>1</b>	<b>0.1</b>	<b>0.1</b>
...		
<b>1799</b>	<b>179.9</b>	<b>179.9</b>
<b>1800</b>	<b>180.0</b>	<b>180.0</b>
1801	(Undefined)	(Undefined)
...		
3599	(Undefined)	(Undefined)
3600	(Undefined)	(Undefined)
3601	(Undefined)	(Undefined)
...		
3999	(Undefined)	(Undefined)

In the same way, the number of cam data and the phase and displacement for each cam data are calculated between node points according to the specified values for element 1 in *CamNodes*. The

number of cam data calculates as 1,800, so the phases and displacements of element 1801 to 3600 are written to the cam data variable.

Element No.	Phase (Phase)	Distance (Displacement)
0	0.0	0.0
1	0.1	0.1
...		
1799	179.9	179.9
1800	180.0	180.0
<b>1801</b>	<b>180.1</b>	<b>179.9</b>
...		
<b>3599</b>	<b>359.9</b>	<b>0.1</b>
<b>3600</b>	<b>360.0</b>	<b>0.0</b>
3601	(Undefined)	(Undefined)
...		
3999	(Undefined)	(Undefined)

Next, calculations are ended because element 2 in *CamNodes* has an invalid node. The cam data in elements 3601 and higher in the cam data variable are invalid, so 0 is written as the phases.

Element No.	Phase (Phase)	Distance (Displacement)
0	0.0	0.0
1	0.1	0.1
...		
1799	179.9	179.9
1800	180.0	180.0
1801	180.1	179.9
...		
3599	359.9	0.1
3600	360.0	0.0
<b>3601</b>	<b>0.0</b>	(Undefined)
...		
3999	(Undefined)	(Undefined)

However, if there were only 3601 elements in the cam data variable that was created with the Cam Editor of the Sysmac Studio, no invalid cam data would exist, so 0 would not be written as the value of the phase of element 3601.

Element No.	Phase (Phase)	Distance (Displacement)
0	0.0	0.0
1	0.1	0.1
...		
1799	179.9	179.9
1800	180.0	180.0
1801	180.1	179.9
...		
3599	359.9	0.1
3600	360.0	0.0

The number of the last element in the cam data variable that was written is output to the *EndPointIndex* output variable of the instruction as the end point index. In this example, 3600 would be output.

This completes execution of the instruction.

### ● Cam Table Displacement Overflow

A Cam Table Displacement Overflow error (error code: 5742 hex) will occur if the value of *Distance* (Slave Axis Displacement) in the cam data calculated by the instruction exceeds the valid range of REAL data. The value of the relevant *Distance* (Slave Axis Displacement) will not change, and creating the cam table will be aborted.

A Cam Table Displacement Overflow error can occur only when *Curve* (Curve Shape) is set to polynomial 3 or polynomial 5. If this error occurs, refer to the following calculation methods for displacements for polynomial 3 or polynomial 5 and correct the values in the *CamProperty* (Cam Properties) and *CamNodes* in-out variables.

### ● Displacement Calculation Method for Polynomial 3

The element number in the array variable specified for *CamNodes* is “m.”

When polynomial 3 is specified for *Curve* (Curve Shape) of element m, *Phase* of element m-1 is set as the initial value  $P_{init}$  of the master axis phase. In the same way, *Distance* is set to the initial value  $d_{init}$  of the slave axis displacement. When  $m = 0$ , calculations are performed with  $P_{init}$  and  $d_{init}$  set to 0.

Also, *Phase* of element m is set to the final value  $P_{final}$  of the master axis phase. In the same way, *Distance* for element m is set to the final value  $d_{final}$  of the slave axis displacement.

$d(n)$  is calculated as shown below when  $d(n)$  is *Distance* (Slave Axis Displacement) of the nth cam data from  $d_{init}$ .

**When  $0 \leq n < N$ ,**

$$d(n) = d_{init} + (d_{final} - d_{init}) \cdot \sum_{i=f}^3 a_i \cdot \left( \frac{\text{pitch}}{(P_{final} - P_{init})} \cdot n \right)^i$$

**When  $n = N$ ,**

$$d(n) = d_{final}$$

However, when  $(P_{final} - P_{phase}) / \text{pitch}$  is an integer,

$$N = \frac{P_{final} - P_{phase}}{\text{pitch}}$$

When  $(P_{final} - P_{phase}) / \text{pitch}$  is not an integer,

$$N = \text{floor} \left( \frac{P_{final} - P_{phase}}{\text{pitch}} \right) + 1$$

$$a_1 = \frac{V_{\text{init}} \cdot T}{(d_{\text{final}} - d_{\text{init}})}$$

$$a_2 = 3 - (2 \cdot V_{\text{init}} + V_{\text{fin}}) \cdot \frac{T}{(d_{\text{final}} - d_{\text{init}})}$$

$$a_3 = (V_{\text{init}} + V_{\text{fin}}) \cdot \frac{T}{(d_{\text{final}} - d_{\text{init}})} - 2$$

$$T = \text{CycleTime} \cdot \frac{(P_{\text{final}} - P_{\text{init}})}{P_{\text{max}}}$$

pitch: *PhasePitch* of element *m* in *CamNodes*

CycleTime: *CycleTime* (Cycle Time) in *CamProperty* (Cam Properties)

$P_{\text{max}}$ : Largest value of *Phase* (Master Axis Phase) in valid nodes of *CamNodes*

$V_{\text{init}}$ : Initial velocity of cam profile curve [command units/s]

However, when  $m = 0$ ,

$$V_{\text{init}} = \text{InitVel} \text{ (Initial Velocity) in } \text{CamProperty} \text{ (Cam Properties)}$$

When  $m \geq 1$  and *Curve* (Curve Shape) of element *m-1* in *CamNodes* is a straight line (*\_mcStraightLine*),

$$V_{\text{init}} = \frac{(d_{\text{final}} \text{ of element } m-1 - d_{\text{init}} \text{ of element } m-1)}{(P_{\text{final}} \text{ of element } m-1 - P_{\text{init}} \text{ of element } m-1)} \cdot \frac{P_{\text{max}}}{\text{CycleTime}}$$

When  $m \geq 1$  and *Curve* (Curve Shape) of element *m-1* in *CamNodes* is polynomial 3 or polynomial 5,

- *ConnectingVelEnable* (Connecting Velocity Enable) of element *m-1* in *CamNodes* is TRUE

$$V_{\text{init}} = \text{ConnectingVel} \text{ (Connecting Velocity) of element } m-1 \text{ in } \text{CamNodes}$$

- *ConnectingVelEnable* (Connecting Velocity Enable) of element *m-1* in *CamNodes* is FALSE

$$V_{\text{init}} = 0$$

When  $m \geq 1$  and the Curve Shape is other than the above,

$$V_{\text{init}} = 0$$

$V_{\text{fin}}$ : Final velocity of cam curve [command units/s]

However, when *ConnectingVelEnable* (Connecting Velocity Enable) of element *m* in *CamNodes* is TRUE,

$$V_{\text{fin}} = \text{ConnectingVel} \text{ (Connecting Velocity) of element } m \text{ in } \text{CamNodes}$$

When *ConnectingVelEnable* (Connecting Velocity Enable) of element *m* in *CamNodes* is FALSE,

- *Curve* (Curve Shape) of element *m+1* in *CamNodes* is a straight line (*\_mcStraightLine*)

$$V_{\text{fin}} = \frac{(d_{\text{final}} \text{ of element } m+1 - d_{\text{init}} \text{ of element } m+1)}{(P_{\text{final}} \text{ of element } m+1 - P_{\text{init}} \text{ of element } m+1)} \cdot \frac{P_{\text{max}}}{\text{CycleTime}}$$

- *Curve* (Curve Shape) of element m+1 in *CamNodes* is not a straight line (`_mcStraightLine`)

$$V_{fin} = 0$$

### ● Displacement Calculation Method for Polynomic 5

The element number in the array variable specified for *CamNodes* is “m.”

When polynomic 5 is specified for *Curve* (Curve Shape) of element m, *Phase* of element m-1 is set as the initial value  $P_{init}$  of the master axis phase. In the same way, *Distance* is set to the initial value  $d_{init}$  of the slave axis displacement. When  $m = 0$ , calculations are performed with  $P_{init}$  and  $d_{init}$  set to 0.

Also, *Phase* of element m is set to the final value  $P_{final}$  of the master axis phase. In the same way, *Distance* for element m is set to the final value  $d_{final}$  of the slave axis displacement.

$d(n)$  is calculated as shown below when  $d(n)$  is *Distance* (Slave Axis Displacement) of the nth cam data from  $d_{init}$ .

**When  $0 \leq n < N$ ,**

$$d(n) = d_{init} + (d_{final} - d_{init}) \cdot \sum_{i=f}^5 a_i \cdot \left( \frac{\text{pitch}}{(P_{final} - P_{init})} \cdot n \right)^i$$

**When  $n = N$ ,**

$$d(n) = d_{final}$$

However, when  $(P_{final} - P_{phase}) / \text{pitch}$  is an integer,

$$N = \frac{P_{final} - P_{phase}}{\text{pitch}}$$

When  $(P_{final} - P_{phase}) / \text{pitch}$  is not an integer,

$$N = \text{floor} \left( \frac{P_{final} - P_{phase}}{\text{pitch}} \right) + 1$$

$$a_1 = \frac{V_{init} \cdot T}{(d_{final} - d_{init})}$$

$$a_2 = \frac{A_{init} \cdot T^2}{2 \cdot (d_{final} - d_{init})}$$

$$a_3 = \frac{- \left( (3A_{init} - A_{fin}) \cdot \frac{T^2}{(d_{final} - d_{init})} + (8V_{fin} + 12V_{init}) \cdot \frac{T}{(d_{final} - d_{init})} - 20 \right)}{2}$$

$$a_4 = \left( (1.5A_{init} - A_{fin}) \cdot \frac{T^2}{(d_{final} - d_{init})} + (7V_{fin} + 8V_{init}) \cdot \frac{T}{(d_{final} - d_{init})} - 15 \right)$$

$$a_5 = \frac{\left[ (A_{init} - A_{fin}) \cdot \frac{T^2}{(d_{final} - d_{init})} + (6V_{fin} + 6V_{init}) \cdot \frac{T}{(d_{final} - d_{init})} - 12 \right]}{2}$$

$$T = CycleTime \cdot \frac{(P_{final} - P_{init})}{P_{max}}$$

pitch: *PhasePitch* of element *m* in *CamNodes*

CycleTime: *CycleTime* (Cycle Time) in *CamProperty* (Cam Properties)

$P_{max}$ : Largest value of *Phase* (Master Axis Phase) in valid nodes of *CamNodes*

$A_{init}$ : Initial acceleration of cam profile curve [command units/s<sup>2</sup>]

However, when  $m = 0$ ,

$$A_{init} = InitAcc \text{ (Initial Acceleration) in } CamProperty \text{ (Cam Properties)}$$

When  $m \geq 1$  and *Curve* (Curve Shape) of element  $m-1$  in *CamNodes* is polynomial 5,

- *ConnectingVelEnable* (Connecting Velocity Enable) of element  $m-1$  in *CamNodes* is TRUE

$$A_{init} = ConnectingAcc \text{ (Connecting Acceleration) of element } m-1 \text{ in } CamNodes$$

- *ConnectingVelEnable* (Connecting Velocity Enable) of element  $m-1$  in *CamNodes* is FALSE

$$A_{init} = 0$$

When  $m \geq 1$  and *Curve* (Curve Shape) of element  $m-1$  in *CamNodes* is not polynomial 5,

$$A_{init} = 0$$

$A_{fin}$ : Final acceleration of cam curve [command units/s<sup>2</sup>]

However, when *ConnectingAccEnable* (Connecting Acceleration Enable) of element  $m$  in *CamNodes* is TRUE,

$$A_{fin} = ConnectingAcc \text{ (Connecting Acceleration) of element } m \text{ in } CamNodes$$

When *ConnectingAccEnable* (Connecting Acceleration Enable) of element  $m$  in *CamNodes* is FALSE,

$$A_{fin} = 0$$

Refer to *Displacement Calculation Method for Polynomial 3* on page 5-30 for information on  $V_{init}$  (initial velocity of cam profile curve [command units/s]) and  $V_{fin}$  (final velocity of cam curve [command units/s]).

## Timing Charts

*Busy* (Executing) changes to TRUE at the same time as *Execute* changes to TRUE. *\_MC\_COM.Status.GenerateCamBusy* (Cam Table Creation Busy) changes to TRUE in the next period.

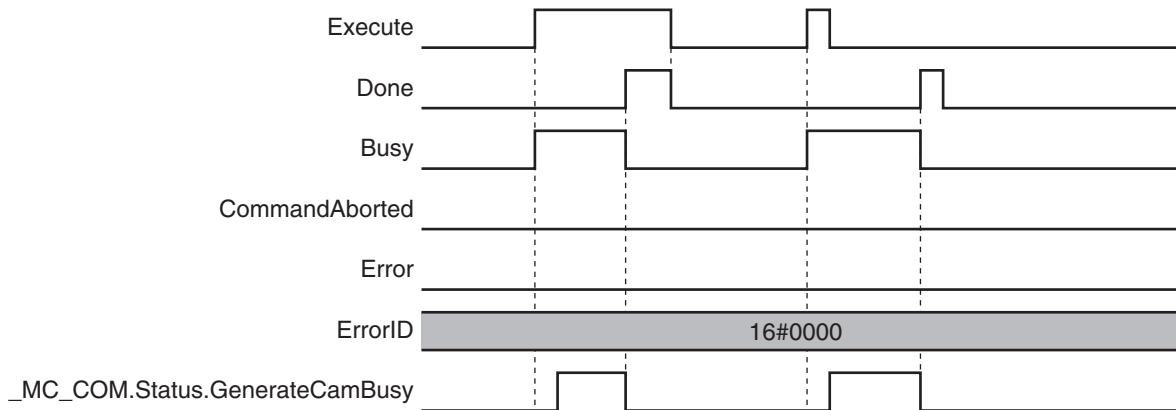

## Re-execution of Motion Control Instructions

This instruction cannot be re-executed.

A Motion Control Instruction Re-execution Disabled error (error code: 543B hex) occurs if re-execution is attempted. However, creation of the cam table will continue.

## Multi-execution of Motion Control Instructions

### ● Execution during Execution of Other Instructions

Multi-execution of instructions cannot be used for this instruction if the cam table specified by *CamTable* is used by another instruction, such as `MC_CamIn`, `MC_SaveCamTable`, or `MC_SetCamTableProperty`.

### ● Execution of Other Instructions during Instruction Execution

Multi-execution of instructions cannot be used for other instructions, such as `MC_CamIn`, `MC_SaveCamTable`, or `MC_SetCamTableProperty` if the same cam table is specified with *CamTable* for this instruction.

### ● Execution during Execution of This Instruction

You cannot execute another instance of this instruction while this instruction is being executed. You also cannot execute this instruction while `_MC_COM.Status.GenerateCamBusy` (Cam Table Creation Busy) is TRUE. Perform exclusive control with `_MC_COM.Status.GenerateCamBusy` (Cam Table Creation Busy) or with the output variables from the instruction.

If more than one instance of this instruction is executed during the same period, `_MC_COM.Status.GenerateCamBusy` (Cam Table Creation Busy) will be FALSE during that period. Perform exclusive control with *Busy* (Executing) from a different instance.

## Errors

If an error occurs during instruction execution, *Error* will change to TRUE.

You can find out the cause of the error by referring to the value output by *ErrorID* (Error Code).



Depending on *ErrorID* (Error Code), attached information is output to *ErrorParameterCode* (Parameter Detail Code) and *ErrorNodePointIndex* (Node Point Element Number).

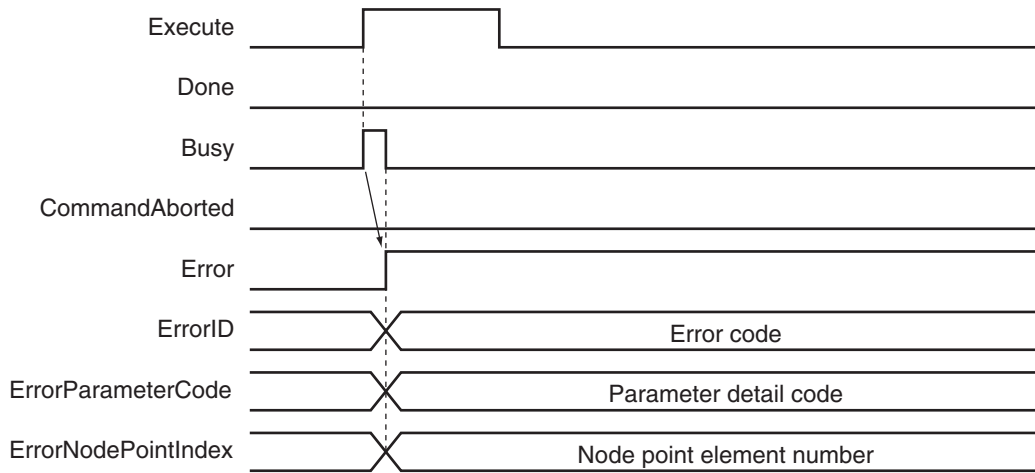

Even if an error occurs during execution of the instruction, the cam data variable specified for *CamTable* retains the same values as before the execution.

However, the values in the cam data variable are not retained in the following cases.

- When the parameter specified for *CamNodes* is changed after *Execute* changes to TRUE.
- The value of a cam data *Distance* (Slave Axis Displacement) calculated by this instruction exceeds the valid range of REAL data.

If the values in the cam data variable are not retained, the cam table will be in an illegal state. An error will occur if you specify a cam table that is an illegal state for the *MC\_CamIn*, *MC\_SaveCamTable*, or *MC\_SetCamTableProperty* instruction.

To recover a cam table from an illegal state, reset the error that occurred for the instruction and then perform one of the following actions.

- Execute this instruction for the cam table that is in an illegal state again and complete creation of the cam table.
- Download the cam table from the Sysmac Studio.
- Cycle the power supply to the CPU Unit.

An error code is not output to *ErrorID* (Error Code) if an error occurs for this instruction in PROGRAM mode or during an MC Test Run. If that occurs, check the cause of the error in the event log or in the *\_MC\_COM.MFaultLvl.Code* (MC Common Minor Fault Code) system-defined variables for motion control.

## ● Error Codes

Refer to the *NJ/NX-series Troubleshooting Manual (Cat. No. W503)* for instruction errors.

## Sample Programming

This sample programming writes data to a cam data variable in the cam table that was created on Cam Editor of the Sysmac Studio.

## Parameter Settings

The minimum settings required for this sample programming are given below.

### ● Axis Parameters

#### Axis Type

Axis	Axis type
Axis 1	Servo axis
Axis 2	Servo axis

#### Count Modes

Axis	Count mode
Axis 1	Rotary Mode
Axis 2	Rotary Mode

#### Ring Counter

Axis	Modulo maximum position	Modulo minimum position
Axis 1	360	0
Axis 2	360	0

#### Unit of Display

Axis	Unit of display
Axis 1	degree
Axis 2	degree

## Data That Is Written

This section describes the initial values of the cam property variable and cam node variable that were created in advanced with the Cam Editor of the Sysmac Studio and the values that are written with this sample programming.

### ● Cam Properties

The initial values of the cam property variable are given in the following table.

InitVel (Initial Velocity)	InitAcc (Initial Acceleration)	CycleTime (Cycle Time)
0.000	0.000	1.000

The sample programming changes *CycleTime* (Cycle Time) to 0.8.

InitVel (Initial Velocity)	InitAcc (Initial Acceleration)	CycleTime (Cycle Time)
0.000	0.000	<b>0.800</b>

## ● Cam Nodes

The initial values of the cam node variable are given in the following table.

Element No.	Phase (Master Axis Phase)	Distance (Slave Axis Displacement)	Curve (Curve Shape)	Connecting-VelEnable (Connecting Velocity Enable)	ConnectingVel (Connecting Velocity)	ConnectingAccEnable (Connecting Acceleration Enable)	ConnectingAcc (Connecting Acceleration)	Phase-Pitch (Phase Pitch)
0	180.000	-100.000	_mcModifiedSine	FALSE	0.000	FALSE	0.000	0.010
1	360.000	0.000	_mcPolynomial5	FALSE	0.000	FALSE	0.000	0.010
2	0.0	0.0	_mcConstantLine	FALSE	0.000	FALSE	0.0	0.0
3	0.0	0.0	_mcConstantLine	FALSE	0.000	FALSE	0.0	0.0

The sample programming changes the curve shape for element 0 and adds a node point to element 1.

Element No.	Phase (Master Axis Phase)	Distance (Slave Axis Displacement)	Curve (Curve Shape)	Connecting-VelEnable (Connecting Velocity Enable)	ConnectingVel (Connecting Velocity)	ConnectingAccEnable (Connecting Acceleration Enable)	ConnectingAcc (Connecting Acceleration)	Phase-Pitch (Phase Pitch)
0	180.000	-100.000	<b>_mcPolynomial5</b>	FALSE	0.000	FALSE	0.000	0.010
1	<b>200.000</b>	<b>-102.000</b>	<b>_mcStraight-Line</b>	FALSE	0.000	FALSE	0.000	0.010
2	360.000	0.000	_mcPolynomial5	FALSE	0.000	FALSE	0.000	0.010
3	0.0	0.0	_mcConstantLine	FALSE	0.000	FALSE	0.0	0.0

## Ladder Diagram

### ● Main Variables

Name	Data type	Default	Comment
MC_Axis000	_sAXIS_REF	---	Axis Variable for the master axis, axis 1.
MC_Axis001	_sAXIS_REF	---	Axis Variable for the slave axis, axis 2.
CamProfile0	ARRAY[0..36000] OF _sMC_CAM_REF	---	This is the cam data variable. The cam data variable is created in advance on the Cam Editor of the Sysmac Studio.
Pwr1_Status	BOOL	---	This variable is assigned to the <i>Status</i> output variable from the PWR1 instance of the MC_Power instruction. This variable changes to TRUE when the Servo is turned ON.

Name	Data type	Default	Comment
Pwr2_Status	BOOL	---	This variable is assigned to the <i>Status</i> output variable from the PWR2 instance of the MC_Power instruction. This variable changes to TRUE when the Servo is turned ON.
StartPg	BOOL	---	The Servo is turned ON if this variable is TRUE and EtherCAT process data communications are established.
WriteCamDefinition	BOOL	---	The values in the cam property variable and cam node variable are written when this variable is TRUE.
CamProperty0	_sMC_CAM_PROPERTY	---	This is the cam property variable.
CamNode0	ARRAY[0..3] OF _sMC_CAM_NODE	---	This is the cam node variable.
_MC_COM.Status.GenerateCamBusy	BOOL	---	This is a system-defined variable for motion control. It is TRUE while the cam table creation is in progress.

● Timing Charts

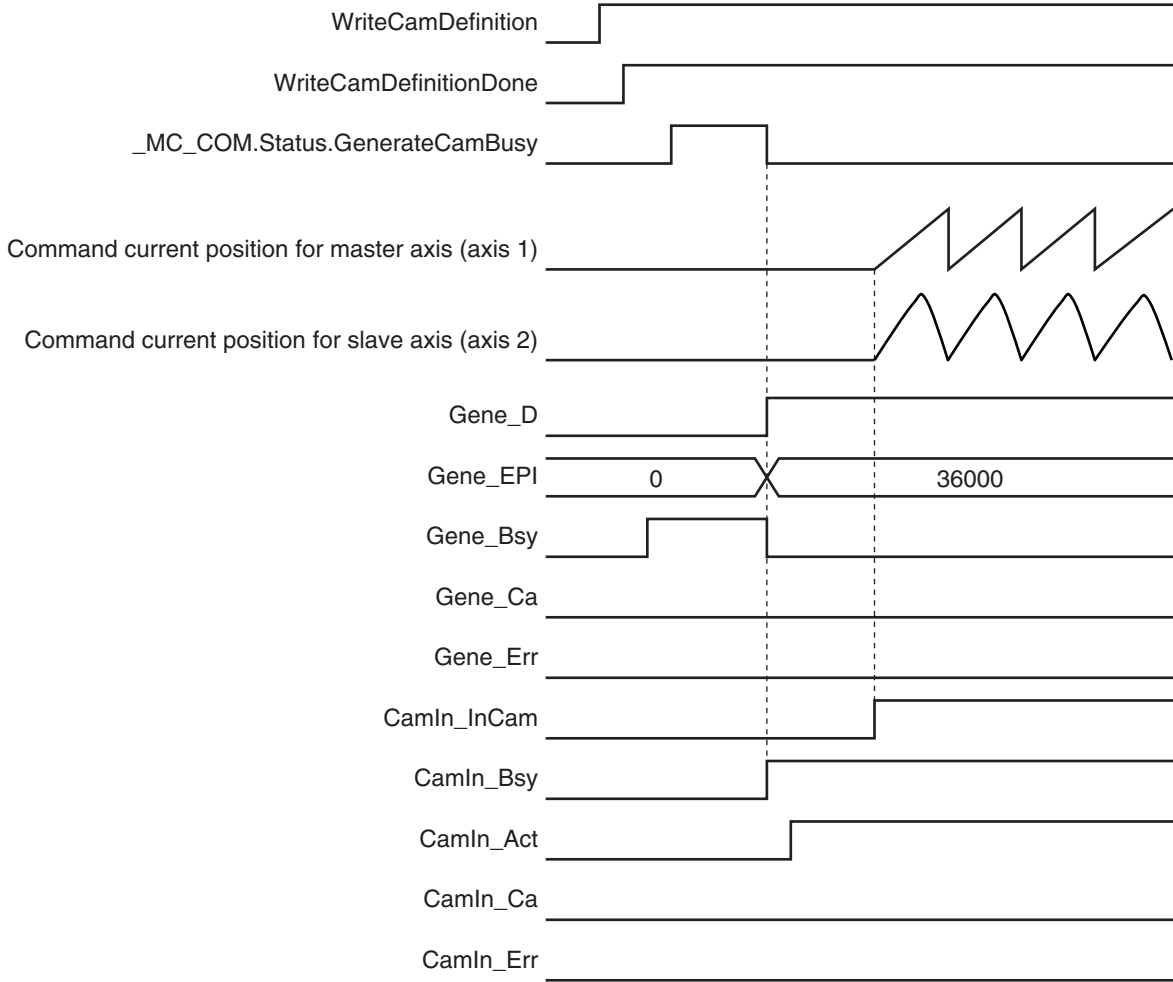

MC\_GenerateCamTable

5

Sample Programming

● Sample Programming

If StartPg is TRUE, check that the Servo Drives for each axis are ready.

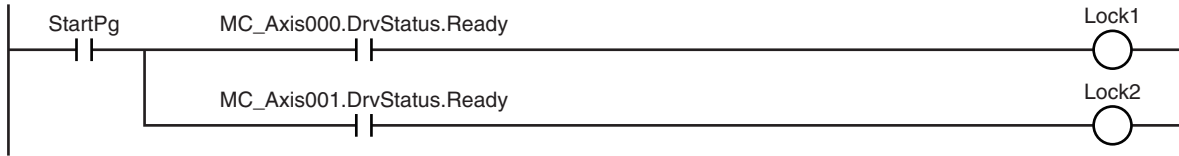

If the Servo Drives are ready, the Servos are turned ON for each axis.

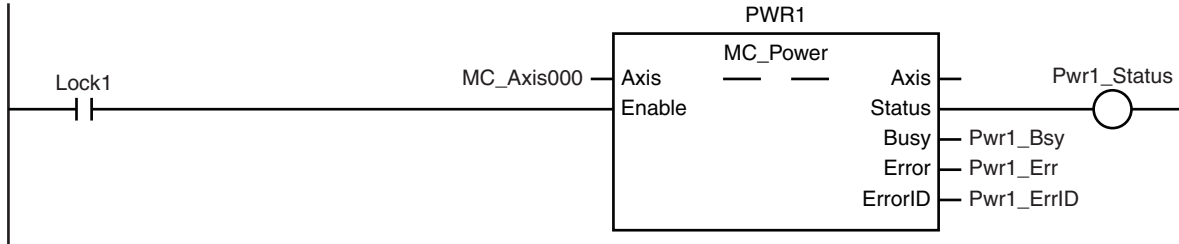

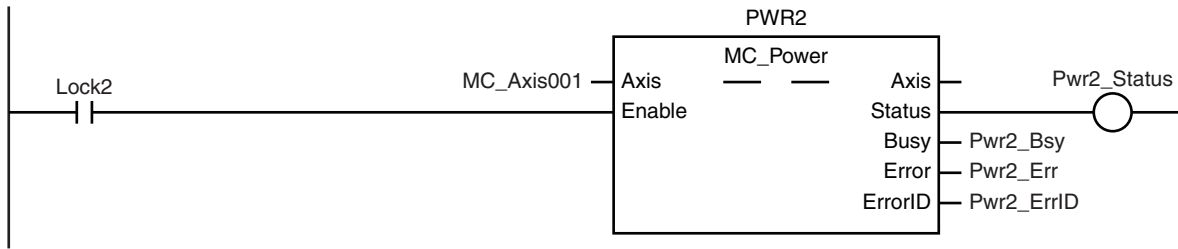

If a minor fault level error occurs in the MC Common Error Status variable or for any of the axes, the error handler for the device (FaultHandler) is executed. The FaultHandler is programmed according to the device.

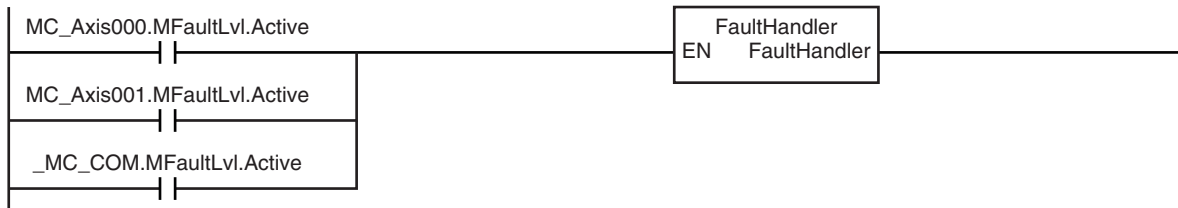

If the Servo is ON for the master axis (axis 1) and home is not defined, the Home instruction is executed to define home.

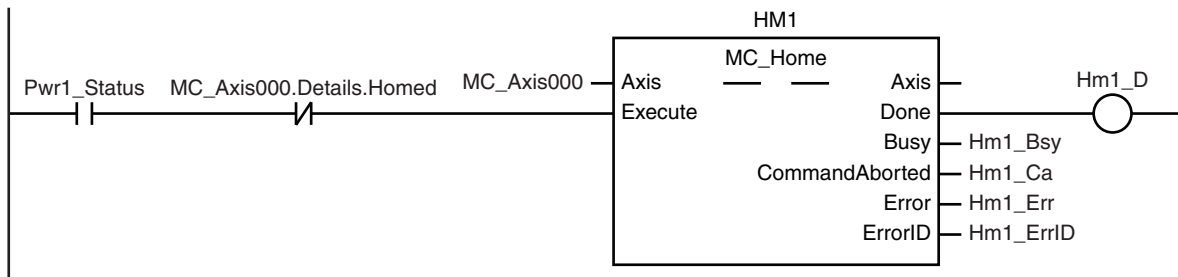

If the Servo is ON for the slave axis (axis 2) and home is not defined, the Home instruction is executed to define home.

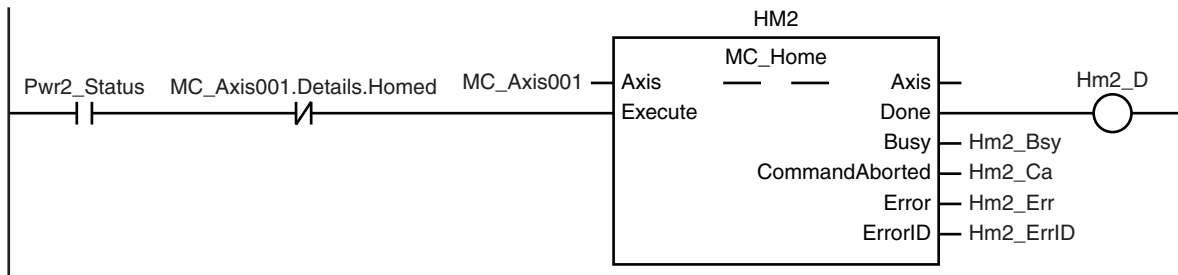

After homing is completed for the master axis (axis 1), the MC\_MoveVelocity (Velocity Control) instruction is executed.

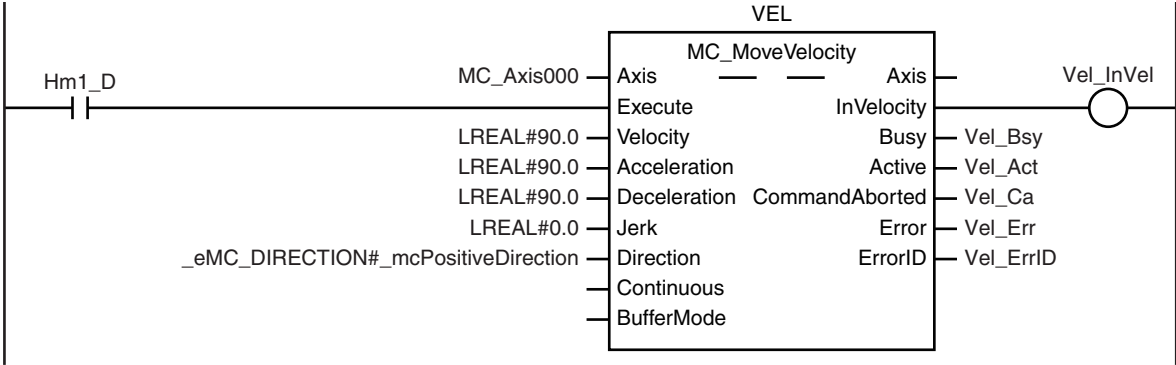

If *WriteCamDefinition* is TRUE and the MC\_GenerateCamTable (Generate Cam Table) instruction is not yet executed, the cam properties and cam nodes are written. After the data is written, *WriteCamDefinitionDone* is changed to TRUE.

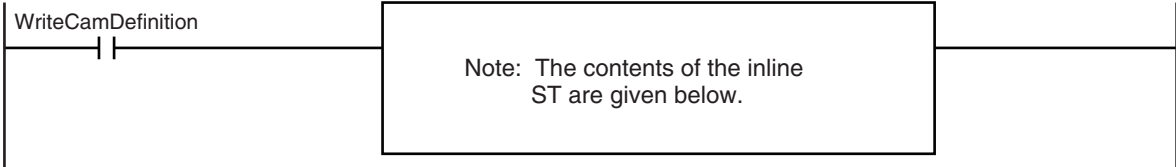

If *WriteCamDefinitionDone* is TRUE and cam table creation processing is not in progress, the MC\_GenerateCamTable (Generate Cam Table) instruction is executed.

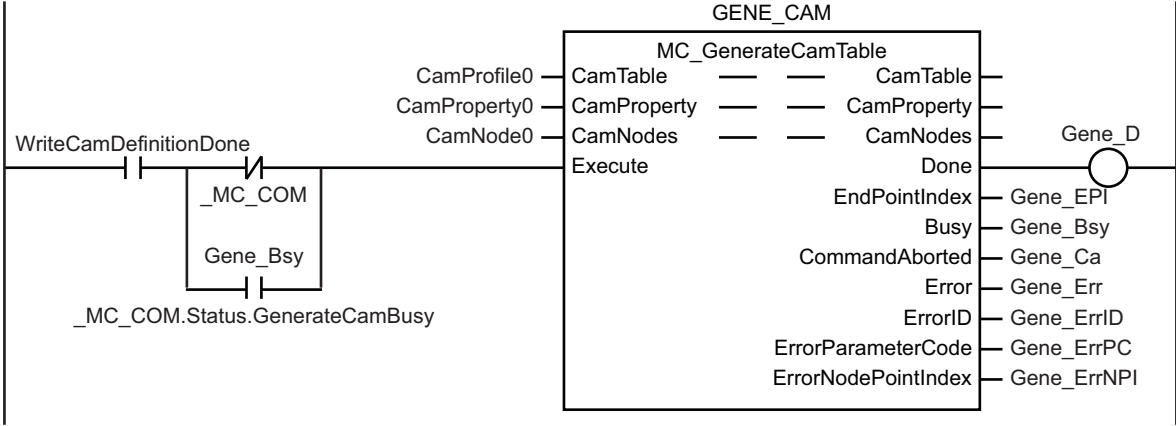

If cam table creation processing is completed and the master axis (axis 1) has reached the target velocity, the MC\_CamIn (Start Cam Operation) instruction is executed.

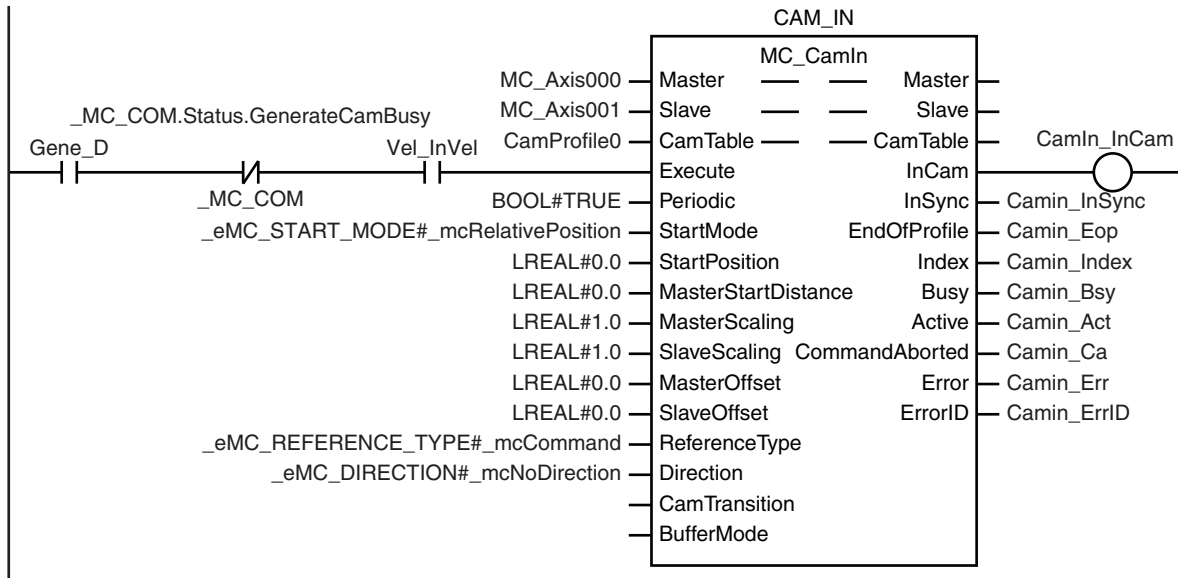

### Contents of Inline ST

```

CamProperty0.CycleTime := REAL#0.800;
CamNode0[0].Curve := _eMC_CAM_CURVE#_mcPolynomic5;
CamNode0[0].ConnectingVelEnable := FALSE;
CamNode0[0].ConnectingVel := REAL#0.000;
CamNode0[0].ConnectingAccEnable := FALSE;
CamNode0[0].ConnectingAcc := REAL#0.000;
CamNode0[1].Phase := REAL#200.000;
CamNode0[1].Distance := REAL#-102.000;
CamNode0[1].Curve := _eMC_CAM_CURVE#_mcStraightLine;
CamNode0[1].ConnectingVelEnable := FALSE;
CamNode0[1].ConnectingVel := REAL#0.000;
CamNode0[1].ConnectingAccEnable := FALSE;
CamNode0[1].ConnectingAcc := REAL#0.000;
CamNode0[2].Phase := REAL#360.000;
CamNode0[2].Distance := REAL#0.000;
CamNode0[2].Curve := _eMC_CAM_CURVE#_mcPolynomic5;
CamNode0[2].ConnectingVelEnable := FALSE;
CamNode0[2].ConnectingVel := REAL#0.000;
CamNode0[2].ConnectingAccEnable := FALSE;
CamNode0[2].ConnectingAcc := REAL#0.000;
CamNode0[2].PhasePitch := REAL#0.010;
CamNode0[3].Phase := REAL#0.000;
WriteCamDefinitionDone := TRUE;
    
```



## Structured Text (ST)

### ● Main Variables

Name	Data type	Default	Comment
MC_Axis000	_sAXIS_REF	---	Axis Variable for the master axis, axis 1.
MC_Axis001	_sAXIS_REF	---	Axis Variable for the slave axis, axis 2.
CamProfile0	ARRAY[0..36000] OF _sMC_CAM_REF	---	This is the cam data variable. The cam profile curve is created in advance on the Cam Editor of the Sysmac Studio.
Pwr1_Status	BOOL	---	This variable is assigned to the <i>Status</i> output variable from the PWR1 instance of the MC_Power instruction. This variable changes to TRUE when the Servo is turned ON.
Pwr2_Status	BOOL	---	This variable is assigned to the <i>Status</i> output variable from the PWR2 instance of the MC_Power instruction. This variable changes to TRUE when the Servo is turned ON.
StartPg	BOOL	---	The Servo is turned ON if this variable is TRUE and EtherCAT process data communications are established.
WriteCamDefinition	BOOL	---	The values in the cam property variable and cam node variable are written when this variable is TRUE.
CamProperty0	_sMC_CAM_PROP- ERTY	---	This is the cam property variable.
CamNode0	ARRAY[0..3] OF _sMC_CAM_NODE	---	This is the cam node variable.
_MC_COM.Status.GenerateCamBusy	BOOL	---	This is a system-defined variable for motion control. It is TRUE while the cam table creation is in progress.

## ● Timing Charts

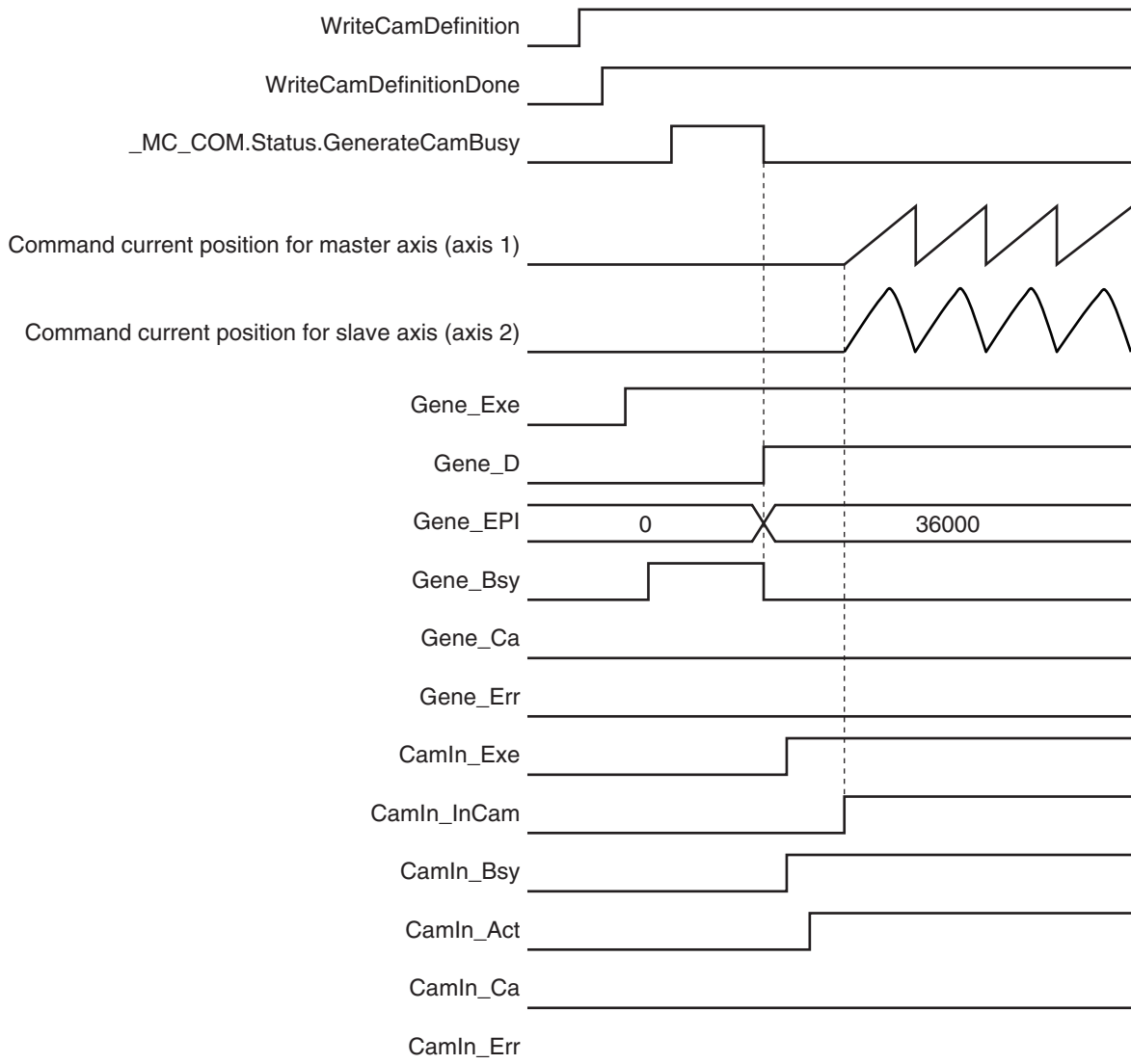

## ● Sample Programming

```

//If StartPg is TRUE and the Servo Drive is ready, the Servo for axis 1 is turned ON.
//If the Servo Drive is not ready, the Servo is turned OFF.
IF (StartPg=TRUE)
  AND (MC_Axis000.DrvStatus.Ready=TRUE) THEN
    Pwr1_En:=TRUE;
  ELSE
    Pwr1_En:=FALSE;
  END_IF;

//If StartPg is TRUE and the Servo Drive is ready, the Servo for axis 2 is turned ON.
//If the Servo Drive is not ready, the Servo is turned OFF.
IF (StartPg=TRUE)
  AND (MC_Axis001.DrvStatus.Ready=TRUE) THEN

```

```

    Pwr2_En:=TRUE;
ELSE
    Pwr2_En:=FALSE;
END_IF;

//If a minor fault level error occurs in the MC Common Error Status variable or for
any of the axes, the error handler for the device (FaultHandler) is executed.
//The FaultHandler is programmed according to the device.
IF (MC_Axis000.MFaultLvl.Active=TRUE)
OR (MC_Axis001.MFaultLvl.Active=TRUE)
OR (_MC_COM.MFaultLvl.Active=TRUE) THEN
    FaultHandler();
END_IF;

//If the Servo is ON for axis 1 and home is not defined, the Home instruction is ex
ecuted.
IF (Pwr1_Status=TRUE) AND (MC_Axis000.Details.Homed=FALSE) THEN
    Hm1_Ex:=TRUE;
END_IF;

//If the Servo is ON for axis 2 and home is not defined, the Home instruction is ex
ecuted.
IF (Pwr2_Status=TRUE) AND (MC_Axis001.Details.Homed=FALSE) THEN
    Hm2_Ex:=TRUE;
END_IF;

//After homing is completed for axis 1, the MC_MoveVelocity instruction is executed
.
IF Hm1_D=TRUE THEN
    Vel_Ex := TRUE;
END_IF;

//If WriteCamDefinition is TRUE and the MC_GenerateCamTable (Generate Cam Table) in
struction is not yet executed, the cam properties and cam nodes are written.
//After the data is written, WriteCamDefinitionDone is changed to TRUE.
IF(WriteCamDefinition = TRUE) THEN
    //The cam properties are written.
    CamProperty0.CycleTime := REAL#0.800;

    //The cam nodes are written.
    CamNode0[0].Curve :=_eMC_CAM_CURVE#_mcPolynomic5;
    CamNode0[0].ConnectingVelEnable := FALSE;
    CamNode0[0].ConnectingVel := REAL#0.000;
    CamNode0[0].ConnectingAccEnable := FALSE;
    CamNode0[0].ConnectingAcc := REAL#0.000;
    CamNode0[1].Phase := REAL#200.000;
    CamNode0[1].Distance := REAL#-102.000;

```

```

CamNode0[1].Curve := _eMC_CAM_CURVE#_mcStraightLine;
CamNode0[1].ConnectingVelEnable := FALSE;
CamNode0[1].ConnectingVel := REAL#0.000;
CamNode0[1].ConnectingAccEnable := FALSE;
CamNode0[1].ConnectingAcc := REAL#0.000;
CamNode0[2].Phase := REAL#360.000;
CamNode0[2].Distance := REAL#0.000;
CamNode0[2].Curve := _eMC_CAM_CURVE#_mcPolynomic5;
CamNode0[2].ConnectingVelEnable := FALSE;
CamNode0[2].ConnectingVel := REAL#0.000;
CamNode0[2].ConnectingAccEnable := FALSE;
CamNode0[2].ConnectingAcc := REAL#0.000;
CamNode0[2].PhasePitch := REAL#0.010;
CamNode0[3].Phase := REAL#0.000;

//WriteCamDefinitionDone is changed to TRUE.
WriteCamDefinitionDone := TRUE;
END_IF;

//If WriteCamDefinitionDone is TRUE and cam table creation processing is not in progress, the MC_GenerateCamTable (Generate Cam Table) instruction is executed.
IF(WriteCamDefinitionDone = TRUE)
AND(_MC_COM.Status.GenerateCamBusy = FALSE) THEN
    Gene_Exe := TRUE;
END_IF;

//If cam table creation processing is completed and the master axis (axis 1) has reached the target velocity, the MC_CamIn (Start Cam Operation) instruction is executed.
IF (Gene_D=TRUE)
AND(_MC_COM.Status.GenerateCamBusy = FALSE)
AND (Vel_InVel=TRUE) THEN
    Camin_Ex := TRUE;
END_IF;

// MC_GenerateCamTable
GENE_CAM(
    CamTable := CamProfile0,
    CamProperty := CamProperty0,
    CamNodes := CamNode0,
    execute := Gene_Exe,
    Done => Gene_D,
    EndPointIndex => Gene_EPI,
    Busy => Gene_Bsy,
    CommandAborted => Gene_CA,
    Error => Gene_Err,
    ErrorID => Gene_ErrID,

```

```

    ErrorParameterCode => Gene_ErrPC,
    ErrorNodePointIndex => Gene_ErrNPI
);

// MC_Power for master axis (axis 1)
PWR1(
    Axis := MC_Axis000,
    Enable := Pwr1_En,
    Status => Pwr1_Status,
    Busy => Pwr1_Bsy,
    Error => Pwr1_Err,
    ErrorID => Pwr1_ErrID
);

// MC_Power for slave axis (axis 2)
PWR2(
    Axis := MC_Axis001,
    Enable := Pwr2_En,
    Status => Pwr2_Status,
    Busy => Pwr2_Bsy,
    Error => Pwr2_Err,
    ErrorID => Pwr2_ErrID
);

// MC_Home for master axis (axis 1)
HM1(
    Axis := MC_Axis000,
    Execute := Hm1_Ex,
    Done => Hm1_D,
    Busy => Hm1_Bsy,
    CommandAborted => Hm1_Ca,
    Error => Hm1_Err,
    ErrorID => Hm1_ErrID
);

// MC_Home for slave axis (axis 2)
HM2(
    Axis := MC_Axis001,
    Execute := Hm2_Ex,
    Done => Hm2_D,
    Busy => Hm2_Bsy,
    CommandAborted => Hm2_Ca,
    Error => Hm2_Err,
    ErrorID => Hm2_ErrID
);

//MC_MoveVelocity

```

```

VEL(
    Axis := MC_Axis000,
    Execute := Vel_Ex,
    Velocity := Vel_Vel,
    Acceleration := Vel_Acc,
    Deceleration := Vel_Dec,
    Direction := Vel_Dir,
    InVelocity => Vel_InVel,
    Busy => Vel_Bsy,
    Active => Vel_Act,
    CommandAborted => Vel_Ca,
    Error => Vel_Err,
    ErrorID => Vel_ErrID
);

//MC_CamIn
CAM_IN(
    Master := MC_Axis000,
    Slave := MC_Axis001,
    CamTable := CamProfile0,
    Execute := Camin_Ex,
    Periodic := Camin_P,
    StartMode := Camin_Sm,
    StartPosition := Camin_Sp,
    MasterStartDistance := Camin_Msd,
    MasterScaling := Camin_Ms,
    SlaveScaling := Camin_Ss,
    MasterOffset := Camin_Mo,
    SlaveOffset := Camin_So,
    ReferenceType := Camin_Rt,
    Direction := Camin_Dir,
    InCam => Camin_InCam,
    InSync => Camin_InSync,
    EndOfProfile => Camin_Eop,
    Index => Camin_Index,
    Busy => Camin_Bsy,
    Active => Camin_Act,
    CommandAborted => Camin_Ca,
    Error => Camin_Err,
    ErrorID => Camin_ErrID
);

```

# MC\_WriteAxisParameter

The MC\_WriteAxisParameter instruction writes axis parameters in the MC Function Module.

Instruction	Name	FB/ FUN	Graphic expression	ST expression
MC_WriteAxis- Parameter	Write Axis Parameters	FB		<pre>MC_WriteAxisParameter_instance (   Axis :=parameter,   AxisParameter :=parameter,   Execute :=parameter,   Done =&gt;parameter,   Busy =&gt;parameter,   CommandAborted =&gt;parameter,   Error =&gt;parameter,   ErrorID =&gt;parameter,   ErrorParameterCode =&gt;parameter, );</pre>



## Version Information

A CPU Unit with unit version 1.08 or later and Sysmac Studio version 1.09 or higher are required to use this instruction.

## Variables

### Input Variables

Name	Meaning	Data type	Valid range	Default	Description
Execute	Execute	BOOL	TRUE or FALSE	FALSE	The instruction is executed when the value of this variable changes to TRUE.

### Output Variables

Name	Meaning	Data type	Valid range	Description
Done	Done	BOOL	TRUE or FALSE	TRUE when the instruction is completed.
Busy	Executing	BOOL	TRUE or FALSE	TRUE when the instruction is acknowledged.
CommandAborted	Command Aborted	BOOL	TRUE or FALSE	TRUE when the instruction is aborted.
Error	Error	BOOL	TRUE or FALSE	TRUE while there is an error.
ErrorID	Error Code	WORD	*1	Contains the error code when an error occurs. A value of 16#0000 indicates normal execution.

Name	Meaning	Data type	Valid range	Description
ErrorParameterCode	Parameter Detail Code	WORD	*1	Contains the attached information for some error codes. If the information is saved, the detail code of the parameter for which the error occurred is output.

\*1. The upper four digits of the event code give the error code for ErrorID. Refer to the *NJ/NX-series Troubleshooting Manual (Cat. No. W503)* for the event codes.

## ● Output Variable Update Timing

Name	Timing for changing to TRUE	Timing for changing to FALSE
Done	When the instruction is completed.	<ul style="list-style-type: none"> <li>When <i>Execute</i> is TRUE and changes to FALSE.</li> <li>After one period when <i>Execute</i> is FALSE.</li> </ul>
Busy	When <i>Execute</i> changes to TRUE.	<ul style="list-style-type: none"> <li>When <i>Done</i> changes to TRUE.</li> <li>When <i>Error</i> changes to TRUE.</li> <li>When <i>CommandAborted</i> changes to TRUE.</li> </ul>
CommandAborted	When this instruction is canceled due to an error.	<ul style="list-style-type: none"> <li>When <i>Execute</i> is TRUE and changes to FALSE.</li> <li>After one period when <i>Execute</i> is FALSE.</li> </ul>
Error	When there is an error in the execution conditions or input parameters for the instruction.	When the error is cleared.

## In-Out Variables

Name	Meaning	Data type	Valid range	Description
Axis	Axis	_sAXIS_REF	---	Specify the axis for which to write the parameters. *1
AxisParameter	Axis Parameters	_sAXIS_PARAM	---	Specify the values to write. *2

\*1. Specify a user-defined Axis Variable that was created in the Axis Basic Settings of the Sysmac Studio (default: MC\_Axis\*) or a system-defined axis variable name (\_MC\_AX[\*], \_MC1\_AX[\*], or \_MC2\_AX[\*]).

If you use Sysmac Studio version 1.29 or higher, you can specify the system-defined axis variable name for AT specification of a user-defined variable. This will allow you to specify the user-defined variable.

If you use Sysmac Studio version 1.28 or lower, do not specify any user-defined variable created in the variable table.

\*2. Define a user-defined variable with a data type of \_sAXIS\_PARAM.

## Function

- When *Execute* changes to TRUE, the MC\_WriteAxisParameter instruction writes the values specified in *AxisParameter* (Axis Parameters) to the axis parameters for the axis specified with *Axis*.
- You can write data only when the specified axis is an unused axis. If the instruction is executed for any other condition, an execution error occurs and the axis parameters are not written. The values before the instruction was executed will be held.
- If you execute this instruction after you change axis usage with the MC\_ChangeAxisUse instruction, make sure that the *Done* output variable from the MC\_ChangeAxisUse instruction is TRUE before you execute this instruction.



- If there is an illegal value in *AxisParameter* (Axis Parameters) or if there is an inconsistency within the axis parameters, an execution error occurs and the axis parameters are not written. The values before the instruction was executed will be held.

For information on the setting ranges of the axis parameters or the consistency check within the axis parameters, refer to the *NJ/NX-series CPU Unit Motion Control User's Manual (Cat. No. W507)*.



### Precautions for Correct Use

- The values that are written by this instruction are not saved in non-volatile memory in the CPU Unit. Any values that are written are lost when the power supply to the CPU Unit is turned OFF, when settings are downloaded, or when the MC Function Module is restarted. They return to the values that were set from the Sysmac Studio.
- You cannot upload the values that are written with this instruction to the Sysmac Studio.
- You must set all of the axis parameters for the axis that you are writing, not just the axis parameters that you want to change with this instruction. Refer to *Axis Parameters That Are Written and Read* on page 5-60 for the applicable parameters. For axis parameters that do not need to be changed, set the same values as those that were set from the Sysmac Studio or the values that are read by the MC\_ReadAxisParameter (Read Axis Parameters) instruction.
- An illustration of combining this instruction with the MC\_ReadAxisParameter (Read Axis Parameters) instruction is provided below.

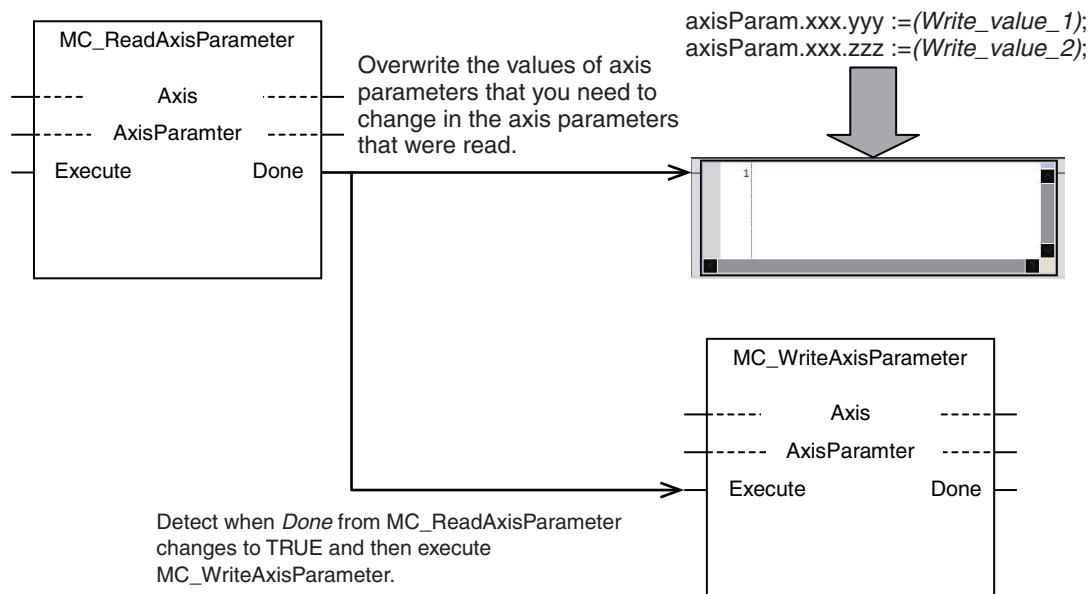

- An example that uses this instruction with the MC\_ChangeAxisUse (Change Axis Use) instruction is given. Execute this instruction only after confirming that *Done* from the MC\_ChangeAxisUse (Change Axis Use) instruction changes to TRUE.

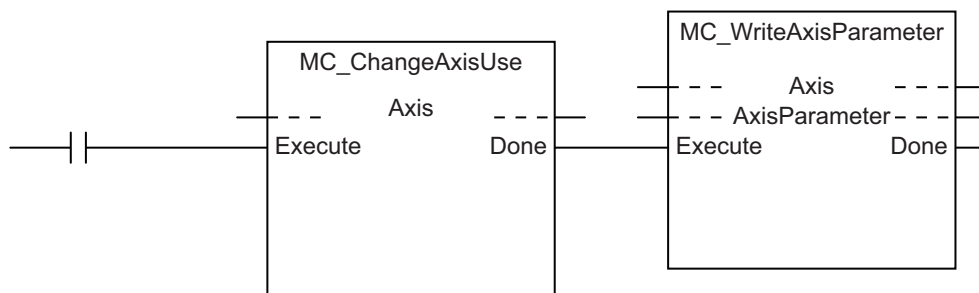

- If you use this instruction to change the **Unit Conversion Settings** or **Position Count Settings** for an axis whose encoder type is set to **Absolute encoder (ABS)**, the relationship between the physical position of the machine and the axis position in the MC Function Module will change. In this case, use the MC\_ChangeAxisUse (Change Axis Use) instruction to change the axis to an used axis, and then execute the Home instruction to define the home again.
- If an Absolute Encoder Current Position Calculation Failed (error code: 6458 hex) occurred after the axis was changed to an used axis, clear the axis error and then execute the Home instruction to define the home again.

- Do not set the reserved parameters in the axis parameters to any value other than 0.

## Instruction Details

This section describes the instruction in detail.

### ● **\_sAXIS\_PARAM**

The `_sAXIS_PARAM` data type is used to specify the values of axis parameter. The axis parameters are configured in members with a structure data type for each type of axis parameters.

This data type is used for the variable that is specified for the *AxisParameter* (Axis Parameters) in-out variable.

Each member is described in the following table.

Member	Parameter name	Data type	Description
UnitConversion	Unit Conversion Settings	<code>_sAXIS_UNIT_CONVERSION_SETTINGS</code>	Specify the values to write for the member variables for the unit conversion settings.
Operation	Operation Settings	<code>_sAXIS_OPERATION_SETTINGS</code>	Specify the values to write for the member variables for the operation settings.
OtherOperation	Other Operation Settings	<code>_sAXIS_OTHER_OPERATION_SETTINGS</code>	Specify the values to write for the member variables for the other operation settings.
Limit	Limit Settings	<code>_sAXIS_LIMIT_SETTINGS</code>	Specify the values to write for the member variables for the limit settings.
PosCount	Position Count Settings	<code>_sAXIS_POSITION_COUNT_SETTINGS</code>	Specify the values to write for the member variables for the position count settings.
Homing	Homing Settings	<code>_sAXIS_HOMING_SETTINGS</code>	Specify the values to write for the member variables for the homing settings.
(Reserved)	(Reserved area)	ARRAY[0..255] OF BYTE	---

### ● **\_sAXIS\_UNIT\_CONVERSION\_SETTINGS (Unit Conversion Settings)**

The `_sAXIS_UNIT_CONVERSION_SETTINGS` structure data type is used to specify the values of the unit conversion settings in the axis parameters.

Each member is described in the following table.

Member	Parameter name	Data type	Valid range	Description
UnitDisplay	Unit of Display	<code>_eMC_UNIT</code>	0: <code>_mcPls</code> 1: <code>_mcMm</code> 2: <code>_mcUm</code> 3: <code>_mcNm</code> 4: <code>_mcDeg</code> 5: <code>_mcInch</code>	Sets the unit for command positions. 0: pulse 1: mm 2: $\mu$ m 3: nm 4: degree 5: inch

Member	Parameter name	Data type	Valid range	Description
CmdPlsCountPerMotorRotation	Command Pulse Count Per Motor Rotation	UDINT	1 to 4,294,967,295	Set the number of pulses per motor rotation for command positions according to the encoder resolution. The command value is converted to the equivalent number of pulses based on the electronic gear ratio.
WorkTravelDistancePerMotorRotation	Work Travel Distance Per Motor Rotation	LREAL	0.000000001 to 4,294,967,295	Set the workpiece travel distance per motor rotation for command positions.
ReducerUse *1	Reducer Use	BOOL	TRUE or FALSE	Specify whether to use the reducer setting or not. TRUE: Use. FALSE: Do not use.
WorkTravelDistancePerWorkSideRotation *1 *2 *3	Work Travel Distance Per Rotation	LREAL	Positive long reals	Set the work travel distance per rotation.
WorkSideGearRatio *1 *2	Work Gear Ratio	UDINT	1 to 4,294,967,295	Set the gear ratio for the workpiece.
MotorSideGearRatio *1 *2	Motor Gear Ratio	UDINT	1 to 4,294,967,295	Set the gear ratio of the motor.
(Reserved)	(Reserved area)	ARRAY [0..7] OF BYTE *4	---	---

- \*1. A CPU Unit with unit version 1.11 or later and Sysmac Studio version 1.15 or higher are required to use this parameter.
- \*2. This parameter is enabled when you set **Reducer Use** to TRUE.
- \*3. The setting is possible only when the Count Mode is **Linear Mode**. When the Count Mode is **Rotary Mode**, the parameter value is calculated from the modulo maximum position setting value and modulo minimum position setting value.
- \*4. For a CPU Unit with unit version 1.10 earlier, the data type is ARRAY [0..31] OF BYTE.

### ● **\_s\_AXIS\_OPERATION\_SETTINGS (Operation Settings)**

The **\_s\_AXIS\_OPERATION\_SETTINGS** structure data type is used to specify the values of axis parameter operation settings.

Each member is described in the following table.

Member	Parameter name	Data type	Valid range	Description
MaxVel	Maximum Velocity	LREAL	Positive long reals	Set the maximum velocity for each axis. Do not set a value that exceeds the maximum speed of the motor that you are using.
StartVel	Start Velocity	LREAL	0.0 to Upper limit of positive long reals	Set the start velocity for the axis. Set a value that does not exceed the maximum velocity.
MaxJogVel	Maximum Jog Velocity	LREAL	Positive long reals	Set the maximum jog velocity for the axis. Set a value that does not exceed the maximum velocity.

Member	Parameter name	Data type	Valid range	Description
MaxAcc	Maximum Acceleration	LREAL	Non-negative long reals	Set the maximum acceleration rate for an axis operation command. There will be no limit to the acceleration rate if 0 is set.
MaxDec	Maximum Deceleration	LREAL	Non-negative long reals	Set the maximum deceleration rate for an axis operation command. There will be no limit to the deceleration rate if 0 is set.
AccDecOver	Acceleration/Deceleration Over	_eMC_AC-CDECOVER	0: _mcAccDecOverBuffer 1: _mcAccDecOverRapid 2: _mcAccDecOverError-Stop	Set the operation for when the maximum acceleration/deceleration rate would be exceeded after excessive acceleration/deceleration during acceleration/deceleration control of the axis because stopping at the target position is given priority. 0: Use rapid acceleration/deceleration. (Blending is changed to Buffered.)* <sup>1</sup> 1: Use rapid acceleration/deceleration. 2: Minor fault stop* <sup>2</sup>
ReverseMode	Operation Selection at Reversing	_eMC_REVERSE_MODE	0: _mcReverseModeDecelerationStop 1: _mcReverseModeImmediateStop	Specify the operation for reversing rotation for multi-execution of instructions, re-execution of instructions, and interrupt feeding. 0: Deceleration stop 1: Immediate stop
VelWarningVal	Velocity Warning Value	UINT	0 or 1 to 100	Set the percentage of the maximum velocity at which to output a velocity warning for the axis. No velocity warning is output if 0 is set.
AccWarningVal	Acceleration Warning Value	UINT	0 or 1 to 100	Set the percentage of the maximum acceleration rate at which to output an acceleration warning for the axis. No acceleration warning is output if 0 is set.
DecWarningVal	Deceleration Warning Value	UINT	0 or 1 to 100	Set the percentage of the maximum deceleration rate at which to output a deceleration warning for the axis. No deceleration warning is output if 0 is set.
PosiTrqWarningVal* <sup>3</sup>	Positive Torque Warning Value	UINT	0 or 1 to 1,000	Set the torque command value at which to output a positive torque warning. No positive torque warning is output if 0 is set.
NegaTrqWarningVal* <sup>3</sup>	Negative Torque Warning Value	UINT	0 or 1 to 1,000	Set the torque command value at which to output a negative torque warning. No negative torque warning is output if 0 is set.

Member	Parameter name	Data type	Valid range	Description
InPosRange	In-position Range	LREAL	Non-negative long reals	Set the in-position width.
InPosCheckTime	In-position Check Time	UINT	0 or 1 to 10,000	Set the in-position check time in milliseconds. Set 0 to check for the end of positioning only when you define the home position during homing. No check is made for the end of positioning at other times.
ActVelFilterTime-Constant	Actual Velocity Filter Time Constant	UINT	0 or 1 to 100	Set the time period to calculate the average travel of the actual velocity in milliseconds. The average travel is not calculated if 0 is set.
ZeroPosRange	Zero Position Range	LREAL	Non-negative long reals	Set the home position detection width.
(Reserved)	(Reserved area)	ARRAY[0..31] OF BYTE	---	---

- \*1. For a CPU Unit with unit version 1.10 or later, **Blending** is not changed to **Buffered**.  
For details, refer to the *NJ/NX-series CPU Unit Motion Control User's Manual (Cat. No. W507)*.
- \*2. For a CPU Unit with unit version 1.10 or later, the axis does not stop with an error and operation continues if blending operation is used.  
For details, refer to the *NJ/NX-series CPU Unit Motion Control User's Manual (Cat. No. W507)*.
- \*3. This parameter is enabled only for torque control.

### ● **\_sAXIS\_OTHER\_OPERATION\_SETTINGS (Other Operation Settings)**

The `_sAXIS_OTHER_OPERATION_SETTINGS` structure data type is used to specify the values of other axis parameter operation settings.

Each member is described in the following table.

Member	Parameter name	Data type	Valid range	Description
ImmediateStopInputStopMode	Immediate Stop Input Stop Method	_eMC_STOP_MODE	1: _mcImmediateStop 2: _mcImmediateStopFEReset 3: _mcFreeRunStop	Set the stopping method in the MC Function Module when the immediate stop input is enabled. 1: Immediate stop 2: Immediate stop and error reset 3: Immediate stop and Servo OFF
LimitInputStopMode	Limit Input Stop Method	_eMC_STOP_MODE	0: _mcDecelerationStop 1: _mcImmediateStop 2: _mcImmediateStopFEReset 3: _mcFreeRunStop	Set the stopping method in the MC Function Module when the positive limit input or negative limit input is enabled. 0: Deceleration stop 1: Immediate stop 2: Immediate stop and error reset 3: Immediate stop and Servo OFF
DriveErrorResetMonitoringTime	Drive Error Reset Monitoring Time	UINT	1 to 1,000	Set the monitor time for a drive error reset. (Unit: ms) After the monitor time has elapsed, reset processing will end even if the drive error is not yet reset.

Member	Parameter name	Data type	Valid range	Description
MaxPosiTrqLimit	Maximum Positive Torque Limit	LREAL	0.0 to 1,000.0	Set the maximum value of the positive torque limit.
MaxNegaTrqLimit	Maximum Negative Torque Limit	LREAL	0.0 to 1,000.0	Set the maximum value of the negative torque limit.
ImmediateStopInputLogicInversion	Immediate Stop Input Logic Inversion	BOOL	TRUE or FALSE	Set whether to reverse the logic of the immediate stop input signal. TRUE: Reverse turn. FALSE: No reverse turn.
PosiLimitInputLogicInversion	Positive Limit Input Logic Inversion	BOOL	TRUE or FALSE	Set whether to reverse the logic of the positive limit input signal. TRUE: Reverse turn. FALSE: No reverse turn.
NegaLimitInputLogicInversion	Negative Limit Input Logic Inversion	BOOL	TRUE or FALSE	Set whether to reverse the logic of the negative limit input signal. TRUE: Reverse turn. FALSE: No reverse turn.
HomeProximityInputLogicInversion	Home Proximity Input Logic Inversion	BOOL	TRUE or FALSE	Set whether to reverse the logic of the home proximity input signal. TRUE: Reverse turn. FALSE: No reverse turn.
(Reserved)	(Reserved area)	ARRAY[0..31] OF BYTE	---	---

### ● **\_sAXIS\_LIMIT\_SETTINGS (Limit Settings)**

The `_sAXIS_LIMIT_SETTINGS` structure data type is used to specify the values of the limit settings in the axis parameters.

Each member is described in the following table.

Member	Parameter name	Data type	Valid range	Description
SwLimitMode	Software Limits	<code>_eMC_SW_LMT_MODE</code>	0: <code>_mcNonSwLmt</code> 1: <code>_mcCmdDecelerationStop</code> 2: <code>_mcCmdImmediateStop</code> 3: <code>_mcActDecelerationStop</code> 4: <code>_mcActImmediateStop</code>	Select the software limit function. 0: Disabled 1: Deceleration stop for command position 2: Immediate stop for command position 3: Deceleration stop for actual position 4: Immediate stop for actual position
PosiSwLimit	Positive Software Limit	LREAL	Long reals	Set the software limit in the positive direction.
NegaSwLimit	Negative Software Limit	LREAL	Long reals	Set the software limit in the negative direction.
FollowingErrorOverVal	Following Error Over Value	LREAL	Non-negative long reals	Set the excessive following error check value. Set 0 to disable the excessive following error check.

Member	Parameter name	Data type	Valid range	Description
FollowingError-WarningVal	Following Error Warning Value	LREAL	Non-negative long reals	Set the following error warning check value. Set 0 to disable the following error warning check.
(Reserved)	(Reserved area)	AR-RAY[0..31] OF BYTE	---	---

### ● **\_s\_AXIS\_POSITION\_COUNT\_SETTINGS (Position Count Settings)**

The `_s_AXIS_POSITION_COUNT_SETTINGS` structure data type is used to specify the values of the position count settings in the axis parameters.

Each member is described in the following table.

Member	Parameter name	Data type	Valid range	Description
CountMode	Count Mode	<code>_eMC_COUNT_MODE</code>	0: <code>_mcCountModeLinear</code> 1: <code>_mcCountModeRotary</code>	Set the count mode for the position. 0: Linear Mode (finite length) 1: Rotary Mode (infinite length)
ModuloMax-PosVal	Modulo Maximum Position Setting Value	LREAL	Long reals	Set the modulo maximum position when the Count Mode is set to <b>Rotary Mode</b> .
ModuloMin-PosVal	Modulo Minimum Position Setting Value	LREAL	Long reals	Set the modulo minimum position when the Count Mode is set to <b>Rotary Mode</b> .
(Reserved)	(Reserved area)	AR-RAY[0..31] OF BYTE	---	---

### ● **\_s\_AXIS\_HOMING\_SETTINGS (Homing Settings)**

The `_s_AXIS_HOMING_SETTINGS` structure data type is used to specify the values of the homing settings in the axis parameters.

Each member is described in the following table.

Member	Parameter name	Data type	Valid range	Description
Mode	Homing Method	<code>_eMC_HOMING_MODE</code>	0: <code>_mcHomeSwTurnHomeSwOff</code> 1: <code>_mcHomeSwTurnHomeSwOn</code> 4: <code>_mcHomeSwOff</code> 5: <code>_mcHomeSwOn</code> 8: <code>_mcLimitInputOff</code> 9: <code>_mcHomeSwTurnHomeMask</code> 11: <code>_mcLimitInputOnly</code> 12: <code>_mcHomeSwTurnHoldingTime</code> 13: <code>_mcNoHomeSwHoldingHomeInput</code> 14: <code>_mcHomePreset</code>	Set the homing operation. 0: Proximity reverse turn/home proximity input OFF 1: Proximity reverse turn/home proximity input ON 4: Home proximity input OFF 5: Home proximity input ON 8: Limit input OFF 9: Proximity reverse turn/home input mask distance 11: Limit inputs only 12: Proximity reverse turn/holding time 13: No home proximity input/holding home input 14: Zero position preset



Member	Parameter name	Data type	Valid range	Description
HomeInputSignal	Home Input Signal	_eMC_HOME_INPUT	0: _mcZPhase 1: _mcExternalSignal	Select the input to use for the home input signal. 0: Use Z-phase input as home 1: Use external home input
StartDirection	Homing Start Direction	_eMC_DIRECTION	0: _mcPositiveDirection 2: _mcNegativeDirection	Set the start direction for when homing is started. 0: Positive direction 2: Negative direction
HomeInputDetectionDirection	Home Input Detection Direction	_eMC_DIRECTION	0: _mcPositiveDirection 2: _mcNegativeDirection	Set the home input detection direction for homing. 0: Positive direction 2: Negative direction
PosiLimitInputMode	Operation Selection at Positive Limit Input	_eMC_LIMIT_REVERSE_MODE	0: _mcErrorStop 1: _mcRevImmediateStop 2: _mcRevDecelerationStop	Set the stopping method when the positive limit input turns ON during homing. 0: No reverse turn/minor fault stop (Stop according to Limit Input Stop Method parameter.) 1: Reverse turn/immediate stop 2: Reverse turn/deceleration stop
NegaLimitInputMode	Operation Selection at Negative Limit Input	_eMC_LIMIT_REVERSE_MODE	0: _mcErrorStop 1: _mcRevImmediateStop 2: _mcRevDecelerationStop	Set the stopping method when the negative limit input turns ON during homing. 0: No reverse turn/minor fault stop (Stop according to Limit Input Stop Method parameter.) 1: Reverse turn/immediate stop 2: Reverse turn/deceleration stop
Vel	Homing Velocity	LREAL	Positive long reals	Set the homing velocity.
ApproachVel	Homing Approach Velocity	LREAL	Positive long reals	Set the velocity to use after the home proximity input turns ON.
Acc	Homing Acceleration	LREAL	Non-negative long reals	Set the acceleration rate for homing. If the homing acceleration is set to 0, the homing velocity or other target velocity is used without any acceleration.
Dec	Homing Deceleration	LREAL	Non-negative long reals	Set the deceleration rate for homing. If the homing deceleration is set to 0, the homing approach velocity or other target velocity is used without any deceleration.
Jerk	Homing Jerk	LREAL	Non-negative long reals	Set the jerk for homing. Set 0 for no jerk.
HomeInputMaskDistance	Home Input Mask Distance	LREAL	Non-negative long reals	Set the home input mask distance when you set the Homing Operation Mode to the proximity reverse turn/home input mask distance.
HomeOffset	Home Offset	LREAL	Long reals	Preset the actual position for the value that is set after homing.

Member	Parameter name	Data type	Valid range	Description
HoldingTime	Homing Holding Time	UINT	0 to 10,000	Set the holding time in milliseconds when you set the Homing Operation Mode to the proximity reverse turn/ holding time.
CompensationVal	Homing Compensation Value	LREAL	Long reals	Set the homing compensation value that is applied after the home is defined.
CompensationVel	Homing Compensation Velocity	LREAL	Positive long reals	Set the velocity to use for homing compensation.
(Reserved)	(Reserved area)	AR-RAY[0..31] OF BYTE	---	---

## Axis Parameters That Are Written and Read

The axis parameters that you can write with this instruction are given in the following table. The same axis parameters can be read with the MC\_ReadAxisParameter (Read Axis Parameter) instruction.

Axis parameter type	Axis parameter name	OK: Can be read and written. ---: Cannot be read and written.
Axis Basic Settings	Axis Number	---
	Motion Control <sup>*1</sup>	---
	Axis Use	---
	Axis Type	---
	Control Function <sup>*2</sup>	---
	Input Device/Output Device	---
Unit Conversion Settings	Unit of Display	OK
	Command Pulse Count Per Motor Rotation	OK
	Work Travel Distance Per Motor Rotation	OK
	Reducer Use <sup>*3</sup>	OK
	Work Travel Distance Per Rotation <sup>*3</sup>	OK <sup>*4</sup>
	Work Gear Ratio <sup>*3</sup>	OK
	Motor Gear Ratio <sup>*3</sup>	OK
Operation Settings	Maximum Velocity	OK <sup>*5</sup>
	Start Velocity	OK <sup>*5</sup>
	Maximum Jog Velocity	OK <sup>*5</sup>
	Maximum Acceleration	OK <sup>*5</sup>
	Maximum Deceleration	OK <sup>*5</sup>
	Acceleration/Deceleration Over	OK <sup>*5</sup>
	Operation Selection at Reversing	OK <sup>*5</sup>
	Velocity Warning Value	OK <sup>*5</sup>
	Acceleration Warning Value	OK <sup>*5</sup>
	Deceleration Warning Value	OK <sup>*5</sup>

Axis parameter type	Axis parameter name	OK: Can be read and written. ---: Cannot be read and written.
	Positive Torque Warning Value <sup>*6</sup>	OK <sup>*5</sup>
	Negative Torque Warning Value <sup>*6</sup>	OK <sup>*5</sup>
	In-position Range	OK <sup>*5</sup>
	In-position Check Time	OK <sup>*5</sup>
	Actual Velocity Filter Time Constant	OK
	Zero Position Range	OK <sup>*5</sup>
Other Operation Settings	Immediate Stop Input Stop Method	OK <sup>*5</sup>
	Limit Input Stop Method	OK <sup>*5</sup>
	Drive Error Reset Monitoring Time	OK <sup>*5</sup>
	Maximum Positive Torque Limit	OK <sup>*5</sup>
	Maximum Negative Torque Limit	OK <sup>*5</sup>
	Immediate Stop Input Logic Inversion	OK <sup>*5</sup>
	Positive Limit Input Logic Inversion	OK <sup>*5</sup>
	Negative Limit Input Logic Inversion	OK <sup>*5</sup>
	Home Proximity Input Logic Inversion	OK <sup>*5</sup>
Limit Settings	Software Limits	OK <sup>*5</sup>
	Positive Software Limit	OK <sup>*5</sup>
	Negative Software Limit	OK <sup>*5</sup>
	Following Error Over Value	OK <sup>*5</sup>
	Following Error Warning Value	OK <sup>*5</sup>
Position Count Settings	Count Mode	OK
	Modulo Maximum Position Setting Value	OK
	Modulo Minimum Position Setting Value	OK
	Encoder Type	---
Servo Drive Settings	Modulo Maximum Position Setting Value	---
	Modulo Minimum Position Setting Value	---
	PDS State Control Method <sup>*7</sup>	---
Homing Settings	Homing Method	OK <sup>*5</sup>
	Home Input Signal	OK <sup>*5</sup>
	Homing Start Direction	OK <sup>*5</sup>
	Home Input Detection Direction	OK <sup>*5</sup>
	Operation Selection at Positive Limit Input	OK <sup>*5</sup>
	Operation Selection at Negative Limit Input	OK <sup>*5</sup>
	Homing Velocity	OK <sup>*5</sup>
	Homing Approach Velocity	OK <sup>*5</sup>
	Homing Acceleration	OK <sup>*5</sup>
	Homing Deceleration	OK <sup>*5</sup>
	Homing Jerk	OK <sup>*5</sup>
	Home Input Mask Distance	OK <sup>*5</sup>
	Home Offset	OK <sup>*5</sup>

Axis parameter type	Axis parameter name	OK: Can be read and written. ---: Cannot be read and written.
	Homing Holding Time	OK <sup>*5</sup>
	Homing Compensation Value	OK <sup>*5</sup>
	Homing Compensation Velocity	OK <sup>*5</sup>

- \*1. You can use this parameter only with NX701 CPU Units.
- \*2. You can use this parameter only with NX102 and NX1P2 CPU Units.
- \*3. A CPU Unit with unit version 1.11 or later and Sysmac Studio version 1.15 or higher are required to use this parameter.
- \*4. If **Reducer Use** of an axis for which to write a parameter is set to TRUE and the **Count Mode** of the axis is **Rotary Mode**, the value of **Work Travel Distance Per Rotation** is not written. The value of **Work Travel Distance Per Rotation** is determined by subtracting the modulo minimum position from the modulo maximum position. If **Reducer Use** of an axis for which to read a parameter is set to TRUE and the **Count Mode** of the axis is **Rotary Mode**, the value obtained by subtracting the modulo minimum position from the modulo maximum position is read as **Work Travel Distance Per Rotation**.
- \*5. If **Axis Type** of the axis specified for writing is an **Encoder axis** or a **Virtual encoder axis**, the axis parameters are not written. Also, if **Axis Type** of the axis specified for reading is an **Encoder axis** or a **Virtual encoder axis**, the default values of the axis parameters are read.  
For the default values of the axis parameters, refer to the *NJ/NX-series CPU Unit Motion Control User's Manual (Cat. No. W507)*.
- \*6. This parameter is enabled only for torque control.
- \*7. A CPU Unit with unit version 1.10 or later and Sysmac Studio version 1.12 or higher are required to use this parameter.

## Timing Charts

A timing chart for execution of the MC\_WriteAxisParameter (Write Axis Parameters) instruction is shown below.

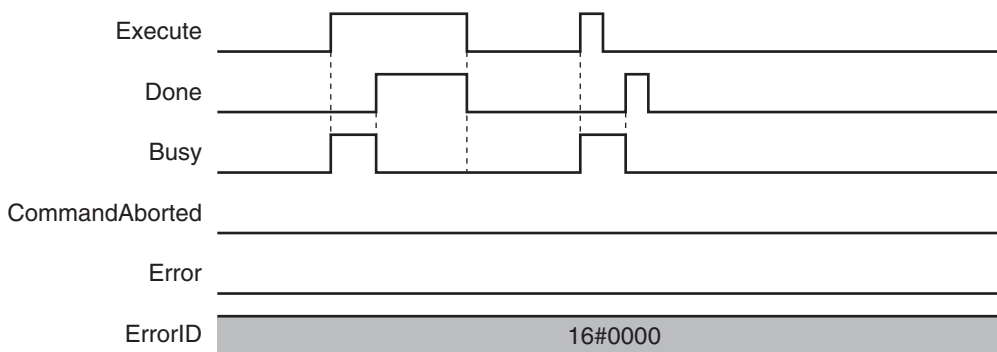

## Re-execution of Motion Control Instructions

For details on re-execution of motion control instructions, refer to the *NJ/NX-series CPU Unit Motion Control User's Manual (Cat. No. W507)*.

## Multi-execution of Motion Control Instructions

For details on multi-execution of motion control instructions, refer to the *NJ/NX-series CPU Unit Motion Control User's Manual (Cat. No. W507)*.

# Errors

If an error occurs during instruction execution, *Error* will change to TRUE and parameters are not written. The values before the instruction was executed will be held.

You can find out the cause of the error by referring to the value output by *ErrorID* (Error Code). Depending on *ErrorID* (Error Code), attached information is output to *ErrorParameterCode* (Parameter Detail Code).

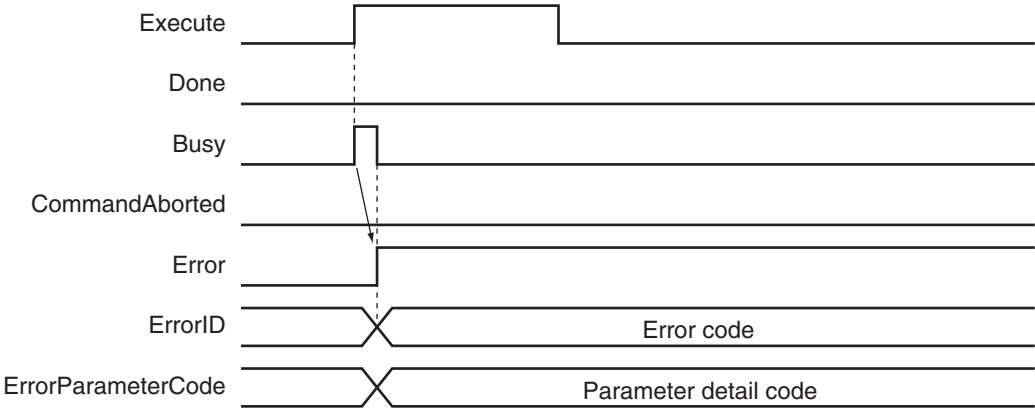

## ● Error Codes

Refer to the *NJ/NX-series Troubleshooting Manual (Cat. No. W503)* for instruction errors.

# MC\_ReadAxisParameter

The MC\_ReadAxisParameter instruction reads axis parameters in the MC Function Module.

Instruction	Name	FB/ FUN	Graphic expression	ST expression
MC_ReadAxis- Parameter	Read Axis Parameters	FB		<pre>MC_ReadAxisParameter (   Axis :=parameter,   AxisParameter :=parameter,   Execute :=parameter,   Done =&gt;parameter,   Busy =&gt;parameter,   CommandAborted =&gt;parameter,   Error =&gt;parameter,   ErrorID =&gt;parameter );</pre>



## Version Information

A CPU Unit with unit version 1.08 or later and Sysmac Studio version 1.09 or higher are required to use this instruction.

## Variables

### Input Variables

Name	Meaning	Data type	Valid range	Default	Description
Execute	Execute	BOOL	TRUE or FALSE	FALSE	The instruction is executed when the value of this variable changes to TRUE.

### Output Variables

Name	Meaning	Data type	Valid range	Description
Done	Done	BOOL	TRUE or FALSE	TRUE when the instruction is completed.
Busy	Executing	BOOL	TRUE or FALSE	TRUE when the instruction is acknowledged.
CommandAborted	Command Aborted	BOOL	TRUE or FALSE	TRUE when the instruction is aborted.
Error	Error	BOOL	TRUE or FALSE	TRUE while there is an error.
ErrorID	Error Code	WORD	*1	Contains the error code when an error occurs. A value of 16#0000 indicates normal execution.

\*1. The upper four digits of the event code give the error code for ErrorID. Refer to the *NJ/NX-series Troubleshooting Manual (Cat. No. W503)* for the event codes.

## ● Output Variable Update Timing

Name	Timing for changing to TRUE	Timing for changing to FALSE
Done	When the instruction is completed.	<ul style="list-style-type: none"> <li>When <i>Execute</i> is TRUE and changes to FALSE.</li> <li>After one period when <i>Execute</i> is FALSE.</li> </ul>
Busy	When <i>Execute</i> changes to TRUE.	<ul style="list-style-type: none"> <li>When <i>Done</i> changes to TRUE.</li> <li>When <i>Error</i> changes to TRUE.</li> <li>When <i>CommandAborted</i> changes to TRUE.</li> </ul>
CommandAborted	When this instruction is canceled due to an error.	<ul style="list-style-type: none"> <li>When <i>Execute</i> is TRUE and changes to FALSE.</li> <li>After one period when <i>Execute</i> is FALSE.</li> </ul>
Error	When there is an error in the execution conditions or input parameters for the instruction.	When the error is cleared.

## In-Out Variables

Name	Meaning	Data type	Valid range	Description
Axis	Axis	_sAXIS_REF	---	Specify the axis for which to read the parameters. *1
AxisParameter	Axis Parameters	_sAXIS_PARAM	---	Stores the read values. *2

\*1. Specify a user-defined Axis Variable that was created in the Axis Basic Settings of the Sysmac Studio (default: MC\_Axis\*) or a system-defined axis variable name (\_MC\_AX[\*], \_MC1\_AX[\*], or \_MC2\_AX[\*]).

If you use Sysmac Studio version 1.29 or higher, you can specify the system-defined axis variable name for AT specification of a user-defined variable. This will allow you to specify the user-defined variable.

If you use Sysmac Studio version 1.28 or lower, do not specify any user-defined variable created in the variable table.

\*2. Define a user-defined variable with a data type of \_sAXIS\_PARAM.

## ● \_sAXIS\_PARAM

Member	Parameter name	Data type *1	Function
UnitConversion	Unit Conversion Settings	_sAXIS_UNIT_CONVERSION_SETTINGS	The values that are read for the unit conversion settings are stored in the member variables.
Operation	Operation Settings	_sAXIS_OPERATION_SETTINGS	The values that are read for the operation settings are stored in the member variables.
OtherOperation	Other Operation Settings	_sAXIS_OTHER_OPERATION_SETTINGS	The values that are read for the other operation settings are stored in the member variables.
Limit	Limit Settings	_sAXIS_LIMIT_SETTINGS	The values that are read for the limit settings are stored in the member variables.
PosCount	Position Count Settings	_sAXIS_POSITION_COUNT_SETTINGS	The values that are read for the position count settings are stored in the member variables.
Homing	Homing Settings	_sAXIS_HOMING_SETTINGS	The values that are read for the homing settings are stored in the member variables.

Member	Parameter name	Data type *1	Function
(Reserved)	(Reserved area)	ARRAY[0..255] OF BYTE	---

\*1. Refer to `_sAXIS_PARAM` on page 5-53 for details on the data types.

## Function

- When *Execute* changes to TRUE, the `MC_ReadAxisParameter` instruction reads the axis parameters of the axis specified with *Axis* and outputs them to *AxisParameter* (Axis Parameters).
- You can use this instruction to read the axis parameters regardless of the status of the *Cfg.AxEnable* (Axis Use) axis variable.



### Precautions for Correct Use

- This instruction reads the values of the axis parameters that are valid when the instruction is executed, and not the values that are saved in the non-volatile memory of the CPU Unit. For example, if you write the axis parameters with the `MC_Write` (Write MC Setting) instruction, the written axis parameters are read.
- If you use this instruction together with the `MC_WriteAxisParameter` (Write Axis Parameters) instruction, check *Done* from the `MC_WriteAxisParameter` (Write Axis Parameters) before you read the axis parameters.
- The values of the axis parameters are output to *AxisParameter* (Axis Parameters) only at the completion of instruction execution. They are not written to *AxisParameter* (Axis Parameters) after that. Therefore, if you write values to *AxisParameter* (Axis Parameters), the previous values are overwritten.

## Axis Parameters That Are Read

Refer to *Axis Parameters That Are Written and Read* on page 5-60 for the parameters that are read by this instruction.

## Timing Charts

A timing chart for execution of the `MC_ReadAxisParameter` (Read Axis Parameters) instruction is shown below.

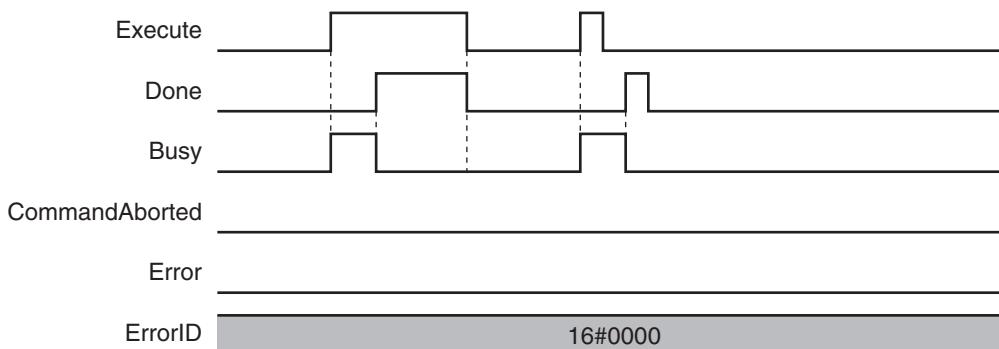



## Re-execution of Motion Control Instructions

For details on re-execution of motion control instructions, refer to the *NJ/NX-series CPU Unit Motion Control User's Manual (Cat. No. W507)*.

## Multi-execution of Motion Control Instructions

For details on multi-execution of motion control instructions, refer to the *NJ/NX-series CPU Unit Motion Control User's Manual (Cat. No. W507)*.

## Errors

If an error occurs during instruction execution, *Error* will change to TRUE. You can find out the cause of the error by referring to the value output by *ErrorID* (Error Code).

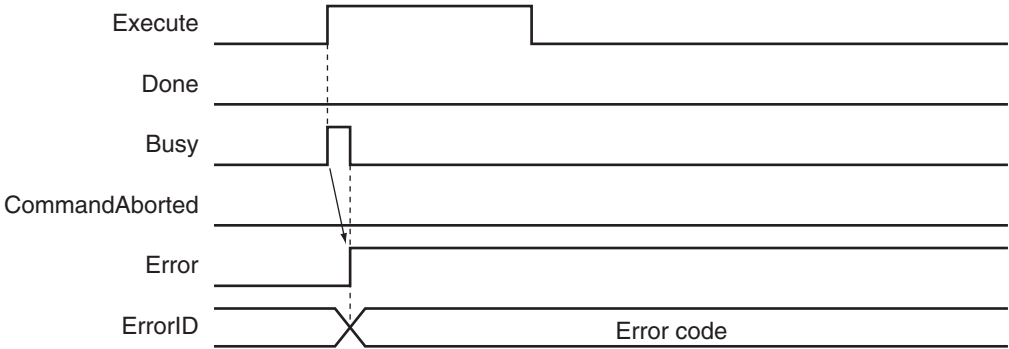

### ● Error Codes

Refer to the *NJ/NX-series Troubleshooting Manual (Cat. No. W503)* for instruction errors.





# Appendices

The appendices describe instructions for which multi-execution is supported and version information.

---

<b>A-1</b>	<b>Instructions for Which Multi-execution Is Supported.....</b>	<b>A-2</b>
A-1-1	Axis and Axes Group Status .....	A-2
A-1-2	State Transitions and Instructions for which Multi-execution Is Supported .....	A-4
<b>A-2</b>	<b>Version Information .....</b>	<b>A-11</b>

A

# A-1 Instructions for Which Multi-execution Is Supported

Whether multi-execution of motion control instructions is supported depends on the current axis status, the current axes group status, and the instruction to execute. This section describes the relationships between these.

For details on multi-execution of instructions, refer to the *NJ/NX-series CPU Unit Motion Control User's Manual (Cat. No. W507)*.



## Precautions for Correct Use

- Only one instruction is buffered for each single axis. If you attempt to perform multi-execution for two or more instructions, an instruction error will occur.
- Up to seven instructions can be buffered at the same time for a single axes group. If you attempt to perform multi-execution for eight or more instructions, an instruction error will occur.
- Multi-execution of instructions cannot be used to execute an axes group command instruction for an axis that is operating for an axis command instruction. Multi-execution of instructions cannot be used to execute an axis command instruction for an axis that is operating for an axes group command instruction. An instruction error will occur if these rules are broken.

## A-1-1 Axis and Axes Group Status

Whether multi-execution of motion control instructions is supported depends on the current axis status and the current axes group status. You can use the Axis variable and the Axes Group variable of the relevant axis to find the axis status and the axes group status.

For details on axis status, axes status, Axis variables, and Axes Group variables, refer to the *NJ/NX-series CPU Unit Motion Control User's Manual (Cat. No. W507)*.

## Variables in an Axis Variable That Give the Axis Status

The following nine variables in an Axis variable give the status of the axis. These variables are mutually exclusive. Only one of them can be TRUE at any one time.

An example is given here for `_MC_AX[0..255]`. The same information applies to `_MC1_AX[0..255]` and `_MC2_AX[0..255]`.

Name	Data type	Meaning	Function
<code>_MC_AX[0-255]</code>	<code>_sAXIS_REF</code>	Axis Variable	
Status	<code>_sAXIS_REF_STA</code>	Axis Status	
Disabled	BOOL	Axis Disabled	TRUE while the Servo is OFF for the axis.
Standstill	BOOL	Standstill	TRUE while the Servo is ON for the axis.
Discrete	BOOL	Discrete Motion	TRUE while position control is executed toward the target position. This includes when the velocity is 0 because the override factor was set to 0 during a discrete motion.

Name	Data type	Meaning	Function
Continuous	BOOL	Continuous Motion	TRUE during continuous motion without a target position. This state exists during velocity control or torque control. This includes when the velocity is 0 because the target velocity is set to 0 and when the velocity is 0 due to an override factor set to 0 during continuous motion.
Synchron-ized	BOOL	Synchron-ized Motion	TRUE during execution of synchronized control. This includes waiting for synchronization after changing to synchronized control instructions.
Homing	BOOL	Homing	TRUE when homing for the MC_Home or MC_HomeWithParameter instruction.
Stopping	BOOL	Deceleration Stopping	TRUE until the axis stops for a MC_Stop or MC_TouchProbe instruction. This includes when <i>Execute</i> is TRUE after the axis stops for an MC_Stop instruction. Axis motion instructions are not executed in this state (CommandAborted = TRUE).
ErrorStop	BOOL	Error Decel-eration Stop-ping	TRUE while the axis is stopping or stopped for the MC_ImmediateStop instruction or for an axis minor fault (when <i>_MC_AX[*].MFAultLvl.Active</i> is TRUE). Axis motion instructions are not executed in this state (CommandAborted = TRUE).
Coordinated	BOOL	Coordinated Motion	TRUE when an axes group is enabled by a multi-axes coordinated control instruction.



## Variables in an Axes Group Variable That Give the Axes Group Status

The following five variables in an Axes Group variable give the status of the axes group. These variables are mutually exclusive. Only one of them can be TRUE at any one time.

An example is given here for *\_MC\_GRP[0..63]*.

The same information applies to *\_MC1\_GRP[0..63]* and *\_MC2\_GRP[0..63]*.

Name	Data type	Meaning	Function
<i>_MC_GRP[0-63]</i>	<i>_sGROUP_REF</i>	Axes Group Variable	
Status	<i>_sGROUP_REF_ST A</i>	Axes Group Status	
Disabled	BOOL	Axes Group Disabled	TRUE when the axes group is disabled and stopped.
Standby	BOOL	Standby	TRUE when the axes group motion instruction is stopped. This is independent of the Servo ON/OFF status of the composition axes in the axes group.
Moving	BOOL	Moving	TRUE while an axes group motion instruction is executed toward the target position. This includes in-position waiting status and when the velocity is 0 for an override.

Name	Data type	Meaning	Function
Stopping	BOOL	Deceleration Stopping	TRUE until the axes group stops for an MC_GroupStop instruction. This includes when <i>Execute</i> is TRUE after the axes group stops for an MC_GroupStop instruction. Axis motion instructions are not executed in this state ( <i>CommandAborted</i> = TRUE).
ErrorStop	BOOL	Error Deceleration Stopping	TRUE while the axes group is stopping or stopped for the MC_GroupImmediateStop instruction or for an axes group minor fault (when <i>_MC_GRP[*].MFaultLvl.Active</i> is TRUE). Axes group motion instructions are not executed in this state ( <i>CommandAborted</i> = TRUE).

## A-1-2 State Transitions and Instructions for which Multi-execution Is Supported

This section tells whether multi-execution of motion control instructions is supported based on the axis status and the axes group status. It also gives how the axis status and axes group status change. For details on the state transitions for the MC Function Module and details on motion control instructions in relation to state transitions, refer to the *NJ/NX-series CPU Unit Motion Control User's Manual (Cat. No. W507)*.

### Multi-execution of Instructions for a Servo Axis and Virtual Servo Axis

The following table shows whether multi-execution of the instruction is supported for a servo axis and servo axes group, as well as how the status of the servo axis or servo axes group changes after multi-execution.

The color of the cell in the table tells you if multi-execution of the instruction is supported.

White : Multi-execution of the instruction is supported.

Gray : Multi-execution of the instruction is not supported. An error will occur.

Yellow : Multi-execution of the instruction is not supported. *CommandAborted* changes to TRUE and execution of the instruction is disabled.

Each letter code in the table shows the status to which the axis or axes group changes.

#### Axis Status

- A : Disabled
- B : Standstill
- C : Discrete
- D : Continuous
- E : Synchronized
- F : Homing
- G : Stopping
- H : ErrorStop
- I : Coordinated

#### Axes Group Status

- a : Disabled
- b : Standby
- c : Moving
- d : Stopping
- e : ErrorStop

● Axis Command Instructions

Instruction	Axis status before instruction execution									Axes group status before instruction execution				
	A	B	C	D	E	F	G	H	I	a	b	c	d	e
	Axis Disabled	Standstill	Discrete Motion	Continuous Motion	Synchronized Motion	Homing	Deceleration Stopping	Error Deceleration Stopping	Coordinated Motion	Axes Group Disabled	Standstill	Moving	Deceleration Stopping	Error Deceleration Stopping
MC_Power with Enable = TRUE	*1	B	C	D	E	F	G	H	I	a	b	c	d	e
MC_Power with Enable = FALSE	A	A	A	A	A	A	A	H	I	a	b	*2	d	e
MC_MoveJog	H	D	H	H	H	H	G	H	I	a	e	e	e	e
MC_Home	H	F	H	H	H	H	G	H	I	a	e	e	e	e
MC_HomeWithParameter	H	F	H	H	H	H	G	H	I	a	e	e	e	e
MC_Move	H	C	C	C	C	H	G	H	I	a	e	e	e	e
MC_MoveAbsolute	H	C	C	C	C	H	G	H	I	a	e	e	e	e
MC_MoveRelative	H	C	C	C	C	H	G	H	I	a	e	e	e	e
MC_MoveVelocity	H	D	D	D	D	H	G	H	I	a	e	e	e	e
MC_MoveZeroPosition	H	C	C	C	C	H	G	H	I	a	e	e	e	e
MC_MoveFeed	H	*3	*3	*3	*3	H	G	H	I	a	e	e	e	e
MC_Stop	A	G	G	G	G	G	G	H	I	a	e	e	e	e
MC_ImmediateStop	H	H	H	H	H	H	H	H	I	a	e	e	e	e
MC_SetPosition	A	B	F*4	D*5	H	H	G	H	I	a	e	e	e	e
MC_SetOverride	A	B	C	D	E	F	G	H	I	a	b	c	d	e
MC_ResetFollowingError	H	B	G	G	G	H	G	H	I	a	e	e	e	e
MC_CamIn	H	E	E	E	E	H	G	H	I	a	e	e	e	e
MC_CamIn*6	H	H	H	H	---	H	G	H	---	---	---	---	---	---
MC_CamOut	H	H	H	H	C*7	H	G	H	I	a	e	e	e	e
MC_CamMonitor	A	B	C	D	E	F	G	H	I	a	b	c	d	e
MC_GearIn	H	E	E	E	E	H	G	H	I	a	e	e	e	e
MC_GearIn*6	H	H	H	H	---	H	G	H	---	---	---	---	---	---
MC_GearInPos	H	E	H	H	H	H	G	H	I	a	e	e	e	e
MC_GearInPos*6	H	H	H	H	---	H	G	H	---	---	---	---	---	---
MC_GearOut	H	H	H	H	C*8	H	G	H	I	a	e	e	e	e
MC_MoveLink	H	E	E	E	E	H	G	H	I	a	e	e	e	e

A-1 Instructions for Which Multi-execution is Supported

A

A-1-2 State Transitions and Instructions for which Multi-execution is Supported

Instruction	Axis status before instruction execution									Axes group status before instruction execution				
	A	B	C	D	E	F	G	H	I	a	b	c	d	e
	Axis Disabled	Standstill	Discrete Motion	Continuous Motion	Synchronized Motion	Homing	Deceleration Stopping	Error Deceleration Stopping	Coordinated Motion	Axes Group Disabled	Standstill	Moving	Deceleration Stopping	Error Deceleration Stopping
MC_MoveLink*6	H	H	H	H	---	H	G	H	---	---	---	---	---	---
MC_CombineAxes	H	E	E	E	E	H	G	H	I	a	e	e	e	e
MC_CombineAxes*6	H	H	H	H	---	H	G	H	---	---	---	---	---	---
MC_Phasing	H	H	H	H	E*9	H	G	H	I	a	e	e	e	e
MC_TorqueControl	H	D	D	D	D	H	G	H	I	a	e	e	e	e
MC_TorqueControl*6	H	H	H	H	---	H	G	H	---	---	---	---	---	---
MC_SetTorqueLimit	A	B	C	D	E	F	G	H	I	a	b	c	d	e
MC_ZoneSwitch	A	B	C	D	E	F	G	H	I	a	b	c	d	e
MC_TouchProbe	A	B	C	D	E	H	G	H	I	a	e	e	e	e
MC_AbortTrigger	A	B	C	D*5	E	H	G	H	I	a	e	e	e	e
			*10											
MC_AxesObserve	A	B	C	D	E	F	G	H	I	a	b	c	d	e
MC_SyncMoveVelocity	H	D	D	D	D	H	G	H	I	a	e	e	e	e
MC_SyncMoveVelocity*6	H	H	H	H	---	H	G	H	---	---	---	---	---	---
MC_SyncMoveAbsolute	H	C	C	C	C	H	G	H	I	a	e	e	e	e
MC_Reset	A	B	C	D	E	F	G	*11	I	a	b	c	d	e
MC_ChangeAxisUse (Change unused axis to used axis)	A	---	---	---	---	---	---	---	---	---	---	---	---	---
MC_ChangeAxisUse (Change used axis to unused axis)	---	*12	H	H	H	H	H	H	H	a	b	c	d	e
MC_DigitalCamSwitch	A	B	C	D	E	F	G	H	I	a	b	c	d	e
MC_TimeStampToPos	A	B	C	D	E	F	G	H	I	a	b	c	d	e
MC_PeriodicSyncVariables	A	B	C	D	E	F	G	H	I	a	b	c	d	e
MC_SyncOffsetPosition	H	H	H	H	E	H	G	H	I	a	e	e	e	e
MC_OffsetPosition	H	H	H	H	E	H	G	H	I	a	e	e	e	e

- \*1. If *Execute* for the MC\_Stop instruction is FALSE, the status will change to Standstill (B). If the value of this variable is TRUE, the status will change to Deceleration Stopping (G).
- \*2. The status will change to Standstill (b) or Deceleration Stopping (d) depending on the maximum deceleration rate.
- \*3. If a target position is set, the status will change to Discrete Motion (C). Otherwise, the status will change to Continuous Motion (D).
- \*4. If the MC\_MoveZeroPosition instruction is being executed, an error will occur and the status will change to Error Deceleration Stopping (H).
- \*5. If the MC\_TorqueControl instruction or the MC\_SyncMoveVelocity instruction is being executed, an error will occur and the status will change to Error Deceleration Stopping (H).



- \*6. The axis function control is set to **1: single-axis control/motion profile command control (command position output only) enabled**.
- \*7. If the MC\_CamIn instruction is not being executed, an error will occur and the status will change to Error Deceleration Stopping (H).
- \*8. If the MC\_GearIn instruction or the MC\_GearInPos instruction is not being executed, an error will occur and the status will change to Error Deceleration Stopping (H).
- \*9. If the MC\_CombineAxes instruction is being executed, an error will occur and the status will change to Error Deceleration Stopping (H).
- \*10. If *LatchID* for the MC\_AbortTrigger instruction is the same as the *LatchID* for the MC\_MoveFeed instruction, an error will occur and the status will change to Error Deceleration Stopping (H).
- \*11. The status changes as follows for the given conditions:
  - If the error is reset successfully when the servo is OFF or if *Execute* of the MC\_Stop instruction is TRUE, the status will change to Axis Disabled (A).
  - If the error is reset successfully when the servo is ON, the status will change to Standstill (B).
  - If *Execute* for the MC\_Stop instruction is TRUE, the status will change to Deceleration Stopping (G).
  - If resetting the error fails, the status will change to Error Deceleration Stopping (H) regardless of whether the servo is ON or OFF.
- \*12. If `_MC_AX[*].Details.VelLimit` (Command Velocity Saturation) in the Axis Variable is TRUE, the status will change to Error Deceleration Stopping (H). If it is FALSE, the axis will change to an unused axis, so the axis status will be ---.



**Precautions for Correct Use**

For an NX-series CPU Unit, a variable name that starts with `_MC_AX[*]` may start with `_MC1_AX[*]` or `_MC2_AX[*]` instead.

**● Axes Group Instructions**

Instruction	Axis status before instruction execution									Axes group status before instruction execution				
	A	B	C	D	E	F	G	H	I	a	b	c	d	e
	Axis Disabled	Standstill	Discrete Motion	Continuous Motion	Synchronized Motion	Homing	Deceleration Stopping	Error Deceleration Stopping	Coordinated Motion	Axes Group Disabled	Standstill	Moving	Deceleration Stopping	Error Deceleration Stopping
MC_GroupEnable	I	I	C	D	E	F	G	H	I	b	b	c	d	e*1
MC_GroupDisable	A	B	C	D	E	F	G	H	*2	a	a	a	a	e
MC_MoveLinear	A	B	C	D	E	F	G	H	I	e	c	c	d	e
MC_MoveLinearAbsolute	A	B	C	D	E	F	G	H	I	e	c	c	d	e
MC_MoveLinearRelative	A	B	C	D	E	F	G	H	I	e	c	c	d	e
MC_MoveCircular2D	A	B	C	D	E	F	G	H	I	e	c	c	d	e
MC_GroupStop	A	B	C	D	E	F	G	H	I	e	d	d	d	e
MC_GroupImmediateStop	A	B	C	D	E	F	G	H	I	e	e	e	e	e
MC_GroupSetOverride	A	B	C	D	E	F	G	H	I	a	b	c	d	e
MC_GroupReadPosition	A	B	C	D	E	F	G	H	I	a	b	c	d	e
MC_ChangeAxesInGroup	A	B	C	D	E	F	G	H	I	a*3	e	e	e	e*4

Instruction	Axis status before instruction execution									Axes group status before instruction execution				
	A	B	C	D	E	F	G	H	I	a	b	c	d	e
	Axis Disabled	Standstill	Discrete Motion	Continuous Motion	Synchronized Motion	Homing	Deceleration Stopping	Error Deceleration Stopping	Coordinated Motion	Axes Group Disabled	Standstill	Moving	Deceleration Stopping	Error Deceleration Stopping
<b>MC_GroupSyncMoveAbsolute</b>	A	B	C	D	E	F	G	H	I	e	c	c	d	e
<b>MC_GroupReset</b>	A	B	C	D	E	F	G	H	I	a	b	c	d	*5

- \*1. If the servo is OFF, *CommandAborted* changes to TRUE.
- \*2. The status changes as follows for the given conditions:
  - If there is no error and the servo is OFF, the status will change to Axis Disabled (A).
  - If *Execute* for the MC\_GroupStop instruction is FALSE and the servo is OFF, the status will change to Standstill (B).
  - If *Execute* for the MC\_GroupStop instruction is TRUE and the servo is ON, the status will change to Deceleration Stopping (G).
  - If an error occurs, the status will change to Error Deceleration Stopping (H) regardless of whether the servo is ON or OFF.
- \*3. If the MC\_GroupEnable instruction is being executed, an error will occur and the status will change to Error Deceleration Stopping (e).  
An error will occur if the axis is in single-axis position control, as it cannot be set as the axes group composition axis.
- \*4. An error will occur if the servo is ON.
- \*5. The status changes as follows for the given conditions:
  - If the error is reset successfully when the servo is OFF, the status will change to Axes Group Disabled (a).
  - If the error is reset successfully when the servo is ON, the status will change to Standstill (b).
  - If *Execute* for the MC\_GroupStop instruction is TRUE and the servo is ON, the status will change to Deceleration Stopping (d).

### ● Common Command Instructions

You can perform multi-execution of common command instructions regardless of the status of the axis or axes group.

Also, the axis status and axes group status will not change when you execute a common command instruction. The current status is maintained.

## Multi-execution of Instructions for an Encoder Axis and Virtual Encoder Axis

The following table shows whether multi-execution of the instruction is supported for an encoder axis, as well as how the status of the encoder axis changes after multi-execution.

The color of the cell in the table tells you if multi-execution of the instruction is supported.

White : Multi-execution of the instruction is supported.

Gray : Multi-execution of the instruction is not supported. An error will occur.  
 Yellow : Multi-execution of the instruction is not supported. *CommandAborted* changes to TRUE and execution of the instruction is disabled.

Each letter code in the table shows the status to which the axis changes.

**Axis Status**

A : Disabled  
 H : ErrorStop

● **Axis Command Instructions**

Instruction	Axis status before instruction execution	
	A	H
	Axis Disabled	Error Deceleration Stopping
MC_Power	H	H
MC_MoveJog	H	H
MC_Home	H	H
MC_HomeWithParameter	H	H
MC_Move	H	H
MC_MoveAbsolute	H	H
MC_MoveRelative	H	H
MC_MoveVelocity	H	H
MC_MoveZeroPosition	H	H
MC_MoveFeed	H	H
MC_Stop	H	H
MC_ImmediateStop	H	H
MC_SetPosition	A	H
MC_SetOverride	H	H
MC_ResetFollowingError	H	H
MC_CamIn	H	H
MC_CamOut	H	H
MC_CamMonitor	H	H
MC_GearIn	H	H
MC_GearInPos	H	H
MC_GearOut	H	H
MC_MoveLink	H	H
MC_CombineAxes	H	H
MC_Phasing	H	H
MC_TorqueControl	H	H
MC_SetTorqueLimit	H	H
MC_ZoneSwitch	A	H
MC_TouchProbe	A	H
MC_AbortTrigger	A	H
MC_AxesObserve	A	H
MC_SyncMoveVelocity	H	H
MC_SyncMoveAbsolute	H	H
MC_Reset	A	A
MC_ChangeAxisUse (Change unused axis to used axis)	A	H

A-1 Instructions for Which Multi-execution Is Supported

A

A-1-2 State Transitions and Instructions for which Multi-execution Is Supported

Instruction	Axis status before instruction execution	
	A	H
	Axis Disabled	Error Deceleration Stopping
MC_ChangeAxisUse (Change used axis to unused axis)	---	H
MC_DigitalCamSwitch	A	H
MC_TimeStampToPos	A	H
MC_PeriodicSyncVariables	A	H
MC_SyncOffsetPosition	H	H
MC_OffsetPosition	H	H

● **Axes Group Instructions**

You cannot set encoder and virtual encoder axes as axes group composition axes. Therefore, an error will occur if you perform multi-execution of axes group command instructions for an encoder axis or virtual encoder axis.

● **Common Command Instructions**

You can perform multi-execution of common command instructions regardless of the status of the axis.

Also, the axis status will not change when you execute a common command instruction. The current status is maintained.

## A-2 Version Information

This appendix provides information related to the different unit versions of the NJ/NX-series CPU Units and for different versions of the Sysmac Studio.

### Instructions with Specifications Changes and New Instructions for Version Upgrades

The instructions that are supported and their specifications depend on the unit version of the CPU Unit and the version of the Sysmac Studio. These are given in the following table.

Type	Instruction	Name	New/ Changed	Version		Page
				CPU Unit	Sysmac Studio	
Instructions for common commands	MC_Write	Write MC Setting	Changed	Ver.1.01	Ver.1.02	page 5-13
			Changed	Ver.1.10	Ver.1.12	
	MC_GenerateCamTable	Generate Cam Table	New	Ver.1.08	Ver.1.09	page 5-19
	MC_WriteAxisParameter	Write Axis Parameters	New	Ver.1.08	Ver.1.09	page 5-49
Changed			Ver.1.10	Ver.1.12		
MC_ReadAxisParameter	Read Axis Parameters	New	Ver.1.08	Ver.1.09	page 5-64	
		Changed	Ver.1.10	Ver.1.12		
Instructions for axes group commands	MC_GroupReadPosition	Read Axes Group Position	New	Ver.1.01	Ver.1.02	page 4-91
	MC_ChangeAxesInGroup	Change Axes in Group	New	Ver.1.01	Ver.1.02	page 4-95
	MC_GroupSyncMoveAbsolute	Axes Group Cyclic Synchronous Absolute Positioning	New	Ver.1.01	Ver.1.02	page 4-99
Instructions for axis commands	MC_Power	Power Servo	Changed	Ver.1.10	Ver.1.12	page 3-3
	MC_SetPosition	Set Position	Changed	Ver.1.10	Ver.1.12	page 3-153
	MC_ResetFollowingError	Reset Following Error Counter	Changed	Ver.1.10	Ver.1.12	page 3-166
	MC_CamIn	Start Cam Operation	Changed	Ver.1.10	Ver.1.12	page 3-173
	MC_CamMonitor	Cam Monitor	New	Ver.1.21/ Ver.1.32	Ver.1.28	page 3-237
	MC_CombineAxes	Combine Axes	Changed	Ver.1.10	Ver.1.12	page 3-319
	MC_GearIn	Start Gear Operation	Changed	Ver.1.02	Ver.1.03	page 3-246
			Changed	Ver.1.10	Ver.1.12	
	MC_GearInPos	Positioning Gear Operation	Changed	Ver.1.02	Ver.1.03	page 3-267
			Changed	Ver.1.10	Ver.1.12	
MC_MoveLink	Synchronous Positioning	Changed	Ver.1.10	Ver.1.12	page 3-295	
MC_TouchProbe	Enable External Latch	Changed	Ver.1.10	Ver.1.12	page 3-364	

Type	Instruction	Name	New/ Changed	Version		Page
				CPU Unit	Sysmac Studio	
	MC_HomeWithParameter	Home with Parameters	New	Ver.1.03	Ver.1.04	page 3-41
	MC_SyncMoveAbsolute	Cyclic Synchronous Absolute Positioning	New	Ver.1.03	Ver.1.04	page 3-407
	MC_ChangeAxisUse	Change Axis Use	New	Ver.1.04	Ver.1.05	page 3-418
	MC_DigitalCamSwitch	Enable Digital Cam Switch	New	Ver.1.06	Ver.1.07	page 3-424
			Changed	Ver.1.09	Ver.1.10	
	MC_TimeStampToPos	Time Stamp to Axis Position Calculation	New	Ver.1.06	Ver.1.07	page 3-444
	MC_PeriodicSyncVariables	Periodic Axis Variable Synchronization between Tasks	New	Ver.1.10	Ver.1.13	page 3-456
	MC_SyncOffsetPosition	Cyclic Synchronous Position Offset Compensation	New	Ver.1.10	Ver.1.12	page 3-464
	MC_OffsetPosition	Position Offset Compensation	New	Ver.1.21/ Ver.1.32	Ver.1.28	page 3-474

## NX-series Position Interface Units

A CPU Unit with unit version 1.05 or later and Sysmac Studio version 1.06 or higher are required to use the NX-series Position Interface Units.

With the NX-series Position Interface Units, some motion control instructions are subject to functional restrictions and others cannot be used. Refer to the *NX-series Position Interface Units User's Manual* (Cat. No. W524) for details.



# Index



# Index

- A**
- Absolute Linear Interpolation..... 4-40
  - Absolute Positioning..... 3-52
  - Axes Group Cyclic Synchronous Absolute Positioning... 4-99
  - Axes Group Immediate Stop..... 4-82
- C**
- Cam Monitor..... 3-237
  - Change Axes in Group..... 4-95
  - Change Axis Use..... 3-418
  - Circular 2D Interpolation..... 4-46
  - circular interpolation..... 4-46
  - Combine Axes..... 3-319
  - Cyclic Synchronous Absolute Positioning..... 3-407
  - Cyclic Synchronous Position Offset Compensation..... 3-464
  - Cyclic Synchronous Velocity Control..... 3-397
- D**
- Disable Axes Group..... 4-6
  - Disable External Latch..... 3-386
- E**
- electronic gear..... 3-267
  - Enable Axes Group..... 4-2
  - Enable Digital Cam Switch..... 3-424
  - Enable External Latch..... 3-364
  - End Cam Operation..... 3-232
  - End Gear Operation..... 3-290
  - Error Reset..... 3-414, 4-106
  - Execution ID..... 2-12
- G**
- gear operation..... 3-267
  - Generate Cam Table..... 5-19
  - Group Reset..... 4-106
  - Group Stop..... 4-74
- H**
- High-speed Home..... 3-103
  - Home..... 3-18
  - Home with Parameters..... 3-41
- I**
- Immediate Stop..... 3-148
  - Interrupt Feeding..... 3-110
- J**
- Jog..... 3-8
- L**
- Linear Interpolation..... 4-11, 4-40, 4-43
- M**
- MC\_AbortTrigger (Disable External Latch)..... 3-386
  - MC\_AxesObserve (Monitor Axis Following Error)..... 3-390
  - MC\_CamIn (Start Cam Operation)..... 3-173
  - MC\_CamMonitor (Cam Monitor)..... 3-237
  - MC\_CamOut (End Cam Operation)..... 3-232
  - MC\_ChangeAxesInGroup (Change Axes in Group)..... 4-95
  - MC\_ChangeAxisUse (Change Axis Use)..... 3-418
  - MC\_CombineAxes (Combine Axes)..... 3-319
  - MC\_DigitalCamSwitch (Enable Digital Cam Switch)..... 3-424
  - MC\_GearIn (Start Gear Operation)..... 3-246
  - MC\_GearInPos (Positioning Gear Operation)..... 3-267
  - MC\_GearOut (End Gear Operation)..... 3-290
  - MC\_GenerateCamTable (Generate Cam Table)..... 5-19
  - MC\_GroupDisable (Disable Axes Group)..... 4-6
  - MC\_GroupEnable (Enable Axes Group)..... 4-2
  - MC\_GroupImmediateStop (Axes Group Immediate Stop)..... 4-82
  - MC\_GroupReadPosition (Read Axes Group Position)..... 4-91
  - MC\_GroupReset (Group Reset)..... 4-106
  - MC\_GroupSetOverride (Set Group Overrides)..... 4-86
  - MC\_GroupStop (Group Stop)..... 4-74
  - MC\_GroupSyncMoveAbsolute (Axes Group Cyclic Synchronous Absolute Positioning)..... 4-99
  - MC\_Home (Home)..... 3-18
  - MC\_HomeWithParameter (Home with Parameters)..... 3-41
  - MC\_ImmediateStop (Immediate Stop)..... 3-148
  - MC\_Move (Positioning)..... 3-47
  - MC\_MoveAbsolute (Absolute Positioning)..... 3-52
  - MC\_MoveCircular2D (Circular 2D Interpolation)..... 4-46
  - MC\_MoveFeed (Interrupt Feeding)..... 3-110
  - MC\_MoveJog (Jog)..... 3-8
  - MC\_MoveLinear (Linear Interpolation)..... 4-11
  - MC\_MoveLinearAbsolute (Absolute Linear Interpolation)..... 4-40
  - MC\_MoveLinearRelative (Relative Linear Interpolation)..... 4-43
  - MC\_MoveLink (Synchronous Positioning)..... 3-295
  - MC\_MoveRelative (Relative Positioning)..... 3-79
  - MC\_MoveVelocity (Velocity Control)..... 3-87
  - MC\_MoveZeroPosition (High-speed Home)..... 3-103
  - MC\_OffsetPosition (Position Offset Compensation)..... 3-474
  - MC\_PeriodicSyncVariables (Periodic Axis Variable Synchronization between Tasks)..... 3-456
  - MC\_Phasing (Shift Master Axis Phase)..... 3-331
  - MC\_Power (Power Servo)..... 3-3
  - MC\_ReadAxisParameter (Read Axis Parameters)..... 5-64
  - MC\_Reset (Reset Axis Error)..... 3-414
  - MC\_ResetFollowingError (Reset Following Error Counter)..... 3-166
  - MC\_SaveCamTable (Save Cam Table)..... 5-8



- MC\_SetCamTableProperty (Set Cam Table Properties)... 5-2  
 MC\_SetOverride (Set Override Factors)..... 3-160  
 MC\_SetPosition (Set Position)..... 3-153  
 MC\_SetTorqueLimit (Set Torque Limit)..... 3-351  
 MC\_Stop (Stop)..... 3-139  
 MC\_SyncMoveAbsolute (Cyclic Synchronous Absolute Positioning)..... 3-407  
 MC\_SyncMoveVelocity (Cyclic Synchronous Velocity Control)..... 3-397  
 MC\_SyncOffsetPosition (Cyclic Synchronous Position Offset Compensation)..... 3-464  
 MC\_TimeStampToPos (Time Stamp to Axis Position Calculation)..... 3-444  
 MC\_TorqueControl (Torque Control)..... 3-338  
 MC\_TouchProbe (Enable External Latch)..... 3-364  
 MC\_Write (Write MC Setting)..... 5-13  
 MC\_WriteAxisParameter (Write Axis Parameters)..... 5-49  
 MC\_ZoneSwitch (Zone Monitor)..... 3-358  
 Monitor Axis Following Error..... 3-390
- P**
- 
- Periodic Axis Variable Synchronization between Tasks 3-456  
 phase shift..... 3-331  
 Position Offset Compensation..... 3-474  
 Positioning ..... 3-47, 3-52, 3-79, 3-110  
 Positioning Gear Operation..... 3-267  
 Power Servo..... 3-3
- R**
- 
- Read Axes Group Position..... 4-91  
 Read Axis Parameters..... 5-64  
 Relative Linear Interpolation..... 4-43  
 Relative Positioning..... 3-79  
 Reset Axis Error..... 3-414  
 Reset Following Error Counter..... 3-166
- S**
- 
- Save Cam Table..... 5-8  
 Set Cam Table Properties..... 5-2  
 Set Group Overrides..... 4-86  
 Set Override Factors..... 3-160, 4-86  
 Set Position..... 3-153  
 Set Torque Limit..... 3-351  
 Shift Master Axis Phase..... 3-331  
 Start Cam Operation..... 3-173  
 Start Gear Operation..... 3-246  
 Stop..... 3-139, 4-74  
 Synchronous Positioning..... 3-295
- T**
- 
- Time Stamp to Axis Position Calculation..... 3-444  
 Torque Control..... 3-338
- V**
- 
- Velocity Control..... 3-87
- version..... 23
- W**
- 
- Write Axis Parameters..... 5-49  
 Write MC Setting..... 5-13
- Z**
- 
- Zone Monitor..... 3-358





**OMRON Corporation Industrial Automation Company**

**Kyoto, JAPAN**

**Contact : [www.ia.omron.com](http://www.ia.omron.com)**

**Regional Headquarters**

**OMRON EUROPE B.V.**

Wegalaan 67-69, 2132 JD Hoofddorp  
The Netherlands  
Tel: (31) 2356-81-300 Fax: (31) 2356-81-388

**OMRON ELECTRONICS LLC**

2895 Greenspoint Parkway, Suite 200  
Hoffman Estates, IL 60169 U.S.A.  
Tel: (1) 847-843-7900 Fax: (1) 847-843-7787

**OMRON ASIA PACIFIC PTE. LTD.**

438B Alexandra Road, #08-01/02 Alexandra  
Technopark, Singapore 119968  
Tel: (65) 6835-3011 Fax: (65) 6835-3011

**OMRON (CHINA) CO., LTD.**

Room 2211, Bank of China Tower,  
200 Yin Cheng Zhong Road,  
PuDong New Area, Shanghai, 200120, China  
Tel: (86) 21-6023-0333 Fax: (86) 21-5037-2388

**Authorized Distributor:**

©OMRON Corporation 2011-2024 All Rights Reserved.  
In the interest of product improvement,  
specifications are subject to change without notice.

**Cat. No. W508-E1-28 1024**