



Machine Automation Controller NJ-series

# DeviceNet™ Connection Guide

## OMRON Corporation

NE1A-series Safety Network Controller

Network  
Connection  
Guide

## **About Intellectual Property Right and Trademarks**

---

Microsoft product screen shots reprinted with permission from Microsoft Corporation.

Windows is a registered trademark of Microsoft Corporation in the USA and other countries.

ODVA and EtherNet/IP™, DeviceNet™, CIP Safety™ are trademarks of ODVA.

EtherCAT® is registered trademark and patented technology, licensed by Beckhoff Automation GmbH, Germany.

Sysmac is a trademark or registered trademark of OMRON Corporation in Japan and other countries for OMRON factory automation products.

Company names and product names in this document are the trademarks or registered trademarks of their respective companies.

---

## Table of Contents

<b>1. Related Manuals</b> .....	<b>1</b>
<b>2. Terms and Definitions</b> .....	<b>1</b>
<b>3. Remarks</b> .....	<b>2</b>
<b>4. Overview</b> .....	<b>3</b>
<b>5. Applicable Devices and Support Software</b> .....	<b>3</b>
5.1. Applicable Devices .....	3
5.2. Device Configuration .....	4
<b>6. DeviceNet Settings</b> .....	<b>6</b>
6.1. DeviceNet Communications Settings .....	6
6.2. Global Variable Table.....	7
<b>7. Connection Procedure</b> .....	<b>9</b>
7.1. Overview of Setting Up Remote I/O Communications .....	9
7.2. Work Flow.....	10
7.3. Setting Up the Controller .....	11
7.4. Setting Up the Safety Network Controller .....	21
7.5. Connection Status Check .....	39
<b>8. Initialization Method</b> .....	<b>43</b>
8.1. Initializing the Controller .....	43
8.2. Initializing the Safety Network Controller .....	45
<b>9. Appendix Connection Using the “Project File”</b> .....	<b>47</b>
9.1. Project File .....	47
9.2. Overview of Setting Up Remote I/O Communications Using “Project File” ..	47
9.3. Work Flow.....	48
<b>10. Revision History</b> .....	<b>50</b>

## 1. Related Manuals

The table below lists the manuals related to this document.

To ensure system safety, make sure to always read and heed the information provided in all Safety Precautions, Precautions for Safe Use, and Precaution for Correct Use of manuals for each device which is used in the system.

Cat.No.	Model	Manual name
W500	NJ501-□□□□	NJ-series CPU Unit Hardware User's Manual
W501	NJ501-□□□□	NJ-series CPU Unit Software User's Manual
W497	CJ1W-DRM21	CJ-series DeviceNet™ Units Operation Manual for NJ-series CPU Unit
W267	-	DeviceNet™ Operation Manual
W504	SYSMAC-SE2□□□□	Sysmac Studio Version 1 Operation Manual
Z906	NE1A-SCPU01-V1	CIP Safety™ on DeviceNet Safety Network Controller Operation Manual
Z905	-	CIP Safety™ on DeviceNet System Configuration Manual



## 2. Terms and Definitions

Terms	Explanation and Definition
Master/slave	<p>A master is a unit that controls the DeviceNet communications.</p> <p>A master sends output data to multiple slaves and receives input data from the slaves.</p> <p>Slaves receive output data that are sent from the master, and send input data to the master.</p> <p>At least one master is required for DeviceNet communications.</p>
EDS file	A file that contains the I/O points of DeviceNet slaves and the parameters that can be set via DeviceNet.
Node address (MAC ID)	<p>A node address is an address to identify a unit connected to DeviceNet.</p> <p>With DeviceNet, a MAC (Media Access Control) ID is used as a node address. Thus, a node address is a MAC ID.</p>
Scan list	A scan list is used to register slaves with which a master communicates in DeviceNet remote I/O communications. A master communicates with the slaves based on the scan list settings.

### 3. Remarks

- (1) Understand the specifications of devices which are used in the system. Allow some margin for ratings and performance. Provide safety measures, such as installing safety circuit in order to ensure safety and minimize risks of abnormal occurrence.
- (2) To ensure system safety, always read and heed the information provided in all Safety Precautions, Precautions for Safe Use, and Precaution for Correct Use of manuals for each device used in the system.
- (3) The user is encouraged to confirm the standards and regulations that the system must conform to.
- (4) It is prohibited to copy, to reproduce, and to distribute a part of or whole part of this document without the permission of OMRON Corporation.
- (5) The information contained in this document is current as of August 2013. It is subject to change without notice for improvement.

The following notation is used in this document.

 <b>WARNING</b>	Indicates a potentially hazardous situation which, if not avoided, will result in minor or moderate injury, or may result in serious injury or death. Additionally there may be significant property damage.
 <b>Caution</b>	Indicates a potentially hazardous situation which, if not avoided, may result in minor or moderate injury or in property damage.



#### Precautions for Safe Use

Precautions on what to do and what not to do to ensure safe usage of the product.



#### Precautions for Correct Use

Precautions on what to do and what not to do to ensure proper operation and performance.



#### Additional Information

Additional information to read as required.

This information is provided to increase understanding or make operation easier.

### Symbols



The filled circle symbol indicates operations that you must do.  
The specific operation is shown in the circle and explained in text.  
This example shows a general precaution for something that you must do.

## 4. Overview

This document describes the procedure for connecting the OMRON Safety Network Controller (NE1A series) to the OMRON NJ-series Machine Automation Controller (hereinafter referred to as the Controller) on DeviceNet and provides the procedure for checking their connection.

This document does not describe the safety functions. Refer to the *DeviceNet Safety Safety Network Controller Operation Manual* (Cat. No. Z906) for information on the safety functions and ensure the safety.

## 5. Applicable Devices and Support Software

### 5.1. Applicable Devices

The applicable devices are as follows:

Manufacturer	Name	Model
OMRON	NJ-series CPU Unit	NJ501-□□□□ NJ301-□□□□
OMRON	DeviceNet Unit (Master Unit)	CJ1W-DRM21
OMRON	Safety Network Controller	NE1A-SCPU01-V1



#### Precautions for Correct Use

As applicable devices above, the devices with the models and versions listed in Section 5.2. are actually used in this document to describe the procedure for connecting devices and checking the connection.

You cannot use devices with versions lower than the versions listed in Section 5.2.

To use the above devices with versions not listed in Section 5.2 or versions higher than those listed in Section 5.2, check the differences in the specifications by referring to the manuals before operating the devices.



#### Additional Information

This document describes the procedure to establish the network connection. Except for the connection procedure, it does not provide information on operation, installation or wiring method. It also does not describe the function or operation of the devices. Refer to the manuals or contact your OMRON representative.

**5.2. Device Configuration**

The hardware components to reproduce the connection procedure of this document are as follows:

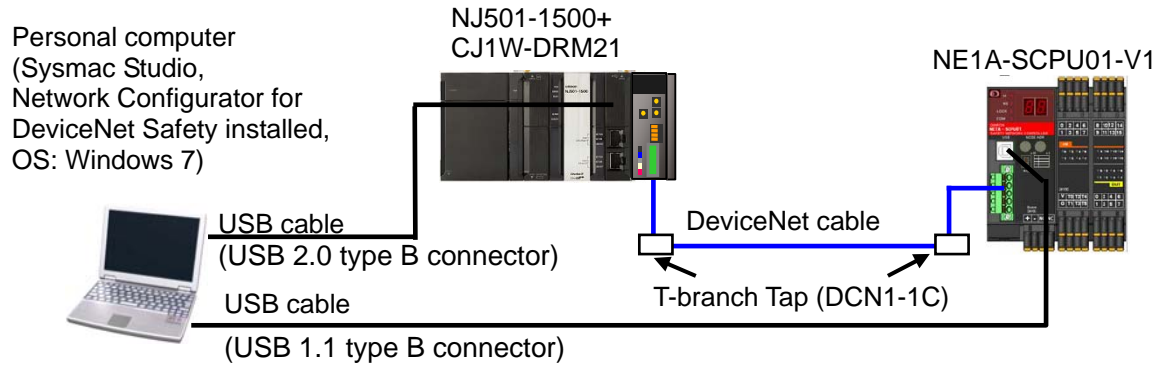

Manufacturer	Name	Model	Version
OMRON	DeviceNet Unit (Master Unit)	CJ1W-DRM21	Ver.1.1
OMRON	CPU Unit	NJ501-1500	Ver.1.03
OMRON	Power Supply Unit	NJ-PA3001	
OMRON	DeviceNet cable	DCA1-5C10	
OMRON	T-branch Tap	DCN1-1C	
OMRON	Sysmac Studio	SYSMAC-SE2[ ] [ ] [ ] [ ]	Ver.1.04
-	Personal computer (OS: Windows 7)	-	
-	USB cable (USB 2.0 type B connector)	-	
-	USB cable (USB 1.1 type B connector)	-	
OMRON	Safety Network Controller	NE1A-SCPU01-V1	
OMRON	Network Configurator for CIP Safety on DeviceNet	WS02-CFSC1-E	Ver.3.30

**Precautions for Correct Use**

Update the Sysmac Studio to the version specified in this section or higher version using the auto update function.

If a version not specified in this section is used, the procedures described in Section 7 and subsequent sections may not be applicable. In that case, use the equivalent procedures described in the Sysmac Studio Version 1 Operation Manual (Cat.No. W504).

**Additional Information**

For information on the DeviceNet cable and network wiring, refer to *Section 2 Network Configuration and Wiring* in the *DeviceNet Operation Manual* (Cat.No. W267).

Connect a terminating resistor to each end of the trunk line of DeviceNet.



### **Additional Information**

---

In this document, a USB is used to connect with the Controller. For information on how to install a USB driver, refer to *A-1 Driver Installation for Direct USB Cable Connection* of the *Sysmac Studio Version 1 Operation Manual* (Cat.No. W504).

---



## 6. DeviceNet Settings

This section provides specifications such as communications parameters and variables that are defined in this document.

### 6.1. DeviceNet Communications Settings

The following are the settings for DeviceNet.

	CJ1W-DRM21	NE1A-SCPU01-V1
Unit number	0	-
Node address (MAC ID)	63	0
Baud rate (bps)	500 kbps	500 kbps



#### Additional Information

To monitor the Safety Network Controller from the Controller, set the Controller as a Standard Master and set the Safety Network Controller as a Standard Slave on DeviceNet.

Establish a connection between the Standard Master and the Standard Slave to monitor the data. With the connection, not only Safety I/O communications but also standard I/O communications are performed.

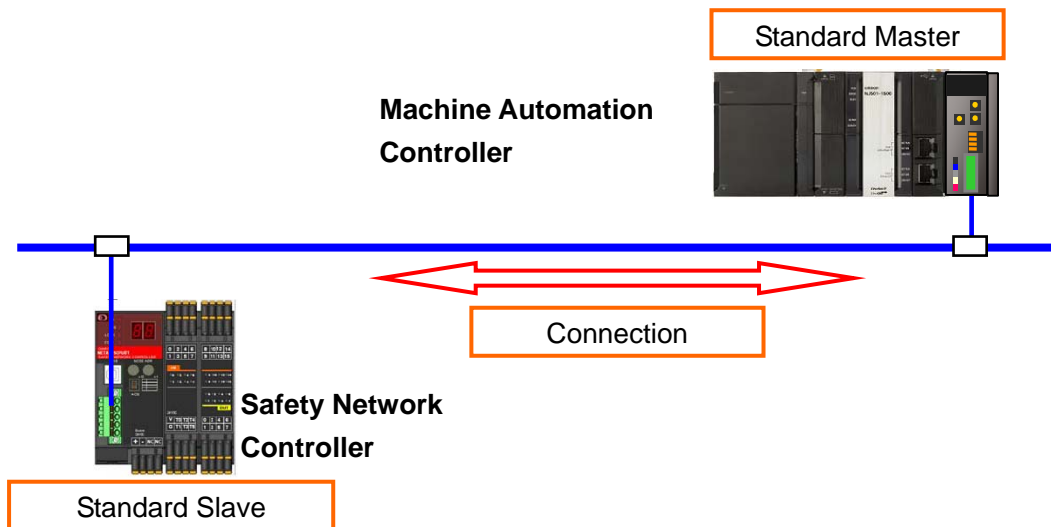

#### Additional Information

When a DeviceNet Unit is used with a Controller, slave data are allocated to the memory used for CJ-series Units. With programs, specify variable names for the memory used for CJ-series Units.

With Sysmac Studio, add the prefix "%" to each address to indicate the memory used for CJ-series Units.

## 6.2. Global Variable Table

The Controller accesses the remote I/O communications data as global variables. The following are the settings of the global variables. Register a global variable table with the Sysmac Studio.

Name	Data type	AT	Destination device allocation
DN00_Area2_OUT	WORD	%3200	User setting Area2 (bit 00 to 15) (2 bytes)
DN00_Status_IN	BOOL[32]	%3300	Status (4 bytes)
DN00_Area1_IN	WORD	%3302	User setting Area1 (bit 00 to 15) (2 bytes)

### ■ Status details

Variable name	Bit15 to Bit8	Bit7 to Bit0
DN00_Status_[15] to [0]	Local Input Status1	General Status
Variable name	Bit31 to Bit24	Bit23 to Bit16
DN00_Status_[31] to [16]	Local Output Status1	Local Input Status2

Status	Description
General Status	General status of the Safety Network Controller. e.g., Status of the voltage and communications.
Local Input Status1	Input terminal status of the Safety Network Controller. (Terminal No. 0 to 7)
Local Input Status2	Input terminal status of the Safety Network Controller. (Terminal No. 8 to 15)
Local Output Status	Output terminal status of the Safety Network Controller.

### • Description of the general status

Bit	Description	Bit	Description
Bit 0	Input Power Supply Voltage Status 0:Normal 1:Error or power supply is OFF	Bit 4	Safety I/O Communications Error Status 0:Normal 1:Error
Bit 1	Output Power Supply Voltage Status 0:Normal 1:Error or power supply is OFF	Bit 5	Safety I/O Communications Status 0:Error or communications stopped 1:Normal
Bit 2	Standard I/O Communications Status 0:Normal 1:Error	Bit 6	RUN Status 0:Idle Mode 1:RUN Mode

Bit	Description	Bit	Description
Bit 3	Standard I/O Communications Status 0:Error or communications stopped 1:Normal	Bit 7	Normal Status 0:Error 1:Normal



### Additional Information

Set the AT to the values in memory used for CJ-series Units, which were allocated to the slaves using the Network Configurator. With Sysmac Studio, add the prefix "%" to each address to indicate the memory used for CJ-series Units. To allocate a bit address, set the data type to BOOL and set the AT to %3200.00 as shown below.

Name	Data type	AT	Destination device allocation
DN00_OUT_Bit00	BOOL	%3200.00	Bit 00 Output
:			
DN00_OUT_Bit15	BOOL	%3200.15	Bit 15 Output
DN00_IN_Bit00	BOOL	%3300.00	Bit 00 Input
:			
DN00_IN_Bit15	BOOL	%3300.15	Bit 15 Input



### Additional Information

You can assign the same address to more than one variable. However, this is not recommended as it reduces readability and makes the program more difficult to debug. If you do this, set an initial value for only one of the variables. If you set a different initial value for each individual variable, the initial value is not stable.



### Additional Information

With the Sysmac Studio, the data type is expressed as ARRAY[0..2] OF WORD when an array is specified for a data type. However, the data type of an array is simplified in this document (e.g. WORD[3]).

It is possible to set either of the following to specify an array for a data type with the Sysmac Studio.

- ARRAY[0..2]OF WORD
- WORD[3]

In the example above, 3 WORD array elements are secured.

## 7. Connection Procedure

This section describes how to connect the Controller to the Safety Network Controller on DeviceNet.

This document explains the procedures for setting up the Controller and the Safety Network Controller from the factory default setting. For the initialization, refer to *Section 8 Initialization Method*.

### 7.1. Overview of Setting Up Remote I/O Communications

The following shows the relationship of processes to operate remote I/O communications.

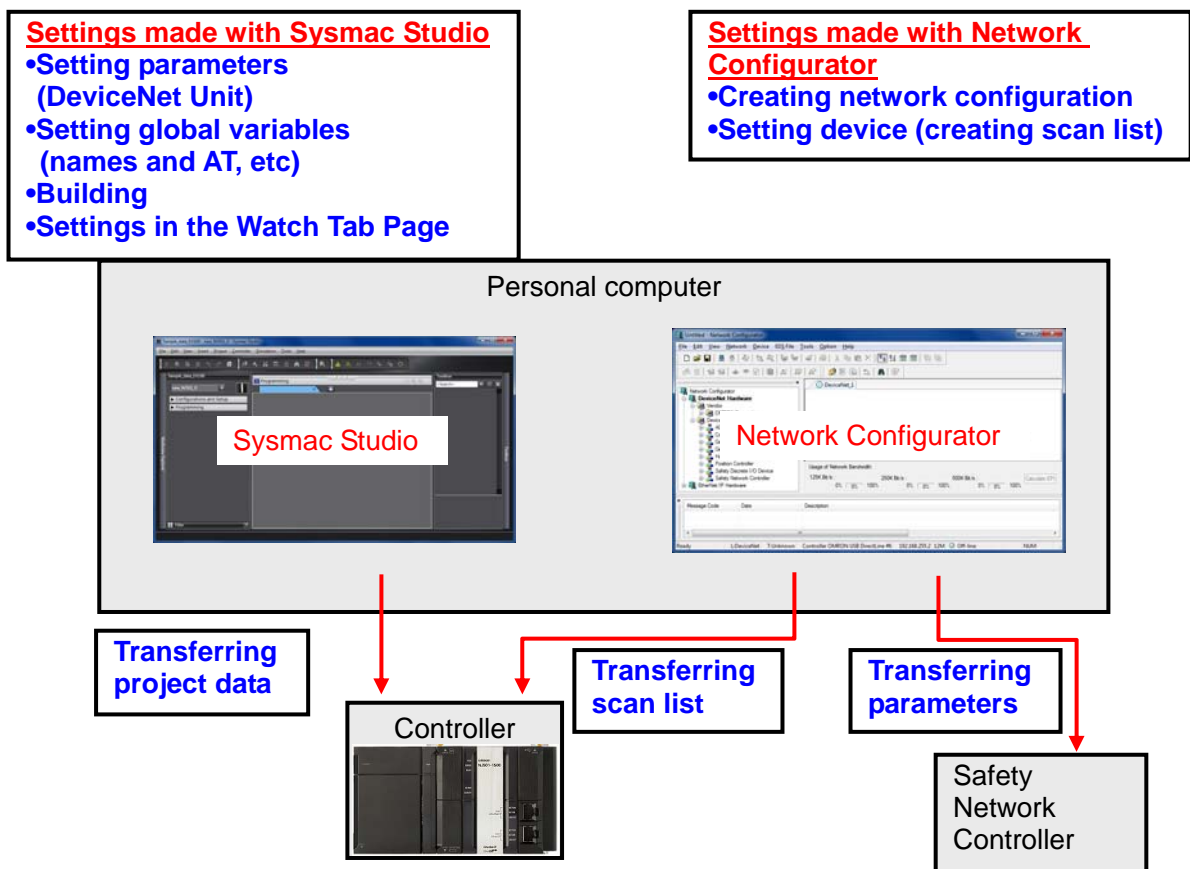

## 7.2. Work Flow

Take the following steps to make the connection settings for remote I/O communications of DeviceNet.

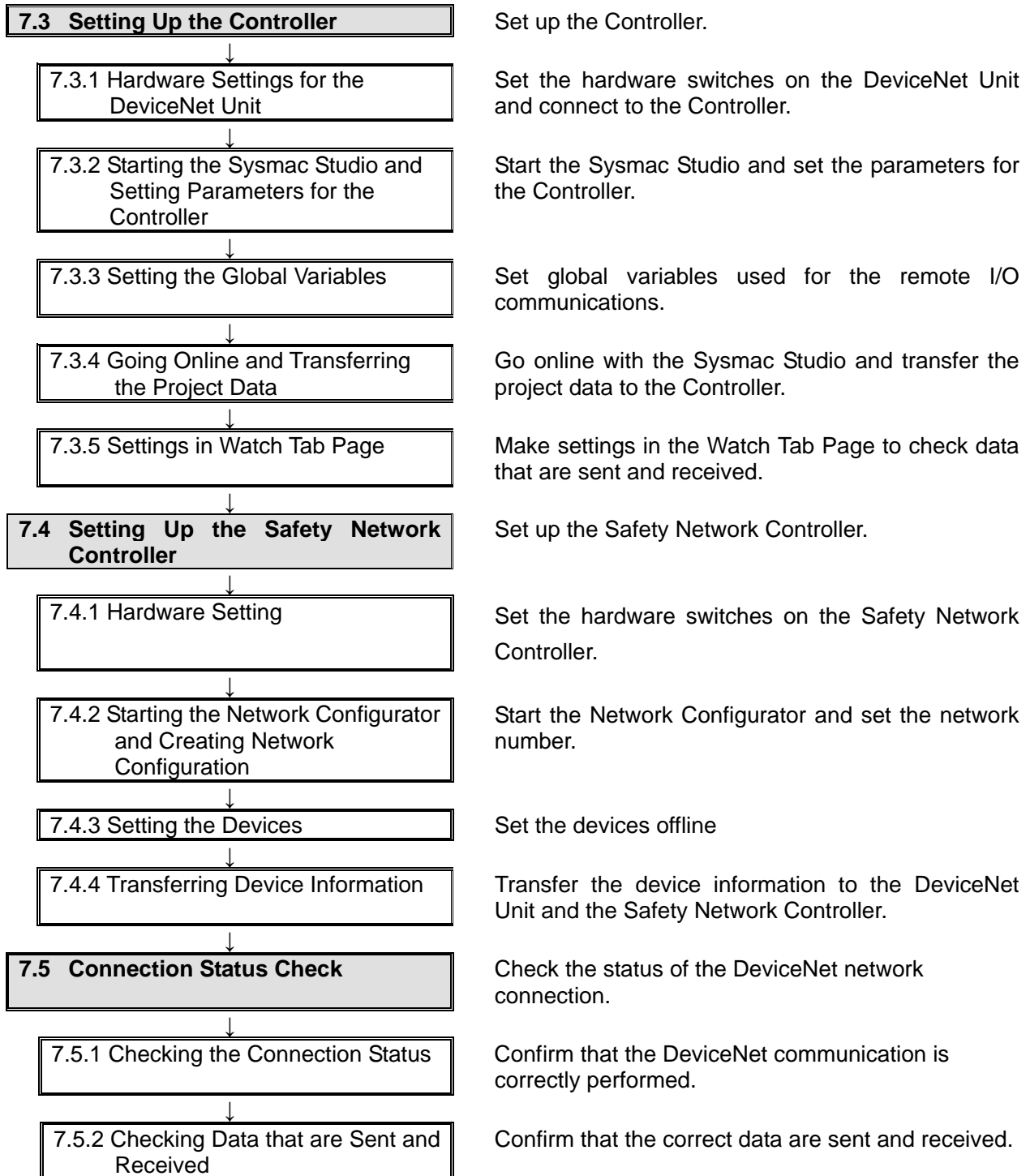

### 7.3. Setting Up the Controller

Set up the Controller.

#### 7.3.1. Hardware Settings for the DeviceNet Unit

Set the hardware switches on the DeviceNet Unit and connect to the Controller.



#### Precautions for Correct Use

Make sure that the power supply is OFF when you perform the setting up.

- 1 Make sure that the power supply to the Controller is OFF when you perform setting up.

\*If the power supply is turned ON, settings may not be applicable as described in the following procedure.

- 2 Check the hardware switches on the front panel of the DeviceNet Unit by referring to the figure on the right.

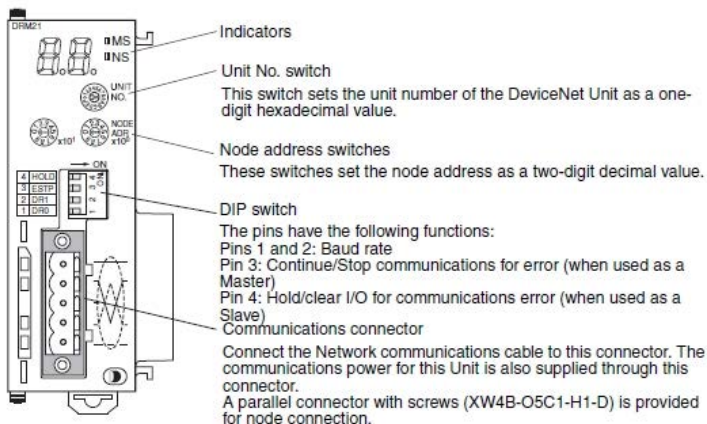

- 3 Set the Unit No. Switch to 0.



Setting method: One-digit hexadecimal

Setting range: 0 to F

Note: The unit number is set to 0 at the factory.

- 4 Set the Node Address Switches to 63.



Setting method: Two-digit decimal

Setting range: 0 to 63

Note: The node address is set to 63 at the factory.

5 Set pin 2 of the DIP switch to ON. (Set pins 1, 3 and 4 of the DIP switch to OFF.)

\*Set the baud rate to 500 kbps.

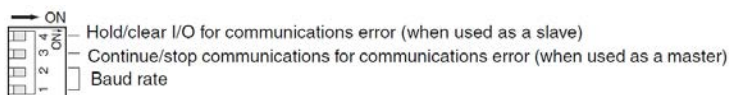

Pin	Function	Setting
1	Baud rate	See the next table.
2		
3	Continue/stop remote I/O communications for communication errors (when used as a master)	OFF: Continue communications ON: Stop communications
4	Hold/clear remote outputs for communications error (when used as a slave)	OFF: Clear remote outputs ON: Hold remote outputs

Pin 1	Pin 2	Baud rate
OFF	OFF	125 kbps
ON	OFF	250 kbps
OFF	ON	500 kbps
ON	ON	Not allowed.

All pins are set to OFF at the factory.

6 Connect the DeviceNet Unit to the Controller.  
Connect the personal computer, Safety Network Controller and Controller using the DeviceNet cable and USB cable as shown in 5.2 Device Configuration.  
Turn ON the power supply to the Controller and DeviceNet.

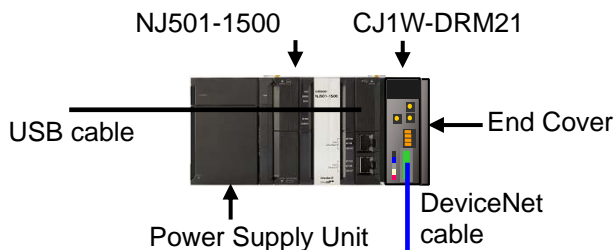

**Additional Information**

DeviceNet cables, please cut to the length you want to use.

For details on communications specifications and wiring, refer to 2-4 *Wiring Methods* in the *DeviceNet OPERATION MANUAL* (Cat. No. W267).

7.3.2. Starting the Sysmac Studio and Setting Parameters for the Controller

Start the Sysmac Studio and set the parameters for the Controller.

1 Start the Sysmac Studio.  
Click the **New Project** Button.

\*If a dialog box is displayed at start confirming the access right, select an option to start.

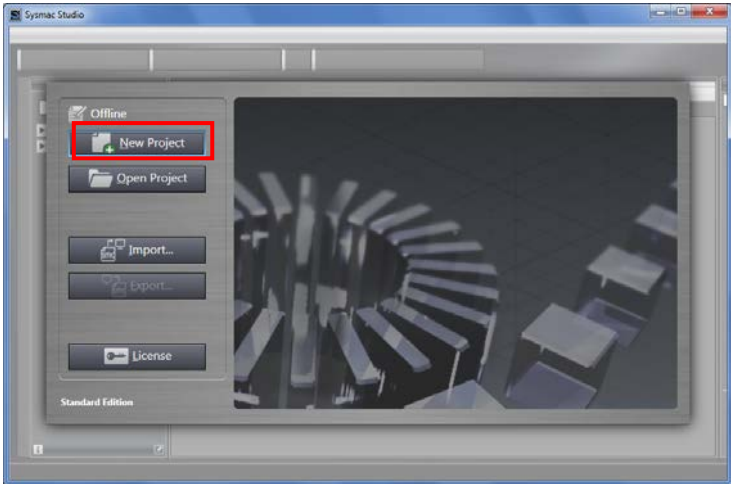

2 The Project Properties Dialog Box is displayed.  
\*In this document, New Project is set as the project name.

Confirm that the Category and Device to use are set in the Select Device Field.

Select 1.03 from the Version pull-down list.

\*Although version 1.03 is selected in this document, select the version you actually use.

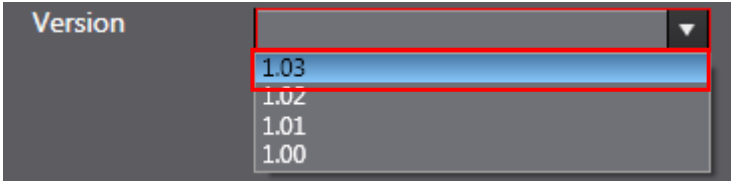
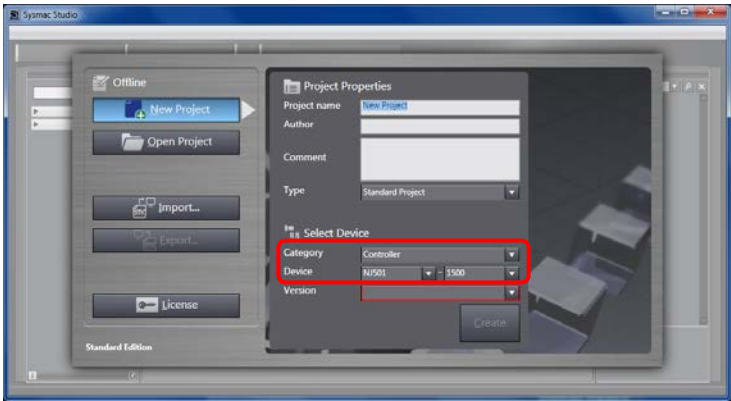

3 Click the **Create** Button.

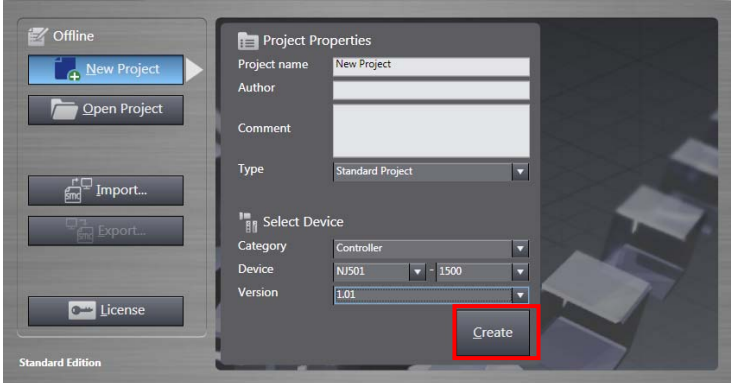



4 The new project is displayed. The left pane is called Multiview Explorer, the right pane is called Toolbox and the middle pane is called Edit Pane.

The screenshot shows the software interface with three panes. The left pane is labeled 'Multiview Explorer', the middle pane is labeled 'Edit Pane', and the right pane is labeled 'Toolbox'. Red arrows point from the text labels to the corresponding panes in the screenshot.

5 Double-click **CPU/Expansion Racks** under **Configurations and Setup** in the Multiview Explorer. The CPU/Expansion Racks Tab is displayed on the Edit Pane.

The screenshot shows the 'New Project' dialog box on the left and the 'Configurations and Setup' dialog box on the right. In the 'Configurations and Setup' dialog, the 'CPU/Expansion Racks' tab is selected and highlighted with a red circle. The 'CPU/Expansion Racks' folder is also highlighted with a red box in the Multiview Explorer.

6 Select **Communications** under Category in the Toolbox. Select CJ1W-DRM21. Right-click **CJ1W-DRM21**. Select **Insert** from the menu that is displayed. CJ1W-DRM21 Unit is displayed as shown in the figure on the right.

The first screenshot shows the 'Category' list in the Toolbox with 'Communications' selected. The 'CJ1W-DRM21' unit is selected in the 'Input Keyword' list. A red arrow points to the 'Insert' button in the context menu. The second screenshot shows the 'CPU/Expansion Racks' configuration with the 'CJ1W-DRM21' unit inserted into slot 0. The 'Unit No.' field in the configuration table is highlighted with a red box.

Item name	Value
Device name	J01
Model name	CJ1W-DRM21
Product name	DeviceNet Mas...
Specifications	Master/slave, 3...
Rack No.	0
Slot No.	0
Unit No.	0
Special Unit Setti...	Settings
	Edit Special Uni

7 Enter 0 in the Unit No. Field.

The screenshot shows the configuration table with the 'Unit No.' field set to 0. The 'Unit No.' field is highlighted with a red box.

Item name	Value
Device name	J01
Model name	CJ1W-DRM21
Product name	DeviceNet Master Unit
Specifications	Master/slave, 32000 point...
Rack No.	0
Slot No.	0
Unit No.	0
Special Unit Settings	Settings
	Edit Special Unit Settings

7.3.3. Setting Global Variables

Set global variables used for the remote I/O communications.

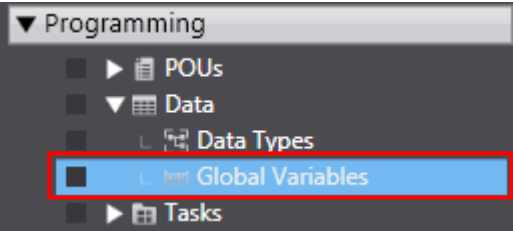
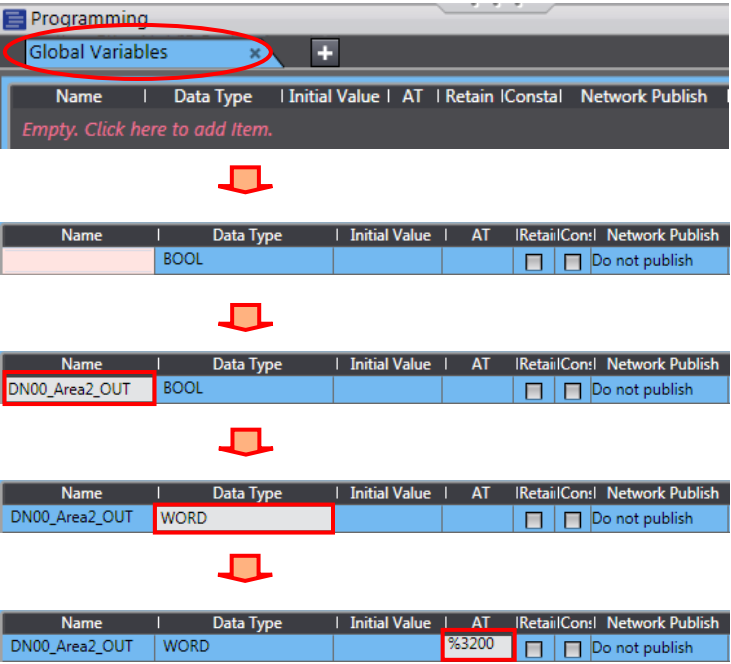
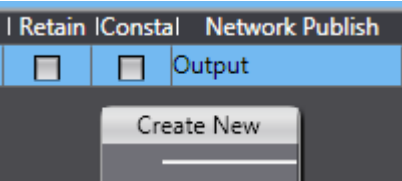
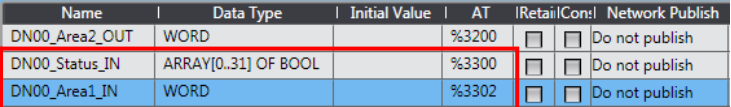
<p>1</p>	<p>Double-click <b>Global variables</b> under <b>Programming - Data</b> in the Multiview Explorer.</p>																																											
<p>2</p>	<p>The Global Variables Tab is displayed in the Multiview Explorer. Click a column under Name to enter a new variable.  Enter <i>DN00_Area2_OUT</i> in the Name Column.  Enter WORD in the Data Type Column.  Enter %3200 in the AT Column.</p>	 <p>The screenshot shows the 'Global Variables' tab with a table. The first step shows an empty table with a red box around the 'Name' column header. The second step shows the table with 'DN00_Area2_OUT' entered in the 'Name' column and 'BOOL' in the 'Data Type' column. The third step shows 'WORD' entered in the 'Data Type' column. The fourth step shows '%3200' entered in the 'AT' column. Red arrows indicate the sequence of steps.</p> <table border="1" data-bbox="710 817 1444 869"> <thead> <tr> <th>Name</th> <th>Data Type</th> <th>Initial Value</th> <th>AT</th> <th>IRetail</th> <th>Consl</th> <th>Network Publish</th> </tr> </thead> <tbody> <tr> <td></td> <td>BOOL</td> <td></td> <td></td> <td><input type="checkbox"/></td> <td><input type="checkbox"/></td> <td>Do not publish</td> </tr> </tbody> </table> <table border="1" data-bbox="710 940 1444 992"> <thead> <tr> <th>Name</th> <th>Data Type</th> <th>Initial Value</th> <th>AT</th> <th>IRetail</th> <th>Consl</th> <th>Network Publish</th> </tr> </thead> <tbody> <tr> <td>DN00_Area2_OUT</td> <td>WORD</td> <td></td> <td></td> <td><input type="checkbox"/></td> <td><input type="checkbox"/></td> <td>Do not publish</td> </tr> </tbody> </table> <table border="1" data-bbox="710 1064 1444 1115"> <thead> <tr> <th>Name</th> <th>Data Type</th> <th>Initial Value</th> <th>AT</th> <th>IRetail</th> <th>Consl</th> <th>Network Publish</th> </tr> </thead> <tbody> <tr> <td>DN00_Area2_OUT</td> <td>WORD</td> <td></td> <td>%3200</td> <td><input type="checkbox"/></td> <td><input type="checkbox"/></td> <td>Do not publish</td> </tr> </tbody> </table>	Name	Data Type	Initial Value	AT	IRetail	Consl	Network Publish		BOOL			<input type="checkbox"/>	<input type="checkbox"/>	Do not publish	Name	Data Type	Initial Value	AT	IRetail	Consl	Network Publish	DN00_Area2_OUT	WORD			<input type="checkbox"/>	<input type="checkbox"/>	Do not publish	Name	Data Type	Initial Value	AT	IRetail	Consl	Network Publish	DN00_Area2_OUT	WORD		%3200	<input type="checkbox"/>	<input type="checkbox"/>	Do not publish
Name	Data Type	Initial Value	AT	IRetail	Consl	Network Publish																																						
	BOOL			<input type="checkbox"/>	<input type="checkbox"/>	Do not publish																																						
Name	Data Type	Initial Value	AT	IRetail	Consl	Network Publish																																						
DN00_Area2_OUT	WORD			<input type="checkbox"/>	<input type="checkbox"/>	Do not publish																																						
Name	Data Type	Initial Value	AT	IRetail	Consl	Network Publish																																						
DN00_Area2_OUT	WORD		%3200	<input type="checkbox"/>	<input type="checkbox"/>	Do not publish																																						
<p>3</p>	<p>After entering, right-click and select <b>Create New</b> from the menu.</p>																																											
<p>4</p>	<p>Enter the following data in the new columns in the same way as steps 2 and 3.</p> <ul style="list-style-type: none"> <li>•Name: DN00_Status_IN Data Type: BOOL[32] AT: %3300</li> <li>*After entering, ARRAY[0..31] OF BOOL is displayed as shown on the right figure.</li> <li>•Name: DN00_Area1_IN Data Type: WORD AT: %3302</li> </ul>	 <table border="1" data-bbox="710 1541 1444 1646"> <thead> <tr> <th>Name</th> <th>Data Type</th> <th>Initial Value</th> <th>AT</th> <th>IRetail</th> <th>Consl</th> <th>Network Publish</th> </tr> </thead> <tbody> <tr> <td>DN00_Area2_OUT</td> <td>WORD</td> <td></td> <td>%3200</td> <td><input type="checkbox"/></td> <td><input type="checkbox"/></td> <td>Do not publish</td> </tr> <tr> <td>DN00_Status_IN</td> <td>ARRAY[0..31] OF BOOL</td> <td></td> <td>%3300</td> <td><input type="checkbox"/></td> <td><input type="checkbox"/></td> <td>Do not publish</td> </tr> <tr> <td>DN00_Area1_IN</td> <td>WORD</td> <td></td> <td>%3302</td> <td><input type="checkbox"/></td> <td><input type="checkbox"/></td> <td>Do not publish</td> </tr> </tbody> </table>	Name	Data Type	Initial Value	AT	IRetail	Consl	Network Publish	DN00_Area2_OUT	WORD		%3200	<input type="checkbox"/>	<input type="checkbox"/>	Do not publish	DN00_Status_IN	ARRAY[0..31] OF BOOL		%3300	<input type="checkbox"/>	<input type="checkbox"/>	Do not publish	DN00_Area1_IN	WORD		%3302	<input type="checkbox"/>	<input type="checkbox"/>	Do not publish														
Name	Data Type	Initial Value	AT	IRetail	Consl	Network Publish																																						
DN00_Area2_OUT	WORD		%3200	<input type="checkbox"/>	<input type="checkbox"/>	Do not publish																																						
DN00_Status_IN	ARRAY[0..31] OF BOOL		%3300	<input type="checkbox"/>	<input type="checkbox"/>	Do not publish																																						
DN00_Area1_IN	WORD		%3302	<input type="checkbox"/>	<input type="checkbox"/>	Do not publish																																						

### 7.3.4. Going Online and Transferring the Project Data

Go online with the Sysmac Studio and transfer the project data to the Controller.

After transfer, reset the Controller.

## WARNING

Always confirm safety at the destination node before you transfer a user program, configuration data, setup data, device variables, or values in memory used for CJ-series Units from the Sysmac Studio.

The devices or machines may perform unexpected operation regardless of the operating mode of the CPU Unit.



## Caution

Always confirm safety before you reset the Controller or any components.

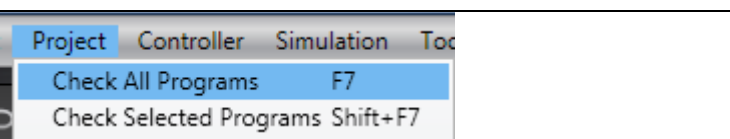
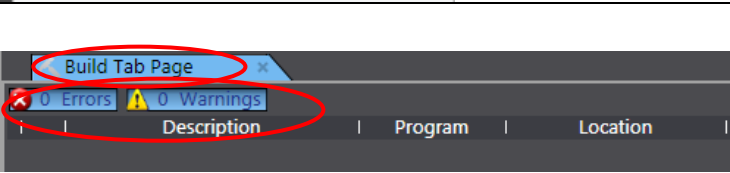
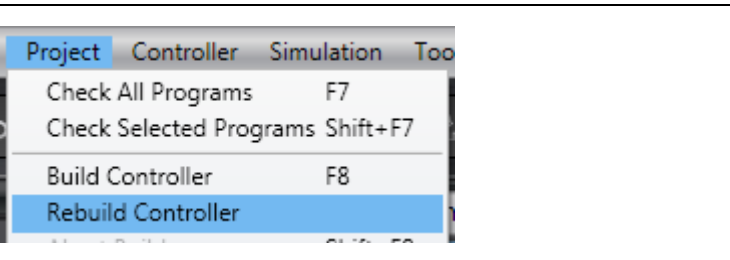
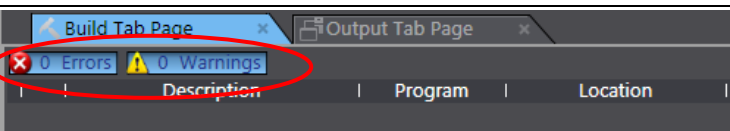
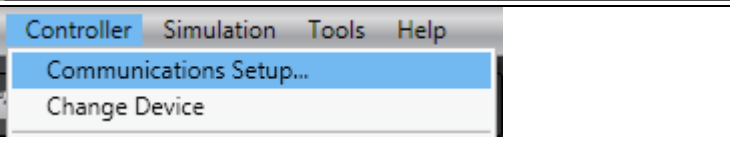

1	Select <b>Check All Programs</b> from the Project Menu.	
2	The Build Tab Page is displayed in the Edit Pane. Confirm that "0 Errors" and "0 Warnings" are displayed.	
3	Select <b>Rebuild Controller</b> from the Project Menu.	
4	Confirm that "0 Errors" and "0 Warnings" are displayed in the Build Tab Page.	
5	Select <b>Communications Setup</b> from the Controller Menu.	

6 The Communications Setup Dialog Box is displayed. Select the *Direct connection via USB* Option for Connection Type. Click the **OK** Button.

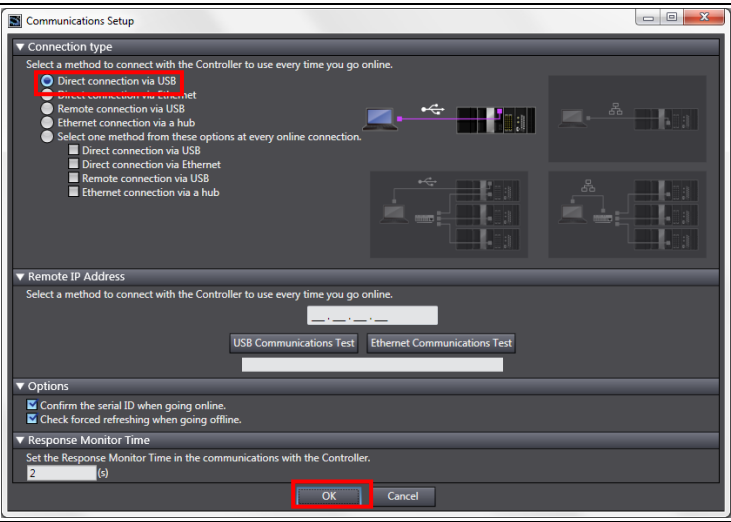

7 Select **Online** from the Controller Menu. A confirmation dialog is displayed. Click the **Yes** Button.   
 \*A displayed dialog depends on the status of the Controller used. Click the **Yes** Button to proceed with the processing.

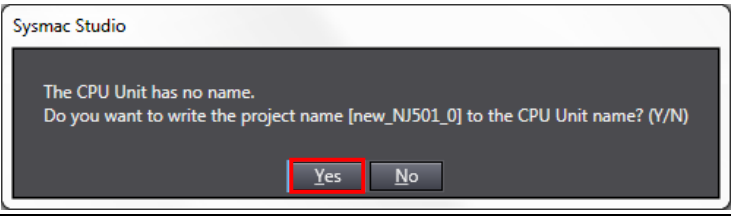
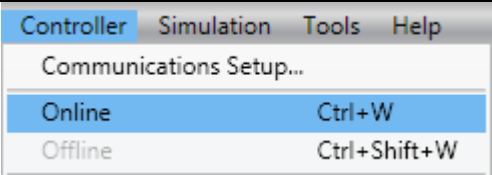

8 When an online connection is established, a yellow bar is displayed on the top of the Edit Pane.



**Additional Information**

For details on the online connections to a Controller, refer to *Section 5 Going Online with a Controller* in the *Sysmac Studio Version 1 Operation Manual (Cat. No. W504)*.

9 Select **Synchronization** from the Controller Menu.

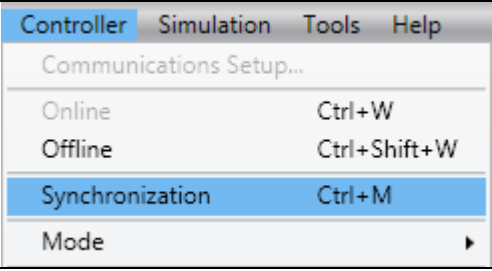

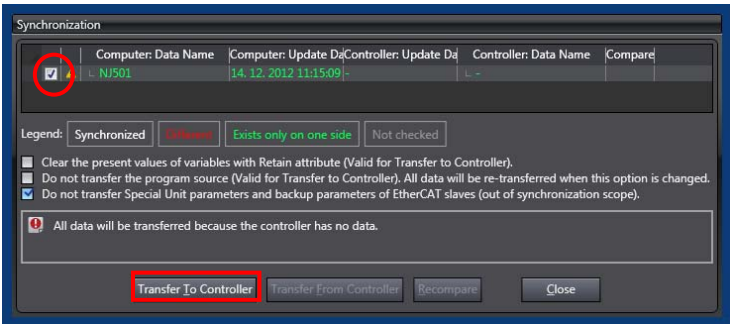
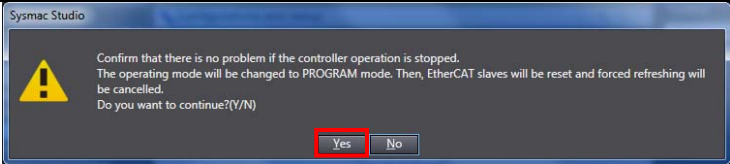
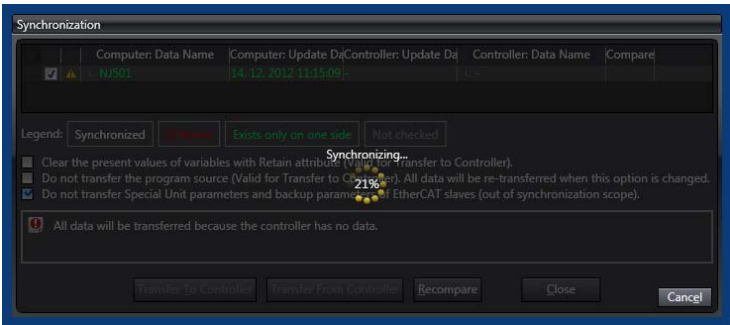
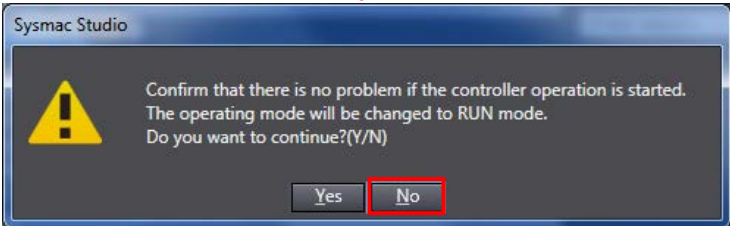
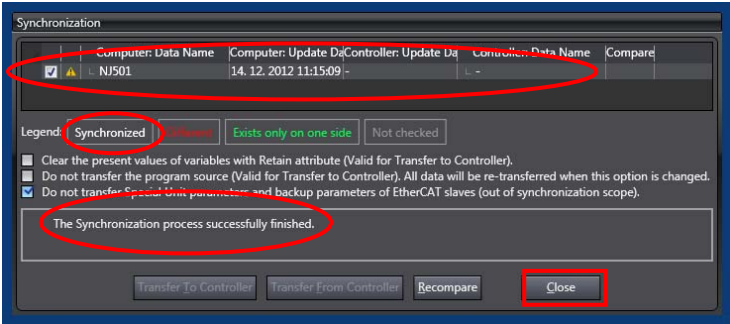
- 10 The Synchronization Dialog Box is displayed.  
Confirm that the data to transfer (NJ501 in the right figure) is selected. Then, click the **Transfer to Controller** Button.
- 
- 11 A confirmation dialog is displayed. Click the **Yes** Button.
- A screen stating "Synchronizing" is displayed.
- 
- 
- A confirmation dialog box is displayed. Click the **No** Button.
- 
- 12 Confirm that the synchronized data is displayed with the color specified by "Synchronized", and that a message is displayed stating "The synchronization process successfully finished". If there is no problem, click the **Close** Button.
- 



**Additional Information**

If the synchronization fails, referring to the message that is displayed, please take appropriate action. For details, refer to *10-3 Error Messages for Sysmac Studio Operation* in the *Sysmac Studio Version 1 Operation Manual* (Cat. No. W504).

13 Select **Reset Controller** from the Controller Menu.

\*When Mode is set to RUN Mode, Reset Controller cannot be selected. In this case, select **Mode - PROGRAM Mode** from the Controller Menu to change to PROGRAM mode and follow the procedure in this step.



14 A confirmation dialog box is displayed several times. Click the **Yes** Button.

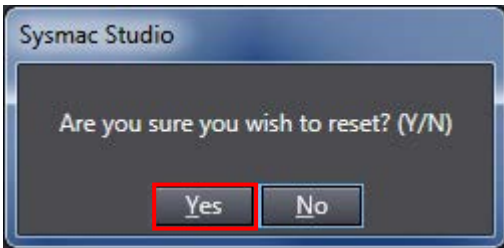
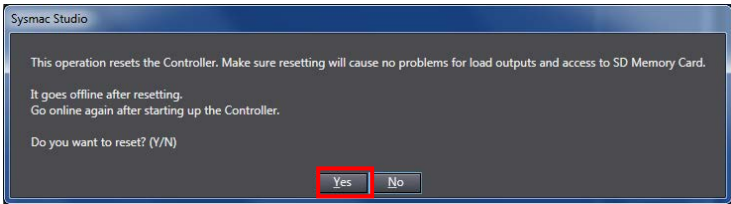

15 The controller is reset, and Sysmac Studio goes offline. The yellow bar on the top of the Edit Pane disappears. Go online by using steps 7 to 8.

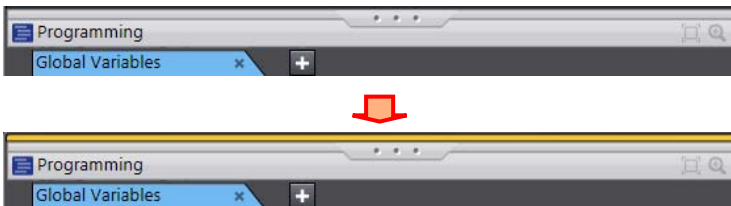

7.3.5. Settings in the Watch Tab Page

Make settings in the Watch Tab Page to check data that are sent and received.

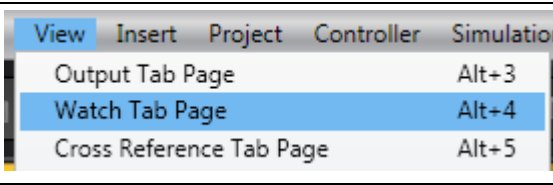
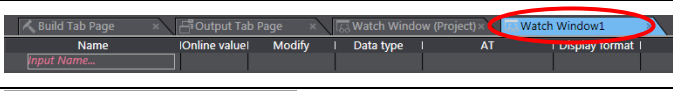
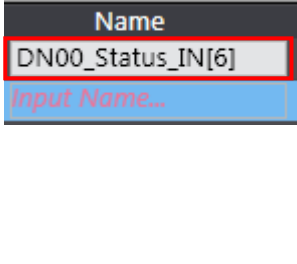
1	Select <b>Watch Tab Page</b> from the View Menu.	
2	The Watch Tab Page is displayed in the lower section of the Edit Pane.	
3	Enter the following name to monitor in the Name Column on the Watch Tab Page 1. To enter a new name, click the column stating <i>Input Name</i> . DN00_Status_IN[6]	

## 7.4. Setting Up the Safety Network Controller

Set up the Safety Network Controller.

### 7.4.1. Hardware Setting

Set the hardware switches on the Safety Network Controller.



#### Precautions for Correct Use

Make sure that the power supply is OFF when you perform the setting up.

- 1 Check the hardware switches on the Safety Network Controller by referring to the figure on the right.

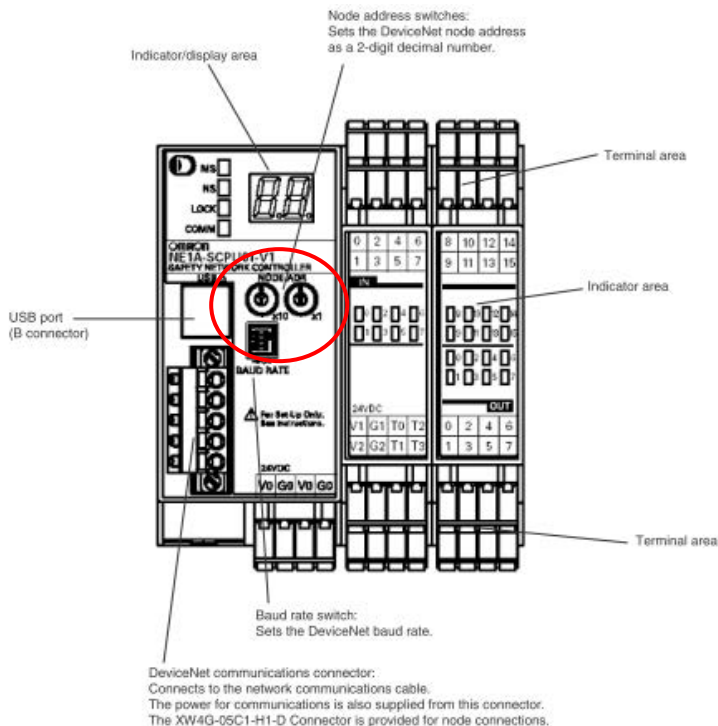

- 2 Set the Node Address Switches X10 and X1 to 0.

\*Set the node address to 0.

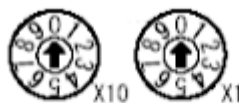

Method	Two-digit decimal number
Range	0 to 63

**Note** The node address is set to 63 at the factory.

- 3 Set pin 1 of the DIP switch to OFF and pin 2 of the DIP switch to ON.

\*Set the baud rate to 500 kbps.

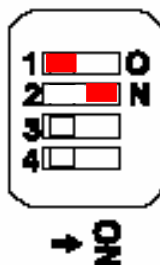



- 4 To connect the DeviceNet Unit, connect the DeviceNet cable to the DeviceNet connector on the Safety Network Controller.

Connect the Safety Network Controller to the personal computer using the USB cable.

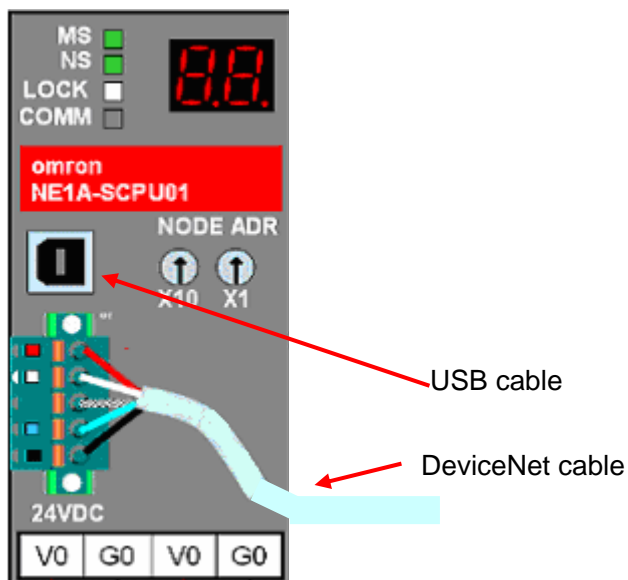

- 5 Connect the 24 VDC power supply to the Safety Network Controller.  
Connect the 24 VDC power supply to the DeviceNet cable.

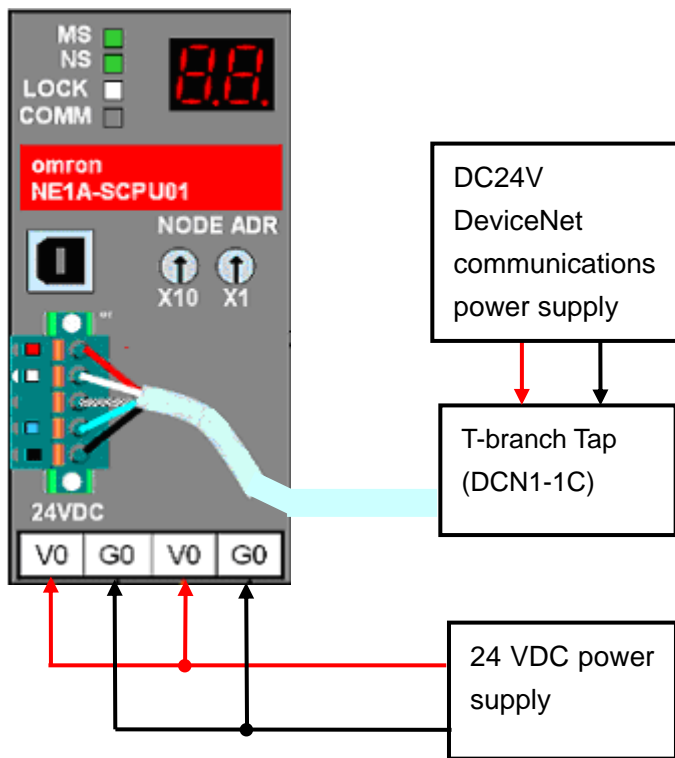

**Additional Information**

DeviceNet cables, please cut to the length you want to use.

For details on communications specifications and wiring, refer to *2-4 Wiring Methods* in the *DeviceNet OPERATION MANUAL* (Cat. No. W267).

7.4.2. Starting the Network Configurator and Creating the Network Configuration

Start the Network Configurator and create the network configuration.



**Additional Information**

To use the Safety Network Controller, Network Configurator for Safety (WS02-CFSC1-E) is required. When the Network Configurator for Safety is installed, Network Configurator provided with Sysmac Studio is overwritten.

When the Network Configurator for Safety is installed, the default network of the Network Configurator changes from EtherNet/IP to DeviceNet.

1 Turn ON the power supply to the Safety Network Controller.

2 Start the Network Configurator by selecting OMRON Network Configurator for CIP Safty v3 - Network Configurator from the Windows Menu.

\*The menu names are the default names at installation. After installing the Network Configurator for Safety, the same menu names are also displayed when starting the Network Configurator that was installed with the Sysmac Studio.

The screen on the right is displayed.

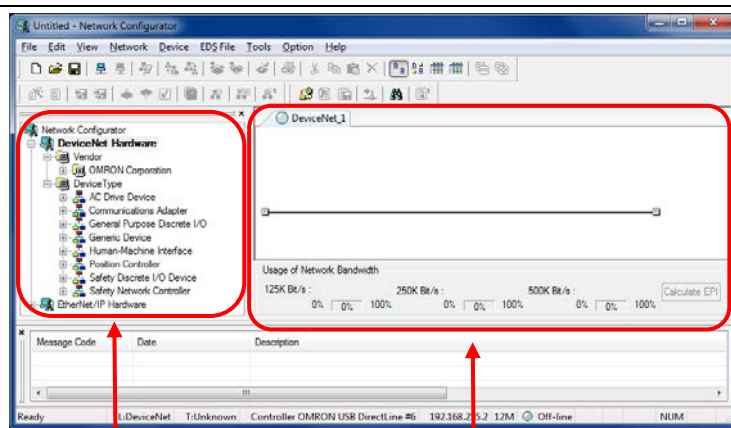

Hardware List

Network Configuration Pane

3 Select **New - DeviceNet** from the File Menu.

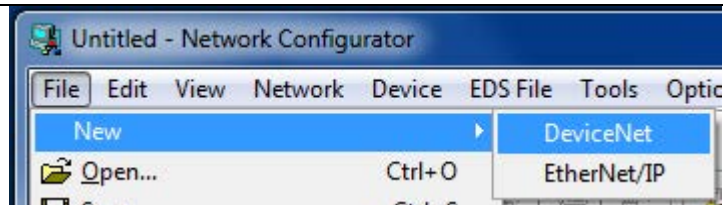

4 On the Hardware List, right-click **Rev1** under Device Type - Safety Network Controller - NE1A-SCPU01-V1.

Select **Add to Network**.

\*The device differs depending on the version of the Safety Network Controller used.

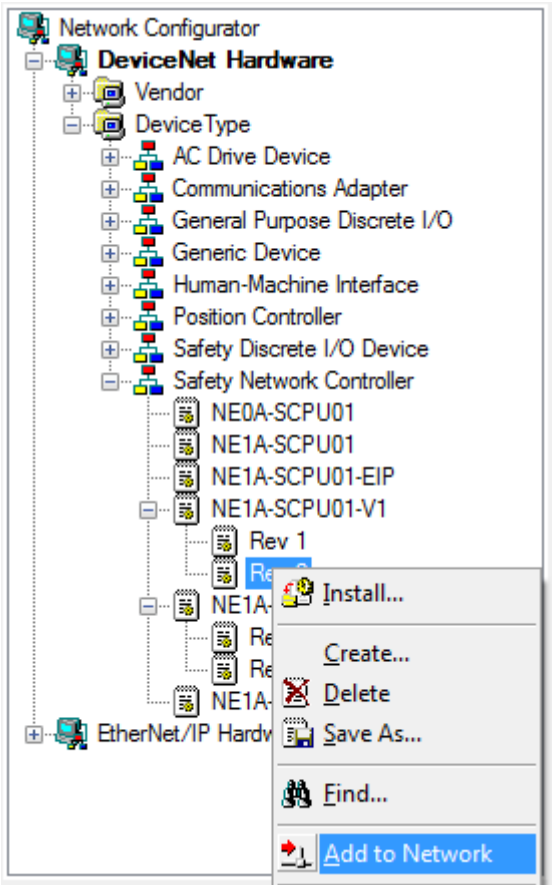

The Safety Network Controller icon is displayed. Confirm the displayed node address is 00.

\*If the value is different, change the value using the same procedure as steps 6 and 7.

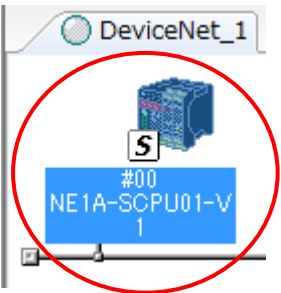

5 On the Hardware List, right-click **CJ1W-DRM21** under Device Type - Communications Adapter.

Select **Add to Network**.

CJ1W-DRM21 is added to the network.

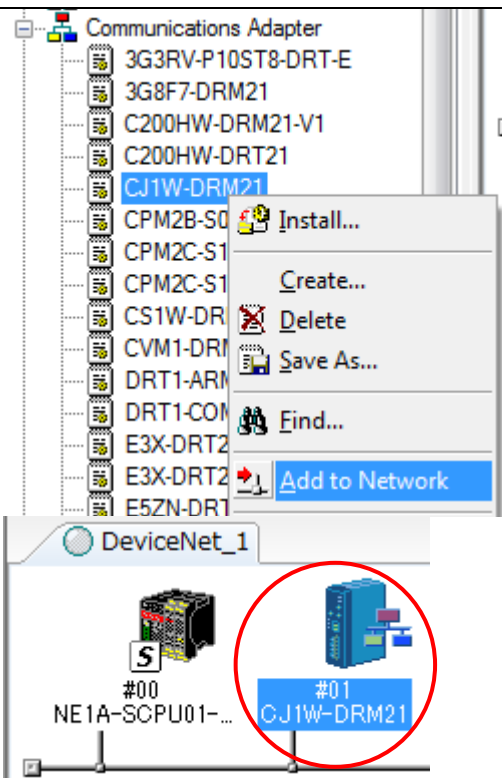

6 Right-click CJ1W-DRM21 and select **Change Node Address**.

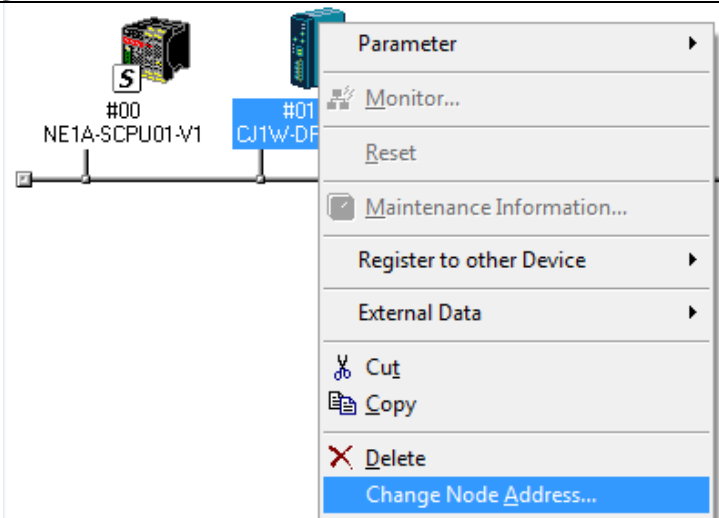

7 Enter 63 and click the **OK** Button.

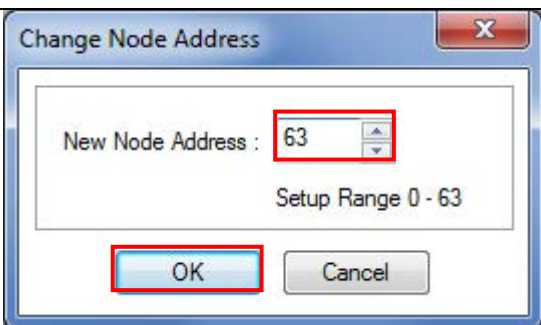

8 The node address is changed to 63.

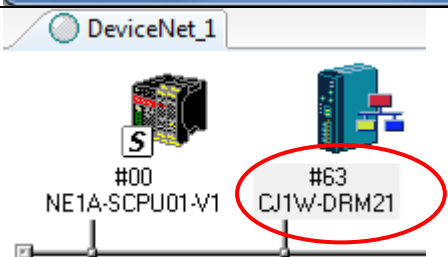

7.4.3. Setting the Device

Set the device offline.

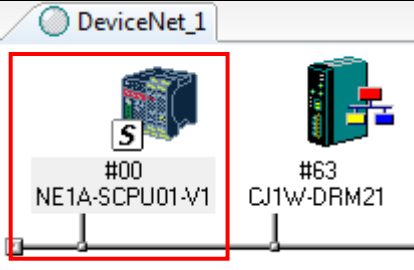
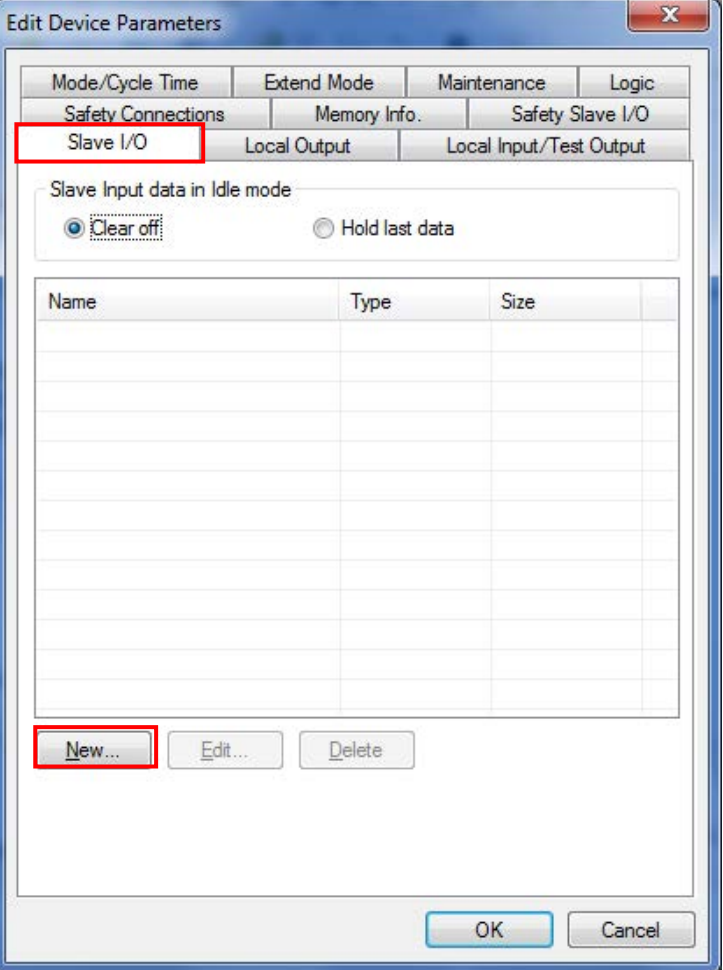
<p>1 Double-click the Safety Network Controller.</p>	
<p>2 The Edit Device Parameters Dialog Box is displayed.  Select the Slave I/O Tab Page and click the <b>New</b> Button.</p>	

3 The Edit Slave I/O Dialog Box is displayed.  
Select the *Poll* Option and then select the IN Tab.  
Click the **New** Button.

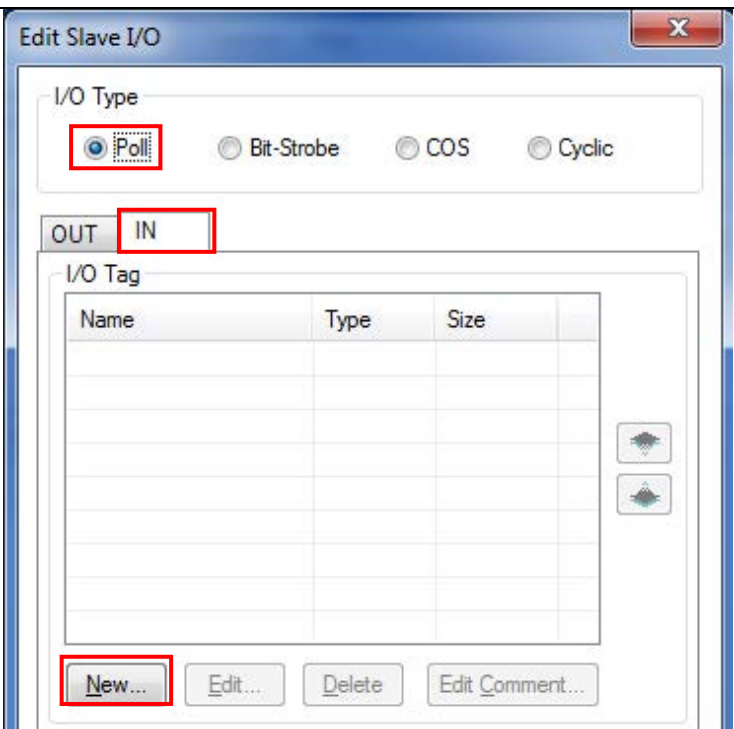

4 On the Edit I/O Tag Dialog Box, select the *WORD* Option and enter Area1 in the Name Field.  
  
Click the **OK** Button.

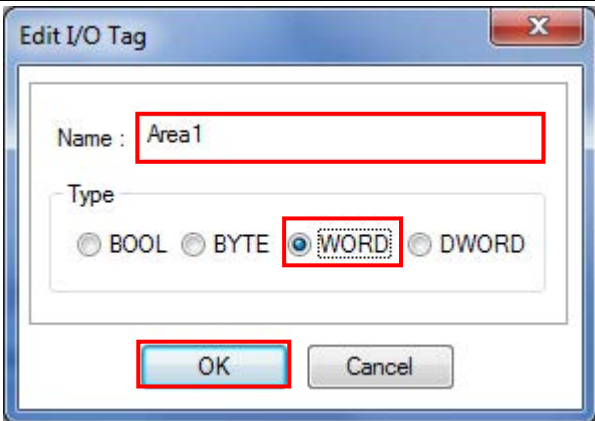

5 Area1 is displayed in the I/O Tag Field.

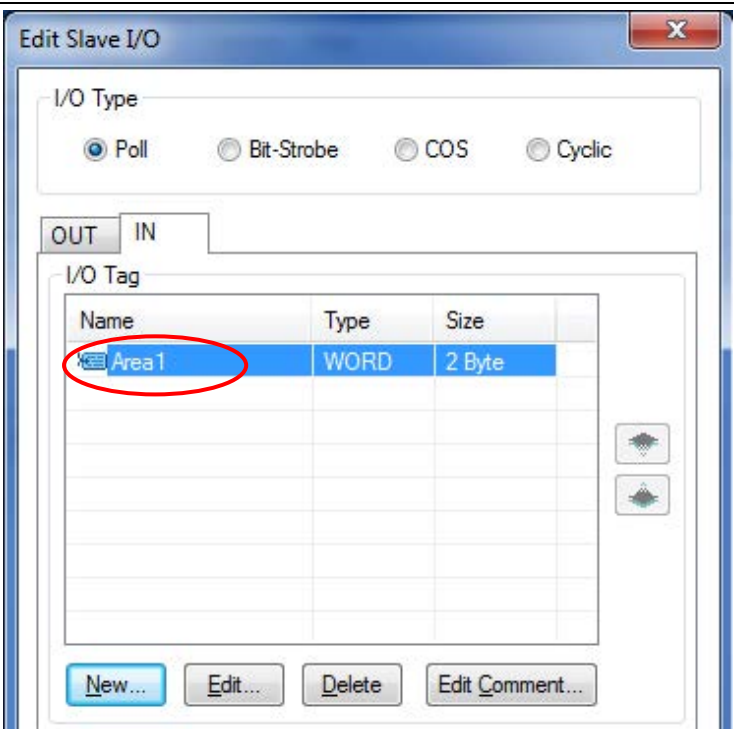

6 In the IN Tab Page, select the *General Status* Check Box, *Local Input Status* Check Box, and *Local Output Status* Check Box from the Status Field.

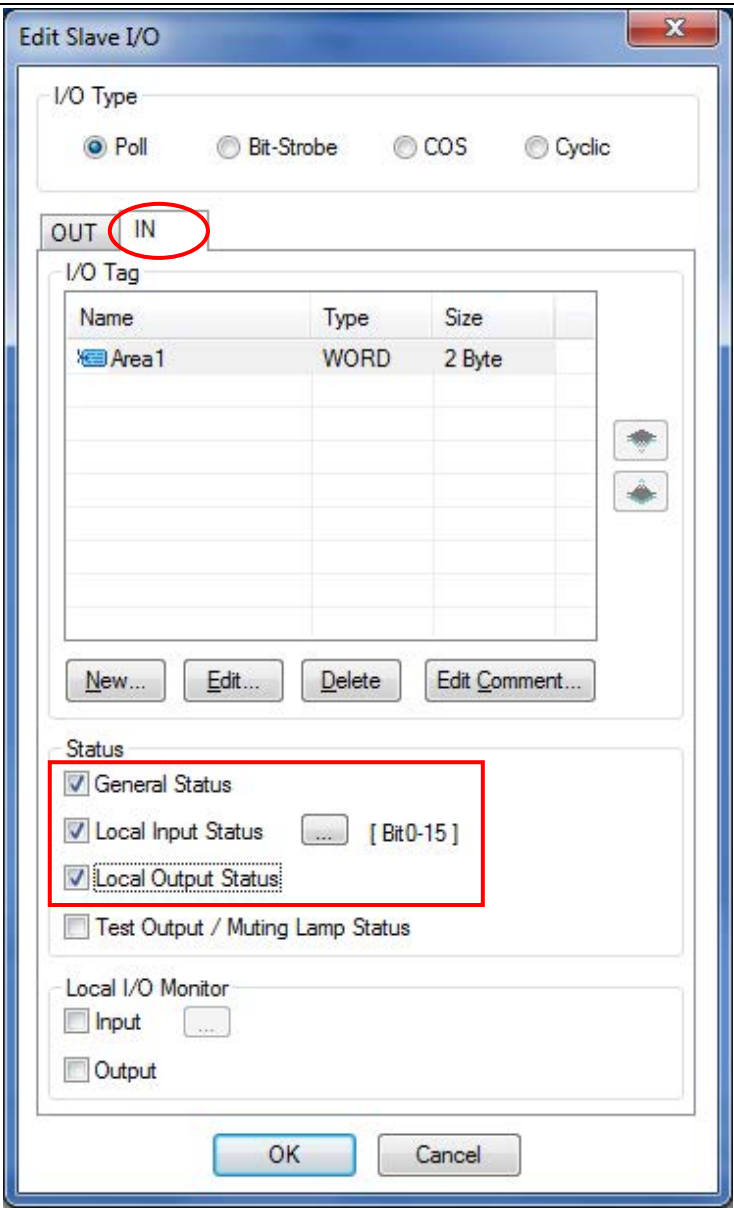

- 7 Select the OUT Tab Page.  
Click the **New** Button.

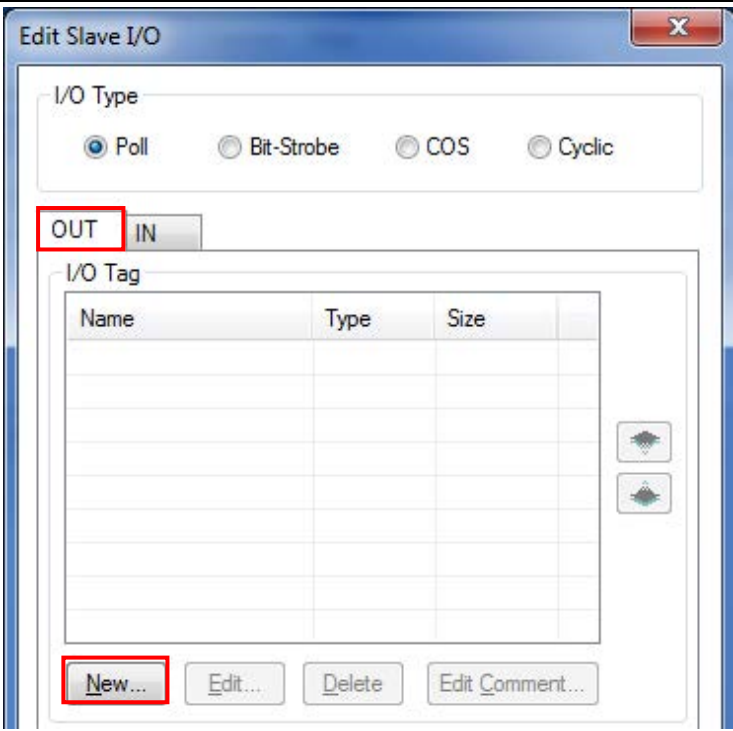

- 8 On the Edit I/O Tag Dialog Box, select the *WORD* Option and enter Area2 in the Name Field.  
Click the **OK** Button.

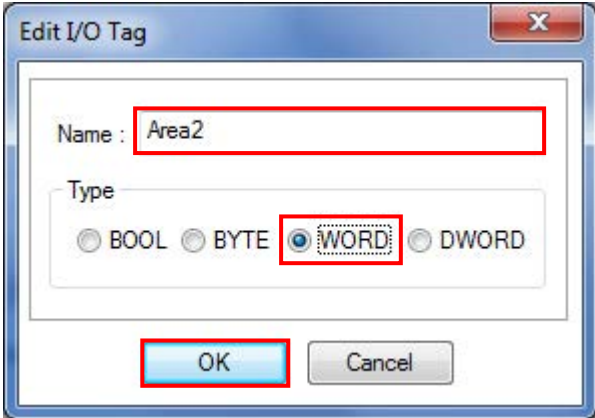



- 9 Area2 is displayed in the OUT Tab Page.  
Click the **OK** Button.

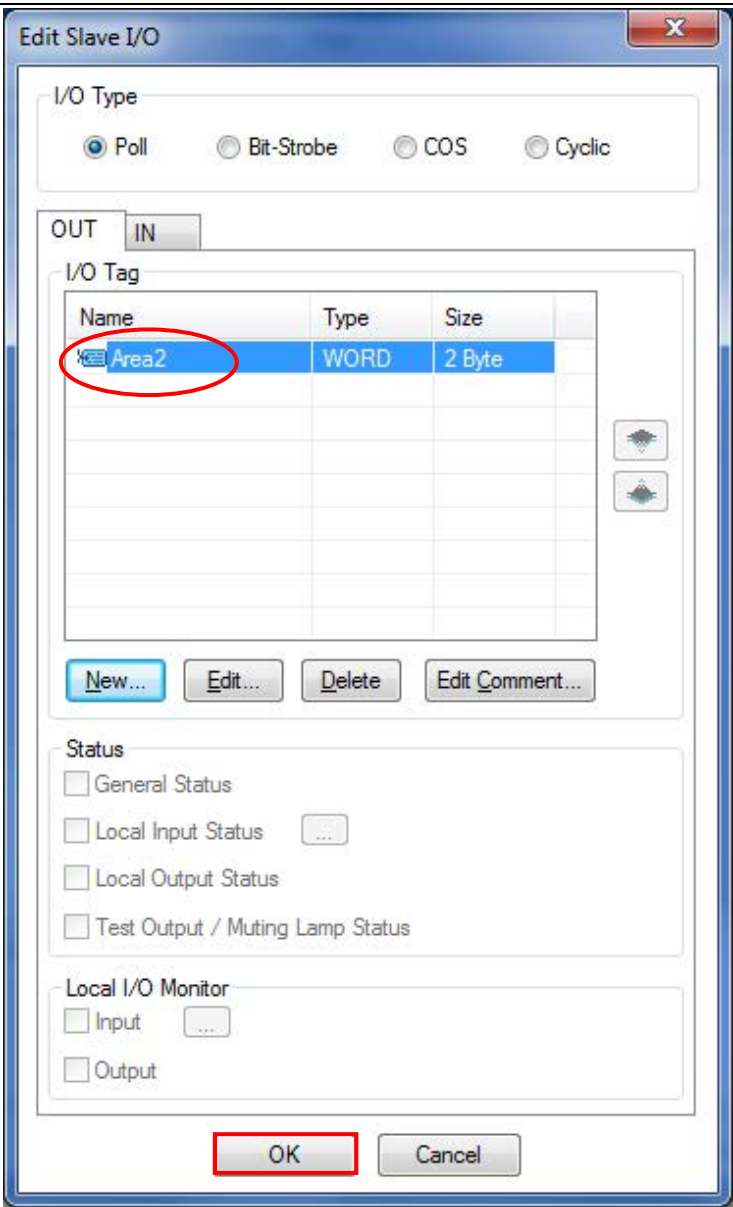

10 The Edit Device Parameters Dialog Box is displayed. Items set in steps 3 to 9 are displayed. Click the **OK** Button.

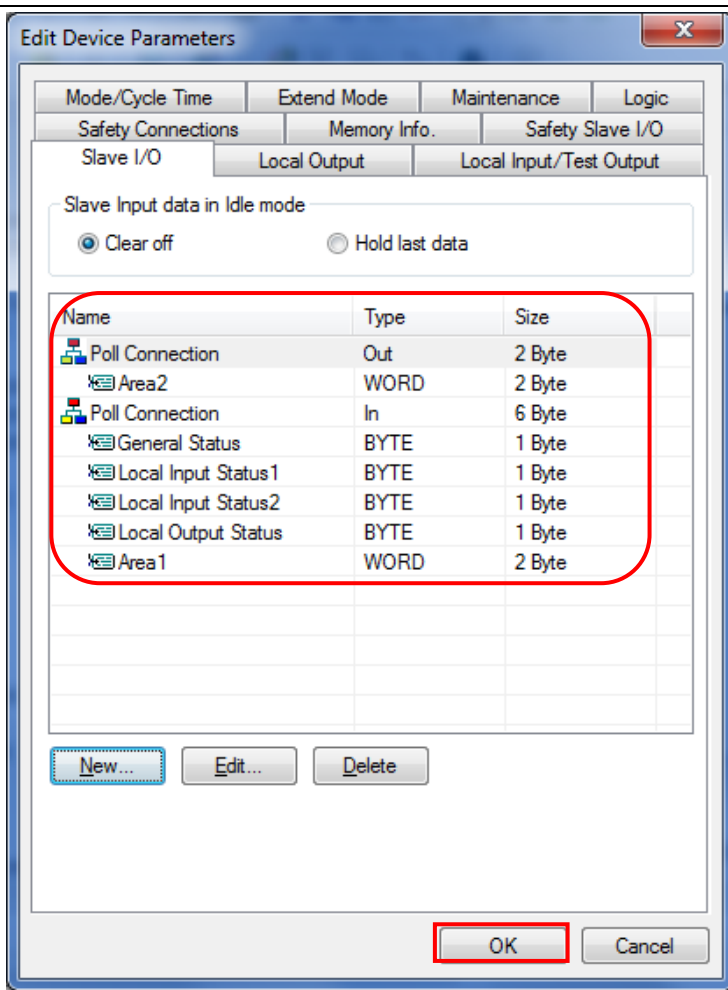

11 Double-click CJ1W-DRM21.

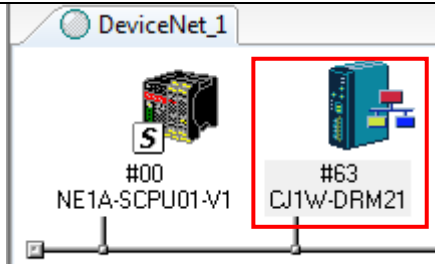

12 The Edit Device Parameters Dialog Box is displayed.

Select the General Tab and select the *Auto allocation as is registered* Check Box.

Select #00 NE1A-SCPU01-V1 Safety Network Controller in the Unregister Device List, and click the  Button.

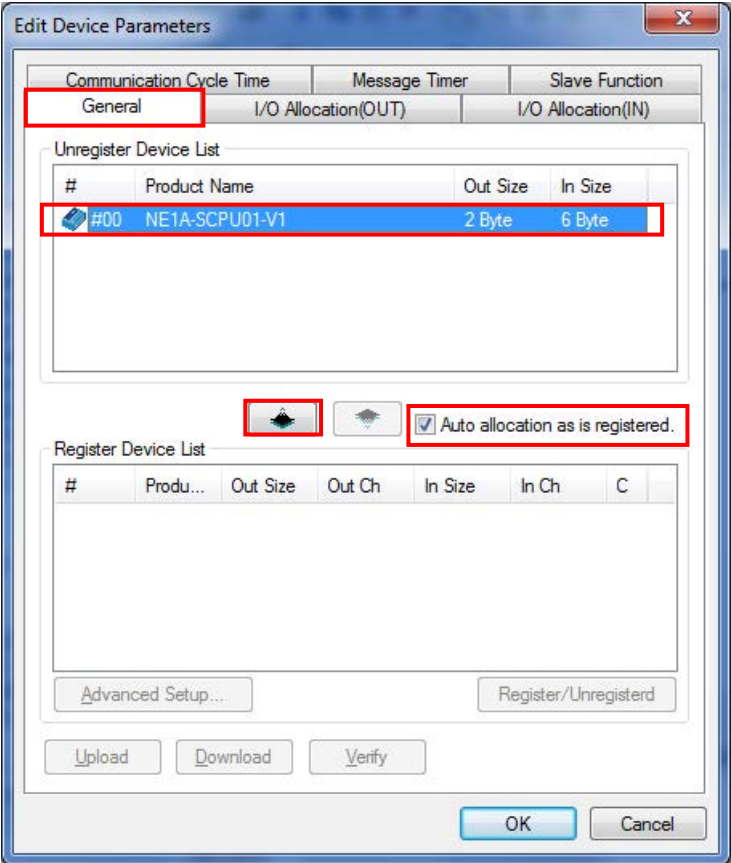

13 The Safety Network Controller is registered in the Register Device List.

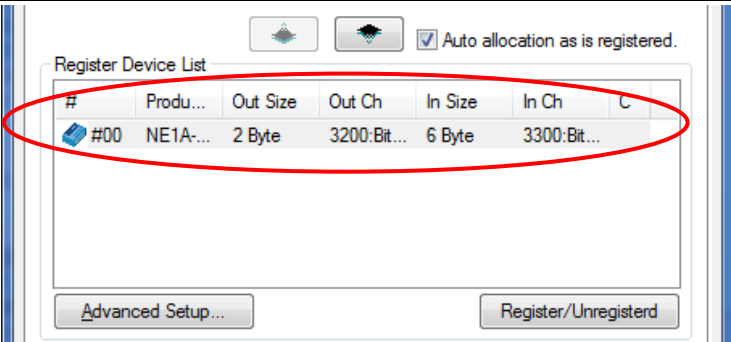

- 14 Select the I/O Allocation (IN) Tab. Confirm that the Safety Network Controller is allocated to Memory Block 1.

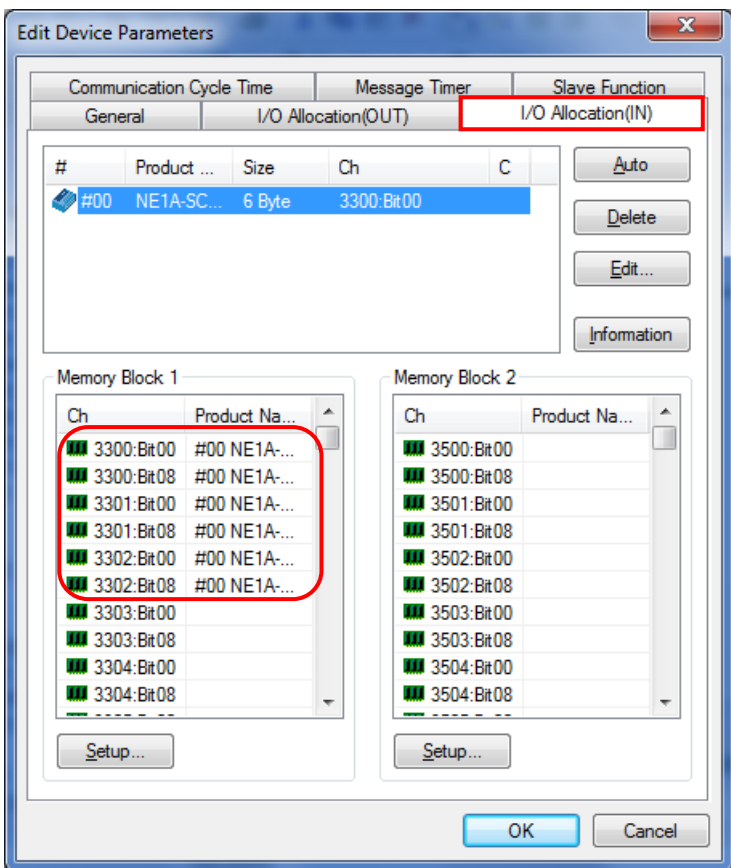

- 15 Select the I/O Allocation (OUT) Tab. Confirm that the Safety Network Controller is allocated to Memory Block 1, and click the OK Button.

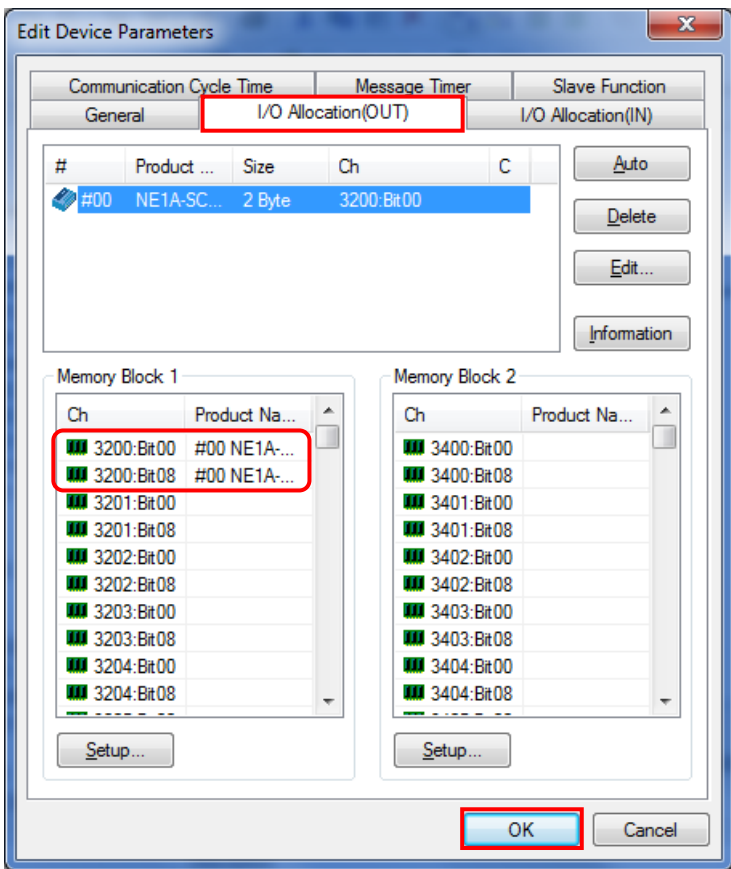

7.4.4. Transferring Device Information

Transfer the device information to the DeviceNet Unit and Safety Network Controller. When transferring the settings is completed, remote I/O communications start automatically.



Application precautions

Please confirm that the DeviceNet cable is connected before proceeding to the following procedure.

If it is not connected, turn OFF the communications power supply and power supply to the devices, and then connect the DeviceNet cable.

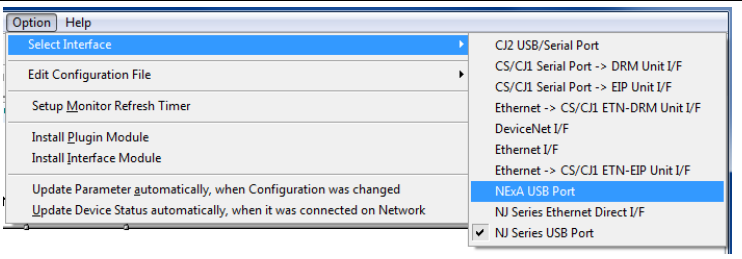
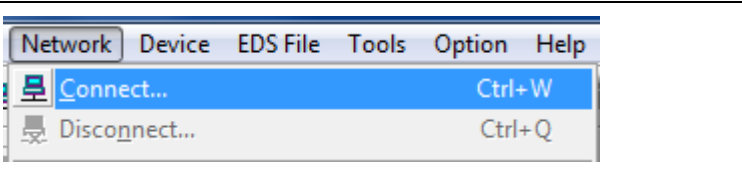
<p>1</p>	<p>Select <b>Select Interface - NExA USB Port</b> from the Option Menu.</p>	
<p>2</p>	<p>Select <b>Connect</b> from the Network Menu.</p>	

3 The Select Connect Network Port Dialog Box is displayed. Select **DeviceNet:2** and click the **OK** Button.

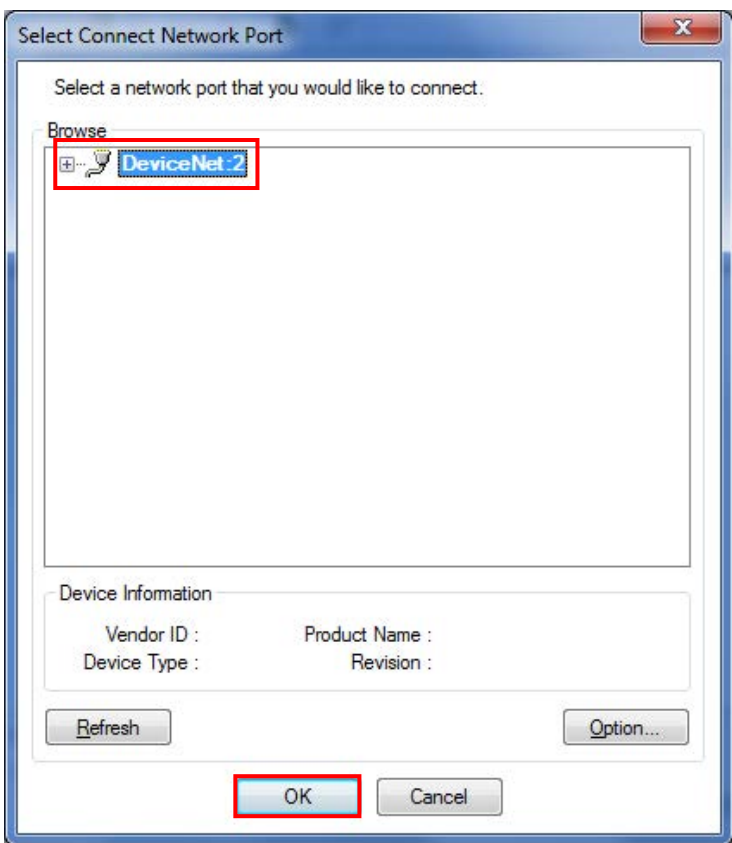

Select the *Use the existing network* Option, and select DeviceNet\_1. Click the **OK** Button.

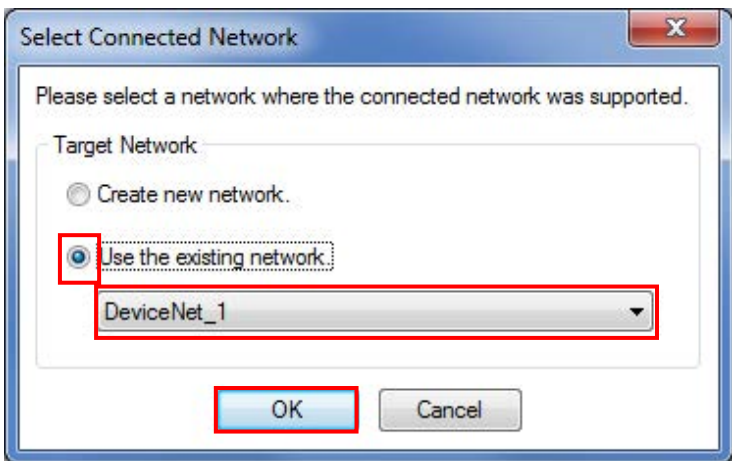

4 On-line is displayed on the Status Bar.

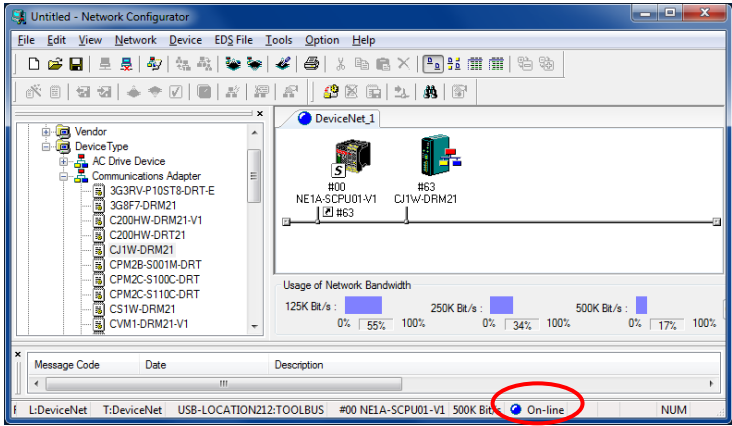

5 Select **Download** from the Network Menu.

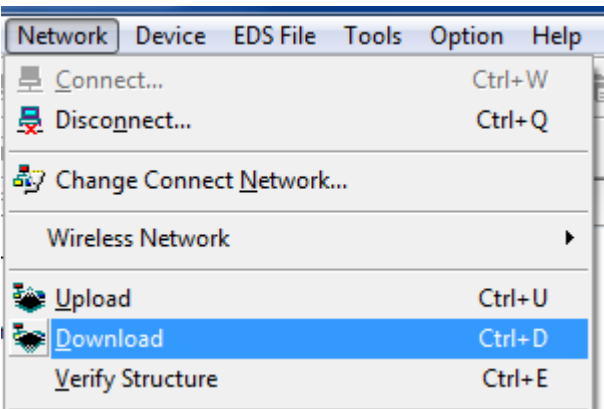

6 A confirmation dialog box is displayed. Click the **Yes** Button.

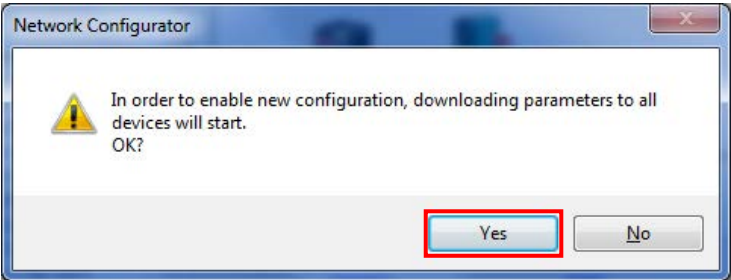

7 Download starts.

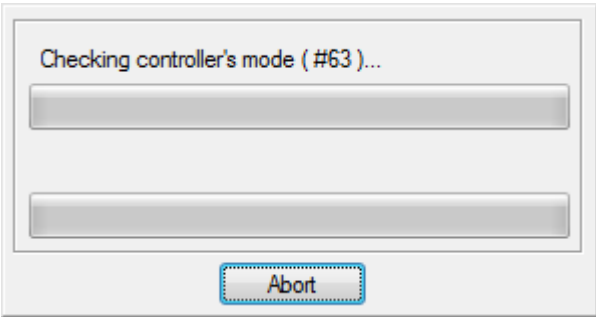



8 If the Controller is not in PROGRAM mode, the figure on the right is displayed. Click the **Continue** Button.

\* If the Controller is in PROGRAM mode, the figure on the right is not displayed.

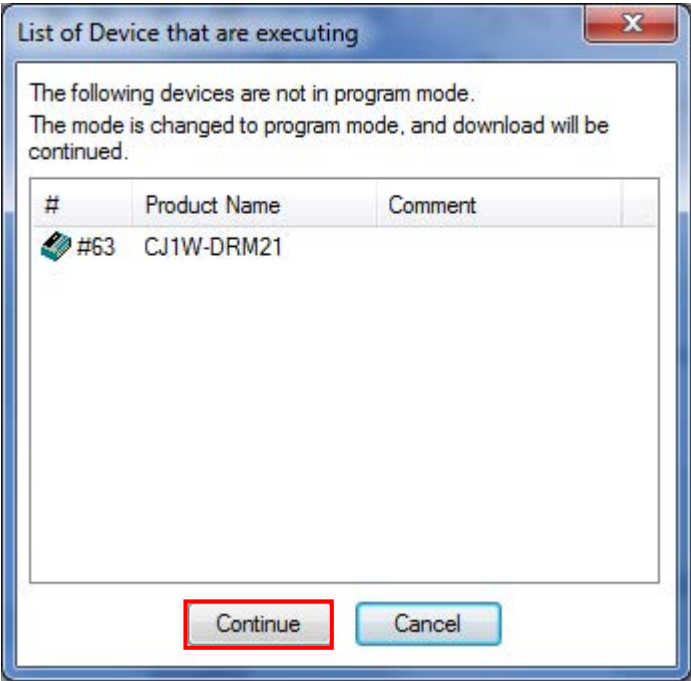
\* If the figure on the right is displayed, a dialog box is displayed in step 11.

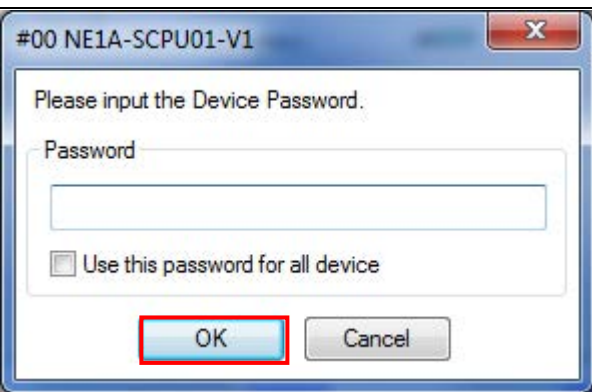
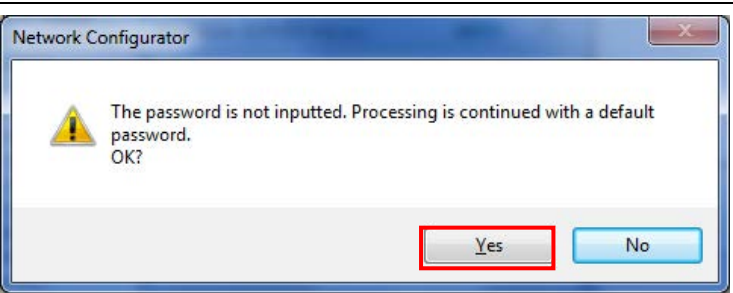
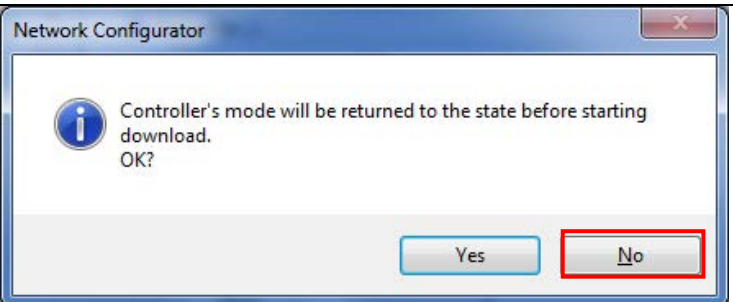
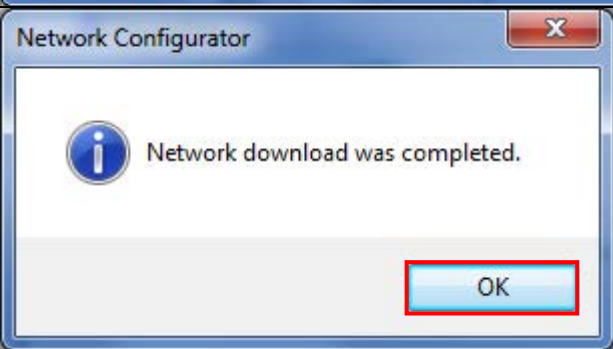

<p>9 A password entry dialog box is displayed. If you do not need a password, click the <b>OK</b> Button.</p> <p>* For details on a password, refer to <i>3-7 Device Password Protection</i> in the <i>CIP Safety™ on DeviceNet System Configuration Manual</i> (Cat. No. Z905).</p>	
<p>10 A confirmation dialog box is displayed. Click the <b>Yes</b> Button.</p> <p>*If a message is displayed stating the TUNID is invalid, refer to <i>Section 8.2</i> and perform the initialization operation.</p>	
<p>11 If a dialog box is displayed in step 8, the confirmation dialog box shown on the right is displayed.</p> <p>Click the <b>No</b> Button to remain in PROGRAM mode.</p>	
<p>12 On a confirmation dialog box, click the <b>OK</b> Button.</p>	
<p>13 After transfer, the Safety Network Controller is in the idle mode, so the MS LED indicator flashes green.</p>	

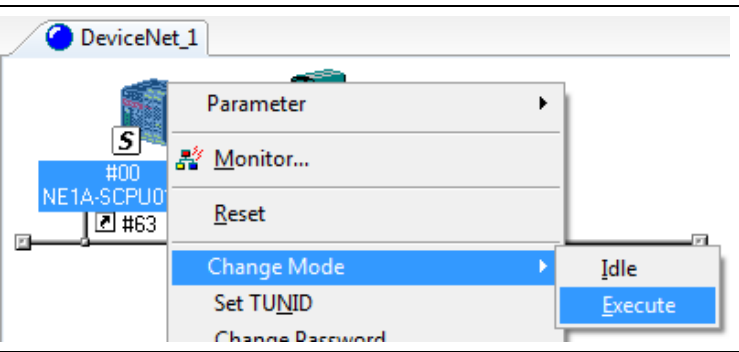
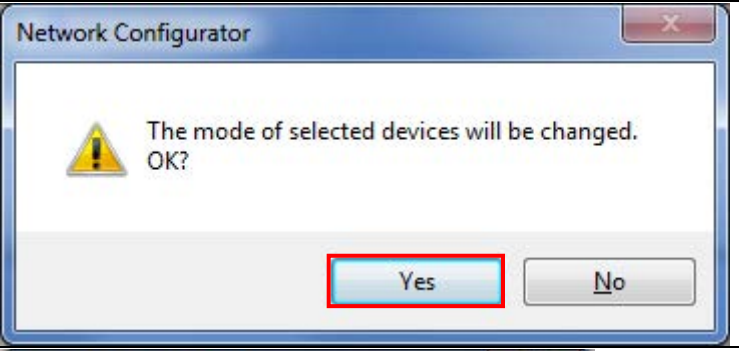
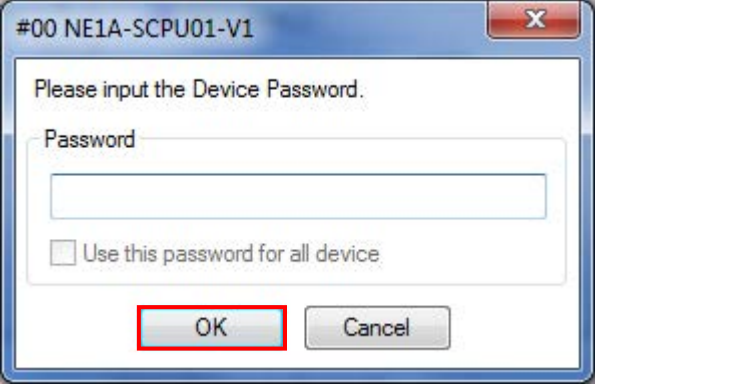
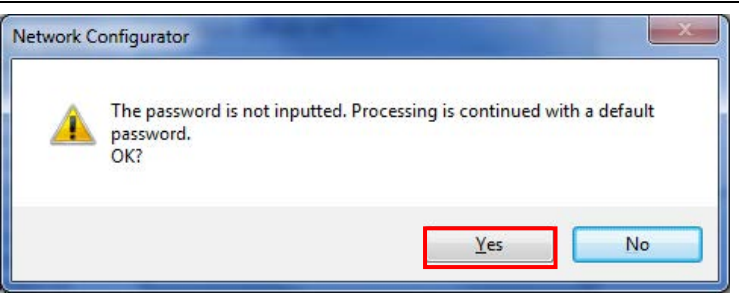

<p>14 Right-click on the Safety Network Controller and select <b>Change Mode - Execute</b>.</p>	
<p>15 Click the <b>Yes</b> Button.</p>	
<p>16 A password entry dialog box is displayed. If you do not need a password, click the <b>OK</b> Button.</p>	
<p>17 Click the <b>Yes</b> Button. The Controller is placed in RUN mode.  *When the Controller is in RUN mode, the MS LED indicator is lit green.</p>	

7.5. Connection Status Check

Check the status of the DeviceNet network connection.

7.5.1. Checking the Connection Status

Confirm that the DeviceNet communication is working.

- 1 Confirm that the DeviceNet communications are performed normally by checking the LED indicators on each unit.

- DeviceNet Unit
  - LED indicators in normal status:
    - MS: Lit green
    - NS: Lit green
  - The 7-segment display is lit and shows 63 during normal operation. (63: Master node address, remote I/O communications active and normal)

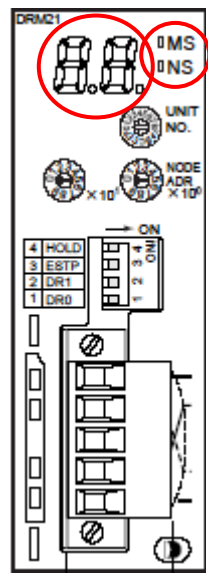

(DeviceNet Unit)

- Safety Network Controller
  - LED indicators in normal status:
    - MS: Lit green
    - NS: Lit green



(Safety Network Controller)

2 Confirm that the DeviceNet communications are performed normally from the Network Configurator by referring to the status information on the Monitor Device Dialog Box.

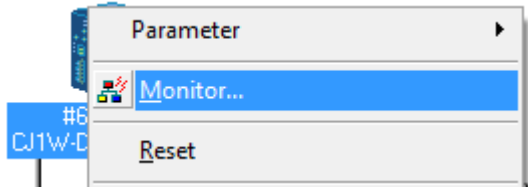

Right-click the master icon on the Network Configuration Pane, and select **Monitor**.

3 The figure on the right shows the Status Tab Page of the Monitor Device Dialog Box.

DeviceNet communications are normally performed if the same items on the right are selected in the Master Status Field, slave #00 is lit blue, and the Remote I/O Communications Running Check Box is selected.

Click the **Close** Button.

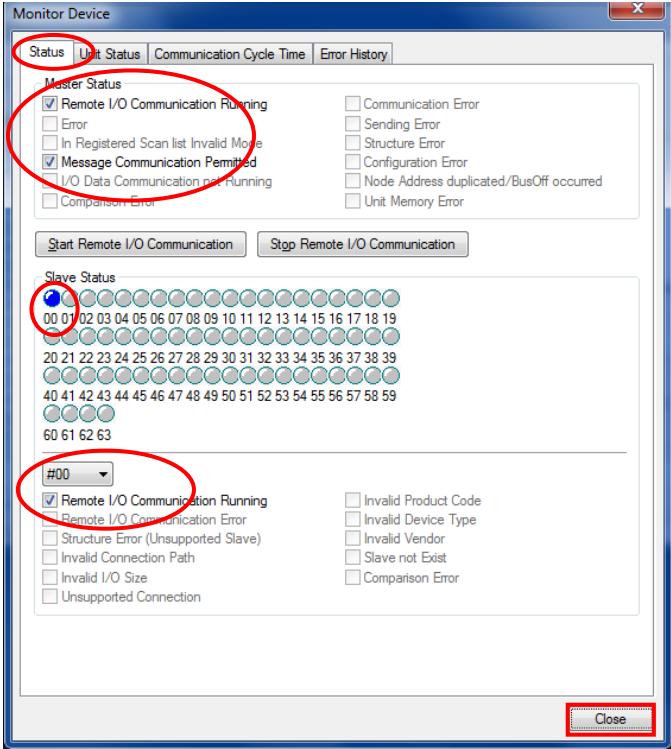

(Monitor Device Dialog Box)

7.5.2. Checking Data That Are Sent and Received

Confirm that the correct data are sent and received.



## WARNING

Always confirm safety at the destination node before you transfer a user program, configuration data, setup data, device variables, or values in memory used for CJ-series Units from the Sysmac Studio.

The devices or machines may perform unexpected operation regardless of the operating mode of the CPU Unit.



- 1

Confirm that the online value of *DN00\_Status\_IN[6]* is True (RUN mode).

Name	Online value	Modify	Data type
DN00_Status_IN[6]	True	TRUE FALSE	BOOL
- 2

Confirm that MS LED indicator of the Safety Network Controller is lit green.

- 3

Right-click the Safety Network Controller and select **Change Mode - Idle**.

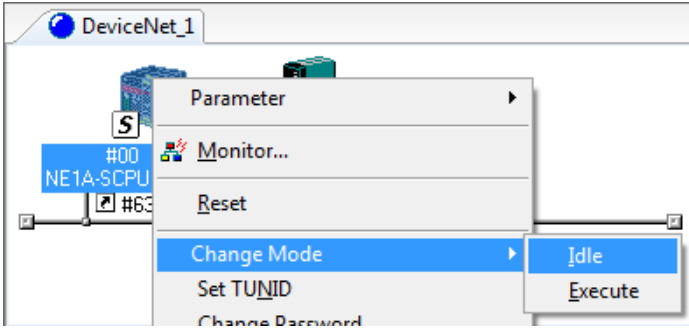

4 A confirmation dialog box is displayed. Click the **Yes** Button.

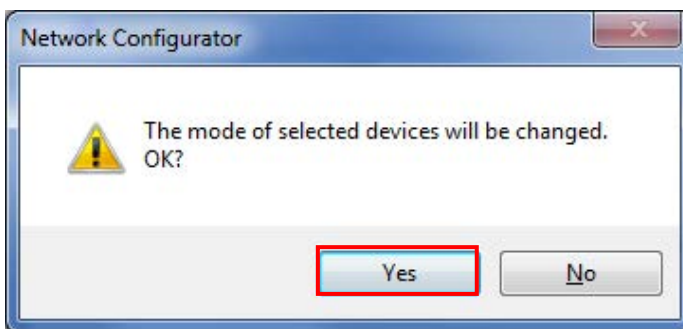

A password entry screen is displayed. Click the **OK** Button, and then click the **Yes** Button.

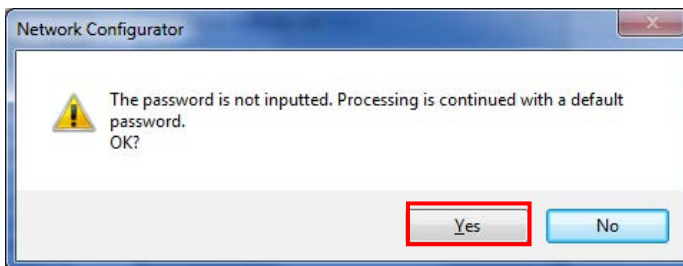
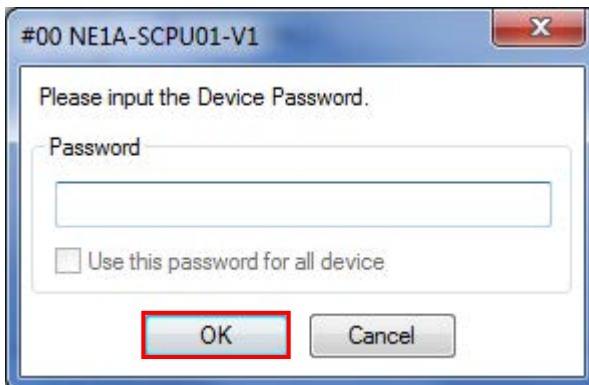

5 Confirm that the Online value of *DN00\_Status\_IN[6]* is False (Idle mode).

Name	Online value	Modify	Data type
DN00_Status_IN[6]	False	TRUE FALSE	BOOL

In the idle mode, the MS LED indicator of the Safety Network Controller flashes green.

## 8. Initialization Method

This document explains the setting procedure from the factory default setting.

Some settings may not be applicable as described in this document unless you use the devices with the factory default setting.

### 8.1. Initializing the Controller

#### 8.1.1. DeviceNet Unit

To initialize the settings of the DeviceNet Unit, select **Edit Special Unit Settings** of CJ1W-DRM21 in CPU/Expansion Racks from the Sysmac Studio.

Select ***Clears the scan list*** from the Scan List Clear Switch.

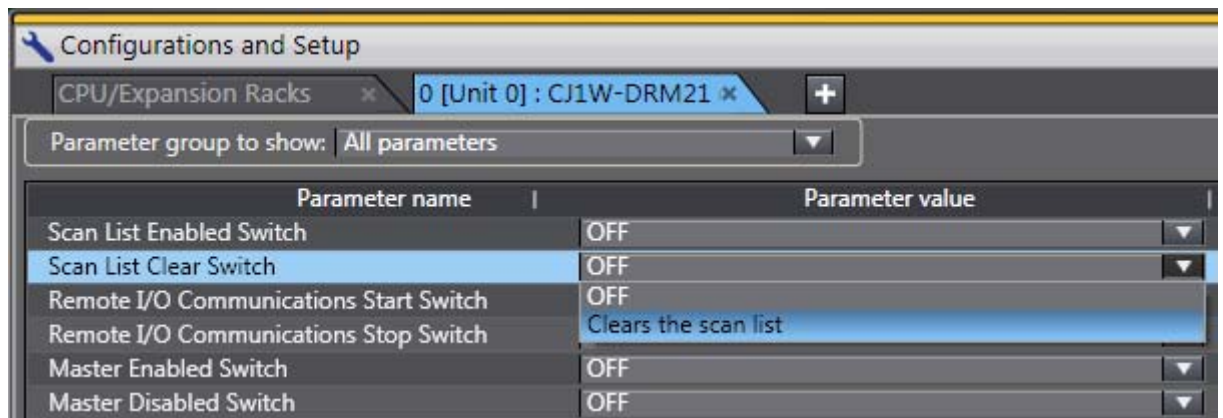

Click the **Apply** Button and click the **Transfer to Controller** Button.

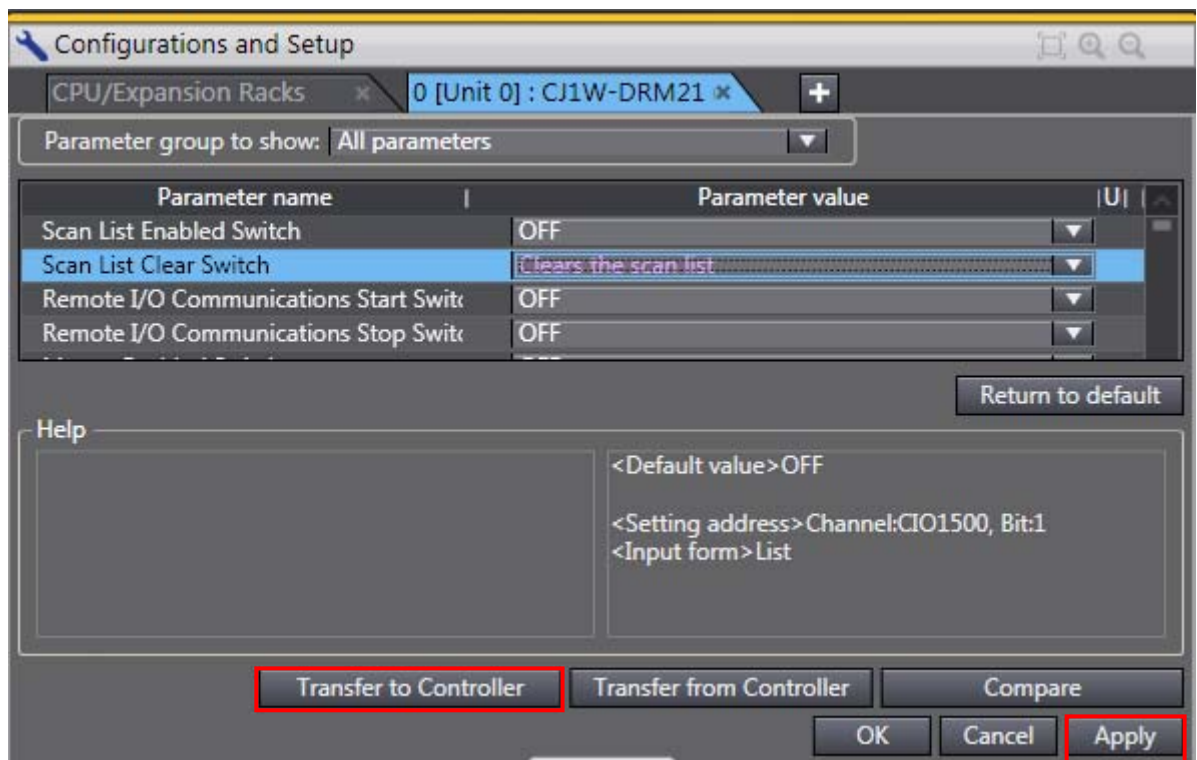

### 8.1.2. Controller

To initialize the settings of the Controller, select **Clear All Memory** from the Controller Menu of the Sysmac Studio.

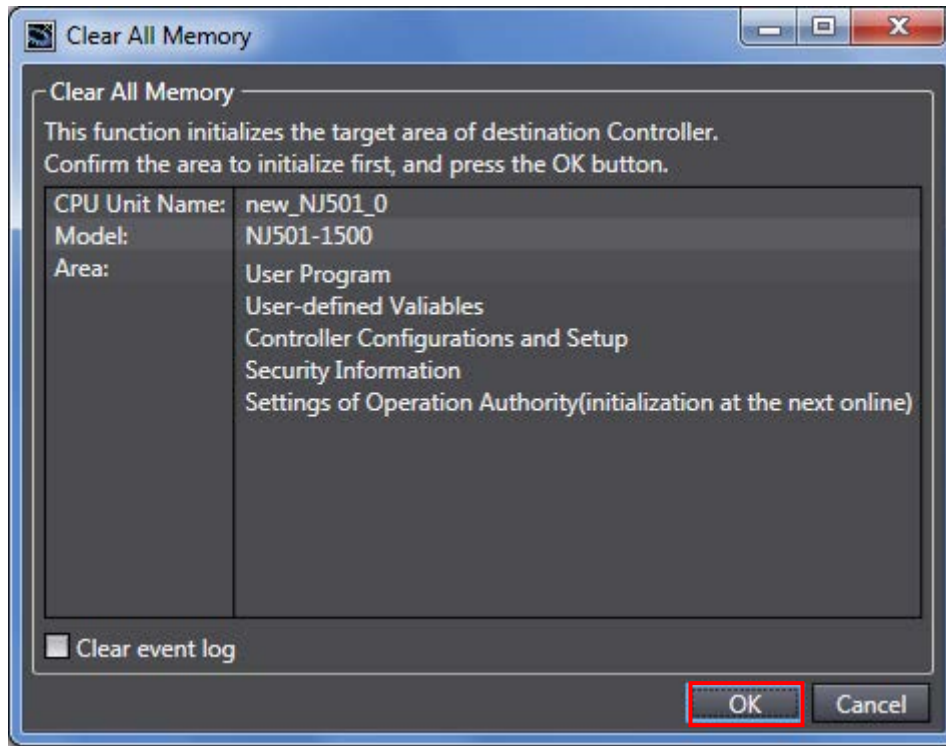

## 8.2. Initializing the Safety Network Controller

For information on how to initialize the Safety Network Controller, refer to 9.12 *Resetting a Device* in the *DeviceNet Safety System Configuration Manual* (Cat. No. Z905).

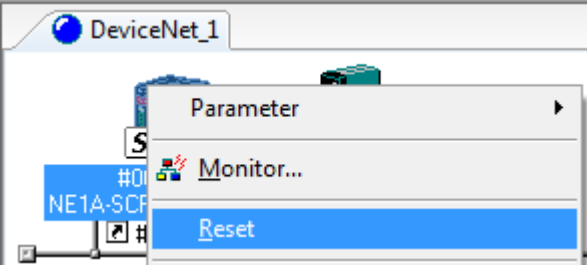
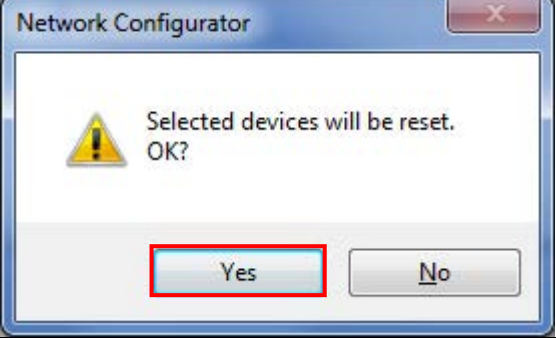
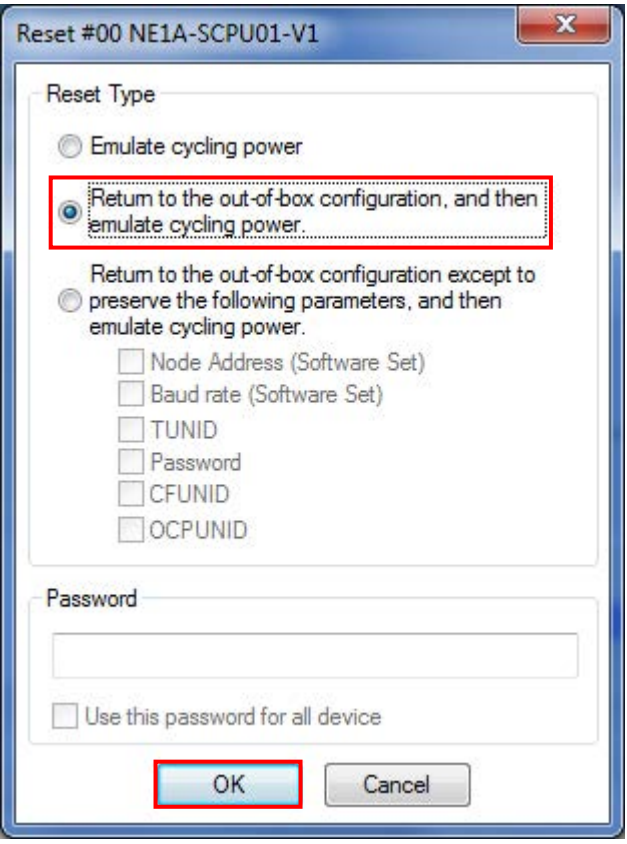
1	Right-click on the Safety Network Controller and select <b>Reset</b> .	 <p>The screenshot shows the 'DeviceNet_1' window with a context menu open over a device icon. The menu items are 'Parameter', 'Monitor...', and 'Reset'. The 'Reset' option is highlighted in blue.</p>
2	Click the <b>Yes</b> Button in the dialog box on the right.	 <p>The screenshot shows a 'Network Configurator' dialog box with a warning icon and the text 'Selected devices will be reset. OK?'. There are 'Yes' and 'No' buttons at the bottom. The 'Yes' button is highlighted with a red rectangle.</p>
3	Select the <i>Return to the out-of-box configuration, and then emulate cycling power</i> Option. Then, click the <b>OK</b> Button.	 <p>The screenshot shows a 'Reset #00 NE1A-SCPU01-V1' dialog box. Under 'Reset Type', the option 'Return to the out-of-box configuration, and then emulate cycling power.' is selected and highlighted with a red rectangle. Below it are several unchecked checkboxes: 'Node Address (Software Set)', 'Baud rate (Software Set)', 'TUNID', 'Password', 'CFUNID', and 'OCPUNID'. There is a 'Password' text field and an unchecked checkbox 'Use this password for all device'. At the bottom, the 'OK' button is highlighted with a red rectangle.</p>



- 4 A password confirmation dialog box and a TUNID confirmation dialog box are displayed. Click the **Yes** Button.

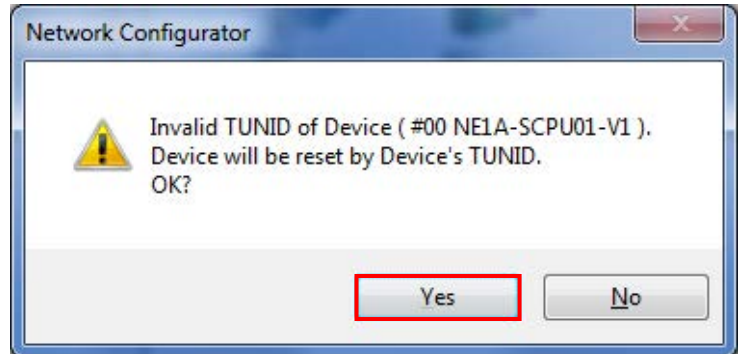
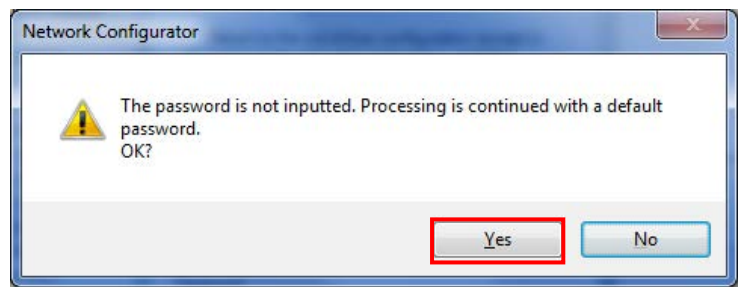

- 5 The MS LED indicator is lit red and green alternately. Then the Safety Network Controller returns to the factory settings.

## 9. Appendix Connection Using the “Project File”

This section describes the “project file” which contains the settings made in the following sections: 7.3.2. Starting the Sysmac Studio and Setting the Parameters for the Controller, 7.3.3. Setting Global Variables and 7.3.6. Settings in the Watch Tab Page.

The setting procedure can be simplified by using the “project file”.

### 9.1. Project File

Obtain the latest “Sysmac Studio project file” from OMRON beforehand.

Name	File name	Version
Sysmac Studio project file (extension: SMC)	OMRON_NE1A_DN_EV100.SMC	Ver.1.00

### 9.2. Overview of Setting Up Remote I/O Communications Using “Project File”

The following figure shows the relationship of processes to perform DeviceNet remote I/O communications using the “Sysmac Studio project file”.

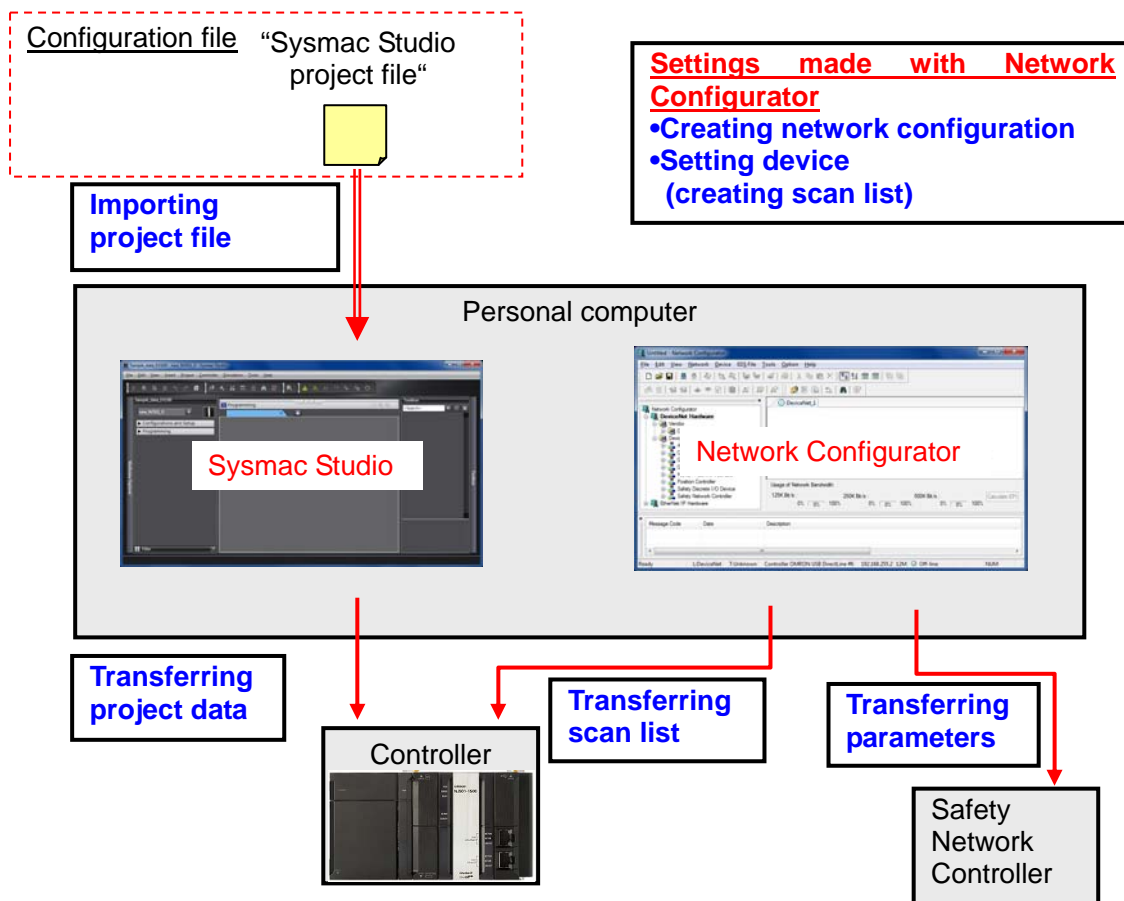

**9.3. Work Flow**

Take the following steps to make the connection settings for remote I/O communications of DeviceNet.

Instead of 7.3.2. Starting the Sysmac Studio and Setting the Parameters for the Controller, 7.3.3. Setting Global Variables and 7.3.6. Settings in the Watch Tab Page, perform the procedure described in 9.3.1 Starting the Sysmac Studio and Importing the Project File shown in the red frame.

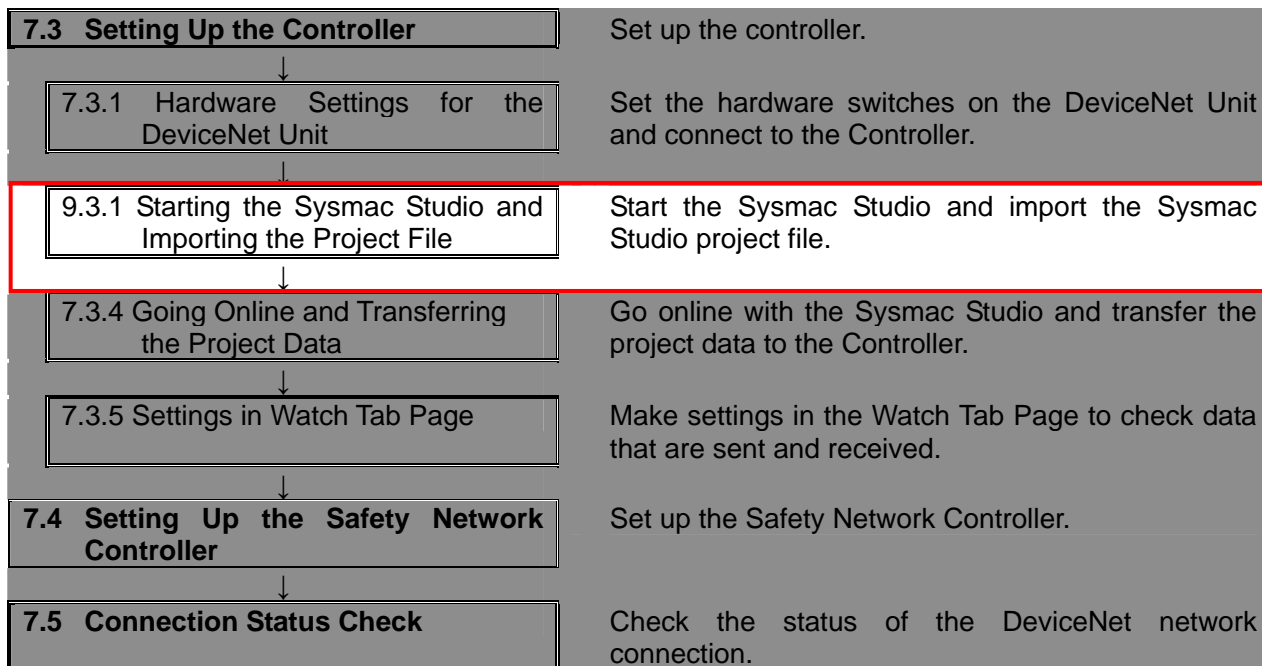

9.3.1. Starting the Sysmac Studio and Importing the Project File

Start the Sysmac Studio and import the Sysmac Studio project file.

Install the Sysmac Studio and USB driver in the personal computer beforehand.

- 1 Start the Sysmac Studio. Click the **Import** Button.

\*If a confirmation dialog for an access right is displayed at start, select to start.

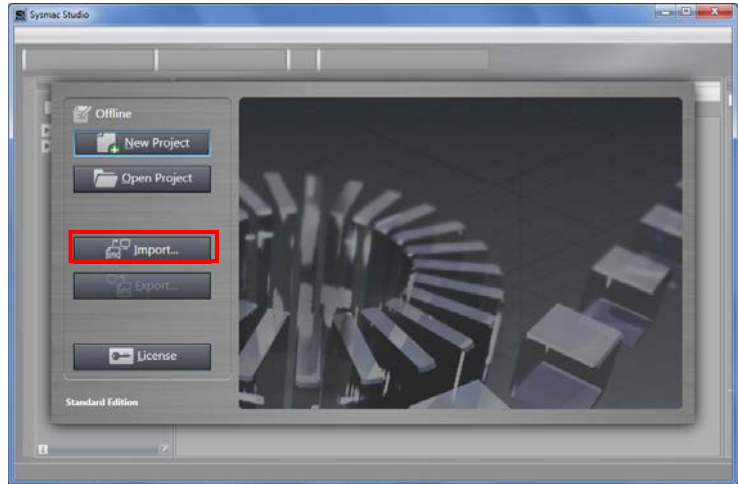

- 2 The Import File Dialog Box is displayed. Select OMRON\_NE1A\_DN\_EV100.SM C (Sysmac Studio project file) and click the **Open** Button.

\*Obtain the Sysmac Studio project file from OMRON.

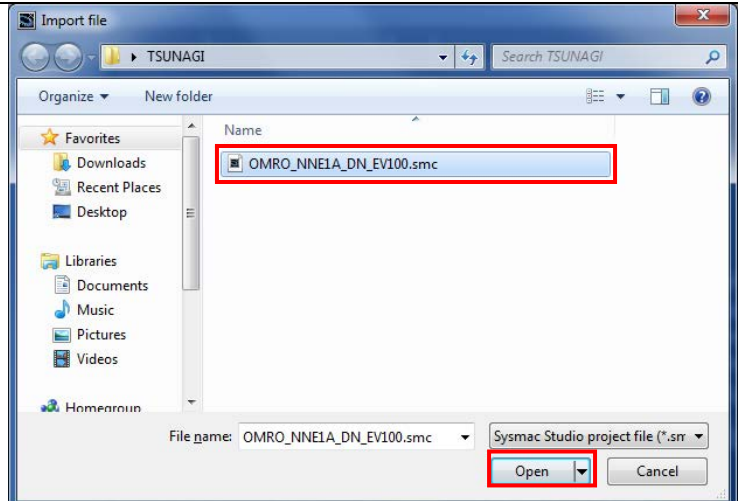

- 3 The OMRON\_NE1A\_DN\_EV100 project is displayed. The left pane is called Multiview Explorer, the right pane is called Toolbox and the middle pane is called Edit Pane.

\*If an error message is displayed stating “Failed to Load Descendants”, change the version of the Sysmac Studio to any version specified in 5.2. Device Configuration.

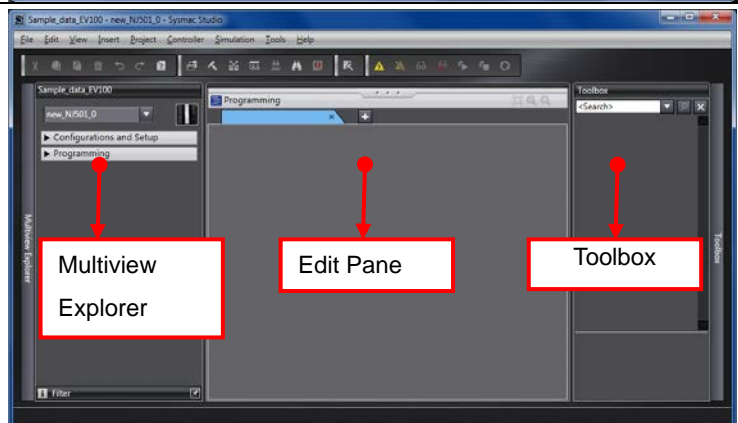

## 10. Revision History

Revision code	Date of revision	Revision reason and revision page
A	Aug. 1, 2013	First edition

**OMRON Corporation Industrial Automation Company**

Tokyo, JAPAN

Contact: [www.ia.omron.com](http://www.ia.omron.com)

**Regional Headquarters**

**OMRON EUROPE B.V.**

Wegalaan 67-69-2132 JD Hoofddorp  
The Netherlands

Tel: (31)2356-81-300/Fax: (31)2356-81-388

**OMRON ELECTRONICS LLC**

One Commerce Drive Schaumburg,  
IL 60173-5302 U.S.A.

Tel: (1) 847-843-7900/Fax: (1) 847-843-7787

**OMRON ASIA PACIFIC PTE. LTD.**

No. 438A Alexandra Road # 05-05/08 (Lobby 2),  
Alexandra Technopark,  
Singapore 119967

Tel: (65) 6835-3011/Fax: (65) 6835-2711

**OMRON (CHINA) CO., LTD.**

Room 2211, Bank of China Tower,  
200 Yin Cheng Zhong Road,  
PuDong New Area, Shanghai, 200120, China

Tel: (86) 21-5037-2222/Fax: (86) 21-5037-2200

Authorized Distributor:

© OMRON Corporation 2013 All Rights Reserved.  
In the interest of product improvement,  
specifications are subject to change without notice.

Cat. No. **P551-E1-01**

1308\*\*(-)