

Automation Software Sysmac Studio

Practices Guide

Electrical CAD Connector Function AutomationML Import (EPLAN Electric P8)

SYSMAC-SE2□□□

Practices
Guide

NOTE

1. All rights reserved. No part of this publication may be reproduced, stored in a retrieval system, or transmitted, in any form, or by any means, mechanical, electronic, photocopying, recording, or otherwise, without the prior written permission of OMRON.
2. No patent liability is assumed with respect to the use of the information contained herein. Moreover, because OMRON is constantly striving to improve its high-quality products, the information contained in this manual is subject to change without notice.
3. Every precaution has been taken in the preparation of this manual. Nevertheless, OMRON assumes no responsibility for errors or omissions. Neither is any liability assumed for damages resulting from the use of the information contained in this publication.

Trademarks

- Sysmac and SYSMAC are trademarks or registered trademarks of OMRON Corporation in Japan and other countries for OMRON factory automation products.
- Microsoft, Windows, Excel, Visual Basic, and Microsoft Edge are either registered trademarks or trademarks of Microsoft Corporation in the United States and other countries.
- EtherCAT® is registered trademark and patented technology, licensed by Beckhoff Automation GmbH, Germany.
- ODVA, CIP, CompoNet, DeviceNet, and EtherNet/IP are trademarks of ODVA.
- The SD and SDHC logos are trademarks of SD-3C, LLC. 
- NVIDIA, the NVIDIA logo, GeForce, and the GeForce logo are the trademarks or registered trademarks of NVIDIA Corporation in the USA and other countries.
- ATI™ and Radeon™ are the trademarks of Advanced Micro Devices, Inc.
- Celeron, Intel and Intel Core are trademarks of Intel Corporation in the U.S. and / or other countries.
- Git and the Git logo are either registered trademarks or trademarks of Software Freedom Conservancy, Inc., corporate home of the Git Project, in the United States and/or other countries.
- JavaScript® is a trademark or registered trademark of Oracle Corporation and its subsidiaries and affiliates in the United States and other countries.
- EPLAN and EPLAN Electric P8 are registered trademarks of EPLAN GmbH & Co.KG.

Other company names and product names in this document are the trademarks or registered trademarks of their respective companies.

Copyrights

Microsoft product screen shots used with permission from Microsoft.

Introduction

Thank you for purchasing the Sysmac Studio Automation Software.

This manual contains information that is necessary to use the Sysmac Studio/EPLAN Electric P8 connector function. Please read the *Sysmac Studio Version 1 Operation Manual (Cat. No. W504)* and this manual carefully to fully understand the functions and the performance before using the Sysmac Studio for building your systems.

Intended Audience

This manual is intended for the following personnel who have knowledge of electrical systems (an electrical engineer or the equivalent).

- Personnel with experience in designing electrical systems using EPLAN Electric P8.
- Personnel with experience in designing control systems using Sysmac Studio.
- Personnel in charge of introducing FA systems.
- Personnel in charge of designing FA systems.
- Personnel in charge of installing and setting up FA systems.
- Personnel in charge of managing FA systems and facilities.

It is also intended for personnel who understand the programming language specifications in international standards IEC 61131-3 or Japanese standards JIS B 3503, and the AutomationML specifications in international standards IEC 62714.

Manual Structure

Page Structure

The following page structure is used in this manual.

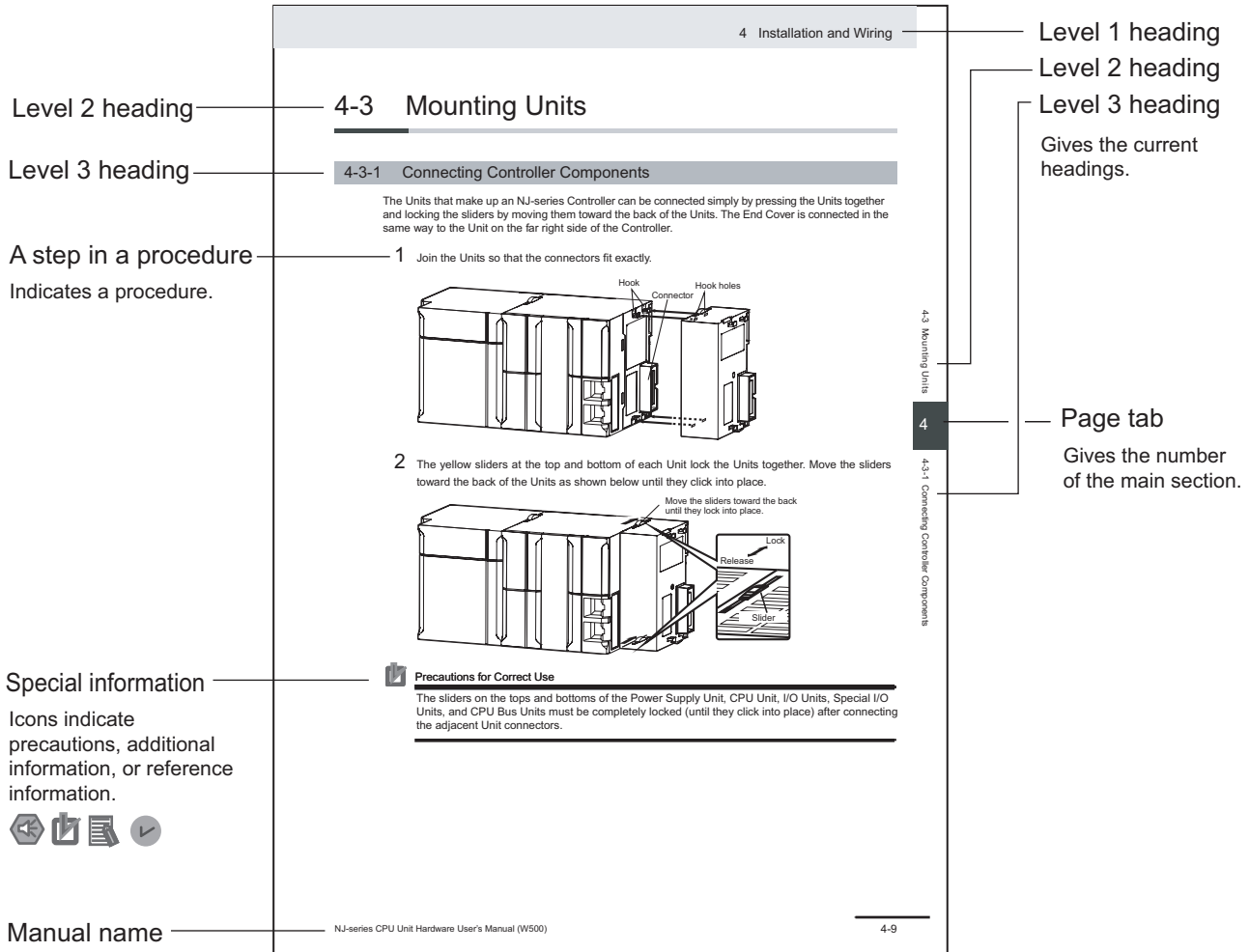

This illustration is provided only as a sample. It may not literally appear in this manual.

Special Information

Special information in this manual is classified as follows:



Precautions for Safe Use

Precautions on what to do and what not to do to ensure safe usage of the product.



Precautions for Correct Use

Precautions on what to do and what not to do to ensure proper operation and performance.



Additional Information

Additional information to read as required.

This information is provided to increase understanding or make operation easier.



Version Information

Information on differences in specifications and functionality for Controllers and Units with different unit versions and for different versions of Support Software is given.

Precaution on Terminology

- For descriptions of the CPU Unit and Controller terms that are used in this manual, refer to information on terminology in the *NJ/NX-series CPU Unit Software User's Manual (Cat. No. W501)*.
- In this manual, the functions of a specific model of the NX-series CPU Units/Controllers may be described with its model specified, such as “NX701 CPU Unit/Controller” or “NX1P2 CPU Unit/Controller.”
- The Sysmac Studio supports the NJ/NX/NY-series Controllers. Unless another Controller series is specified, the operating procedures and screen captures used in the manual are examples for the NJ-series Controllers.

Sections in this Manual

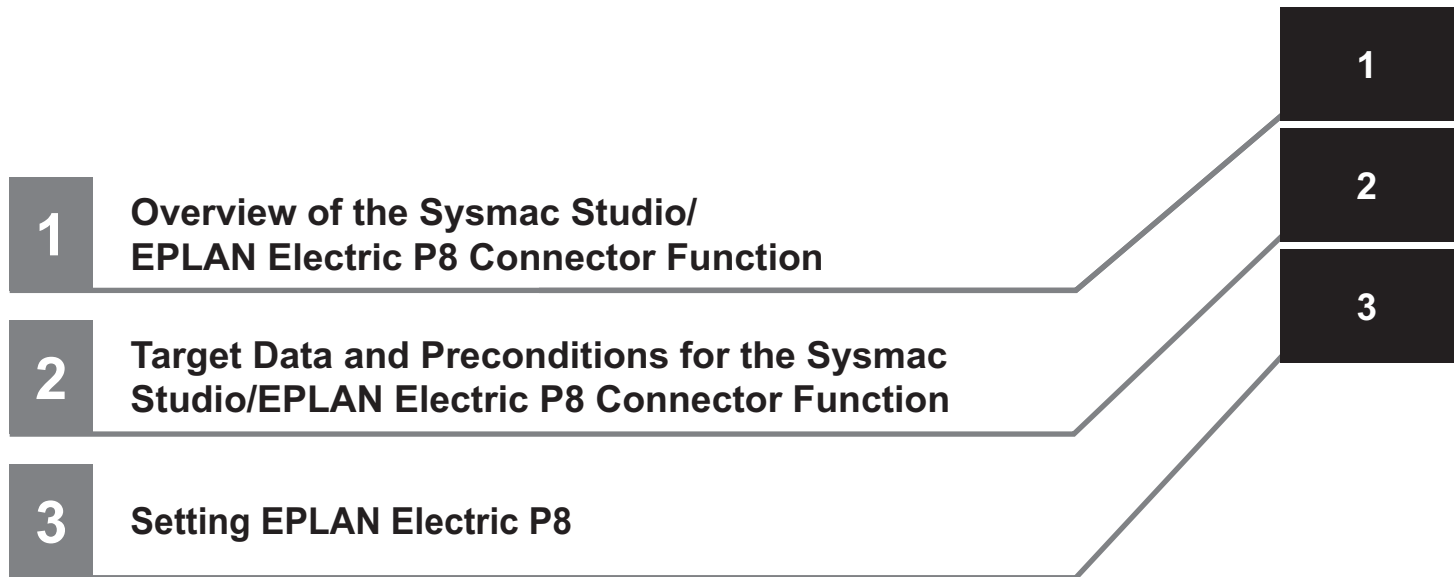

CONTENTS

Introduction	1
Intended Audience	1
Manual Structure.....	2
Page Structure.....	2
Special Information	2
Precaution on Terminology	3
Sections in this Manual	5
Terms and Conditions Agreement.....	8
Terms and Conditions Agreement on EPLAN Electric P8.....	10
Safety Precautions.....	11
Precautions for Safe Use	12
Precautions for Correct Use	13
Regulations and Standards	14
Related Manuals.....	15
Terminology.....	16
Revision History.....	17

Section 1 Overview of the Sysmac Studio/EPLAN Electric P8 Connector Function

1-1 Features of the Sysmac Studio/EPLAN Electric P8 Connector Function.....	1-2
1-2 System Configuration.....	1-3
1-3 Required Software	1-4

Section 2 Target Data and Preconditions for the Sysmac Studio/EPLAN Electric P8 Connector Function

2-1 Target Data for the Sysmac Studio/EPLAN Electric P8 Connector Function.....	2-2
2-1-1 CPU Units	2-2
2-1-2 EtherCAT Slaves	2-3
2-1-3 NX Units	2-6
2-1-4 CJ-series Units.....	2-9
2-1-5 Device Variables.....	2-10
2-2 Preconditions for the Sysmac Studio/EPLAN Electric P8 Connector Function	2-11
2-2-1 Preconditions for Using the Connector Function.....	2-11
2-2-2 Preconditions for Importing Target Data.....	2-11

2-3	Flow of Development with the Sysmac Studio/EPLAN Electric P8 Connector	
	Function	2-13
2-3-1	Generating a Control Project from Electrical Drawing Data	2-13
2-3-2	Correcting Device Variable Assignments	2-14
2-3-3	Correcting Device Variable Comments	2-14
2-3-4	Changing the Controller Configuration	2-15

Section 3 Setting EPLAN Electric P8

3-1	Understanding the EPLAN Electric P8 Setting Items	3-2
3-2	Setting Component Data	3-3
3-2-1	CPU Units	3-3
3-2-2	OMRON EtherCAT Slaves	3-3
3-2-3	Other EtherCAT Slaves	3-6
3-2-4	NX Units	3-7
3-2-5	CJ-series Units	3-7
3-2-6	Device Variables	3-8
3-3	Setting the Project	3-9
3-3-1	CPU Units	3-9
3-3-2	EtherCAT Slaves	3-9
3-3-3	NX Units	3-11
3-3-4	CJ-series Units	3-13
3-3-5	Device Variables	3-15
3-3-6	Power Supply Units	3-15
3-4	Setting the AML File Export	3-16

Terms and Conditions Agreement

WARRANTY

- The warranty period for the Software is one year from the date of purchase, unless otherwise specifically agreed.
- If the User discovers defect of the Software (substantial non-conformity with the manual), and return it to OMRON within the above warranty period, OMRON will replace the Software without charge by offering media or download from OMRON's website. And if the User discovers defect of media which is attributable to OMRON and return it to OMRON within the above warranty period, OMRON will replace defective media without charge. If OMRON is unable to replace defective media or correct the Software, the liability of OMRON and the User's remedy shall be limited to the refund of the license fee paid to OMRON for the Software.

LIMITATION OF LIABILITY

- THE ABOVE WARRANTY SHALL CONSTITUTE THE USER'S SOLE AND EXCLUSIVE REMEDIES AGAINST OMRON AND THERE ARE NO OTHER WARRANTIES, EXPRESSED OR IMPLIED, INCLUDING BUT NOT LIMITED TO, WARRANTY OF MERCHANTABILITY OR FITNESS FOR PARTICULAR PURPOSE. IN NO EVENT, OMRON WILL BE LIABLE FOR ANY LOST PROFITS OR OTHER INDIRECT, INCIDENTAL, SPECIAL OR CONSEQUENTIAL DAMAGES ARISING OUT OF USE OF THE SOFTWARE.
- OMRON SHALL HAVE NO LIABILITY FOR DEFECT OF THE SOFTWARE BASED ON MODIFICATION OR ALTERNATION TO THE SOFTWARE BY THE USER OR ANY THIRD PARTY. OMRON SHALL NOT BE RESPONSIBLE AND/OR LIABLE FOR ANY LOSS, DAMAGE, OR EXPENSES DIRECTLY OR INDIRECTLY RESULTING FROM THE INFECTION OF OMRON PRODUCTS, ANY SOFTWARE INSTALLED THEREON OR ANY COMPUTER EQUIPMENT, COMPUTER PROGRAMS, NETWORKS, DATABASES OR OTHER PROPRIETARY MATERIAL CONNECTED THERETO BY DISTRIBUTED DENIAL OF SERVICE ATTACK, COMPUTER VIRUSES, OTHER TECHNOLOGICALLY HARMFUL MATERIAL AND/OR UNAUTHORIZED ACCESS.
- OMRON SHALL HAVE NO LIABILITY FOR SOFTWARE DEVELOPED BY THE USER OR ANY THIRD PARTY BASED ON THE SOFTWARE OR ANY CONSEQUENCE THEREOF.

APPLICABLE CONDITIONS

USER SHALL NOT USE THE SOFTWARE FOR THE PURPOSE THAT IS NOT PROVIDED IN THE ATTACHED USER MANUAL.

CHANGE IN SPECIFICATION

The software specifications and accessories may be changed at any time based on improvements and other reasons.

ERRORS AND OMISSIONS

The information in this manual has been carefully checked and is believed to be accurate; however, no responsibility is assumed for clerical, typographical, or proofreading errors, or omissions.

Terms and Conditions Agreement on EPLAN Electric P8

- **LIMITATION OF LIABILITY**

ALTHOUGH THIS MANUAL CONTAINS REFERENCES TO THE OPERATION PROCEDURES AND SCREEN ITEMS OF EPLAN ELECTRIC P8 DEVELOPED BY EPLAN FOR ILLUSTRATIVE PURPOSES, OMRON SHALL NOT GUARANTEE THE ACCURACY AND OTHER ASPECTS OF ITS CONTENTS. OMRON SHALL NOT BE RESPONSIBLE AND/OR LIABLE FOR ANY TROUBLE, LOSS, DAMAGE, OR EXPENSES DIRECTLY OR INDIRECTLY RESULTING FROM USE OF THE CONTENTS OR INFORMATION IN THIS MANUAL IN CONNECTION WITH THE EPLAN ELECTRIC P8.

Safety Precautions

Refer to the *Sysmac Studio Version 1 Operation Manual (Cat. No. W504)* for safety precautions.

Precautions for Safe Use

Refer to the *Sysmac Studio Version 1 Operation Manual (Cat. No. W504)* for precautions for safe use.

Precautions for Correct Use

Refer to the *Sysmac Studio Version 1 Operation Manual (Cat. No. W504)* for precautions for correct use.

Regulations and Standards

Refer to the *Sysmac Studio Version 1 Operation Manual (Cat. No. W504)* for information on regulations and standards.

Related Manuals

The following manuals are related to this manual. Use these manuals for reference.

Manual name	Cat. No.	Model number	Application	Description
Sysmac Studio Version 1 Operation Manual	W504	SYSMAC -SE2□□□	Learning about the operating proce- dures and functions of the Sysmac Stu- dio.	Describes the operating proce- dures of the Sysmac Studio.

Terminology

Term	Description
AML	An abbreviation of AutomationML. AutomationML is an XML-based data modeling language defined to model engineering data.
AML file	A file described in AML. In this manual, the term refers to a file exported from EPLAN Electric P8.
Controller configurations	A generic term that refers to the Unit configurations of buses and network devices connected to a Controller, such as EtherCAT configuration, EtherCAT Slave Terminal configuration, and CPU and Expansion Rack configuration.
MDP	An abbreviation of Modular Device Profile. MDPs define data structures for EtherCAT slave settings. They are part of the EtherCAT specifications. The Sysmac Studio can handle MDP-compatible slaves from other manufacturers.
Module configuration	A configuration of modules that can be connected to MDP-compatible slaves. The Sysmac Studio can handle module configuration of MDP-compatible slaves from other manufacturers.
EPLAN Electric P8	The electrical design software developed by EPLAN GmbH & Co. KG. Refer to https://www.eplanusa.com/ for details.
Component data	Data available for EPLAN Electric P8.
EPLAN Data Portal	The name of the portal site for electrical design parts that provides component data from various manufacturers.

Revision History

A revision code appears as a suffix to the catalog number on the front and back covers of the manual.

Cat. No. P156-E1-04

↑
Revision code

Revision code	Date	Revised content
01	July 2022	Original production
02	October 2022	Added NX-ECT101 to the supported unit models.
03	April 2023	Added the following models to the supported unit models. NX502-1300, NX502-1400, NX502-1500, NX-HTC3510, NX-HTC4505, NX-ID6342, NX-ID6442, NX-OD6121, NX-OD6256
04	July 2023	Added a description of the following enhanced features of the connector function in Sysmac Studio version 1.55. <ul style="list-style-type: none"> • Expansion of EtherCAT slaves, NX Units, and CJ-series Units that can use the connector function • Support for import of EtherCAT network configurations

1

Overview of the Sysmac Studio/EPLAN Electric P8 Connector Function

This section describes the features of the Sysmac Studio/EPLAN Electric P8 connector function and the software required for using the function.

1-1	Features of the Sysmac Studio/EPLAN Electric P8 Connector Function	1-2
1-2	System Configuration	1-3
1-3	Required Software	1-4

1-1 Features of the Sysmac Studio/ EPLAN Electric P8 Connector Function

The Sysmac Studio/EPLAN Electric P8 connector function (hereinafter called the connector function) imports the controller configuration and device variables from electrical drawings that you created with EPLAN Electric P8 into the Sysmac Studio via an AML file.

In production equipment development sites, there is an issue of duplicate data entry into electrical design software and control design software. You can effectively solve this issue with the connector function.

The connector function provides two types of import depending on the target data to import: the import of *controller configuration and device variables*, and the import of *device variables*. For details on the import methods, refer to the *Sysmac Studio Version 1 Operation Manual (Cat. No. W504)*.

1-2 System Configuration

The connector function consists of a project of EPLAN Electric P8, the electrical design software, component data for OMRON devices imported to EPLAN Electric P8, an AML file exported from EPLAN Electric P8, and a Sysmac Studio project.

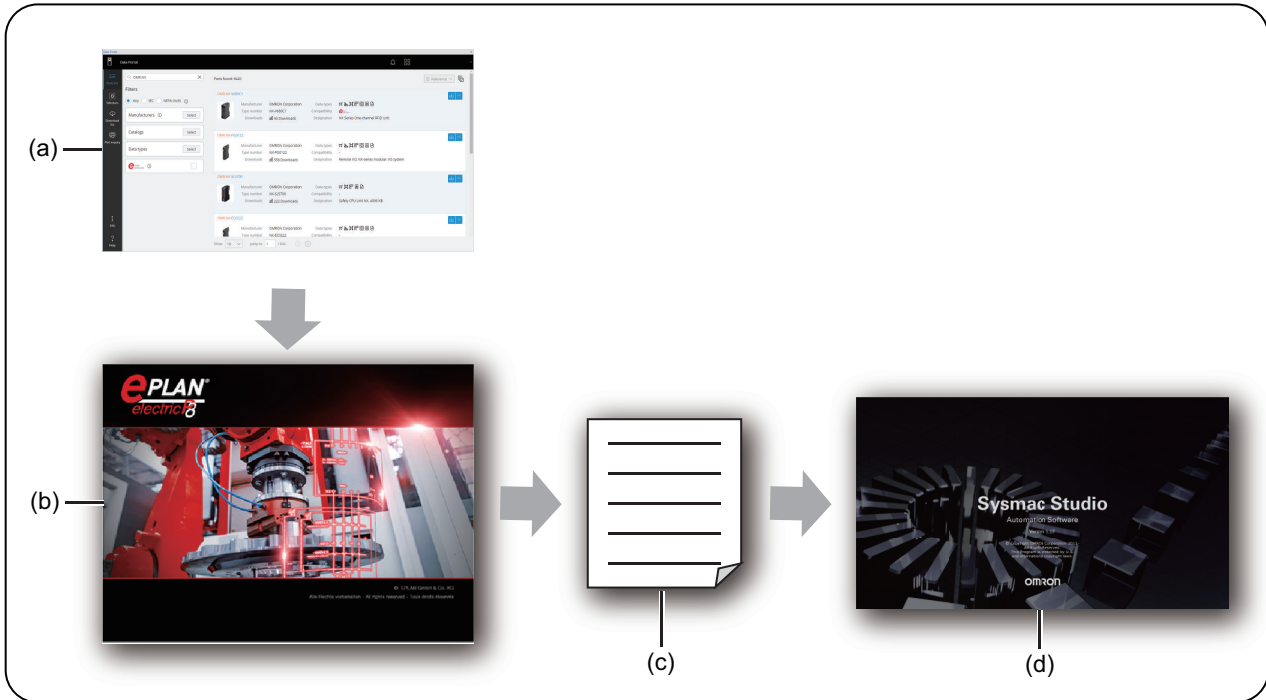

	Item		Description
(a)	EPLAN Data Portal	Component data	Component data for OMRON devices imported to EPLAN Electric P8. The data requires settings for the connector function. Refer to <i>3-2 Setting Component Data</i> on page 3-3.
(b)	EPLAN Electric P8	Electrical drawing project	A project that you create with EPLAN Electric P8. The data requires settings for the connector function. Refer to <i>3-3 Setting the Project</i> on page 3-9.
(c)	---	AML file (.aml)	A file exported from EPLAN Electric P8 that contains information on the controller configuration and device variables. Refer to <i>3-4 Setting the AML File Export</i> on page 3-16 for the export settings.
(d)	Sysmac Studio	Controller project	A project in which to import the AML file. Refer to the <i>Sysmac Studio Version 1 Operation Manual (Cat. No. W504)</i> for how to import an AML file in the Sysmac Studio.

1-3 Required Software

To use the connector function, Sysmac Studio (SYSMAC-SE2□□L) version 1.50 or higher is required. In addition to the Sysmac Studio, the following software and data are also required. They are available from the official websites.

Software	Version	License	Official website
EPLAN Electric P8	2022 Update1 or later	Professional Edition, or Select Edition added with Select+ of Elements	https://www.eplanusa.com/
Component data for OMRON devices that support the connec- tor function	June 2022 or later	Not required	https://www.eplandata.de/portal/

2

Target Data and Preconditions for the Sysmac Studio/EPLAN Electric P8 Connector Function

This section describes the target data and the preconditions for the Sysmac Studio/EPLAN Electric P8 connector function, as well as an example of the development flow with the connector function.

2-1	Target Data for the Sysmac Studio/EPLAN Electric P8 Connector Function	2-2
2-1-1	CPU Units.....	2-2
2-1-2	EtherCAT Slaves	2-3
2-1-3	NX Units	2-6
2-1-4	CJ-series Units	2-9
2-1-5	Device Variables.....	2-10
2-2	Preconditions for the Sysmac Studio/EPLAN Electric P8 Connector Function	2-11
2-2-1	Preconditions for Using the Connector Function.....	2-11
2-2-2	Preconditions for Importing Target Data.....	2-11
2-3	Flow of Development with the Sysmac Studio/EPLAN Electric P8 Connector Function	2-13
2-3-1	Generating a Control Project from Electrical Drawing Data	2-13
2-3-2	Correcting Device Variable Assignments	2-14
2-3-3	Correcting Device Variable Comments	2-14
2-3-4	Changing the Controller Configuration	2-15

2-1 Target Data for the Sysmac Studio/ EPLAN Electric P8 Connector Function

The target of the connector function consists of the information of a CPU Unit, the following Units connected to the CPU Unit, and the associated device variables.

Refer to the reference for each target for details on the supported unit models and device variables.

Target data	Description	Reference
EtherCAT slaves	The models, revisions, and node addresses of EtherCAT slaves are included. The EtherCAT network configuration is excluded. However, Sysmac Studio version 1.55 or higher can import the EtherCAT network configuration.	2-1-2 <i>EtherCAT Slaves</i> on page 2-3
NX Unit configuration	This refers to a Slave Terminal configuration of EtherCAT Coupler Units and a CPU Rack configuration of NX-series CPU Units*1. The NX Unit configuration and the models, unit versions, and unit numbers of NX Units are included.	2-1-3 <i>NX Units</i> on page 2-6
CJ-series Unit configuration	This refers to a CPU/Expansion Rack configuration of NJ-series CPU Units. The CJ-series Unit configuration and the models, unit versions, and slot numbers of CJ-series Units are included.	2-1-4 <i>CJ-series Units</i> on page 2-9
Device variables	Device variables are variables accessing the data in devices in a controller configuration through external interface ports called I/O ports. The variable names and comments of the device variables assigned to the target I/O ports are included.	2-1-5 <i>Device Variables</i> on page 2-10

*1. The NX701 CPU Unit is excluded.



Additional Information

Data that is not included in the above table, such as Option Boards and module configuration of MDP-compatible slaves, are excluded.

2-1-1 CPU Units

The connector function supports the following CPU Unit models.

Model number	Model number	Model number	Model number
NJ101-9000	NX102-9000	NX1P2-1040DT	NX502-1300
NJ101-1000	NX102-1000	NX1P2-1040DT1	NX502-1400
NJ301-1100	NX102-1100	NX1P2-1140DT	NX502-1500
NJ301-1200	NX102-1200	NX1P2-1140DT1	
NJ501-1300	NX102-9020	NX1P2-9024DT	
NJ501-1400	NX102-1020	NX1P2-9024DT1	
NJ501-1500	NX102-1120		
	NX102-1220		

Model number
NX701-1600
NX701-1700
NX701-1620
NX701-1720

2-1-2 EtherCAT Slaves

This section describes the conditions for target EtherCAT slaves for the connector function, examples of where they are excluded from the connection target, and component data that is ready for the connector function.

Conditions for Target EtherCAT Slaves

All of the following conditions must be met in order to use the connector function for EtherCAT slaves.

- The EtherCAT slaves are available in the Sysmac Studio.
- An ESI file for the EtherCAT slaves is installed in the Sysmac Studio.
- In an EPLAN Electric P8 project, the component data and project settings for the EtherCAT slaves conform the rules described in 3-2-2 *OMRON EtherCAT Slaves* on page 3-3 and 3-3-2 *EtherCAT Slaves* on page 3-9.

● Target OMRON Slaves

The target slaves must meet the above conditions, and the following slaves are excluded from the targets.

Model
CJ1W-ECT21*1
NX-ECT101*1

*1. These models are available in CJ-series Unit or NX Unit configurations, although excluded from the targets in EtherCAT configurations.

● Target Other Slaves

Slaves from other vendors on which both the input and output ports can be connected to OMRON slaves support the connector function, as shown below.

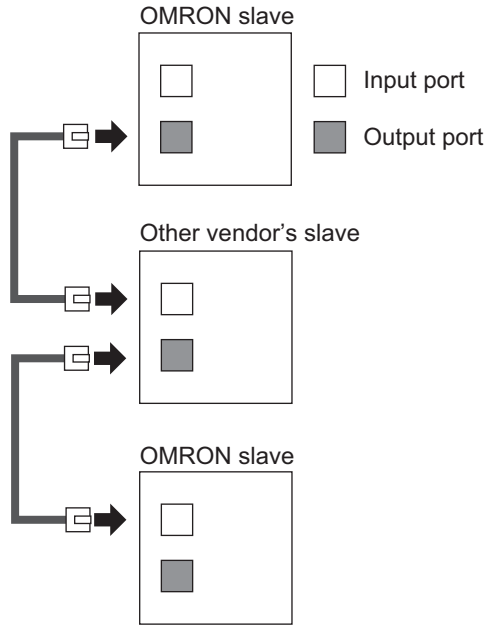

Examples of Other Slaves Excluded from the Target of the Connector Function

Even if meeting the above conditions, slaves from other vendors which correspond to any of the following are ineligible for the connector function.

Ineligible slave units	Conceptual diagrams	
<p>Other vendors' slaves on which at least one of the EtherCAT input and output ports cannot be connected to OMRON slaves</p>	<p>OMRON slave</p> <p>Other vendor's slave</p> <p>□ Input port</p> <p>■ Output port</p> <p>× : Cannot be connected.</p> <p>The input port of the other vendor's slave cannot be connected to the output port of the OMRON slave.</p>	<p>Other vendor's slave</p> <p>OMRON slave</p> <p>□ Input port</p> <p>■ Output port</p> <p>× : Cannot be connected.</p> <p>The output port of the other vendor's slave cannot be connected to the input port of the OMRON slave.</p>
<p>Other vendors' junction slaves (i.e., slaves with two or more EtherCAT output ports)</p>	<p>Other vendor's slave</p> <p>□ Input port</p> <p>■ Output port</p>	

Available Component Data

The OMRON-providing component data of the following slave models have already been setup for using the connector function. Refer to 3-2-2 *OMRON EtherCAT Slaves* on page 3-3 for the settings to use the connector function.

● Coupler Unit

Model number
NX-ECC201
NX-ECC202
NX-ECC203

● Junction Slave

Model number
GX-JC03
GX-JC06

● Servo Drive

Model number	Model number	Model number
R88D-1SAN02H-ECT	R88D-1SN01H-ECT	R88D-1SN10F-ECT
R88D-1SAN04H-ECT	R88D-1SN01H-ECT-03	R88D-1SN10H-ECT
R88D-1SAN08H-ECT	R88D-1SN01L-ECT	R88D-1SN150F-ECT
R88D-1SAN10F-ECT	R88D-1SN02H-ECT	R88D-1SN150H-ECT
R88D-1SAN10H-ECT	R88D-1SN02H-ECT-02	R88D-1SN15F-ECT
R88D-1SAN15F-ECT	R88D-1SN02H-ECT-03	R88D-1SN15F-ECT-02
R88D-1SAN15H-ECT	R88D-1SN02L-ECT	R88D-1SN15H-ECT
R88D-1SAN20F-ECT	R88D-1SN04H-ECT	R88D-1SN20F-ECT
R88D-1SAN20H-ECT	R88D-1SN04H-ECT-02	R88D-1SN20H-ECT
R88D-1SAN30F-ECT	R88D-1SN04H-ECT-03	R88D-1SN30F-ECT
R88D-1SAN30H-ECT	R88D-1SN04L-ECT	R88D-1SN30H-ECT
	R88D-1SN06F-ECT	R88D-1SN55F-ECT
	R88D-1SN08H-ECT	R88D-1SN55H-ECT
	R88D-1SN08H-ECT-02	R88D-1SN75F-ECT
	R88D-1SN08H-ECT-03	R88D-1SN75H-ECT
		R88D-1SN20F-ECT-02

Model number	Model number	Model number
R88D-KN01H-ECT	R88D-KN08H-ECT-L	R88D-KN20H-ECT
R88D-KN01H-ECT-L	R88D-KN10F-ECT	R88D-KN20H-ECT-L
R88D-KN01L-ECT	R88D-KN10F-ECT-L	R88D-KN30F-ECT
R88D-KN01L-ECT-L	R88D-KN10H-ECT	R88D-KN30F-ECT-L
R88D-KN02H-ECT	R88D-KN10H-ECT-L	R88D-KN30H-ECT
R88D-KN02H-ECT-L	R88D-KN150F-ECT	R88D-KN30H-ECT-L
R88D-KN02L-ECT	R88D-KN150F-ECT-L	R88D-KN50F-ECT
R88D-KN02L-ECT-L	R88D-KN150H-ECT	R88D-KN50F-ECT-L
R88D-KN04H-ECT	R88D-KN150H-ECT-L	R88D-KN50H-ECT
R88D-KN04H-ECT-L	R88D-KN15F-ECT	R88D-KN50H-ECT-L
R88D-KN04L-ECT	R88D-KN15F-ECT-L	R88D-KN75F-ECT
R88D-KN04L-ECT-L	R88D-KN15H-ECT	R88D-KN75F-ECT-L
R88D-KN06F-ECT	R88D-KN15H-ECT-L	R88D-KN75H-ECT
R88D-KN06F-ECT-L	R88D-KN20F-ECT	R88D-KN75H-ECT-L
R88D-KN08H-ECT	R88D-KN20F-ECT-L	R88D-KNA5L-ECT

2-1-3 NX Units

This section describes the conditions for target NX Units for the connector function and component data that is ready for the connector function.

Conditions for Target NX Units

The following conditions must be met in order to use the connector function for NX Units.

- In the EPLAN Electric P8 project, the component data and project settings for the NX Units conform the rules described in 3-2-4 *NX Units* on page 3-7 and 3-3-3 *NX Units* on page 3-11.

Available Component Data

The OMRON-providing component data of the following NX Units have already been setup for using the connector function.

● Digital Input Unit and I/O Unit

Model number	Model number	Model number
NX-IA3117	NX-ID4342	NX-ID6142-5
NX-ID3317	NX-ID4442	NX-ID6142-6
NX-ID3343	NX-ID5142-1	NX-ID6342
NX-ID3344	NX-ID5142-5	NX-ID6442
NX-ID3417	NX-ID5342	NX-MD6121-5
NX-ID3443	NX-ID5442	NX-MD6121-6
NX-ID3444		NX-MD6256-5

● Digital Output Unit

Model number	Model number
NX-OC2633	NX-OD5121
NX-OC2733	NX-OD5121-1
NX-OC4633	NX-OD5121-5
NX-OD2154	NX-OD5256
NX-OD2258	NX-OD5256-1
NX-OD3121	NX-OD5256-5
NX-OD3153	NX-OD6121
NX-OD3256	NX-OD6121-5
NX-OD3257	NX-OD6121-6
NX-OD3268	NX-OD6256
NX-OD4121	NX-OD6256-5
NX-OD4256	

● Analog Input Unit

Model number	Model number	Model number	Model number
NX-AD2203	NX-AD4203	NX-TS2101	NX-HAD401
NX-AD2204	NX-AD4204	NX-TS2102	NX-HAD402
NX-AD2208	NX-AD4208	NX-TS2104	
NX-AD2603	NX-AD4603	NX-TS2201	
NX-AD2604	NX-AD4604	NX-TS2202	
NX-AD2608	NX-AD4608	NX-TS2204	
NX-AD3203		NX-TS3101	
NX-AD3204		NX-TS3102	
NX-AD3208		NX-TS3104	
NX-AD3603		NX-TS3201	
NX-AD3604		NX-TS3202	
NX-AD3608		NX-TS3204	

● Analog Output Unit

Model number
NX-DA2203
NX-DA2205
NX-DA2603
NX-DA2605
NX-DA3203
NX-DA3205
NX-DA3603
NX-DA3605

● Position Interface Unit

Model number	Model number
NX-ECS112	NX-EC0112
NX-ECS212	NX-EC0122
NX-PG0112	NX-EC0132
NX-PG0122	NX-EC0142
NX-PG0232-5	NX-EC0212
NX-PG0242-5	NX-EC0222
NX-PG0332-5	
NX-PG0342-5	

● Safety Control Unit

Model number
NX-SID800
NX-SIH400
NX-SL3300
NX-SL3500
NX-SL5500
NX-SL5700
NX-SOD400
NX-SOH200

● Temperature Control Unit

Model number	Model number
NX-TC2405	NX-HTC3510
NX-TC2406	NX-HTC4505
NX-TC2407	
NX-TC2408	
NX-TC3405	
NX-TC3406	
NX-TC3407	
NX-TC3408	

● Other Units

Model number	Model number
NX-CIF101	NX-PD1000
NX-CIF105	NX-PF0630
NX-CIF210	NX-PF0730
NX-ECT101	NX-RS1201
NX-ILM400	NX-TBX01
NX-HB3101	NX-V680C1
NX-HB3201	NX-V680C2
NX-PC0010	
NX-PC0020	
NX-PC0030	

2-1-4 CJ-series Units

This section describes the conditions for target CJ-series Units for the connector function and component data that is ready for the connector function.

Conditions for Target CJ-series Units

The following conditions must be met in order to use the connector function for CJ-series Units.

- In the EPLAN Electric P8 project, the component data and project settings for the CJ-series Units conform the rules described in 3-2-5 *CJ-series Units* on page 3-7 and 3-3-4 *CJ-series Units* on page 3-13.

Available Component Data

The OMRON-providing component data of the following CJ-series Units have already been setup for using the connector function.

● Communications Unit

Model number
CJ1W-CORT21
CJ1W-DRM21
CJ1W-ECT21
CJ1W-EIP21
CJ1W-PNT21
CJ1W-PRM21
CJ1W-PRT21
CJ1W-SCU22
CJ1W-SCU32
CJ1W-SCU42

● Analog I/O Unit

Model number
CJ1W-AD041-V1
CJ1W-AD042
CJ1W-AD04U
CJ1W-AD081-V1
CJ1W-DA021
CJ1W-DA041
CJ1W-MAD42
CJ1W-PDC15
CJ1W-PH41U
CJ1W-DA042V
CJ1W-DA08C
CJ1W-DA08V

● Basic I/O Unit

Model number	Model number	Model number
CJ1W-CT021	CJ1W-IDP01	CJ1W-OD202
CJ1W-IA111	CJ1W-INT01	CJ1W-OD203
CJ1W-IA201	CJ1W-MD231	CJ1W-OD204
CJ1W-ID201	CJ1W-MD232	CJ1W-OD211
CJ1W-ID211	CJ1W-MD233	CJ1W-OD212
CJ1W-ID212	CJ1W-MD261	CJ1W-OD213
CJ1W-ID231	CJ1W-MD263	CJ1W-OD231
CJ1W-ID232	CJ1W-MD563	CJ1W-OD232
CJ1W-ID233	CJ1W-OA201	CJ1W-OD233
CJ1W-ID261	CJ1W-OC201	CJ1W-OD234
CJ1W-ID262	CJ1W-OC211	CJ1W-OD261
	CJ1W-OD201	CJ1W-OD262
		CJ1W-OD263

● Sensor Unit

Model number
CJ1W-V680C11
CJ1W-V680C12

● Temperature Control Unit

Model number
CJ1W-TC003
CJ1W-TC004
CJ1W-TC103
CJ1W-TC104

● I/O Interface Unit

Model number
CJ1W-II101

2-1-5 Device Variables

Refer to the following *IEC 62714 AutomationML I/O Device Port Map Information* for the models and I/O ports that support the connector function for device variables.

Name	Reference	File storage location
IEC 62714 AutomationML I/O Device Port Map Information	AmlIODevicePortMapInformation.html	Help folder under the installation folder of the Sysmac Studio Default location C:\Program Files\OMRON\Sysmac Studio\Help

2-2 Preconditions for the Sysmac Studio/ EPLAN Electric P8 Connector Function

This section describes the preconditions for using the connector function and the preconditions for importing the target data.



Additional Information

Refer to the *Sysmac Studio Version 1 Operation Manual (Cat. No. W504)* for the conditions for the Sysmac Studio to import data.

2-2-1 Preconditions for Using the Connector Function

All of the following conditions must be met to use the connector function.

- In an EPLAN Electric P8 project, the CPU Unit is supported by the connector function. Refer to *2-1-1 CPU Units* on page 2-2 for the CPU Unit models supported by the connector function.
- In the EPLAN Electric P8 project, the component data and project settings for the CPU Unit meet the conditions of the property setting values described in *3-2-1 CPU Units* on page 3-3 and *3-3-1 CPU Units* on page 3-9.
- There is only one CPU Unit in the data to export from EPLAN Electric P8 to the AML file.

2-2-2 Preconditions for Importing Target Data

This section describes the import preconditions for target items in a *controller configuration* and *device variables*.

Preconditions for Importing EtherCAT Slaves

All of the following conditions must be met to import EtherCAT slaves in the Sysmac Studio.

- In an EPLAN Electric P8 project, the EtherCAT slaves are supported by the connector function. Refer to *2-1-2 EtherCAT Slaves* on page 2-3 for the EtherCAT slave models supported by the connector function.

Preconditions for Importing an NX Unit Configuration

All of the following conditions must be met to import an NX Unit configuration with the Sysmac Studio.

- In an EPLAN Electric P8 project, the NX Unit configuration consists of only Units supported by the connector function. Refer to *2-1-3 NX Units* on page 2-6 for the NX Unit models supported by the connector function.

Preconditions for Importing a CJ-series Unit Configuration

All of the following conditions must be met to import a CJ-series Unit configuration with the Sysmac Studio.

- In an EPLAN Electric P8 project, the CJ-series Unit configuration consists of only Units supported by the connector function. Refer to *2-1-4 CJ-series Units* on page 2-9 for the CJ-series Unit models supported by the connector function.

Preconditions for Importing Device Variables

All of the following conditions must be met to import device variables in the Sysmac Studio.

- In an EPLAN Electric P8 project, models and I/O ports that support the connector function for device variables are used. Refer to *2-1-5 Device Variables* on page 2-10 for details.
- In the EPLAN Electric P8 project, component data and project settings for the device variables meet the rules described in *3-2-6 Device Variables* on page 3-8 and *3-3-5 Device Variables* on page 3-15.

2-3 Flow of Development with the Sysmac Studio/EPLAN Electric P8 Connector Function

This section describes four usage examples and the workflows in development using the connector function.

	Usage example	Description	Reference
(a)	Generating a Control Project from Electrical Drawing Data	Create a new project in the Sysmac Studio based on electrical drawing data created on EPLAN Electric P8.	2-3-1 <i>Generating a Control Project from Electrical Drawing Data</i> on page 2-13
(b)	Correcting Device Variable Assignments	After creating a control project in the Sysmac Studio based on electrical drawing data, apply the changes made to device variable assignments in EPLAN Electric P8 to the Sysmac Studio project.	2-3-2 <i>Correcting Device Variable Assignments</i> on page 2-14
(c)	Correcting Device Variable Comments	After creating a control project in the Sysmac Studio based on electrical drawing data, apply the changes made to device variable comments in EPLAN Electric P8 to the Sysmac Studio project.	2-3-3 <i>Correcting Device Variable Comments</i> on page 2-14
(d)	Changing the Controller Configuration	After creating a control project in the Sysmac Studio based on electrical drawing data, apply the changes made to the controller configuration (such as addition of a unit configuration and change of the network wiring) in EPLAN Electric P8 to the Sysmac Studio project.	2-3-4 <i>Changing the Controller Configuration</i> on page 2-15

2

2-3-1 Generating a Control Project from Electrical Drawing Data

2-3-1 Generating a Control Project from Electrical Drawing Data

- 1 Create a new project in EPLAN Electric P8.

What to do	Description	Reference
Creating a project	Create an electrical drawing project.	Refer to the Help page* ¹ in the EPLAN official website.
Setting up the controller configuration and device variables	Configure the settings to use the connector function.	<i>Section 3 Setting EPLAN Electric P8</i> on page 3-1

*1. Refer to *Welcome to the EPLAN Help System* (https://www.eplan.help/en-us/Infoportal/Content/Plattform/2022/Content/htm/EPLAN_Help_k_start.htm).

- 2 Export the controller configuration and device variables from EPLAN Electric P8 to an AML file.

What to do	Description	Reference
Exporting the AML file	Export the AML file used for the connector function.	3-4 <i>Setting the AML File Export</i> on page 3-16

- 3 Import the AML file into the Sysmac Studio.

What to do	Description	Reference
Creating a new project	Create a new project with the target CPU Unit model and version.	Refer to the <i>Sysmac Studio Version 1 Operation Manual (Cat. No. W504)</i> .
Importing the AML file	Import the controller configuration and device variables using the controller configuration and device variable import function.	
Performing the Configurations and Setup and programming	Start designing the control system.	

2-3-2 Correcting Device Variable Assignments

After creating a new project in the Sysmac Studio as described in (a) in 2-3 Flow of Development with the Sysmac Studio/EPLAN Electric P8 Connector Function on page 2-13, perform the following procedure.

- 1 Correct device variable assignments in EPLAN Electric P8.

What to do	Description	Reference
Correcting the project	Correct device variable assignments in the electrical drawing project. (For example, swap the device variables assigned to two I/O terminals.)	<i>Section 3 Setting EPLAN Electric P8</i> on page 3-1

- 2 Export the controller configuration and device variables from EPLAN Electric P8 to an AML file.

What to do	Description	Reference
Exporting the AML file	Export the AML file used for the connector function.	<i>3-4 Setting the AML File Export</i> on page 3-16

- 3 Import the AML file to the Sysmac Studio.

What to do	Description	Reference
Importing the AML file	Changes in device variables will be merged through importing device variables.	Refer to the <i>Sysmac Studio Version 1 Operation Manual (Cat. No. W504)</i> .
Checking the program	Check if the changed device variable assignments have any impact on the program.	

2-3-3 Correcting Device Variable Comments

After creating a new project in the Sysmac Studio as described in (a) in 2-3 Flow of Development with the Sysmac Studio/EPLAN Electric P8 Connector Function on page 2-13, perform the following procedure.

- 1 Correct device variable comments in EPLAN Electric P8.

What to do	Description	Reference
Correcting the project	Change device variable comments in the electrical drawing project.	<i>Section 3 Setting EPLAN Electric P8</i> on page 3-1

- 2** Export the controller configuration and device variables from EPLAN Electric P8 to an AML file.

What to do	Description	Reference
Exporting the AML file	Export the AML file used for the connector function.	<i>3-4 Setting the AML File Export</i> on page 3-16

- 3** Import the AML file to the Sysmac Studio.

What to do	Description	Reference
Importing the AML file	Import the AML file with the option "Import variable comments" checked while importing device variables.	Refer to the <i>Sysmac Studio Version 1 Operation Manual (Cat. No. W504)</i> .

2-3-4 Changing the Controller Configuration

After creating a new project in the Sysmac Studio as described in (a) in 2-3 Flow of Development with the Sysmac Studio/EPLAN Electric P8 Connector Function on page 2-13, perform the following procedure.

- 1** Change the controller configuration in EPLAN Electric P8.

What to do	Description	Reference
Correcting the project	Change the controller configuration in the electrical drawing project.	<i>Section 3 Setting EPLAN Electric P8</i> on page 3-1

- 2** Export the controller configuration and device variables from EPLAN Electric P8 to an AML file.

What to do	Description	Reference
Exporting the AML file	Export the AML file used for the connector function.	<i>3-4 Setting the AML File Export</i> on page 3-16

- 3** Import the AML file in the Sysmac Studio.

What to do	Description	Reference
Importing the AML file	Merge the changes in the controller configuration using the controller configuration import function.	Refer to the <i>Sysmac Studio Version 1 Operation Manual (Cat. No. W504)</i> .

3

Setting EPLAN Electric P8

This section provides information on setting component data, setting the project, and setting the AML file export in EPLAN Electric P8, which are necessary to use the connector function.

3-1	Understanding the EPLAN Electric P8 Setting Items	3-2
3-2	Setting Component Data	3-3
3-2-1	CPU Units.....	3-3
3-2-2	OMRON EtherCAT Slaves	3-3
3-2-3	Other EtherCAT Slaves	3-6
3-2-4	NX Units	3-7
3-2-5	CJ-series Units	3-7
3-2-6	Device Variables.....	3-8
3-3	Setting the Project	3-9
3-3-1	CPU Units.....	3-9
3-3-2	EtherCAT Slaves	3-9
3-3-3	NX Units	3-11
3-3-4	CJ-series Units	3-13
3-3-5	Device Variables.....	3-15
3-3-6	Power Supply Units	3-15
3-4	Setting the AML File Export	3-16

3-1 Understanding the EPLAN Electric P8 Setting Items

This section describes the setting items and rules for component data and projects in EPLAN Electric P8, which are necessary to use the connector function.

Enter the setting values of each property item in EPLAN Electric P8 as described in the *Setting value* column of the table.

● **Device Name**

Set the device as follows.

ID	Property name	Setting value
ID	Property name	Setting value

Item	Description
Device name	Indicates the device name displayed in EPLAN Electric P8.
ID	Indicates the property ID displayed in EPLAN Electric P8.
Property name	Indicates the property name displayed in EPLAN Electric P8.
Setting value	Indicates the value to set for the property in EPLAN Electric P8.

3-2 Setting Component Data

This section describes, for each target data, the setting rules for component data in EPLAN Electric P8, which are necessary for the connector function.

For OMRON devices that support the connector function, EPLAN Data Portal provides component data that complies with the rules (component data last updated in June 2022 or later).

3-2-1 CPU Units

Set the component data for CPU Units as follows.

● PLC Box

Set the PLC box as follows.

ID	Property name	Setting value
20416	PLC type designation	Model name of the CPU Unit Example: "NJ101-9000"
20427	Rack ID	0
20167	CPU	Selected.
20164	Bus coupler / head station	Selected.

● Bus Ports (EtherCAT Ports)

Set the PLC connection points of the built-in EtherCAT port as follows.

ID	Property name	Setting value
20026	Function definition	Network / bus cable connection, general
20308	Bus system	EtherCAT
20447	Bus interface: Name	EtherCAT
20310	Logical network: Bus port is master	Selected.
20448	Bus interface: Main bus port	Selected.

3-2-2 OMRON EtherCAT Slaves

Set the component data for OMRON EtherCAT slaves as follows.

EtherCAT Slaves (Basic)

For basic slave models that have no slave-specific specifications defined, set component data according to the following specifications.

● PLC Box

Set the PLC box as follows.

ID	Property name	Setting value
20416	PLC type designation	Model name of the EtherCAT slave Example: "NX-ECC203"
20427	Rack ID	0
20167	CPU	Not selected.

ID	Property name	Setting value
20164	Bus coupler / head station	Selected.

● **Bus Ports (EtherCAT Ports)**

Set the EtherCAT ports (input ports and output ports) as follows.

ID	Property name	Setting value
20026	Function definition	Network / bus cable connection, general
20308	Bus system	EtherCAT
20447	Bus interface: Name	EtherCAT
20038	Connection point designations (all)	Blank
20310	Logical network: Bus port is master	Not selected.
20448	Bus interface: Main bus port	(a): Selected. (b): Not selected.

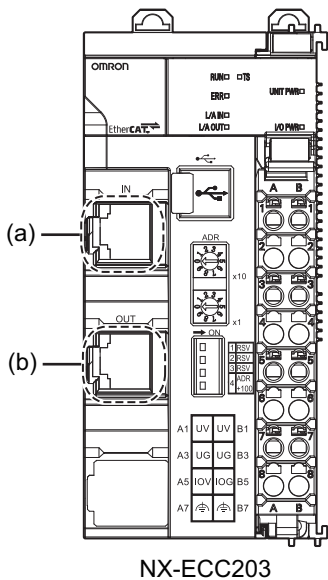

NX-ECC203

Three-port Junction Slaves

● **PLC Box**

Set the PLC box as follows.

ID	Property name	Setting value
20416	PLC type designation	Model name of the three-port junction slave Example: "GX-JC03"
20427	Rack ID	0
20167	CPU	Not selected.
20164	Bus coupler / head station	Selected.

● **Bus Ports (EtherCAT Ports)**

Set the EtherCAT ports of three-port junction slave models as follows.

ID	Property name	Setting value
20026	Function definition	Network / bus cable connection, general

ID	Property name	Setting value
20308	Bus system	EtherCAT
20447	Bus interface: Name	EtherCAT
20406	Plug designation	(a): XIN (b): X2 (c): X3
20038	Connection point designations (all)	Blank
20310	Logical network: Bus port is master	Not selected.
20448	Bus interface: Main bus port	(a): Selected. (b): Not selected. (c): Not selected.

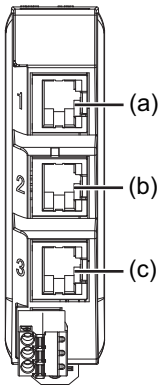

GX-JC03

Six-port Junction Slaves

● PLC Box

Set the PLC box as follows.

ID	Property name	Setting value
20416	PLC type designation	Model name of the six-port junction slave Example: "GX-JC06"
20427	Rack ID	0
20167	CPU	Not selected.
20164	Bus coupler / head station	Selected.

For PLC type designation, set the value corresponding to the model name in the Sysmac Studio.

ID	Property name	Model name (Sysmac Studio)	Setting value
20416	PLC type designation	GX-JC06 (IN, X2, X3) Main device & GX-JC06 (X4, X5, X6) Sub-device	GX-JC06*1
		GX-JC06-H (IN, X2, X3) Main device & GX-JC06-H (X4, X5, X6) Sub-device	GX-JC06-H

*1. GX-JC06 component data is ready for the connector function. Refer to *Available Component Data* on page 2-5 for details.

● Bus Ports (EtherCAT Ports)

Set the PLC connection points for EtherCAT ports of six-port junction slave models as follows.

ID	Property name	Setting value
20026	Function definition	Network / bus cable connection, general
20308	Bus system	EtherCAT
20447	Bus interface: Name	(a): Main device (b): Main device (c): Main device (d): Sub device (e): Sub device (f): Sub device
20406	Plug designation	(a): XIN (b): X2 (c): X3 (d): X4 (e): X5 (f): X6
20038	Connection point designations (all)	Blank
20310	Logical network: Bus port is master	Not selected.
20448	Bus interface: Main bus port	(a): Selected. (b): Not selected. (c): Not selected. (d): Selected. (e): Not selected. (f): Not selected.

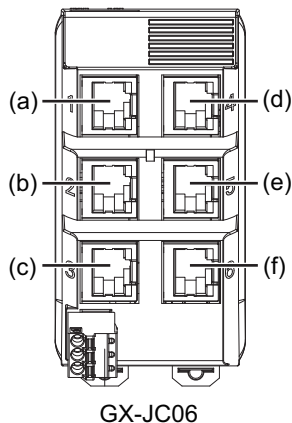

3-2-3 Other EtherCAT Slaves

Set the component data for other vendors' EtherCAT slaves that conform the rules described in *Conditions for Target EtherCAT Slaves* on page 2-3 as follows.

● PLC Box

Set the PLC box as follows.

ID	Property name	Setting value
20416	PLC type designation	Model name of the EtherCAT slave* ¹
20427	Rack ID	0
20167	CPU	Not selected.

ID	Property name	Setting value
20164	Bus coupler / head station	Selected.

*1. Set the same value as the model name displayed in the Sysmac Studio (i.e., the model name defined in the ESI file).

● Bus Ports (EtherCAT Ports)

Set the EtherCAT ports (input ports and output ports) in the same way as *Bus Ports (EtherCAT Ports)* in 3-2-2 OMRON EtherCAT Slaves on page 3-3.

3-2-4 NX Units

Set the component data for NX Units as follows.

NX Units (Excluding Safety CPU Units)

● PLC Box

Set the PLC box as follows.

ID	Property name	Setting value
20416	PLC type designation	Model name of the NX Unit Example: "NX-IA3117"
20427	Rack ID	Blank
20167	CPU	Not selected.
20164	Bus coupler / head station	Not selected.

Safety CPU Units

● PLC Box

Set the PLC box as follows.

ID	Property name	Setting value
20416	PLC type designation	Model name of the Safety CPU Unit Example: "NX-SL3500"
20427	Rack ID	Blank
20167	CPU	Selected.
20164	Bus coupler / head station	Not selected.

3-2-5 CJ-series Units

Set the component data for CJ-series Units as follows.

CJ-series Units (Excluding I/O Interface Units)

● PLC Box

Set the PLC box as follows.

ID	Property name	Setting value
20416	PLC type designation	Model name of the CJ-series Unit Example: "CJ1W-AD042"
20427	Rack ID	Blank
20167	CPU	Not selected.
20164	Bus coupler / head station	Not selected.

I/O Interface Unit CJ1W-II101

● PLC Box

Set the PLC box as follows.

ID	Property name	Setting value
20416	PLC type designation	CJ1W-II101
20167	CPU	Not selected.
20164	Bus coupler / head station	Selected.

3-2-6 Device Variables

Set the component data for models that support the connector function for device variables as follows.

● PLC Connection Points (I/O Ports)

Set the PLC connection points according to the instructions of the following *IEC 62714 AutomationML I/O Device Port Map Information*.

Name	Reference	File storage location
IEC 62714 AutomationML I/O Device Port Map Information	AmlIIODevicePortMapInformation.html	Help folder under the installation folder of the Sysmac Studio Default location C:\Program Files\OMRON\Sysmac Studio\Help

3-3 Setting the Project

This section describes, for each target data, the setting rules for an EPLAN Electric P8 project, which are necessary to use the connector function.



Precautions for Correct Use

Make settings of the PLC box in the PLC box whose *ID: 20122 Main function* check box is checked. Otherwise, the AML file may not be output as created on the project and the data link may fail.



Additional Information

It is recommended to arrange component data in each page as follows according to the recommended settings of EPLAN Electric P8.

- In the Schematic single-line page, arrange the component data of the EtherCAT configuration or the CPU and Expansion Racks configuration, and perform wiring.
- In the Overview page, arrange the component data of the CPU and Expansion Racks configuration or the Slave Terminal configuration.
- In the Schematic multi-line page, set the data of device variables or device variable comments.

It is possible to run the connector function without arranging component data in each page if the conditions described in *2-2 Preconditions for the Sysmac Studio/EPLAN Electric P8 Connector Function* on page 2-11 are met.

When you import an AML file including the controller configuration, a value of the property, 20006 DT (full), will be those defined in IEC81346, and you can confirm them on Sysmac Studio.

3-3-1 CPU Units

Set the CPU Units as follows.

● PLC Box

Set the PLC box as follows.

ID	Property name	Setting value
20161	Configuration project	Any name in a format that meets the EPLAN specification constraints
20408	Station ID	Any name in a format that meets the EPLAN specification constraints
20253 1	CPU: Name [1]	{Name entered in "Configuration project"}.{Name entered in "Station ID"}.{Single-byte number of 1 or more}



Precautions for Correct Use

Do not set the same name in *Configuration project* for more than one CPU Unit in a project. This will result in the AML file containing multiple CPU Units and make it impossible to start the connector function.

3-3-2 EtherCAT Slaves

Set the EtherCAT slaves as follows.

EtherCAT Slaves (Excluding Six-port Junction Slaves)

● PLC Box

Set the PLC box as follows.

ID	Property name	Setting value
20161	Configuration project	Same value as "Configuration project" of the CPU Unit
20408	Station ID	Any name in a format that meets the EPLAN specification constraints and is different from "Station ID" of other component data
20253 1	CPU: Name [1]	Same value as "CPU: Name [1]" of the CPU Unit
20418	Version	<ul style="list-style-type: none"> • OMRON slaves Revision of the EtherCAT slave (This must be a version that exists in the Sysmac Studio and a single-byte number that contains periods as the delimiter.) Example: "1.2" • Other slaves Same value as indicated in the Sysmac Studio Example: "0x00000002" <p>If blank, the component data will be imported with the latest version.</p>

● Bus Ports (EtherCAT Ports)

Set EtherCAT ports (input ports) as follows.

ID	Property name	Setting value
20311	Physical network: Bus ID / item number	(a): EtherCAT node address (Set a single-byte number within the node address range of the CPU Unit that can be set.)

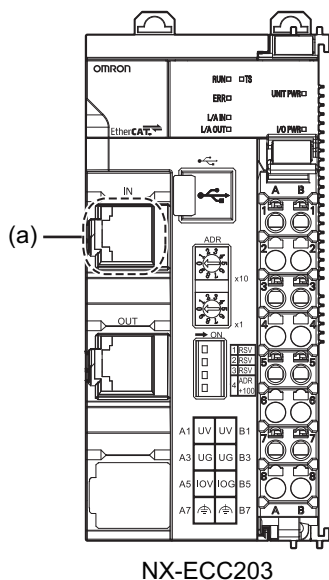

Precautions for Correct Use

To import EtherCAT slaves, you need to set this as follows.

- Place the EtherCAT slaves in the Schematic single-line page.
- Set the node addresses so that they do not conflict with other slaves.

Six-port Junction Slaves

● PLC Box

Set the PLC box as follows.

ID	Property name	Setting value
20161	Configuration project	Same value as "Configuration project" of the CPU Unit
20408	Station ID	Any name in a format that meets the EPLAN specification constraints and is different from "Station ID" of other component data
20253 1	CPU: Name [1]	Same value as "CPU: Name [1]" of the CPU Unit
20418	Version	Revision of the EtherCAT slave (This must be a version that exists in the Sysmac Studio and a single-byte number that contains periods as the delimiter.) If blank, the component data will be imported with the latest version.

● Bus Ports (EtherCAT Ports)

Set the EtherCAT ports as follows.

ID	Property name	Setting value
20311	Physical network: Bus ID / item number	(a): Node address on the input, X2, or X3 side (Set a single-byte number within the node address range of the CPU Unit that can be set.) (b): Node address on the X4, X5, or X6 side (Set a single-byte number within the node address range of the CPU Unit that can be set.)

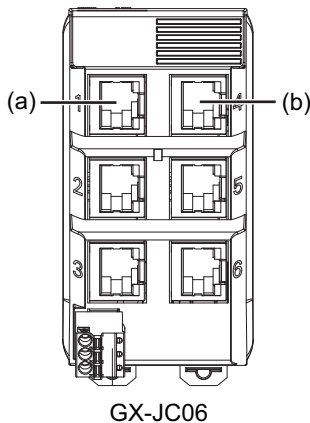

Precautions for Correct Use

To import EtherCAT slaves, you need to set this as follows.

- Place the EtherCAT slaves in the Schematic single-line page.
- Set the node addresses so that they do not conflict with other slaves.

3-3-3 NX Units

Set the component data for NX Units as follows.

NX Units in a CPU Rack Configuration

● PLC Box

Set the PLC box as follows.

ID	Property name	Setting value
20161	Configuration project	Same value as "Configuration project" of the CPU Unit
20408	Station ID	Same value as "Station ID" of the CPU Unit
20427	Rack ID	Blank
20410	PLC card is placed on rack ID	Same value as "Rack ID" of the CPU Unit
20411	Position (slot / module)	NX Unit number (This must be a single-byte number.)
20167	CPU	Not selected.*2
20253 1	CPU: Name [1]	Same value as "CPU: Name [1]" of the CPU Unit*1
20418	Version	Unit version (This must be a version that exists in the Sysmac Studio and a single-byte number that contains periods as the delimiter.) If blank, the component data will be imported with the latest version.

*1. For Safety CPU Units, Safety Digital Input Units, and Safety Digital Output Units, leave the properties blank.

*2. The set value for the Safety CPU Unit is selected by default.



Precautions for Correct Use

To import an NX Unit configuration, you need to set this as follows.

- Set NX Unit numbers so that they do not conflict in the CPU Rack configuration.
- Set NX Unit numbers so that they are sequential numbers that start from 1.

NX Units in a Slave Terminal Configuration

● PLC Box

Set the PLC box as follows.

ID	Property name	Setting value
20161	Configuration project	Same value as "Configuration project" of the CPU Unit
20408	Station ID	Same value as "Station ID" of the EtherCAT Coupler Unit to which the NX Unit belongs
20427	Rack ID	Blank
20410	PLC card is placed on rack ID	Same value as "Rack ID" of the EtherCAT Coupler Unit
20411	Position (slot / module)	NX Unit number (This must be a single-byte number.)
20253 1	CPU: Name [1]	Same value as "CPU: Name [1]" of the CPU Unit*1
20418	Version	Unit version (This must be a version that exists in the Sysmac Studio and a single-byte number that contains periods as the delimiter.) If blank, the component data will be imported with the latest version.

*1. For Safety CPU Units, Safety Digital Input Units, and Safety Digital Output Units, leave the properties blank.

**Precautions for Correct Use**

To import an NX Unit configuration, you need to set this as follows.

- Set NX Unit numbers so that they do not conflict in the Slave Terminal configuration.
- Set NX Unit numbers so that they are sequential numbers that start from 1.

3-3-4 CJ-series Units

Set the component data for CJ-series Units as follows.

CJ-series Units in a CPU Rack Configuration (Excluding I/O Control Units)**● PLC Box**

Set the PLC box as follows.

ID	Property name	Setting value
20161	Configuration project	Same value as "Configuration project" of the CPU Unit
20408	Station ID	Same value as "Station ID" of the CPU Unit
20427	Rack ID	Blank
20410	PLC card is placed on rack ID	Same value as "Rack ID" of the CPU Unit
20411	Position (slot / module)	Slot number
20253 1	CPU: Name [1]	Same value as "CPU: Name [1]" of the CPU Unit
20418	Version	Version (This must be a version that exists in the Sysmac Studio and a single-byte number that contains periods as the delimiter. To specify the version of a Unit whose version is indicated as "---" on the Sysmac Studio, set "---" or "0.0".) If blank, the component data will be imported with the latest version.

**Precautions for Correct Use**

To import a CJ-series Unit configuration, you need to set this as follows.

- Set slot numbers so that they do not conflict in the CPU Rack configuration.
- Set slot numbers so that they are sequential numbers that start from 0.
- Set slot numbers so that they are not more than the maximum unit number of the CPU Rack for NJ-series CPU Units.

I/O Control Unit CJ1W-IC101**● PLC Box**

Leave all the setting values of the PLC box blank.

ID	Property name	Setting value
20161	Configuration project	Blank
20408	Station ID	Blank
20427	Rack ID	Blank
20410	PLC card is placed on rack ID	Blank
20411	Position (slot / module)	Blank

ID	Property name	Setting value
20253 1	CPU: Name [1]	Blank

I/O Interface Unit CJ1W-II101

● PLC Box

Set the PLC box setting values as follows.

ID	Property name	Setting value
20161	Configuration project	Same value as "Configuration project" of the CPU Unit
20408	Station ID	Same value as "Station ID" of the CPU Unit
20427	Rack ID	Rack number
20410	PLC card is placed on rack ID	Blank
20411	Position (slot / module)	Blank
20253 1	CPU: Name [1]	Same value as "CPU: Name [1]" of the CPU Unit



Precautions for Correct Use

To import a CJ-series Unit configuration, you need to set this as follows.

- Set rack numbers so that they are sequential numbers that start from 1.
- Set not more than three CJ1W-II101 Units for one CPU Unit.

CJ-series Units in an Expansion Rack Configuration (Excluding I/O Interface Units)

● PLC Box

Set the PLC box setting values as follows.

ID	Property name	Setting value
20161	Configuration project	Same value as "Configuration project" of the CPU Unit
20408	Station ID	Same value as "Station ID" of the CPU Unit
20427	Rack ID	Blank
20410	PLC card is placed on rack ID	Same value as "Rack ID" of the CJ1W-II101 to which the CJ-series Unit belongs
20411	Position (slot / module)	Slot number
20253 1	CPU: Name [1]	Same value as "CPU: Name [1]" of the CPU Unit
20418	Version	Version (This must be a version that exists in the Sysmac Studio and a single-byte number that contains periods as the delimiter. To specify the version of a Unit whose version is indicated as "---" on the Sysmac Studio, set "---" or "0.0".) If blank, the component data will be imported with the latest version.



Precautions for Correct Use

To import a CJ-series Unit configuration, you need to set this as follows.

- Set slot numbers so that they do not conflict in the Expansion Rack configuration.
- Set slot numbers so that they are sequential numbers that start from 0.
- Set slot numbers so that they are not more than the maximum unit number of the CPU Rack for NJ-series CPU Units.

3-3-5 Device Variables

Set the component data for models that support the connector function for device variables as follows.

● PLC Connection Points

Set the target I/O ports as follows.

ID	Property name	Setting value
20402	Symbolic address	Device variable name
20011	Function text	Device variable comment



Precautions for Correct Use

- If the device variable name does not observe the Sysmac Studio naming rules, the following error message will be displayed. Name it according to the naming rules given in the message. If you do not observe the naming rules, you will need to correct the component data due to a global variable name error after importing it into the Sysmac Studio.

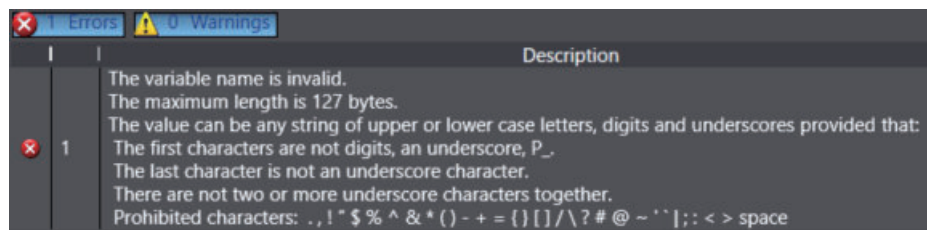

- To enter a device variable comment, you need to set the device variable name.
- Set device variable names so that they do not conflict in the controller configuration. Device variables with conflicting variable names will not be imported.
- When ID: 20438 Deactivated I/O connection point is selected, device variables will not be imported to the Sysmac Studio even if their device variable names and device variable comments are entered.

3-3-6 Power Supply Units

● PLC Box

Leave all the setting values of the PLC box blank.

ID	Property name	Setting value
20161	Configuration project	Blank
20408	Station ID	Blank
20427	Rack ID	Blank
20410	PLC card is placed on rack ID	Blank
20411	Position (slot / module)	Blank
20253 1	CPU: Name [1]	Blank

3-4 Setting the AML File Export

This section provides information on setting the AML file export.

To set the AML file export, from the **File** menu of EPLAN Electric P8, select **Export – Project data – PLC data** to open the **Export PLC data** dialog box*¹.

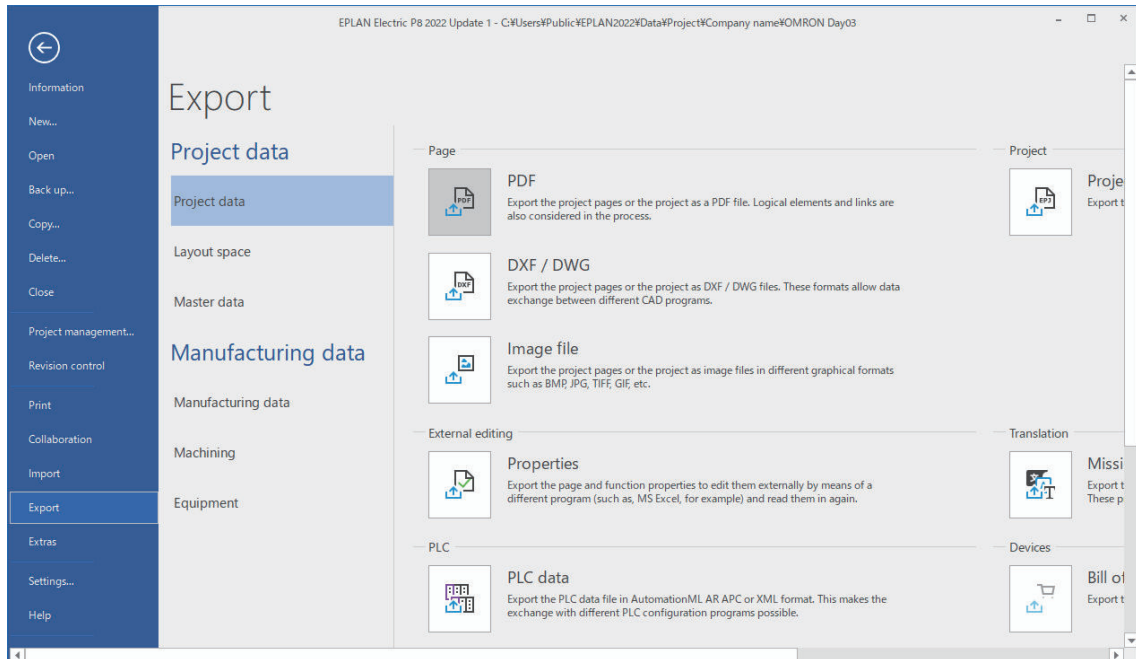

*¹. When a menu bar compatible with EPLAN Electric P8 version 2.9 or earlier is displayed, the dialog box can also be displayed from **Project data – PLC – Export data** on the menu bar.

To export the controller configuration and device variables from EPLAN Electric P8 to an AML file, be sure to follow the setting instructions below.

Item	Setting
Configuration project	Select the same value as the <i>Configuration project</i> of the target CPU Unit.
Language	Select the language of the device variable comments to connect.
PLC configuration program	Select <i>EPLAN Electric P8</i>
Format of export file	Select <i>AutomationML AR APC V1.2.0</i> .
Options	Click the Options button to open the Settings: AutomationML AR APC export dialog box, and then set the items as follows. <ul style="list-style-type: none"> • Export port-specific interconnection: Selected*¹ • Export accessories: Selected • Export drives: Not selected • Export device-specific configuration values: Selected

*¹. Do not select the check box if you do not export the connection order of EtherCAT slaves.

Note: Do not use this document to operate the Unit.

OMRON Corporation Industrial Automation Company

Kyoto, JAPAN

Contact : www.ia.omron.com

Regional Headquarters

OMRON EUROPE B.V.

Wegalaan 67-69, 2132 JD Hoofddorp
The Netherlands
Tel: (31) 2356-81-300 Fax: (31) 2356-81-388

OMRON ELECTRONICS LLC

2895 Greenspoint Parkway, Suite 200
Hoffman Estates, IL 60169 U.S.A.
Tel: (1) 847-843-7900 Fax: (1) 847-843-7787

OMRON ASIA PACIFIC PTE. LTD.

438B Alexandra Road, #08-01/02 Alexandra
Technopark, Singapore 119968
Tel: (65) 6835-3011 Fax: (65) 6835-3011

OMRON (CHINA) CO., LTD.

Room 2211, Bank of China Tower,
200 Yin Cheng Zhong Road,
PuDong New Area, Shanghai, 200120, China
Tel: (86) 21-6023-0333 Fax: (86) 21-5037-2388

Authorized Distributor:

©OMRON Corporation 2022-2023 All Rights Reserved.
In the interest of product improvement,
specifications are subject to change without notice.

Cat. No. P156-E1-04 0723