

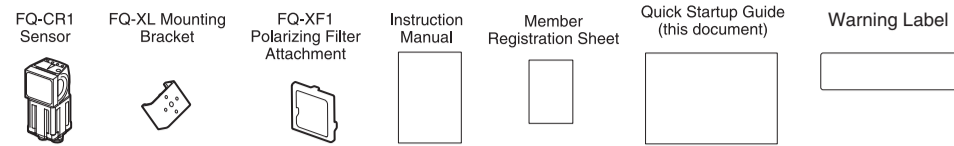

## Box Contents

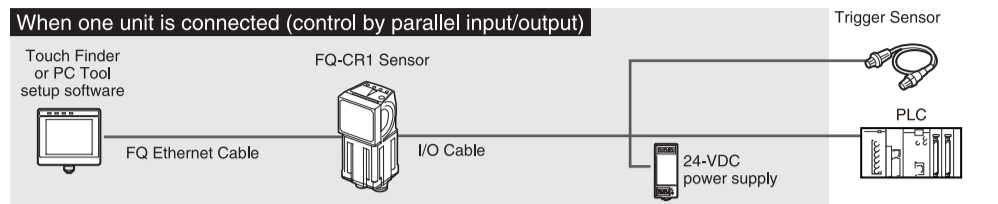

## System Overview



### Multiple Connections

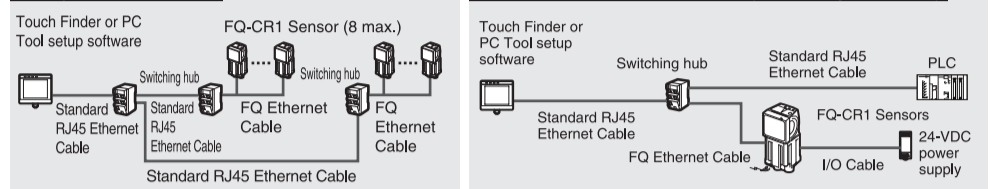

Product	Model number	Remarks
FQ-CR1 Sensor	FQ-CR1 <span style="border: 1px solid black; padding: 0 2px;"> </span> <span style="border: 1px solid black; padding: 0 2px;"> </span> <span style="border: 1px solid black; padding: 0 2px;"> </span> <span style="border: 1px solid black; padding: 0 2px;"> </span> <span style="border: 1px solid black; padding: 0 2px;"> </span> -M	This is the FQ-CR1 Sensor.
Touch Finder	FQ <span style="border: 1px solid black; padding: 0 2px;"> </span> <span style="border: 1px solid black; padding: 0 2px;"> </span> -D <span style="border: 1px solid black; padding: 0 2px;"> </span> <span style="border: 1px solid black; padding: 0 2px;"> </span>	This is a setup console. (Software version must be 1.6 or higher)
PC Tool	---	The PC Tool can be used instead of the Touch Finder. (Software version must be 1.6 or higher) If you register as a member, you can download the free PC Tool as a special service to purchasers. Refer to the Member Registration Sheet for member registration procedures and the download procedure for special member software.
FQ Ethernet Cable	FQ-WN0 <span style="border: 1px solid black; padding: 0 2px;"> </span> <span style="border: 1px solid black; padding: 0 2px;"> </span>	Connects the Sensor to the Touch Finder or computer.
Standard RJ45 Ethernet Cable	---	Connects the switching hub to the Touch Finder or computer. (STP (shielded twisted-pair) cable, category 5e or 6, impedance: 100 Ω)
I/O Cable	FQ-WD0 <span style="border: 1px solid black; padding: 0 2px;"> </span> <span style="border: 1px solid black; padding: 0 2px;"> </span>	Connects the Sensor to the power supply and external devices.

## Flow of Switching Operation

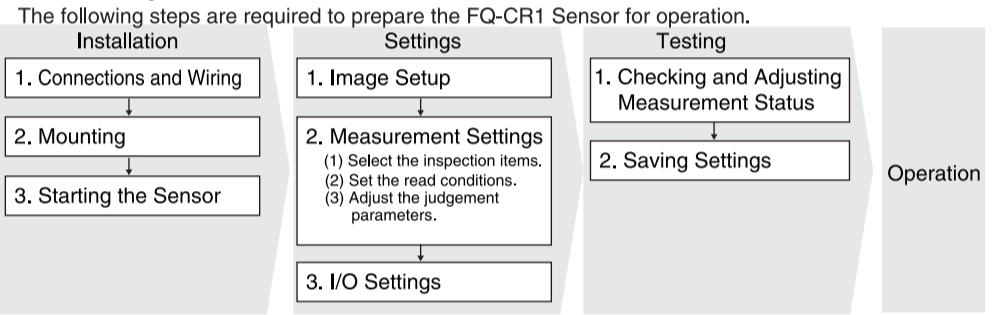

## 1. Installation

### 1-1 Connections and Wiring

1 Connect the Sensor to the Touch Finder or Computer via the FQ-WN0   Ethernet Cable.

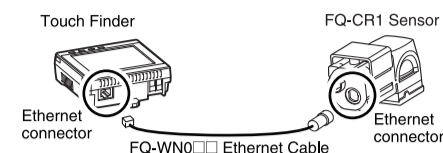

2 Connect the I/O Cable to the Sensor.

The I/O Cable includes lines for the power supply and I/O. Connect the required lines.

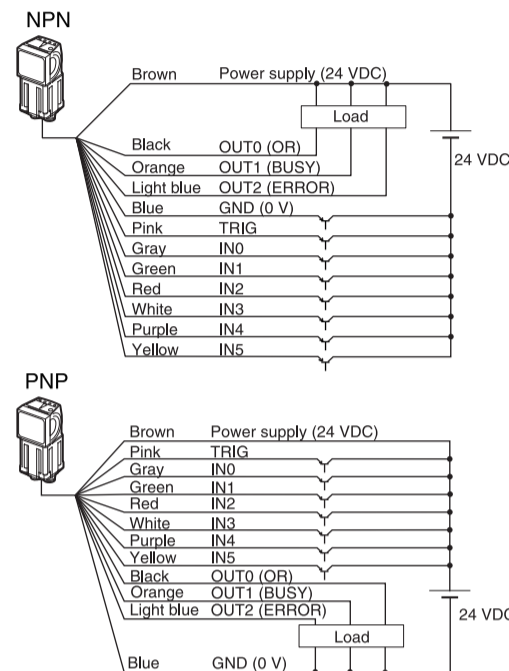

I/O	Signal	Function
Inputs	TRIG	Measurement trigger input (single)
	IN0 to IN5	Command input
Outputs	OUT0 (OR)	Overall judgement output
	OUT1 (BUSY)	Indicates that processing is in progress.
	OUT2 (ERROR)	Indicates an error has occurred.

### Example 1

Here, measurements are performed when the trigger signal is input and the overall judgement is output.

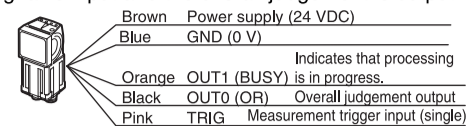

The TRIG signal is not received while the BUSY signal is ON. Turn ON the TRIG signal while the BUSY signal is OFF.

### Important

- When brightness correction mode is ON, the brightness is stable but a delay of 25 ms occurs. Refer to the *User's Manual* for details.
- Use a no-contact output device (e.g., SSR or PLC transistor output) for the TRIG signal. If a contact (e.g., relay) is used, contact bound may cause the trigger to be input again during execution of a measurement.

### Example 2

Here, a process switching signal is input from an external device to switch the scene.

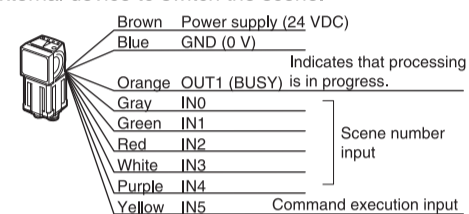

### 3 Connect a power supply to the Touch Finder.

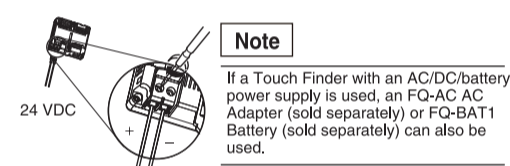

### 1-2 Mounting

1 Check the mounting position.

Use the optical charts in the *User's Manual* and check the installation distance to be sure it is suitable for the field of view to be measured.

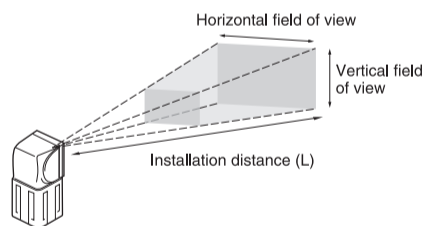

The horizontal field of view is given in the optical chart. The vertical field of view is approx. 60% of the horizontal field of view.

Example: FQ-CR10050F

For a 30-mm field of view, the Sensor must be installed at an installation distance of 115 mm.

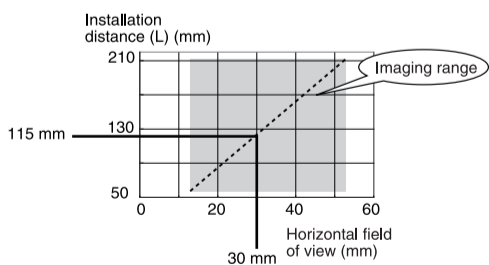

2 Attach the Mounting Bracket to the Sensor and mount the Sensor at the correct position.

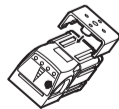

### Installing the PC Tool

To use the PC Tool, register as a member, download the PC Tool, and install the PC Tool on your computer.

Use the following network settings on your computer if you connect the computer directly to the Sensor. If you connect the computer and Sensor through a hub using a DHCP server, the following IP address does not need to be set.

- IP address: 10.5.5.101
- Subnet mask: 255.255.255.0

### 1-3 Starting the Sensor

1 Power ON the Sensor.

2 Power ON the Touch Finder.

Turn ON the power switch on the side of the Touch Finder, too.

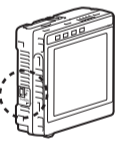

To use the PC Tool, click [Program] - [OMRON] - [FQ] - [PC tool for FQ] from the Windows Start Menu.

Confirm that the software version for the Touch Finder and also the PC Tool is version 1.6 or higher.

Select the language to display on the Touch Finder.



If more than one Sensor is connected, a display will appear to select the Sensor to be set. Select the Sensor.

The following initial display will appear when the Sensor is selected.



## 2. Settings

### 2-1 Image Setup

Make sure the image is stable and adjust the brightness and image input timing.

1 Focus the image.

Press [Camera setup].

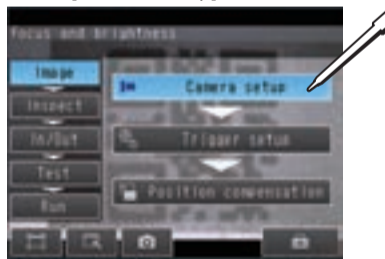

The camera image will be displayed.



The higher the value, the better the focus.

Use the focus adjustment screw on the top of the Sensor to focus the image.

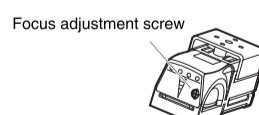

2 Adjust the brightness.

The FQ-CR1 Sensor will automatically adjust the brightness according to the measurement object. If the resulting brightness is not suitable, it can be adjusted manually.

Press [◀] and then [Brightness].



Adjust the brightness with the slider at the bottom of the display. You can also press [AUTO] to automatically set the brightness according to the image.



Press [OK].

### Note

- Turning ON the [HDR] function improves the image quality for shiny objects. Refer to the *User's Manual* for details.
- Attach the enclosed Polarizing Filter if the image is blurred by reflections.

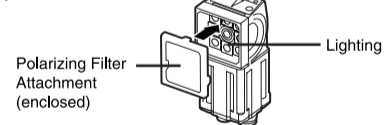

3 Adjust the image input timing.

Adjust the delay from when the trigger is input until the image is input. Press [Trigger setup].

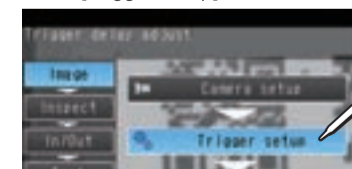

Press [Trigger delay].

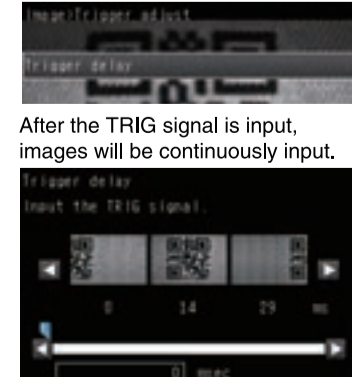

Select the image that was taken with the best timing. Press [OK].

#### 4 Set up the Position Compensation.

To enable measurement even if the location of the measurement object is not consistent, register a mark that exists on all measurement objects. This function is called position compensation.

Press [Position compensation].



Press [Mode on/off] and then [ON]. Then press [Settings].

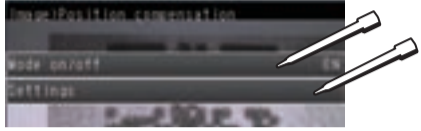

Press [Teach].

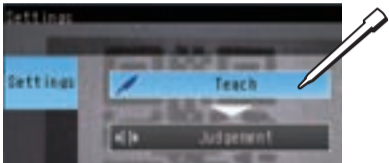

Place the object that is to be used as the measurement reference in front of the camera. Move the rectangle so that the characteristic part for position compensation is inside it.



Drag a corner to size the rectangle.  
Drag the rectangle to move it.

Check the area, press the [OK] Button, and then press the [TEACH] Button. The characteristic part and reference position for position compensation will be registered.

Press [OK].

### 2-2 Measurement Settings

Select an item that is appropriate for the purpose of measurement, and set the measurement settings. The procedure for automatically setting the 2D-code measurement settings is shown here.

#### 1 Select the inspection items.

Ex.: Reading 2D-codes

Press [Inspect]. Next, touch [Inspection]. Press an unused inspection item number and then press [Add item.] on the menu.

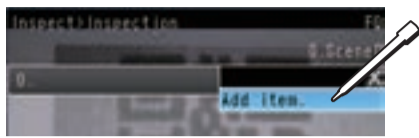

Touch [2D-code].

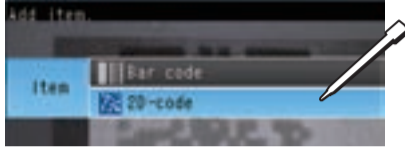

#### 2 Set the 2D-code read conditions.

Press [Teach].



Confirm that the 2D-code is inside the green frame and touch [OK].



Drag a corner to size the rectangle.  
Drag the rectangle to move it.

Press [Teach].

If reading is successful, the 2D-code type and num. of characters will display.

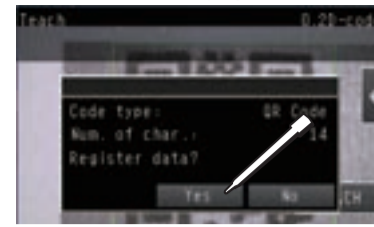

Touch [Yes].

Press [Back] to end teaching.

The text string read in as master data will display.



Press [Back].

To register additional master data, follow the procedure shown below.

- Touch the master data to be registered.
- Touch [Automatic Registration].
- Touch [TEACH].

To manually register master data, follow the procedure shown below.

- Touch the master data to be registered.
- Touch [Manual Registration].
- Input the text string to be registered.

If reading is unsuccessful, check the condition of the workpiece and the lighting, and then perform the teaching process again.

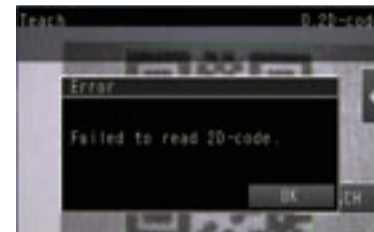

#### 3 Adjust the judgement parameters.

Press [Judgement].

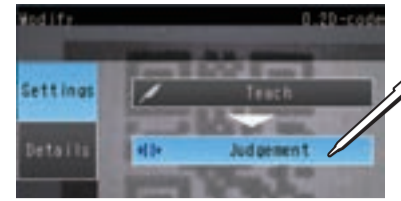

Adjust the judgement parameters for the num. of characters and the text string while inputting images of a number of sample items.



Press [OK].

### 2-3 I/O Settings

The data that is output to external devices and the input signal assignments can be changed. (Changes are not normally required.) For example, the following can be input or output.

- Judgements for individual inspection items can be output.
- If you want to output characters
- If you want to output data externally

Refer to the *User's Manual* for details.

## 3. Testing

Tests are made with some samples to see if correct measurements are possible. When Test Mode is entered, images are measured continuously. A trigger input is not required. Measurement results are only displayed. They are not output to an external device.

## 4. Operation

#### 1 Switch to the Run Mode display.

Press [Run]. Then press [Switch to Run mode].



#### 2 Save the settings.

Press [Yes].

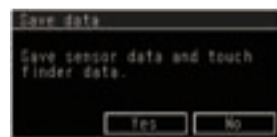

#### 3 Execute measurements.

Measurements will be executed according to the trigger signal input. And the result of measurement will be output to an external device.



#### 1 Perform tests.

Press [Test]. Then press [Continuous test].

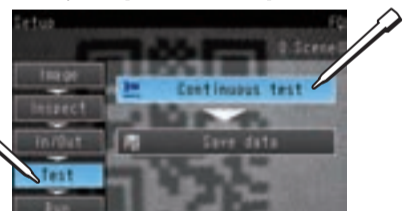

Press [Graphics+Details].

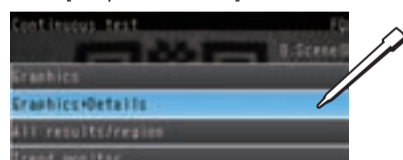

Continuous measurements will be performed. Input images of some samples to see if the judgements are correct.



#### 2 If correct judgements are not made, adjust the judgement parameters.

Press [Adjust judgement].

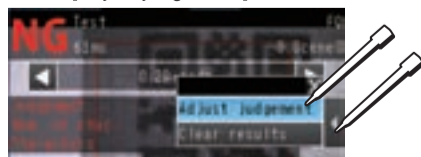

#### Note

There are six types of displays that can be used, as shown below. Press the [OK] Button and then press [Select display] to display the following selections.

Displaying the Most Recent Measurement Values



Displaying Measurement Values Over Time

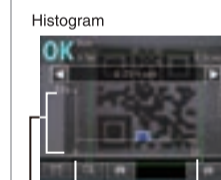

Variations in Measurement Values

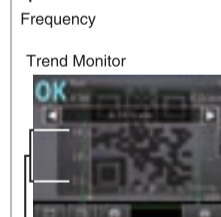

Graphics + Details

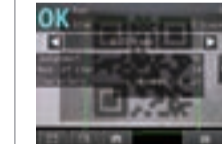

Trend Monitor

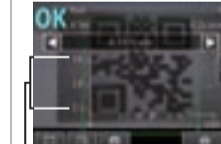

Measurement values

All Results/Region

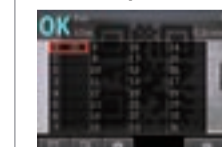

Statistical Data

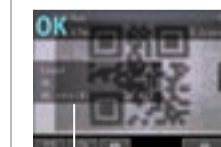

Measurement values since power was turned ON

#### Note

- To return to the Setup Display, press the [Sensor settings] Button and then press [Sensor settings].
- To switch to another Sensor, press the [Switch sensor] Button and then press [Switch sensor].

## Menu Structure

