

**Model KE1  
DeviceNet  
Communication Units  
User's Manual**

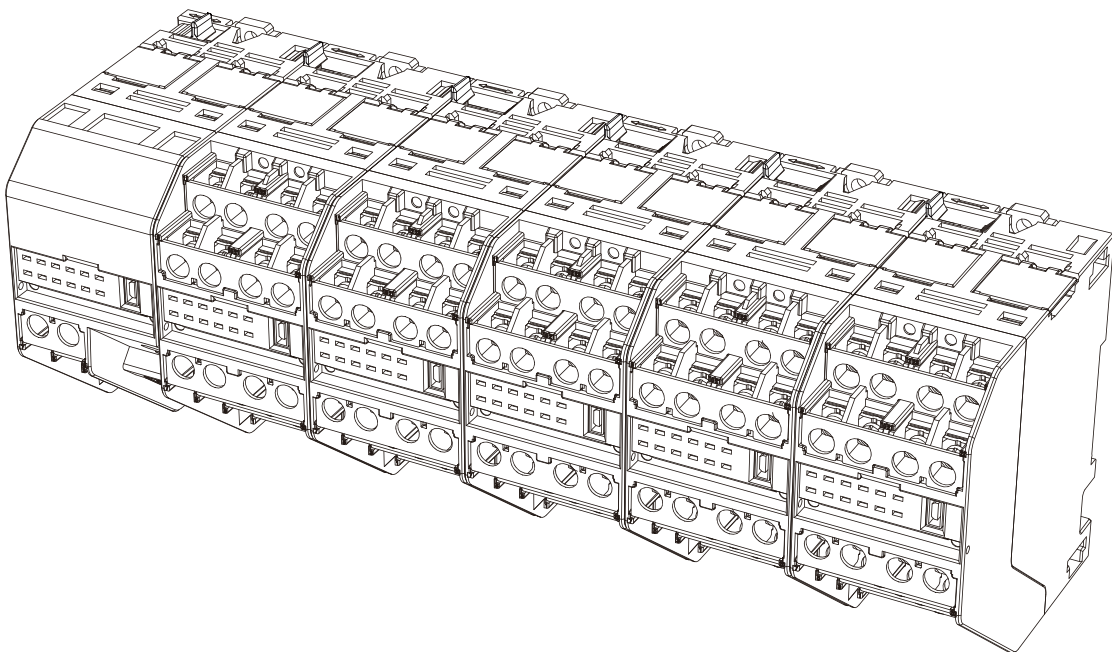



# INTRODUCTION

---

Thank you for purchasing the Model KE1-DRT-FLK.  
This product is a unit for DeviceNet communications.

This User's Manual describes the information on the functions, performances, and usage necessary for using this product.

When using this product, be sure to observe the following points.

- Only the experts having practical knowledge of electricity shall be allowed to handle this product.
- Go through and fully understand this User's Manual, and use the product correctly.
- Keep this manual at hand for quick reference.

# Items on which you Agree by Using this Product

## 1. Warranty details

### (1) Warranty period

The warranty period for this product is one year from purchase or delivery to a specified site.

### (2) Warranty scope

If faults attributable to Omron arise with this product within the above warranty period, a replacement product will be provided or repair services will be provided for free at the site where the user purchased the product.

However, if any of the following are the cause of a fault, the product will be out of warranty.

- a) If the product is used in a condition, environment, or method other than that stated in the catalog or Instruction Manual.
- b) If the fault is caused by a factor(s) other than the one arising from this product
- c) If the fault is due to modification or repair other than those by Omron
- d) If the product is used in a way different from the one in which the product is intended to be used.
- e) If the fault could not be predicted under the level of science and technology available at the time of shipment from Omron.
- f) If the fault arises from a factor(s) not attributable to Omron, such as natural disasters

The warranty stated in this manual refers to the warranty for a single unit of this product, and the damage induced by faults of this product is not covered by the warranty.

## 2. Restriction of responsibility

- (1) Omron shall not bear any responsibility for special damage, indirect damage, or consequential damage arising from this product.

- (2) This product can be programmed. Omron shall not bear any responsibility for the programs written by anybody other than Omron and the results arising from the programs.

## 3. Conditions for product compatibility

- (1) When using this product with other products, you must check the applied standards and regulations or restrictions. You also must check whether this product is compatible with the systems, machines, and equipment to be used. Without these checks made, Omron shall not bear any responsibility for the compatibility of this product.

- (2) In the case of the following applications, consult our sales representative and then use the specifications and other necessary documents for your confirmation. In addition, provide an adequate margin of rating and performance. Take safety measures, e.g., use of a safety circuit, to minimize risks even if a failure occurs.

- a) Outdoor use and use in which the product is subject to potential chemical contamination or electric interference, or use under conditions or environments other than those described in the catalog or User's Manual
- b) Use in equipment such as nuclear control facilities, incineration facilities, train/aviation/vehicle systems, medical machines, entertainment machines,

safety devices, and facilities subject to the regulations of administrative bodies and individual industries.

- c) Systems, machines, and devices which may cause harm to human lives and assets
- d) Facilities which require a high level of reliability such as gas, water, and electricity supply systems, and 24-hour continuous operation system.
- e) Other purposes requiring a high level of safety in accordance with the above a) to d)

- (3) If the product is used for purposes which may cause harm to human lives or assets, you must notify concerned parties of such risks related to overall systems, and you must check beforehand that a redundant design is used to ensure required safety, and that the product is wired and installed appropriately for the intended purpose in the whole system.
- (4) Application examples described in the catalogue are for reference purposes. When using an example of application, you must check the functions and safety of your related machinery and equipment.
- (5) You must fully understand the prohibited items and points to note in use and follow the instructions, so that there will be no unexpected damage to you or to third parties due to incorrect use of this product.

#### 4. Specification Change

The specifications of this product and the accessories described in the catalogue and Instruction Manual are subject to change as necessary for reasons such as improvements. Please contact your Omron sales representative to check the current specifications of this product.

#### 5. Applicable scope

The details given above are applied to the trade and use of the product within Japan. For information on the trade and use outside Japan, please contact your Omron sales representative.

#### About this manual

- (1) No part of this manual may be copied or reproduced in any form without prior written permission from OMRON.
- (2) Regarding the contents of this manual, specifications are subject to change without prior notice for improvements.
- (3) OMRON takes all possible measures to ensure the contents of this manual. However, if you find any part unclear or incorrect, contact our branch office or sales office listed at the end of this manual. Please also let us know of the manual number given at the end of the manual.

# Safety Precautions

## ● Signs for Safe Use and Their Meanings

For your safe use of Model KE1-DRT-FLK, this manual uses the indications and symbols below to notify you of the points to note.

The points to note shown here indicate the important details on safety. You must adhere to them.





The indications and symbols are shown below.

### Meaning of warning









**Handling this product incorrectly is dangerous. This may lead to slight or moderate injuries or damage to objects.**

## ● Explanation of Symbols

Symbol	Meaning
	<ul style="list-style-type: none"><li>● Do not dismantle Dismantling of the equipment may cause accidents such as electric shock.</li></ul>
	<ul style="list-style-type: none"><li>● General mandatory notice Instructions on usage restriction are given to prevent injuries and damage to objects.</li></ul>
	<ul style="list-style-type: none"><li>● Avoid electric shock hazards. Calling of attention to electric shock hazards under certain conditions.</li></ul>
	<ul style="list-style-type: none"><li>● Avoid explosion hazards. Calling of attention to explosion hazards under certain conditions.</li></ul>

● Display of warning

 <b>Caution</b>	
<p>In rare cases, damage to objects may arise from ignition.            Be sure to tighten terminal screws with the specified tightening torque.            Recommended tightening torque for terminal screws: <b>0.69 to 0.88 N·m</b>            After tightening the screws, check that they are vertical.</p>	
<p>In rare cases, an explosion may cause a moderate/slight injury or damage to objects. Do not use the product at a place where it is exposed to flammable or explosive gas.</p>	
<p>In rare cases, breakage or explosion may occur.            Use the power supply voltage that meets the requirement of the specifications.</p>	
<p>In rare cases, electric shocks may occur.            Before setting the configuration switch and routing cables, turn off the power of the units and the facility that incorporates the units.</p>	
<p>In rare cases, electric shocks may occur.            Do not touch the terminals under energized conditions.</p>	
<p>In rare cases, electric shocks, slight injuries, ignition, or equipment failure may occur.            Do not dismantle, repair or alter the product.</p>	

# Safety Points

To prevent operation failure, malfunction, and bad effects on the performance and functionality of the product, observe the following points.

- 1) Do not use or store (including transportation) this product under the following places.
  - Greatly subject to vibrations and shocks
  - Unstable place
  - Temperature and humidity are out of the specified range.
  - Subject to great change in temperature and humidity and possible condensation and Freezing
  - Exposed to direct sunlight
  - Outdoor or exposed to wind and rain
  - Subject to static electricity or noise
  - Exposed to splashes of water, oil and salt water
  - Exposed to corrosive gas (sulfidizing gas, ammonia gas, etc.)
  - Exposed to much dust or iron powder
  - Subject to electric fields or magnetic fields
- 2) Fix the DIN rail tightly with screws. Make sure that the product is attached to the DIN rail firmly. Loose attachment may cause the DIN rail, main unit of the product and/or wires to be detached due to vibrations and shocks.
- 3) Use the DIN rail of 35 mm in width (Model PFP-50N/-100N manufactured by Omron).
- 4) For the wiring of the main unit of the product, use a crimp-on terminal suitable for M3.5 screw.
- 5) Before allowing current to flow, confirm that there is no error in the specifications and wiring.
- 6) Please read carefully and understand this manual before handling and maintaining the product. Not doing so may result in electric shock, injury, accident, fault, or malfunction.
- 7) To allow the operator to immediately turn off the power supply, install a switch or a circuit breaker meeting the requirements of IEC60947-1 and IEC60947-3 in a recognizable way.
- 8) After understanding the instructions provided in this manual, configure the equipment.
- 9) When installing this product, keep it away as far as possible from the equipment generating strong high-frequency noise or surges.
- 10) Before touching this product, discharge static electricity by contacting an earthed metal object or the like.
- 11) To prevent induction noise, the wiring system of the main unit must be separate from the high-voltage and large-current power lines. Avoid arranging the wires for the main unit parallel to power lines and using power lines in the wiring of the main unit. Separate piping and ductwork and the use of shield wires are effective.
- 12) Do not install this product at a location adjacent to a heat-generating device (device with coil and winding, etc.).
- 13) Do not allow any metal, conductor and swarf produced during the processing for installation to enter this product.
- 14) Do not use thinner when cleaning the product. Use commercially-available alcohol.
- 15) The power source that provides power supply voltage and electric wires that supply



input must meet the requirements. Otherwise, failure, burnout, and electric shock may occur.

- 16) When installing the product on the wall surface, eliminate looseness by tightening screws. Loose attachment may cause the main unit of the product and wires to be detached due to vibrations and shocks.
- 17) When multiple units are used, slide the lateral connection hook until you hear a click.
- 18) When installing the product in a DIN rail, slide the DIN hook until you hear a click.
- 19) Do not block the vent and the surrounding areas of this product to allow heat radiation.
- 20) Check terminal numbers to ensure correct wiring. Connect nothing to the unused terminals.
- 21) This product is classified as "Class A" (industrial environment product). Using this product in residential environment may cause radio frequency interference. In that case, an appropriate measure against the interference must be taken.

# Requests for Installation

- For long term use

Use this product under the following temperature and humidity ranges.

Temperature: -10 to +55°C (No freezing and condensation)

Humidity: 25 to 85% RH

If the product is installed inside a panel, the temperature around this product (instead of the temperature around the panel) must be within 55°C.

This product has the life determined by the lives of the electronic components used inside the product. The life of the components depends on the ambient temperature. Increase in ambient temperature shortens the life and decrease in temperature lengthens the life. Therefore, lowering the internal temperature of the product can lengthen its life. If multiple Model KM1/KE1 units are installed close to each other or they are arranged in two levels, forced cooling, e.g. supply of air to the product with a fan, should be considered.

- To make the product less subject to peripheral noise

To prevent induction noise, the wiring system of the terminal block of this product must be separate from the high-voltage and large-current power lines. Avoid arranging the wires for the main unit parallel to power lines and using power lines in the wiring of the main unit. Separate piping and ductwork and the use of shield wires are effective.

Attach a surge absorber or a noise filter to the peripheral devices generating noise (motor, transformer, solenoid, and magnet coil in particular that have an inductance component).

Keep this product away from the equipment generating very high-frequency noise (high-frequency welder, high-frequency sewing machine, etc.) or the equipment generating surges.

# Precautions for Use

- 1) Configure respective settings properly according to the objects to be controlled.
- 2) Do not hold and drag a cable.
- 3) When disposing of this product, handle it appropriately as industrial waste.

# Before Using this Product

Please read the manual provided with this product and confirm the following points.

When	Check item	Details
Purchase of product	Product appearance	After purchasing the product, check the packing carton for dents. If any damage is found on the product, it may not be able to measure properly depending on the damaged location.
	Type and specifications of product	Check that the specifications of the purchased product meet your requirements.
Installation	Installation site	Select the location that allows heat radiation from the product without objects blocking the product. Do not block the vent of the main unit. When installing the product close to another unit, consider forced cooling such as supply of air to the product with a fan.
At the time of wiring	Terminal wiring	Do not apply excessive stress when tightening screws. Make sure that screws are locked in place after tightening them at the specified torque (0.69 to 0.88 N·m). Check the polarity of a terminal to ensure correct wiring.
	Power supply and voltage input	Ensure correct wiring for power supply and voltage input. Incorrect wiring may cause the destruction of internal circuits.
Usage environment	Ambient temperature	The usage temperature for this product is -10 to +55°C (no freezing and condensation). To extend the lifetime of this product, install it in a way to lower ambient temperature. If the product is subject to high temperature, consider forced cooling where a fan is used.
	Vibration/impact	Check that the installation environment meets the specified requirements on vibrations and impact. (As a conductor causes the product to be exposed to vibrations and impact, keep the product away from a conductor as much as possible.)
	Intrusion of foreign substance	Install the product in a place where no liquid and foreign substance can enter. If corrosive gases including sulfur and chlorine are generated, remove the source of the gas generation and install a ventilation fan to improve the environment.

# Relevant Manuals

## ■ Model KM1/KE1 Related Manuals

Man. No.	Type	Manual name	Description
KANC-701	Model KM1-□□□□□□-FLK	Model KM1 Smart Electric Energy Monitor User's Manual	Describes the overview, features, functions and settings of Model KM1.
SGTE-717	Model KE1-□□□□□□-FLK Model KE1-□□□□□□	Model KE1 Smart Measurement and Monitoring Instrument User's Manual	Describes the overview, features, functions and settings of Model KE1.
SGTE-719	Model KM1/KE1	Model KM1/KE1 Smart Electric Energy Monitor Smart Measurement and Monitoring Instrument Communication Manual	Describes the details of the communications in the Model KM1/KE1 series.
GAMS-010	Model KM1/KE1	KM1/KE1-Setting User's Manual	Describes how to use the configuration tools and configure the settings in the Model KM1/KE1 series.

## ■ DeviceNet Related Manuals (Master Unit)

Man.No.	Type	Manual name	Description
SCCC-308	Model CS1W-DRM21 (-V1) Model CJ1W-DRM21 Model CVM1-DRM21-V1 Model C200HW-DRM21-V1 Model 3G8F7-DRM21	DeviceNet User's Manual	Describes the configuration of the DeviceNet network and topology. This manual also describes the details on the installation method and specifications of the connection related devices such as cables and connectors used in the network and the method of supplying power for communications.
SBCD-312	Model CVM1-DRM21 Model CVM1-DRM21-V1 Model C200HW-DRM21 Model C200HW-DRM21-V1	DeviceNet master unit for CVM1/CV DeviceNet master unit for SYSMAC α/C200HS User's Manual	Describes the details on the specifications, functions, and usage of the DeviceNet master units for CVM1/CV and for SYSMAC α/C200HS.
SBCD-314	Model CS1W-DRM21 (-V1) Model CJ1W-DRM21	DeviceNet unit for CS/CJ series User's Manual	Describes the details on the specifications, functions, and usage of the DeviceNet unit for CS/CJ series. (The DeviceNet unit for CS/CJ series can function as both master and slave simultaneously.)

## ■ PLC Related Manuals

Man.No.	Type	Manual name	Description
SBCA-349	Model CJ2H-CPU□□-EIP	CJ Series CJ2 CPU Unit User's Manual Hardware Version	Provides the following information on the CJ2 CPU unit. <ul style="list-style-type: none"> <li>· I want to know about the overview/features.</li> <li>· I want to know about the configuration of the basic system.</li> <li>· I want to know the name and function of each section.</li> <li>· I want to know about the installation and setting procedures.</li> <li>· I want to know about troubleshooting.</li> </ul> Use this manual together with User's Manual Software Version (SBCA-350).
SBCA-350	Model CJ2H-CPU□□-EIP	CJ Series CJ2 CPU Unit User's Manual Software Version	Provides the following information on the CJ2 CPU unit. <ul style="list-style-type: none"> <li>· I want to know about how the CPU unit operates.</li> <li>· I want to know about the internal memory.</li> <li>· I want to know about the program.</li> <li>· I want to know about available settings.</li> <li>· I want to know about the built-in CPU function.</li> </ul> Use this manual together with User's Manual Hardware Version (SBCA-349).
SBCA-312	Model CJ1G/H-CPU□□H Model CJ1M-CPU□□ Model CJ1G-CPU□□	CJ Series User's Manual Setup Version	Provides the following information on the PLC of CJ series. <ul style="list-style-type: none"> <li>· I want to know about the overview/features.</li> <li>· I want to design a system configuration.</li> <li>· I want to install and route wires.</li> <li>· I want to know about the assignment of I/O memory.</li> <li>· I want to know about troubleshooting.</li> </ul> Use this manual together with User's Manual Programming Version (SBCA-313).
SBCA-301	Model CS1G/H-CPU□□H Model CS1G/H-CPU□□-V1 Model CS1D-CPU□□H Model CS1D-CPU□□S	CS Series User's Manual Setup Version	Provides the following information on the PLC of CS series. <ul style="list-style-type: none"> <li>· I want to know about the overview/features.</li> <li>· I want to design a system configuration.</li> <li>· I want to install and route wires.</li> <li>· I want to know about the assignment of I/O memory.</li> <li>· I want to know about troubleshooting.</li> </ul> Use this manual together with User's Manual Programming Version (SBCA-313).
SBCA-313	Model CJ2H-CPU□□-EIP Model CS1G/H-CPU□□H Model CS1G/H-CPU□□-V1 Model CS1D-CPU□□H Model CS1D-CPU□□S Model CJ1G/H-CPU□□H Model CJ1M-CPU□□ Model CJ1G-CPU□□	CS/CJ Series User's Manual Programming Version	Provides the following information on the PLC of CS/CJ series. <ul style="list-style-type: none"> <li>· I want to write a computer program.</li> <li>· I want to know about the task function.</li> <li>· I want to know about the file memory function.</li> <li>· I want to know about available functions.</li> </ul> Use this manual together with User's Manual Setup Version (CS series: SBCA-301, CJ series: SBCA-312).
SBCA-351	Model CJ2H-CPU□□-EIP Model CJ1G/H-CPU□□H Model CJ1M-CPU□□ Model CJ1G-CPU□□ Model CS1G/H-CPU□□H Model CS1G/H-CPU□□-V1 Model CS1D-CPU□□H Model CS1D-CPU□□S	CS/CJ/NSJ Series Command Reference Manual	Describes the details of each instruction word. Use this manual together with the following User's Manuals when writing a program. <ul style="list-style-type: none"> <li>· CJ series: User's Manual Hardware Version (SBCA-349), User's Manual Software Version (SBCA-350) User's Manual Setup Version (SBCA-312), User's Manual Programming Version (SBCA-313)</li> <li>· CS series: User's Manual Setup Version (SBCA-301), User's Manual Programming Version (SBCA-313)</li> </ul>

# Manual Revision History

Manual revision number is given at the end of the catalogue number described on the bottom left of the front and back covers of the manual.

Catalog No. SGTE-717C

Revision symbol

Revision symbol	Revised year and month	Reason for revision and revised page
A	May 2012	First edition
B	July 2012	Correction of error in writing
C	Dec. 2012	Correction of error in writing Addition of explanation

# Table of Contents

<b>INTRODUCTION .....</b>	<b>I</b>
<b>Items on which you Agree by Using this Product.....</b>	<b>II</b>
<b>Safety Precautions.....</b>	<b>IV</b>
<b>Safety Points .....</b>	<b>VI</b>
<b>Requests for Installation.....</b>	<b>VIII</b>
<b>Precautions for Use.....</b>	<b>IX</b>
<b>Before Using this Product.....</b>	<b>IX</b>
<b>Relevant Manuals.....</b>	<b>X</b>
<b>Manual Revision History .....</b>	<b>XII</b>
<b>Table of Contents .....</b>	<b>XIII</b>
<b>Chapter 1 Overview.....</b>	<b>1-1</b>
1. 1 Features and System Configuration .....	1-2
■Features .....	1-2
■Overview of Communication Function of DeviceNet Communication Unit .....	1-3
■System Configuration .....	1-5
1. 2 Specifications.....	1-6
■DeviceNet Communication Specifications.....	1-6
■Connection Specifications .....	1-7
■General Specifications.....	1-7
1. 3 Connection of Model KM1/KE1 Unit .....	1-8
■Identification of Model KM1/KE1 Unit and Number of Connected Units .....	1-8
■Types of Model KM1/KE1 Units.....	1-8
1. 4 Initial Settings of Model KM1/KE1 Units .....	1-9
■Setting by Explicit message .....	1-9
<b>Chapter 2 Instruction for Use .....</b>	<b>2-1</b>
2. 1 Setup Procedure.....	2-2
2. 2 Procedure to Be Taken Before Operation .....	2-3
■Selection of Simple Assignment.....	2-3
■Selection of I/O Assignment with Configurator .....	2-4
<b>Chapter 3 Name of Each Part, Installation, and Wiring .....</b>	<b>3-1</b>
3. 1 Name and Function of Each Part.....	3-2
■Name of Each Part .....	3-2
■Display.....	3-4
■Switch Setting .....	3-5
3. 2 Installation .....	3-6
■Attachment of DeviceNet Communication Unit and Model KM1/KE1 Unit.....	3-6
■Attachment to DIN Rail .....	3-8
3. 3 Wiring of DeviceNet Cables .....	3-10

■Preparation of DeviceNet Communication Cable .....	3-10
■Connection to DeviceNet Communication Unit.....	3-12
3. 4 Wiring for Model KM1/KE1 Units .....	3-13
<b>Chapter 4 Remote I/O function .....</b>	<b>4-1</b>
4. 1 Overview of Assignment Method .....	4-2
■Overview.....	4-2
■Assignment Procedure.....	4-3
4. 2 Simple Assignment.....	4-4
■Setting of Assignment Data .....	4-5
■Area Configuration for Simple Assignment .....	4-6
4. 3 I/O Assignment with Configurator .....	4-8
■Setting of Assignment Data .....	4-8
■List of Assignment Options .....	4-12
4. 4 Assignment of Assignment Data to High-Order Device .....	4-14
■Assignment to High-Order Device.....	4-14
■Setting by DeviceNet Configurator .....	4-14
■Connection Setting for Dividing IN Area into Two.....	4-16
<b>Chapter 5 Operations with Configurator.....</b>	<b>5-1</b>
5. 1 List of Operations with Configurator.....	5-2
5. 2 Operation from Device Parameter Edit Window of DeviceNet Communication Unit.....	5-3
■Preparations of Configurator Connection .....	5-3
■Displaying Device Parameter Edit window.....	5-4
■Setting of Description on DeviceNet Communication Unit .....	5-5
5. 3 Maintenance Mode Screen .....	5-6
■What is Maintenance Mode Screen? .....	5-6
<b>Chapter 6 Explicit Message Communication .....</b>	<b>6-1</b>
6. 1 Overview of Explicit Message Communication .....	6-2
■What is Explicit Message Communication?.....	6-2
■Basic Format of Explicit Message .....	6-3
6. 2 CompoWay/F Communication Command Destined for Model KM1/KE1 (Embedding of Explicit Message) .....	6-6
■Overview of Explicit Message Communication with Model KM1/KE1 Unit.....	6-6
■CompoWay/F ASCII Command .....	6-8
■List of FINS-mini Commands.....	6-9
<b>Chapter 7 Communication Capability.....</b>	<b>7-1</b>
7. 1 Remote I/O Communication Capability .....	7-2
■Input/Output Response Time.....	7-2
■CompoWay/F Communication Cycle Time and Refresh Processing Time .....	7-7
■Network Having Multiple Masters Connected .....	7-9
■System Startup Time .....	7-10
7. 2 Capability of Message Communication .....	7-11
■Message Communication Time.....	7-11



Chapter 8 Troubleshooting and Maintenance.....	8-1
8. 1 Meaning of LED Indication and Troubleshooting.....	8-2
8. 2 Maintenance of Equipment.....	8-3
■Cleaning Method.....	8-3
■Inspection Method .....	8-3
■Handling of Unit at Replacement .....	8-4
A Appendix .....	A-1
List of Models of Connection Related evices .....	A-2
■DeviceNet Communication Unit.....	A-2
■Model KM1/KE1.....	A-2
■DeviceNet Communication Cable and Connector with Cable .....	A-2
■DeviceNet Communication Connector.....	A-3
■Crimp-on Terminal for DeviceNet Communication Cable .....	A-3
■Terminator.....	A-4
■T-Branch Tap.....	A-4
■Shield Type T-Branch Connector.....	A-4
■1-Branch Tap Dedicated for Power Supply .....	A-4
■Inquiries on Product Manufactured by Other Company.....	A-5
Explanation of Technical Terms .....	A-6

## Index



# Chapter 1 Overview

1.1	Features and System Configuration .....	1-2
■	Features.....	1-2
●	Applications of DeviceNet functions.....	1-2
■	Overview of Communication Function of DeviceNet	
	Communication Unit.....	1-3
●	Remote I/O communication.....	1-3
●	Explicit message communication.....	1-4
■	System Configuration .....	1-5
●	Basic configuration .....	1-5
1.2	Specifications .....	1-6
■	DeviceNet Communication Specifications .....	1-6
■	Connection Specifications.....	1-7
■	General Specifications.....	1-7
1.3	Connection of Model KM1/KE1 Unit.....	1-8
■	Identification of Model KM1/KE1 Unit and Number of Connected Units .....	1-8
■	Types of Model KM1/KE1 Units .....	1-8
1.4	Initial Settings of Model KM1/KE1 Units.....	1-9
■	Setting by Explicit message .....	1-9

# 1.1 Features and System Configuration

## ■ Features

The DeviceNet communication unit allows a high-order device (PLC, PC) to collect different types of measurement data from multiple units of Model KM1/KE1 series and to write parameters via DeviceNet. Neither measurement of voltage, current, and other things nor alarm detection is available.

### ● Applications of DeviceNet functions

[Management of multiple units of Model KM1/KE1 with high-order device (PLC, PC) in an integrated manner]

One DeviceNet communication unit can be connected to one measurement master of Model KM1/KE1 series. (The DeviceNet communication unit can be connected to a high-order device (PLC, PC) as DeviceNet slave.) As a high-order device (PLC, PC) can have up to two DeviceNet communication units to be connected to it, multiple DeviceNet communication units and other type of slaves can be managed collectively.

[Remote I/O communication function]

The remote I/O communication function allows a high-order device (PLC, PC) and DeviceNet communication units to share input and output. The remote I/O communication function allows assigning different types of measurement data of Model KM1/KE1 units to a high-order device (PLC, PC) and sending/receiving them without using a program.

- Remote I/O communication available without configurator  
The DeviceNet communication unit allows basic data such as measurement data of Model KM1/KE1 to be assigned to a high-order device (PLC, PC) without a configurator. (Selection of simple assignment)  
"Simple Assignment" is available with the switch setting in the main unit.
- Data you wish to assign selectable  
You can select desired data to be assigned to a high-order device (PLC, PC) using a configurator or USB/RS-485 communication. (Selection of manual assignment)

[Explicit message communication function]

This function allows performing a variety of operations such as reading and writing intended parameters like measurement data with the issue of a command from a high-order device (PLC, PC). These operations are available by embedding a CompoWay/F communication command into an Explicit message.

[Model KM1/KE1 setting/monitor with configurator]

The configurator (Ver. 2.44 or later) or CX-Integrator (Ver. 2.2 or later) allows creating and downloading the device parameters of DeviceNet communication units (configurations of DeviceNet communication units).

- \* To use the configurator of Ver. 2.44, download and install the extension module for the Model KE1 DeviceNet communication units from our homepage (<http://www.fa.omron.co.jp>).  
<http://www.fa.omron.co.jp/>  
For information on the installation procedure, refer to the explanation provided in the download page.
- \* CX-Programmer allows monitoring the measurement data and parameters of Model KM1/KE1 in real time.

[Automatic detection of communication speed]

The DeviceNet communication unit automatically detects the communication speed of a high-order device (PLC, PC).

When you change the communication speed setting of a high-order device (PLC, PC), restart the entire system.

## Overview of Communication Function of DeviceNet Communication Unit

### Remote I/O communication

The data of a DeviceNet communication unit is shared between the unit and the IN and OUT areas of a high-order device (PLC, PC) via DeviceNet. Up to 61 channels are available in the IN area for the DeviceNet communication unit and only one channel in the OUT area. Soft reset is always assigned to the OUT area.

Status of ongoing communication and measurement data of Model KM1/KE1 units are assigned to the IN area. If the DeviceNet unit for CS/CJ series is used as high-order device (PLC, PC), the IN area can be divided into two.

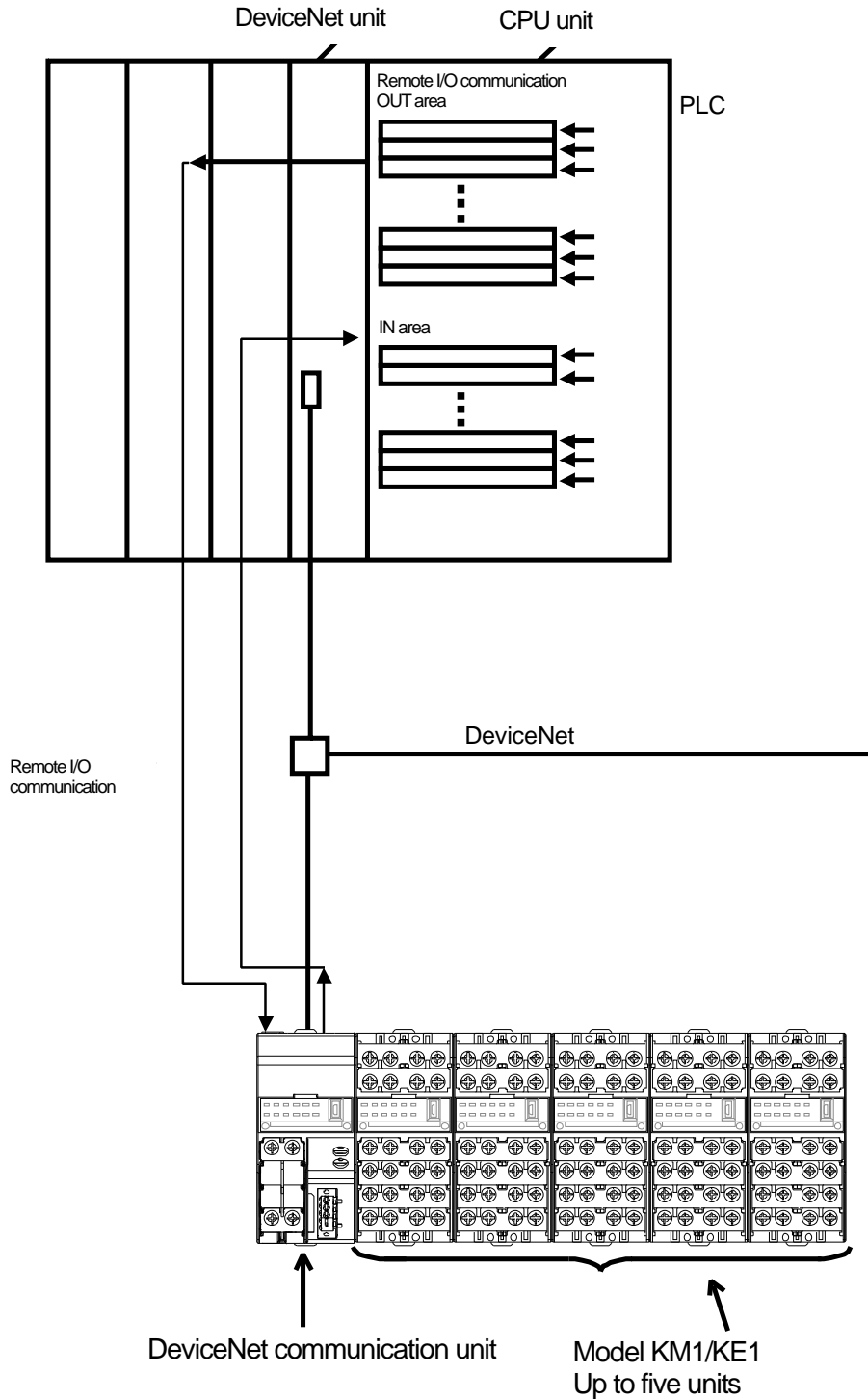

● Explicit message communication

A high-order device (PLC, PC) issues a command of an Explicit message to the DeviceNet communication unit to allow reading and writing intended parameters of the connected Model KM1/KE1 units.

This command allows issuing the existing CompoWay/F communication command (Explicit message communication format) for Model KM1/KE1.

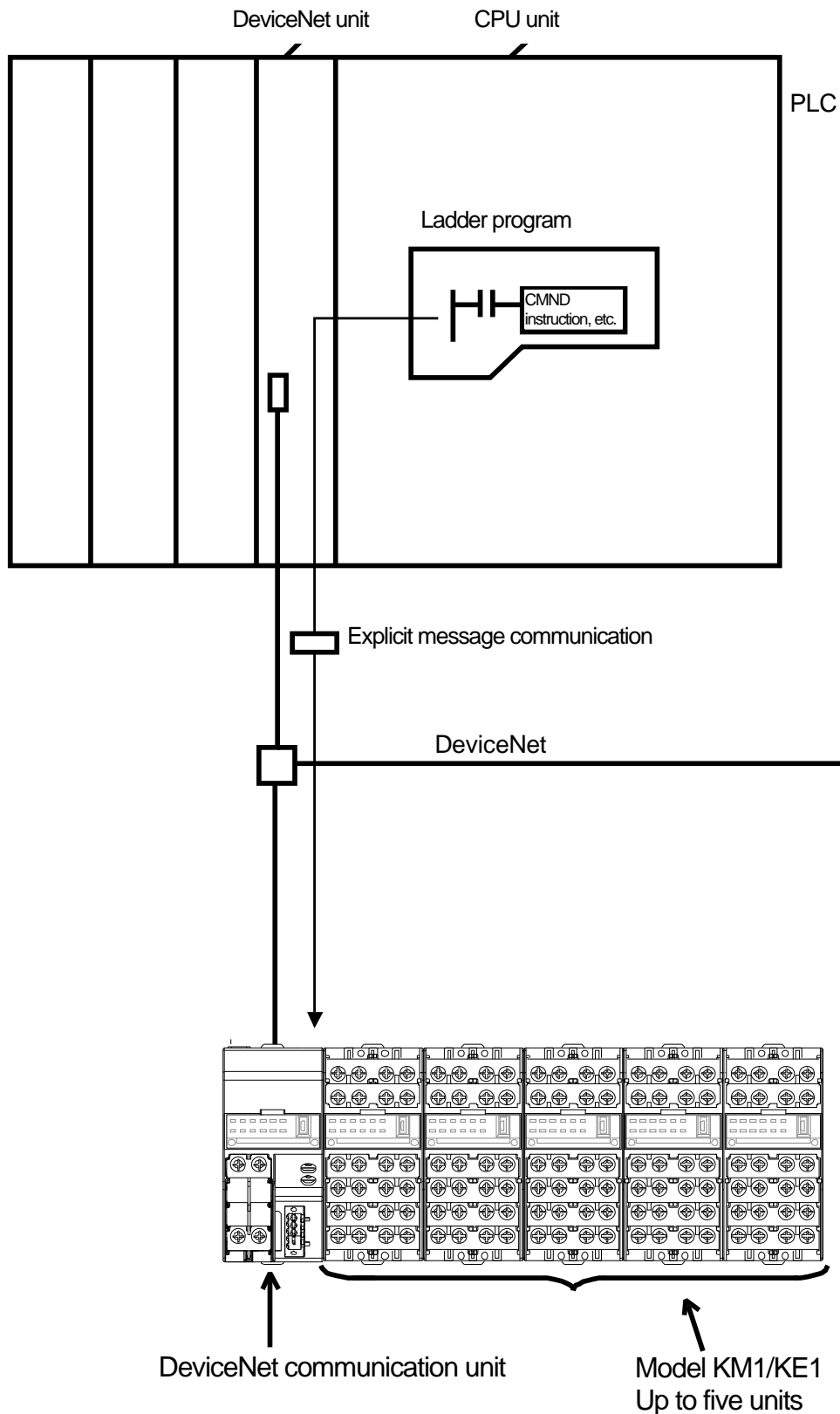

## ■ System Configuration

### ● Basic Configuration

The basic system configuration is the connection between the DeviceNet communication unit and high-order device (PLC, PC) as shown in the diagram below. The number of DeviceNet communication units that can be connected to a high-order device (PLC, PC) depends on the size of the memory area allocated by the high-order device. (Note 1)

As the DeviceNet communication unit cannot operate as an independent unit, it requires being connected to the measurement master of Model KM1/KE1 series. (Note 2)

- Functioning as DeviceNet slave, the DeviceNet communication unit can share I/O with a high-order device (PLC, PC) and send/receive data to/from the high-order device (PLC, PC) with Explicit message communication.

Note 1 One DeviceNet communication unit occupies the memory area of 32 channels at minimum. For example, if the size allocated by a high-order device (PLC, PC) is 64 channels, up to 2 DeviceNet communication units can be connected.

As the allocated size increases, the number of DeviceNet communication units that can be connected increases.

For information on the number of connections, refer to (pages 4-5 and 4-9).

Note 2 Up to five units (including one measurement master) of Model KM1/KE1 series can be connected to one DeviceNet communication unit.

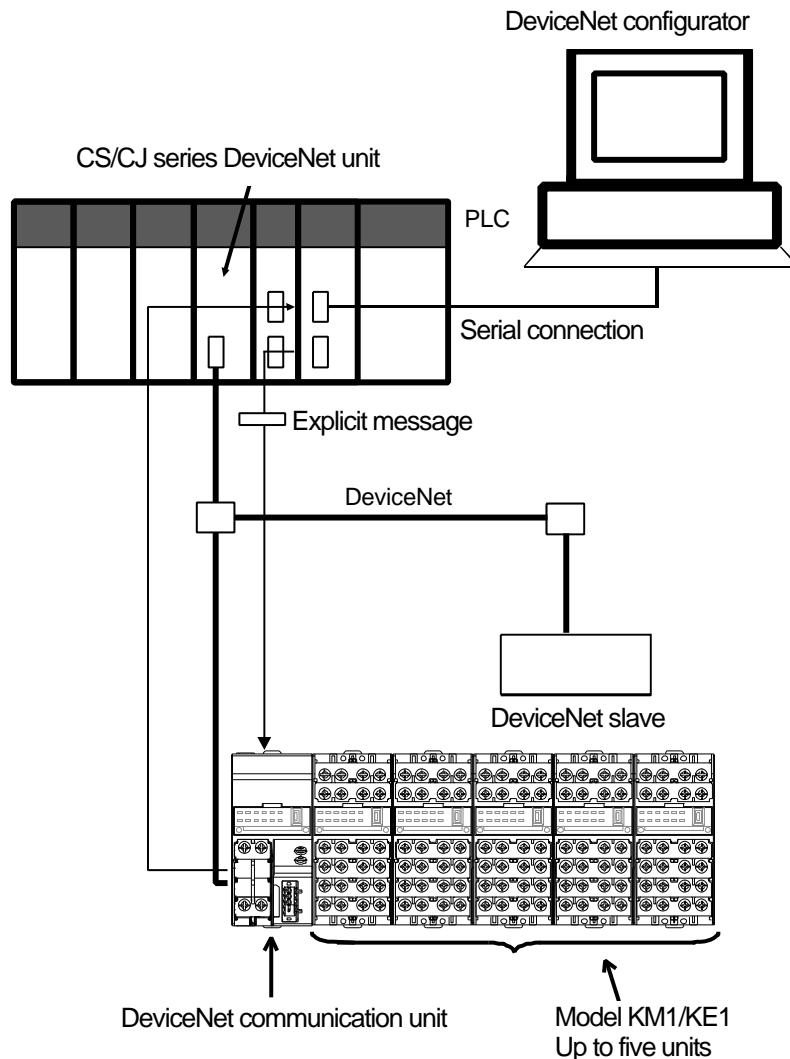

# 1.2 Specifications

## ■ DeviceNet Communication Specifications

Item		Specification			
Communication function	Remote I/O communication function	<ul style="list-style-type: none"> <li>· Master/Slave connection (Poll/Cyclic)</li> <li>· Conformance to DeviceNet communication protocol</li> </ul>			
	Selection of simple assignment	<ul style="list-style-type: none"> <li>· IN data assignment only with switch setting without configurator</li> <li>· Assignment of only basic data such as Model KM1/KE1 unit status and measurement data</li> <li>· IN area 1 block, 32 channels</li> <li>· OUT area 1 block, 1 channel</li> </ul>			
	Selection of I/O assignment with configurator	<ul style="list-style-type: none"> <li>· Assignment of intended IN and OUT data with configurator</li> <li>· Assignment of intended data such as parameters specific to DeviceNet communication unit and variable area of Model KM1/KE1 units</li> <li>· IN area 2 blocks, up to 61 channels *1</li> <li>· OUT area 1 block, 1 channel (Fixed to soft reset) *2</li> </ul>			
	Message communication function	<ul style="list-style-type: none"> <li>· Explicit message communication function</li> <li>· Issuing CompoWay/F communication command possible (Issuing explicit message communication format)</li> </ul>			
	Setting from configurator	<ul style="list-style-type: none"> <li>· Configuration of DeviceNet communication unit</li> <li>· Assignment of Model KM1/KE1 unit parameter to high-order device (PLC, PC)</li> <li>· Assignment of data to IN and OUT areas</li> </ul>			
Topology		Combination of multidrop and T-branch connections possible (For main and branch lines)			
Communication speed		500 k/250 k/125 k bps (Automatic detection)			
Communication media		5 dedicated cables (Signal system: 2, Power supply system: 2, Shield: 1)			
Communication distance	Communication speed	Max. network length	Branch line length	Total of branch lines	
	500 k bit/s	100 m or less (100 m or less)	6 m or less	39 m or less	
	250 k bit/s	250 m or less (100 m or less)	6 m or less	78 m or less	
	125 k bit/s	500 m or less (100 m or less)	6 m or less	156 m or less	
Value within the parentheses ( ) applied when a thin cable is used					
Power supply for communication		24 VDC supply from outside			
Max. number of connected nodes		3 (Including configurator when it is connected)			
Max. number of connected slaves		2			
Error control		CRC error			

- \*1. Using two blocks possible only when DeviceNet unit for CS/CJ series is used as high-order device (PLC, PC)  
 IN area 1: 32 channels, IN area 2: 29 channels when the DeviceNet master unit for CVM1/CV/SYSMAC  $\alpha$  series is used
- \*2. Only one channel per node is assigned to OUT area when the DeviceNet master unit for CVM1/CV/SYSMAC  $\alpha$  series is used.



## ■ Connection Specifications

Item	Specification
Max. number of connected units	5 units (Excluding DeviceNet communication unit)
Measurement master to be connected	<ul style="list-style-type: none"> <li>· Model KM1-PMU1A-FLK</li> <li>· Model KM1-PMU2A-FLK</li> <li>· Model KE1-PGR1C-FLK</li> <li>· Model KE1-PVS1C-FLK</li> </ul>
Slaves that can be connected to measurement master	<ul style="list-style-type: none"> <li>· Model KM1-EMU8A-FLK</li> <li>· Model KE1-VSU1B-FLK</li> <li>· Model KE1-VAU1B-FLK</li> <li>· Model KE1-CTD8E</li> <li>· Model KE1-ZCT8E</li> </ul>

## ■ General Specifications

Item	Specification
Rated power supply voltage	AC100~240V 50/60Hz
Allowable voltage range	85 to 110% of rated power supply voltage
Power consumption (under max. load)	10 VA or less
Current consumption (DeviceNet power supply)	45 mA or less (24 VDC)
Vibration resistance	10 to 55 Hz, 10 m/s <sup>2</sup> , in 3 axial directions, 2 h
Shock resistance	Half amplitude: 0.35 mm Acceleration: 50 m/s <sup>2</sup> Frequency of vibration: 10 to 55 Hz Sweep in 3 axial directions, 5 min each x 10 times
Withstand voltage	2000 V for 1 minute, Between all terminals and the case simultaneously Between all power sources and all of temperature input/RS-485/USB/DeviceNet/transistor output simultaneously
Insulation resistance	20 MΩ or more (with 500 VDC megger)
Ambient operating temperature	-10 to 55°C (No condensation nor freezing)
Ambient operating humidity	Relative humidity: 25 to 85%
Storage ambient temperature	-25 to 65°C (No condensation nor freezing)
Dimensions	45 (W) x 90 (H) x 110 (D) mm (Protrusion not included)
Memory protection	Number of times that EEPROM (non-volatile memory) is written to: 1 million times
Weight	About 170 g

# 1.3 Connection of Model KM1/KE1 Unit

## ■ Identification of Model KM1/KE1 Unit and Number of Connected Units

The DeviceNet communication unit is connected and installed as shown in the diagram below.

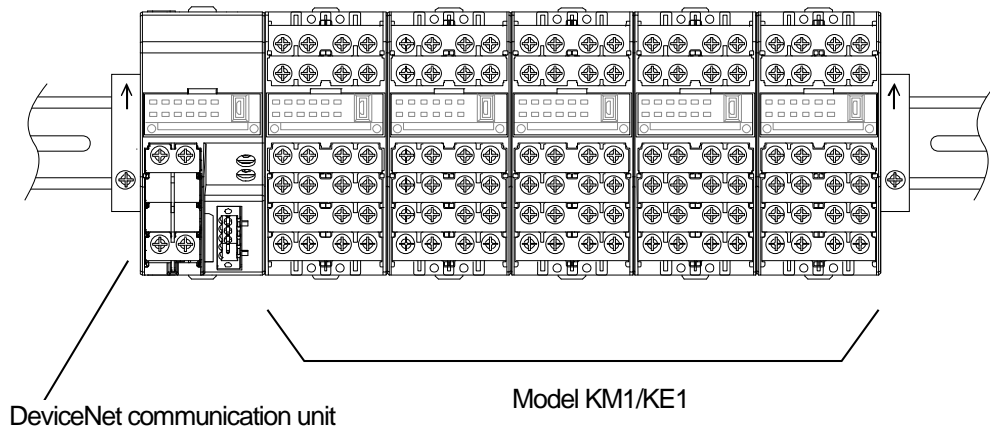

The DeviceNet communication unit identifies whether a connected Model KM1/KE1 unit is a measurement master or slave according to slave ID (0 to 5). (Identification is not affected by the connection order of units.)

To set the slave ID of a Model KM1/KE1 unit, use the rotary switch on top of the product. Be careful not to assign the same slave ID to multiple connected units.

- \* The DeviceNet communication unit cannot operate as an independent unit. The minimum configuration consists of a DeviceNet communication unit and a Model KM1/KE1 measurement master connected to each other.
- \* The maximum configuration consists of a DeviceNet communication unit and five units of Model KM1/KE1 series (six units in total).
- \* The slave ID of the DeviceNet communication unit is fixed to 6 and that of the measurement master to 0. (The DeviceNet communication unit and measurement master are not provided with a rotary switch.)

## ■ Types of Model KM1/KE1 Units

Model	Name	Abbreviation	Unit classification
Model KM1-PMU1A-FLK	Power measurement unit	PMU1A	Measurement master
Model KM1-PMU2A-FLK	Two power systems measurement unit	PMU2A	
Model KE1-PGR1C-FLK	Power/leakage monitor unit	PGR1C	
Model KE1-PVS1C-FLK	Power/voltage sag monitor unit	PVS1C	Functional slave
Model KM1-EMU8A-FLK	Pulse/temperature input unit	EMU8A	
Model KE1-VSU1B-FLK	Voltage sag monitor unit	VSU1B	
Model KE1-VAU1B-FLK	Voltage/current monitor unit	VAU1B	CT extension slave
Model KE1-CTD8E	CT extension unit	CTD8E (Note 1)	
Model KM1-CTD8E			
Model KE1-ZCT8E	ZCT extension unit	ZCT8E	

Note 1 Model KM1-CTD8E and Model KE1-CTD8E have the same specifications, but their model numbers are different. Accordingly, unless otherwise specified, CTD8E refers to both Model KM1-CTD8E and Model KE1-CTD8E.

# 1.4 Initial Settings of Model KM1/KE1 Units

## ■ Setting by Explicit message

A high-order device (PLC, PC) configures KM1/KE1 units through Explicit message communication.

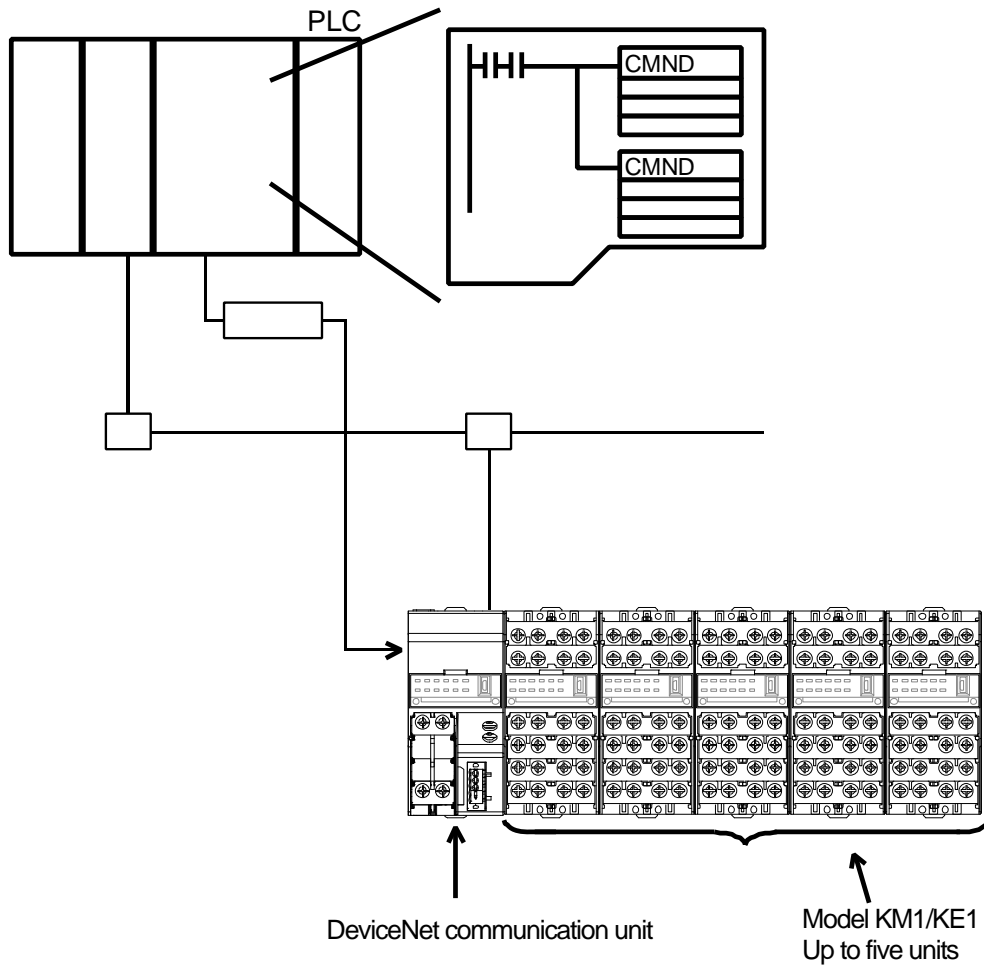





## Chapter 2 Instructions for Use

2.1	Setup Procedure .....	2-2
2.2	Procedure to Be Taken Before Operation .....	2-3
	■ Selection of Simple Assignment .....	2-3
	■ Selection of I/O Assignment with Configurator.....	2-4

## 2.1 Setup Procedure

Follow the steps described below to make the DeviceNet communication unit ready for use. For details on each step, refer to the corresponding reference page.

Step	Item	Description	Reference page
1	Setting of slave ID with configuration switch (Functional slave and communication slave only)	Set a slave ID with the configuration switch (rotary switch) on the top of a connected unit. Select a position from 1 to 5 of the setting range. Be careful not to set a duplicate slave ID.	Refer to related manuals.
2	Initialization with USB or RS-485	Connect the mini-USB type B to the USB port on the front side of the product to start initialization. Connect the cable to the RS-485 terminal of the product, and turn on the power to start initialization. Note: When initialization is completed, turn off the power.	-
	Unit No. setting	Set a unit No. The setting range is 00 to 99. Be careful not to set a duplicate unit No.	Refer to related manuals.
	Node address setting (Communication slave only)	Assign a DeviceNet node address (0 to 63) to a DeviceNet communication unit. Set a number in the ten's place with the rotary switch ( $\times 10^1$ ) and a number in the unit's place with the rotary switch ( $\times 10^0$ ). Be careful not to set a duplicate node address.	Page 3-5
	Setup of connection configuration (Measurement master only)	Set a connection configuration. For information on the setup procedure, refer to "Model KM1 User's Manual" (KANC-701), "KE1 User's Manual" (SGTE-717), and "Model KM1/KE1 Communication Manual" (SGTE-719).	Refer to related manuals.
3	Connection between DeviceNet communication unit and Model KM1/KE1 unit.	Connect a DeviceNet communication unit and a Model KM1/KE1 unit. Use the lateral connection hooks attached to the top and bottom of the units to connect them. Then connect the connection connectors.	Page 3-6
4	Attachment of connected units on DIN rail	Attach the connected units on the DIN rail. When attaching the units, be sure to attach the end plates to both ends to lock the units in place.	Page 3-8
5	Wiring	Connect wires to the terminals to be used. Note: At this point, do not turn on the power of peripherals. Install wires from the lower portion.	Page 2-2 Fig. 1

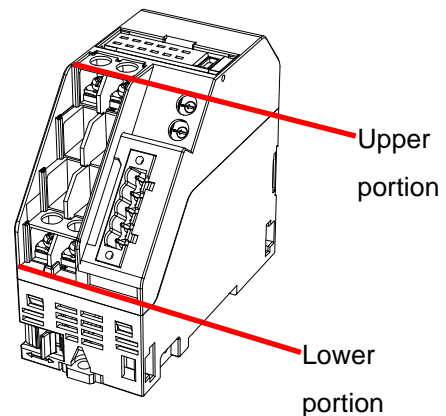

Fig. 1

## 2.2 Procedure to Be Taken Before Operation

### ■ Selection of Simple Assignment

This method is used in the following cases.

- When you wish to assign the measurement data and status of each KM1/KE1 unit to a high-order device (PLC, PC)
- When you wish to use DeviceNet communication units without using a configurator

Step	Item	Description	Reference page
6	Selection of simple assignment method (Note 1)	Turning off the 1st pin of the configuration switch on the top of the product allows the selection of simple assignment. (Factory default setting: 1st pin is off)	Page 3-5
7	Connection of DeviceNet communication connector	Connect the DeviceNet communication connector to the DeviceNet communication unit. Note: At this point, do not turn on the power for communications. The power is also used as the power of the internal circuit of the DeviceNet communication unit.	Page 3-12
8	Application of power supply voltage	Apply power supply voltage. Note: Model KM1/KE1 units are started.	-
9	Turning on of DeviceNet communication power (V+, V-)	Turn on the communication power supply connected to the DeviceNet communication unit. Note: The DeviceNet communication unit is started.	-
10	Check of LED of DeviceNet communication unit	Check that the LED of the DeviceNet communication unit is in the state as shown below. MS: Green lighting under normal condition NS: Green lighting under normal condition (DeviceNet online/communication connection completed)	Page 3-4

Note 1 Complete the configuration switch setting before attaching the main unit of the product to the equipment. The configuration switch is on the top of the unit. Setting the switch may not be easy due to insufficient space available after the unit is installed in the equipment.

## ■ Selection of I/O Assignment with Configurator

This method is used in any one of the following cases.

- When you wish to select desired KM1/KE1 unit(s) and status(es) and assign their corresponding measurement data and the status(es) to a high-order device (PLC, PC).
- When you wish to set a desired order in which data is assigned
- When you wish to assign only data necessary in remote I/O communication at all times to a high-order device (PLC, PC) and do not wish to assign unnecessary data

### Information

Up to 61 channels are available in the IN area for remote I/O communication and only 1 channel in the OUT area. If you wish to read and write data exceeding the limits, follow the instruction below.

- **Use Explicit message communication.**  
Use Explicit message communication for the data that you wish to read or write only when necessary.
- \* If data is assigned to 61 channels, using two DeviceNet communication units is impossible.

Step	Item	Description	Reference page
6	Selection of I/O assignment method (Note 1)	This allows a configurator to set the I/O of data assigned to the IN area used by a DeviceNet communication unit. Turn on the 1st pin of the configuration switch on the top of the product. (Factory default setting: 1st pin is off)	Page 3-6
7	Connection of DeviceNet communication connector	Connect the DeviceNet communication connector to the DeviceNet communication unit. Note: At this point, do not turn on the power for communications. The power is also used as the power of the internal circuit of the DeviceNet communication unit.	Page 3-12
8	Application of power supply voltage	Apply power supply voltage. Note: Model KM1/KE1 units are started.	-
9	Turning on of DeviceNet communication power (V+, V-)	Turn on the communication power supply connected to the DeviceNet communication unit. Note: The DeviceNet communication unit is started.	-
10	Check of LED of DeviceNet communication unit	Check that the LED of the DeviceNet communication unit is in the state as shown below. MS: Green lighting under normal condition NS: Green lighting under normal condition (DeviceNet online/communication connection completed)	Page 3-4
11	Operation from configurator	(1) In the Device Parameter Edit window of the DeviceNet communication unit, set the I/O assignment of the IN area as described below. a. Select desired assignment data from the options. b. Bring the unit online and download the data to the DeviceNet communication unit.  (2) If you divide the IN area used by the DeviceNet communication unit into two, select the DeviceNet communication unit in the Device Parameter Edit window of the high-order device (PLC, PC) and configure connections in the Detailed Settings. If the IN area is divided into two, the parameter of each measurement data is assigned to the IN area 1 and each status is assigned to the IN area 2. Then the IN area 1 can be set to DM and IN area 2 can be set to CIO.  (3) If the free assignment by the configurator is used, the IN and OUT areas used by the DeviceNet are assigned to a high-order device in the Device Parameter Edit window of the high-order device (PLC, PC). In the "Master I/O Assignment" tab, specify the first address of the assignment inputs 1 and 2 and assignment output 1 and download parameters to the high-order device (PLC, PC). Note: In simple assignment, automatic assignment is made.	Refer to Chapters 4 and 5
12	Start of remote I/O communication	Enable the scan list of the high-order device (PLC, PC) side and put the high-order device (PLC, PC) into the "Operation" mode. This causes remote I/O communication to be started and the contents of the IN and OUT areas on both high-order device (PLC, PC) and DeviceNet communication unit sides to be synchronized.	-
	Under Explicit message communication	Explicit messages are issued from the high-order device (PLC, PC) side. To perform the control and monitor operations unavailable only with the IN and OUT areas, Explicit messages are issued to the DeviceNet communication unit.	Page 6-2

Note 1 Complete the configuration switch setting before attaching the main unit of the product to the equipment. The configuration switch is on the top of the unit. Setting the switch may not be easy due to insufficient space available after the unit is installed in the equipment.

- \* If the communication speed of a high-order device (PLC, PC) is changed after the DeviceNet communication unit is started, restart the whole system.



# Chapter 3 Name of Each Part, Installation, and Wiring

3.1	Name and Function of Each Part.....	3-2
■	Name of Each Part.....	3-2
●	External dimensions (Unit: mm) .....	3-3
●	Layout of terminals.....	3-3
■	Display .....	3-4
●	LED indication under normal conditions.....	3-4
■	Switch Setting .....	3-5
●	Node address setting.....	3-5
●	Configuration switch.....	3-5
3.2	Installation .....	3-6
■	Attachment of DeviceNet Communication Unit and Model	
	KM1/KE1 Unit.....	3-6
●	Lateral connection hook.....	3-6
●	Connector.....	3-7
■	Attachment to DIN Rail.....	3-8
●	Retaining device.....	3-8
●	Removal method.....	3-9
3.3	Wiring of DeviceNet Cables .....	3-10
■	Preparation of DeviceNet Communication Cable.....	3-10
■	Connection to DeviceNet Communication Unit .....	3-12
3.4	Wiring for Model KM1/KE1 Units .....	3-13

# 3.1 Name and Function of Each Part

## ■ Name of Each Part

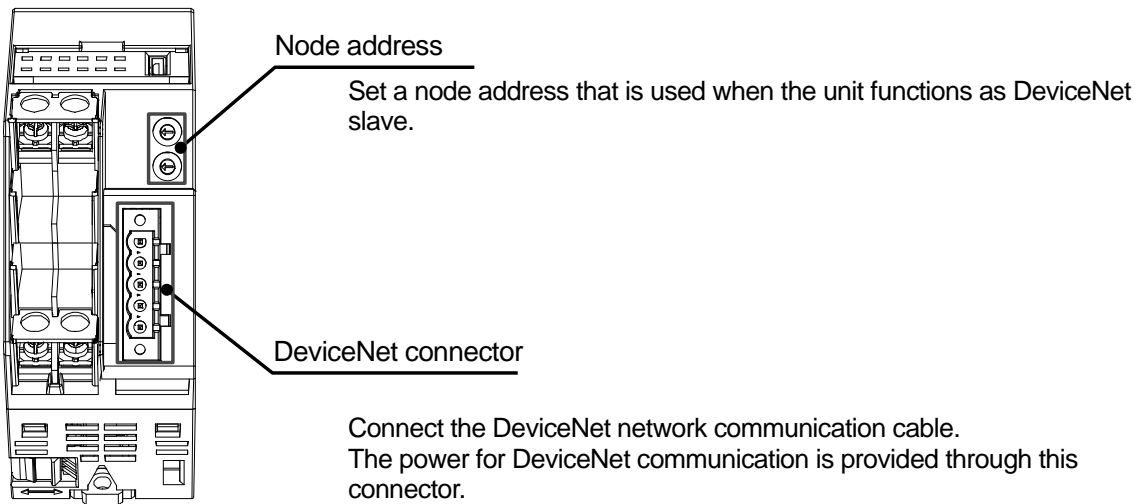
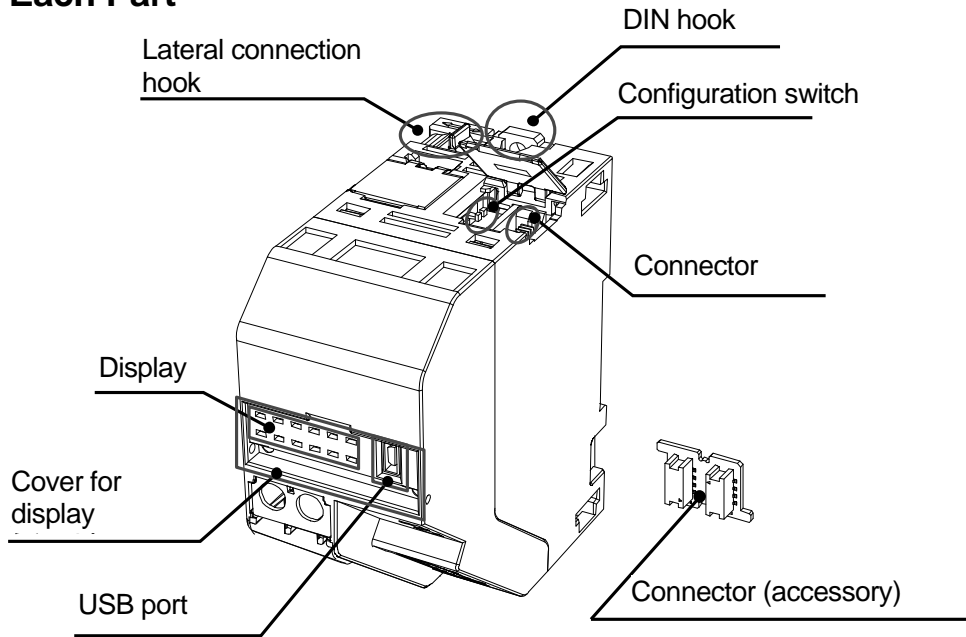

Connect the DeviceNet network communication cable.  
 The power for DeviceNet communication is provided through this connector.  
 Use FCK2.5/5-STF-5.08AU as the connector connected to this connector.

Name of Each Part, Installation, and Wiring

● External dimensions (Unit: mm)

45 (W) x 96 (H) x 90 (D) (Excluding protrusion)

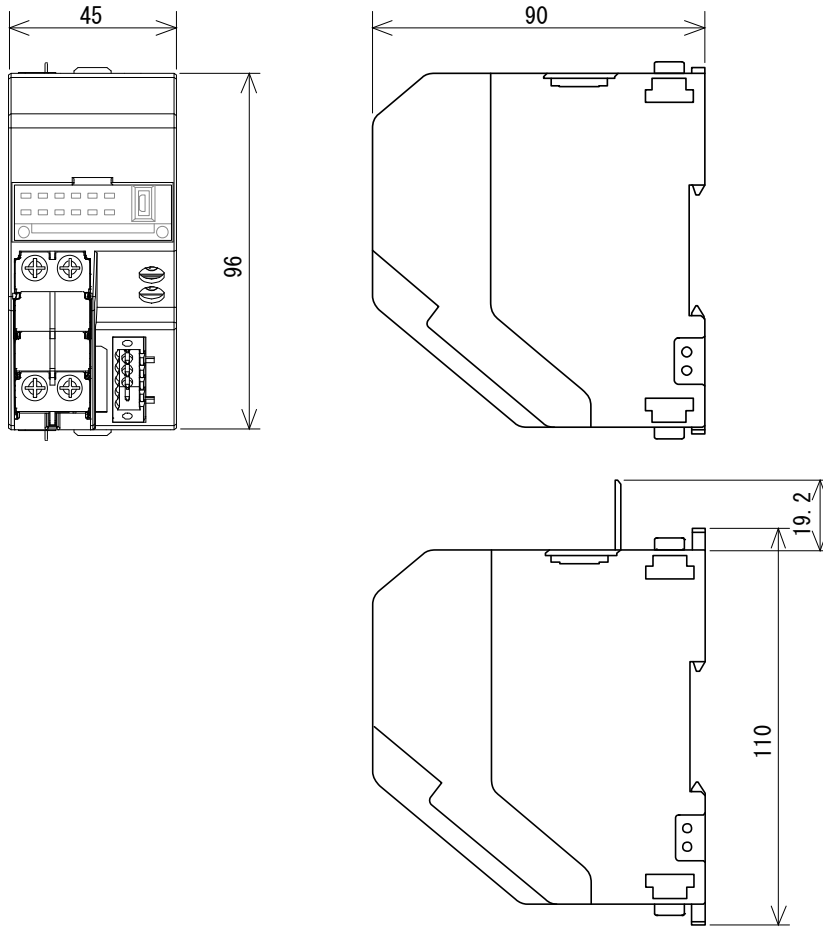

Name of Each Part, Installation, and Wiring

● Layout of terminals

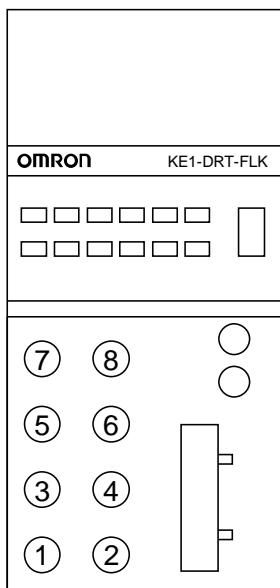

Terminal No.	Model KE1-DRT-FLK DeviceNet communication unit
(1)	Power supply voltage
(2)	Power supply voltage
(3)	NC
(4)	NC
(5)	NC
(6)	NC
(7)	RS-485 A(-)
(8)	RS-485 B(+)

## Display

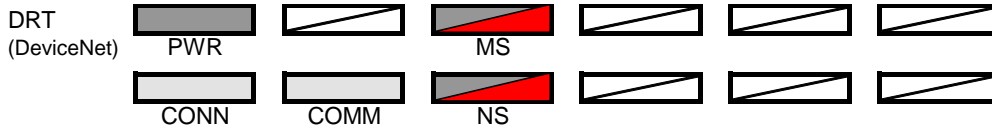

LED name	Name	Color	Status	Meaning (Major problem)
PWR	Power supply	Green		Power ON state
				Error state (*1)
				No power supply
CONN	Internal bus communication	Yellow		State where multiple units are connected
				State where multiple units are not connected
COMM	RS-485 or USB communication	Yellow		In RS-485 or USB communication
				No RS-485 nor USB communication
MS	Module status	Green		Normal state (DeviceNet communication unit under normal conditions)
				Not set (Under the selection of I/O assignment with configurator) · Connection configuration not set · I/O assignment not set
		Red		Fatal failure (*1) · Watchdog timer error · RAM error
				Slight failure (*2) · EEPROM checksum error · EEPROM hardware error
		-		No power supply · No power supply to DeviceNet communication unit · Resetting in progress · Waiting for the start of initialization
NS	Network status (DeviceNet)	Green		Online/communication connection completed (Network under normal state)
				Online/communication unconnected (Waiting for establishment of connection from high-order device)
		Red		Communication error (Detection by unit about error indicating unavailability of communication on the network) · Node address duplication · Busoff detection
				Slight communication error (*2) · Communication timeout
		-		Offline/power off state · Waiting for completion of checking node address duplication in high-order device · No power supply to DeviceNet communication unit

: Lighting    : Flashing    : Off

\*1 Repair is required. Contact the supplier of your product or our sales office.

\*2 After the power is turned off, if the problem remains, repair is required. Contact the supplier of your product or our sales office.

### LED indication under normal conditions

All of PWR, MS, and NS LEDs light up in green and CONN lights up in yellow.

## Switch Setting

### ● Node address setting

When the DeviceNet communication unit functions as a slave in the DeviceNet network, it requires a node address. Set the node address in decimal notation within the range of 00 to 63.

(The setting of 64 to 99 is unavailable.)

Set a number in the unit's place with the lower rotary switch ( $\times 10^0$ ) and a number in the ten's place with the upper rotary switch ( $\times 10^1$ ). As long as the node address of the DeviceNet communication unit is not same as the one of another node (master, slave and configurator) in the same network, desired node address can be set within the specified range.

NODE ADDRESS

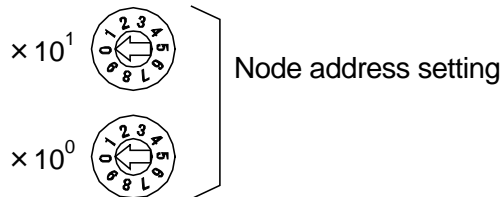

**Note:** Before this setting, be sure to turn off the power of DeviceNet.

**Information**

- The factory default setting is 00.
- If the set node address is same as the one of another node, node address duplication occurs and joining the communication network is impossible.

### ● Configuration switch

The configuration switch allows the selection of simple assignment and a communication protocol.

DIP switch	1st pin	:	OFF	Simple assignment
		:	ON	Manual assignment
	2nd pin	:	OFF	CompoWay/F
		:	ON	Modbus

The diagram shows a DIP switch with two pins. The first pin is labeled '0' and the second pin is labeled '1'. The switch is shown in its OFF position.

- Selection of simple assignment  
Putting the 1st pin of the DIP switch into the OFF position allows simple assignment to be selected. This setting takes effect when the power is turned on. Any change made under energized conditions does not take effect. To change the setting, turn off the power first. Then make a change and turn on the power again.

\* When changing the setting of the configuration switch, move each pin into place with a small flat-head screwdriver.

**Note:** Complete all settings including the setting of the configuration switch before installing the product.

After installation, if the setting of the configuration switch needs to be changed, make sure that the power of the main unit is turned off. Then remove the unit and change the setting and install the unit again.

**Information**

- The factory default setting is OFF (simple assignment).

## 3.2 Installation

Connect Model KM1/KE1 units to the DeviceNet communication unit.

Up to five units of Model KM1/KE1 can be connected to one DeviceNet communication unit.

**Note:**

When the DeviceNet network connection is being established, do not attach/remove the communication cable to/from the DeviceNet communication unit. This may not allow normal communication due to a short circuit and contact failure in cables and a change of the terminator position due to the change of node configuration.

Be careful not to get an electric shock during the attachment/removal of DeviceNet communication units and wiring work. Take safety measures such as turning off the power of peripherals as necessary.

### ■ Attachment of DeviceNet Communication Unit and Model KM1/KE1 Unit

Connect adjacent units with the lateral connection hooks and supplied connectors.

#### ● Lateral connection hook

This hook is used to securely connect units on the DIN rail.

##### · Installation method

Slide the white hooks on the top and bottom of the unit until you hear a click to lock the unit in place.

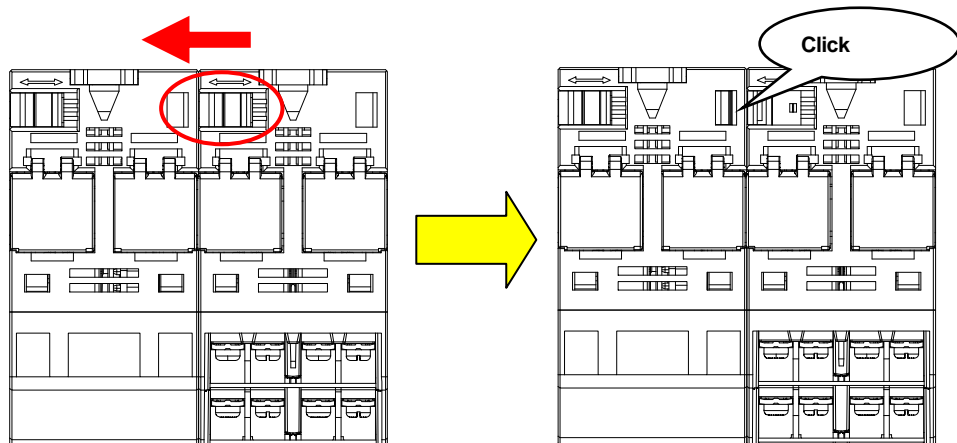

##### · Removal method

Pushing the encircled protrusion, slide the unit in the direction opposite to the one in which you slide at the time of installation.

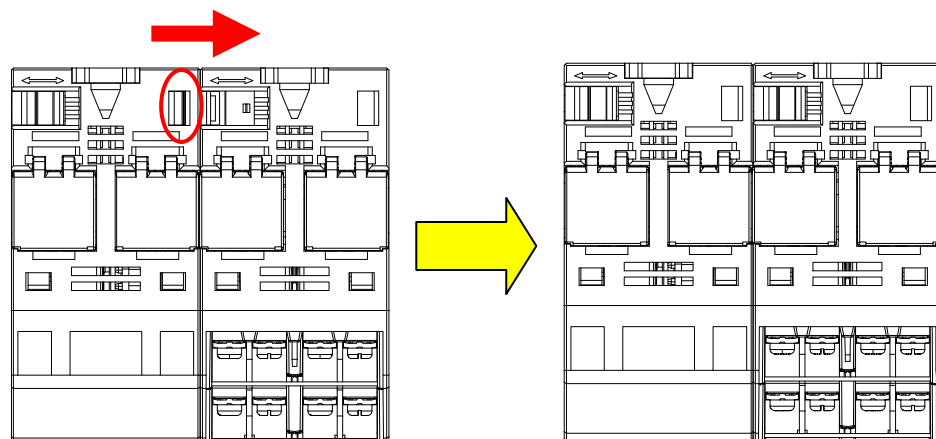

## ● Connector

This connector is used to connect units.

This allows the communications between units, which enhances the functionality.

### · Installation method

Open the cover on the top of the product and attach the supplied connector. Close the cover.

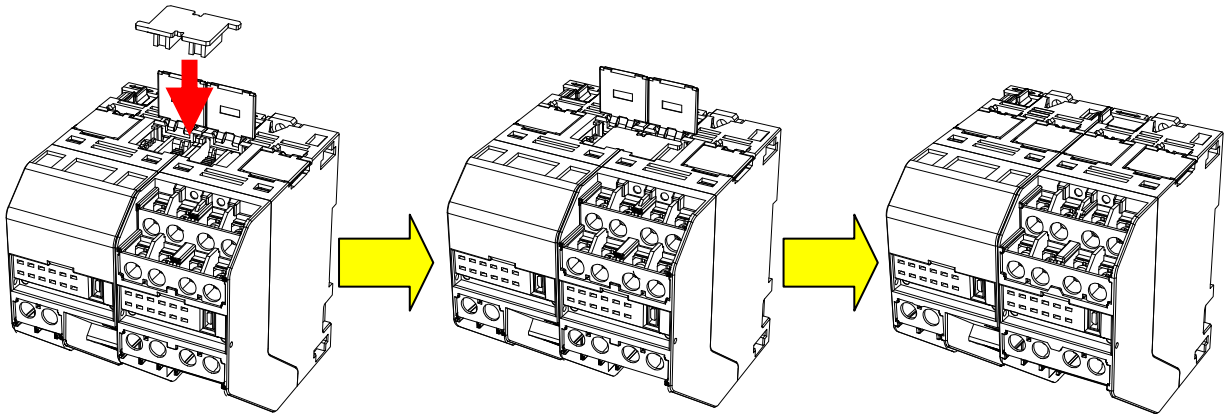

Name of Each  
Part, Installation,  
and Wiring

### · Removal method

Open the cover on the top of the product. As shown in the diagram below, fit a flat-head screwdriver into the red encircled portion of the supplied connector and remove the connector.

\* Be careful not to allow the flat-head screwdriver to come into contact with the internal PCB board.

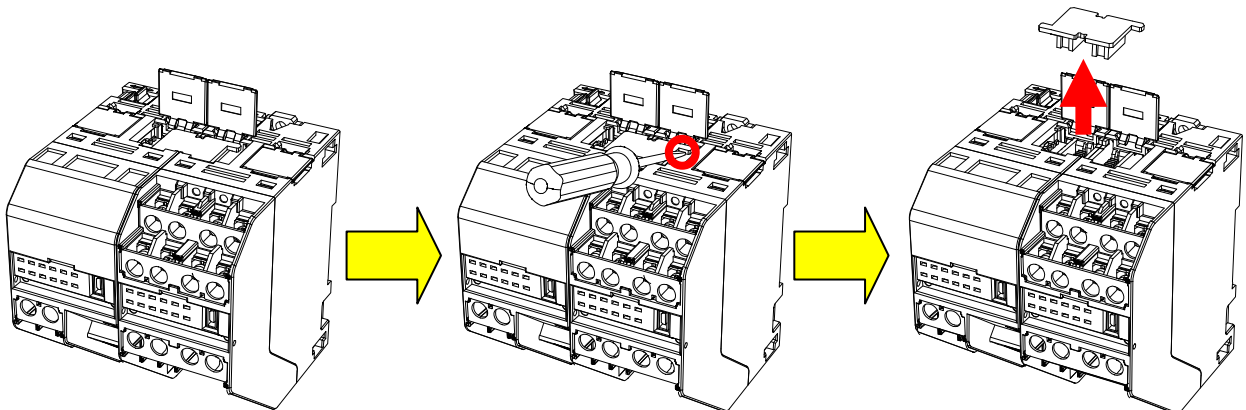

\*1 When using multiple units within system, be sure to lock the units in place with the lateral connection hooks and install the connectors.

## ■ Attachment to DIN Rail

### ● Retaining device

Attach DeviceNet communication units and Model KM1/KE1 units to the DIN rail. Screw the DIN rail into the control panel at three places or more.

- DIN rail: Model PFP-50N (50 cm)/Model PFP-100N (100 cm)

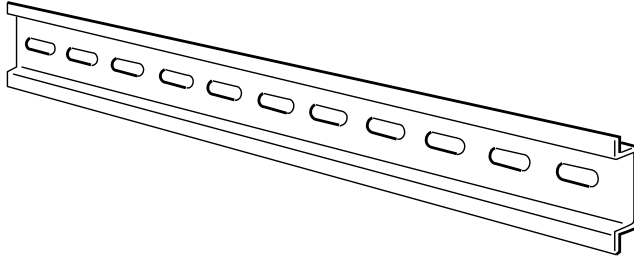

- End plate: Model PFP-M (two pieces)

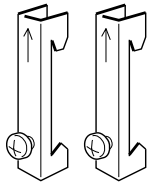

- Installation direction

The orientation in which units are installed in the DIN rail is determined. As shown below, place the DIN rail on the surface that is vertical to the ground.

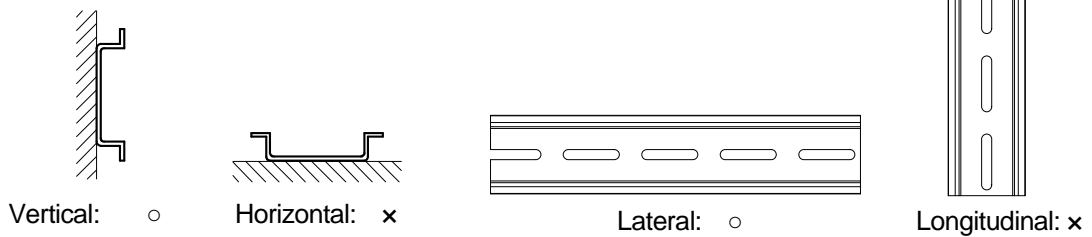



### Installation method

Lower the hook. Have the upper bent portion caught on the rail and push the unit it reaches the location where you can lock the hook. Then raise the hook and lock the unit in place.

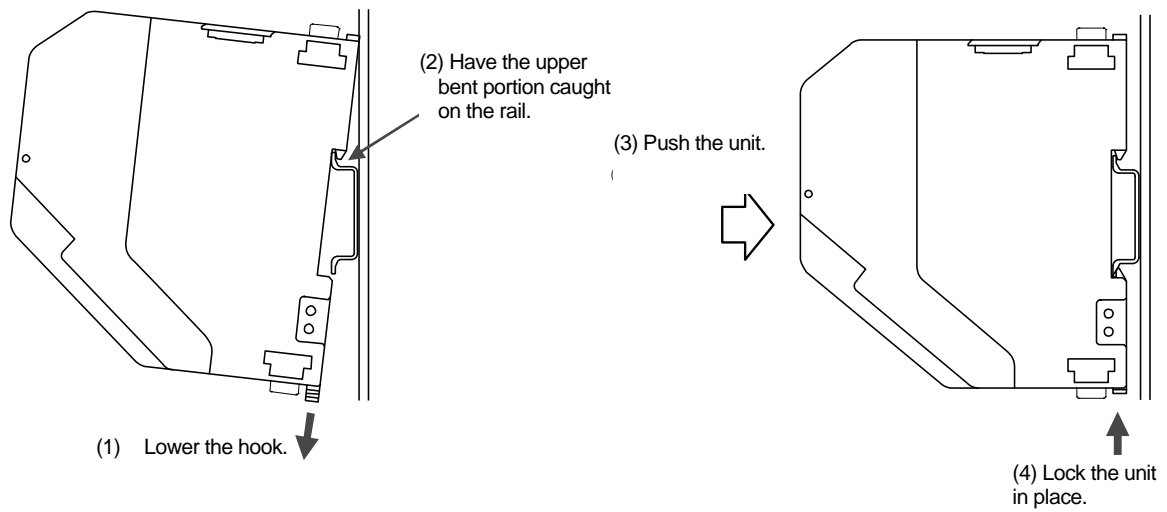

### Removal method

Pull the hook out with a flat-head screwdriver and then raise the unit from the bottom.

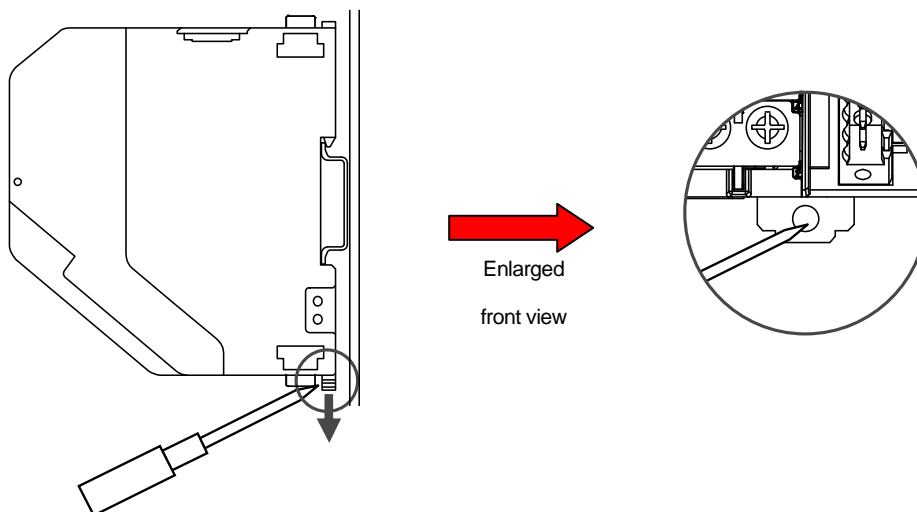

## 3.3 Wiring of DeviceNet Cables

The following describes how to process the DeviceNet communication cables connected to the DeviceNet communication units and how to install the communication connectors.

For information on the DeviceNet network such as the method of supplying power for DeviceNet communication and the method of grounding the DeviceNet network, refer to "DeviceNet User's Manual" (SCCC-308).

### ■ Preparation of DeviceNet Communication Cable

Following the procedure described below, prepare the communication cable and attach the connector.

- (1) While being careful not to severely damage the nets of the shield, strip the sheathing of the cable by 30 to 80 mm. Be careful not to strip the sheathing excessively because that may cause a short circuit.

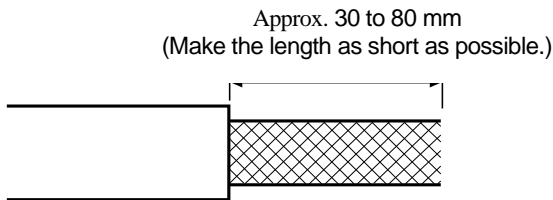

- (2) Loosen the shield net carefully. In addition to the signal and power lines, there is an unshielded shield wire. (You can tell the wire from the net by touching it as it is harder than the net.)

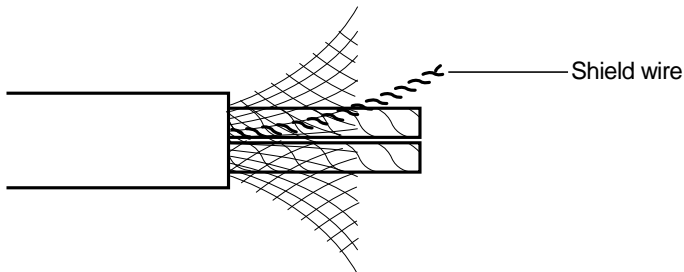

- (3) Remove the unnecessary part of the net and remove the aluminum tape wrapping the signal and power lines. Strip the sheathing of the lines by the amount necessary for the crimp-on terminals. Twist well the unshielded wires of the individual signal and power lines.

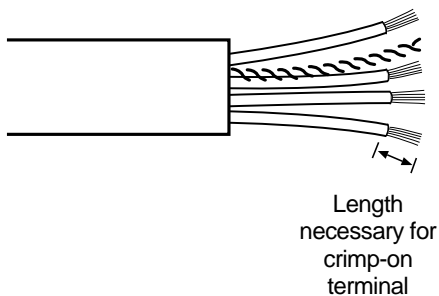

- (4) Insert the unsheathed portion of the wires into a crimp-on terminal and compress the terminal. Finish the lines with vinyl tape and heat shrink tubing. Paying attention to the orientation of the connector, insert the signal and power lines and shield wire into their corresponding connector holes. As shown in the diagram, insert them into the holes in the order of black, blue, shield, white, and red from the top.

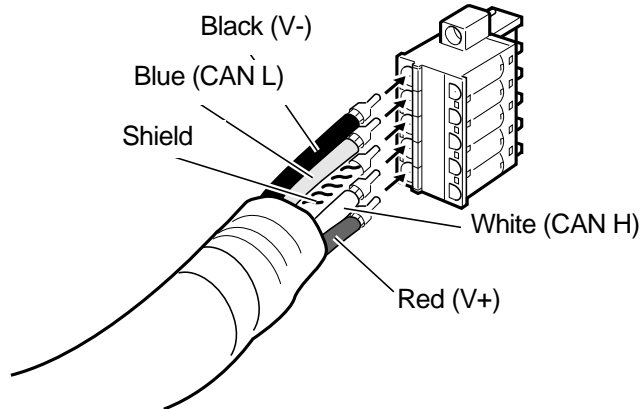

Both PLC and DeviceNet communication unit have labels corresponding to the cable colors. To make sure that the wiring is correct, check that the colors of the cables match the colors of the labels of the unit.

The colors of the cables are as shown below.

Color	Type of signal
Red	Power supply cable + side (V+)
White	Communication data high side (CAN H)
-	Shield
Blue	Communication data low side (CAN L)
Black	Power supply cable - side (V-)

- As the crimp-on terminals, the following products are recommended.  
AI series AI-0.5-8WH-B (Product No. 3201369) manufactured by Phoenix Contact

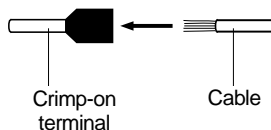

Insert the end of the cable into the crimp-on terminal and compress the terminal.

The following special tool is available as product.  
Model ZA3 manufactured by Phoenix Contact

- \* As the DeviceNet power supply, be sure to use the one with reinforced insulation or double insulation certified by the EN/IEC standards.

## ■ Connection to DeviceNet Communication Unit

Match the orientations of the connectors of the DeviceNet communication unit and the cable.  
 Push the cable connector into the connector of the DeviceNet communication unit until the protrusion of the cable connector completely fits into the connector.  
 Be sure to secure the connector with a screw. The appropriate tightening torque is 0.25 to 0.30 N·m.

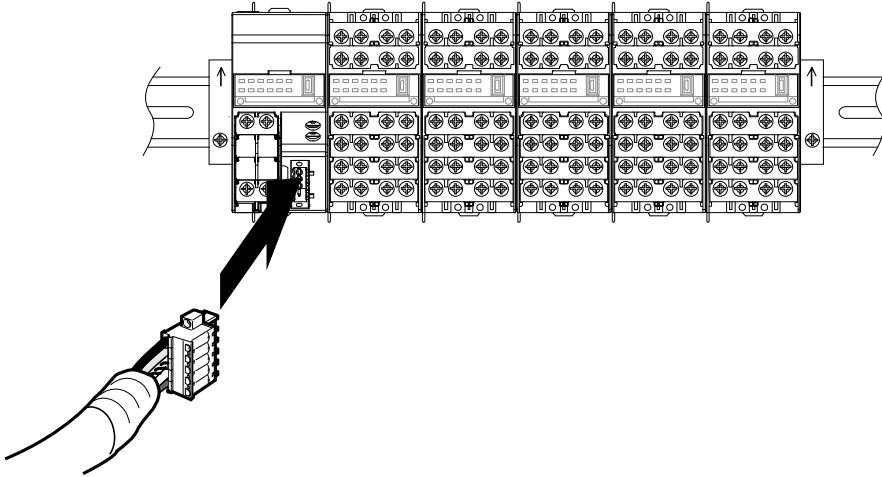

Name of Each Part, Installation, and Wiring

### Additional information

- When inserting thin cables into the connector supplied with the DeviceNet communication unit for multidrop connection or into the thin cables with multidrop connection (for thin cables) it is possible to insert two cables of the same color into a hole as shown in the figure below.

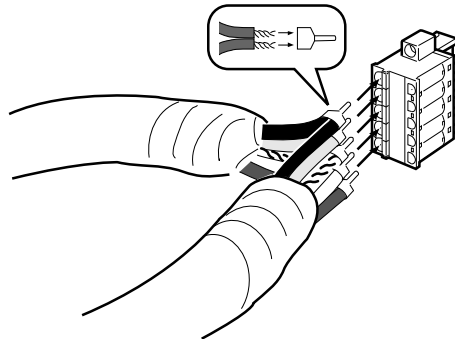

The two cables to be inserted into the same hole must be pushed into the same dedicated crimp-on terminal as shown in the diagram below.

For insertion of two cables

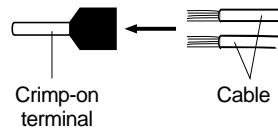

The following crimp-on terminal and crimping tool are recommended.

Crimp-on terminal	Crimping tool
Manufactured by Phoenix Contact	Manufactured by Phoenix Contact
Type: AI-TWIN2 x 0.5-8WH (Product No. 3200933)	Type: UD6 (Product No. 1204436)

## 3.4 Wiring for Model KM1/KE1 Units

For information on the wiring procedure for Model KM1/KE1 units, refer to "Model KM1 User's Manual" (KANC-701) and "Model KE1 User's Manual" (SGTE-717).



# Chapter 4 Remote I/O function

4.1	Overview of Assignment Method.....	4-2
■	Overview .....	4-2
■	Assignment Procedure .....	4-3
●	Configuration of slaves .....	4-3
●	Procedure .....	4-3
4.2	Simple Assignment .....	4-4
■	Setting of Assignment Data .....	4-5
●	Assignment range .....	4-5
■	Area Configuration for Simple Assignment .....	4-6
●	ch0, ch1 .....	4-6
●	ch 2 to ch 17 [Measurement master] (Slave ID: 0) .....	4-6
●	ch 18 to ch 31 [Functional slave, CT extension slave] (Slave ID: 1) .....	4-7
4.3	I/O Assignment with Configurator .....	4-8
■	Setting of Assignment Data .....	4-8
●	Creation of assignment data .....	4-8
●	Assignment range .....	4-9
●	DeviceNet configurator (Ver. 2.44 or later) .....	4-10
●	Screen description (DeviceNet Parameter Edit window) .....	4-11
■	List of Assignment Options .....	4-12
●	Status (ch0, ch1) .....	4-12
●	Measurement parameter (ch2 to ch60) .....	4-13
4.4	Assignment of Assignment Data to High-Order Device .....	4-14
■	Assignment to High-Order Device .....	4-14
●	Predetermined assignment .....	4-14
●	Desired assignment .....	4-14
■	Setting by DeviceNet Configurator .....	4-14
■	Connection Setting for Dividing IN Area into Two .....	4-17

## 4.1 Overview of Assignment Method

Using the DeviceNet communication unit allows the following parameters of Model KM1/KE1 units to be assigned to the I/O memory area of a high-order device (PLC, PC).

- Status
- Measurement parameter

### ■ Overview

The following describes the overview of the method of assigning parameters for the remote I/O communication used by a high-order device (PLC, PC) via the DeviceNet communication unit.

The DeviceNet communication unit allows specifying that "which data" of the Model KM1/KE1 and DeviceNet communication units is assigned to "where."

Data are automatically exchanged between a high-order device (PLC, PC) and the DeviceNet communication unit. This allows you to control and monitor Model KM1/KE1 units from the high-order device (PLC, PC) without being conscious of communications.

The DeviceNet communication unit allows parameters to be assigned to a high-order device (PLC, PC) in the following two ways.

#### (1) Simple assignment

Simple assignment allows the predetermined data such as status and measurement parameters to be automatically assigned.

- \* To enable simple assignment, set the 1st pin of the configuration switch to OFF.
- \* For details on simple assignment, refer to chapter 4.2.

#### (2) I/O assignment with configurator

From the list of options, you can select desired status and measurement data of the Model KM1/KE1 and DeviceNet communication units for ch0 to ch61. You can assign the selected data to any position within the I/O area of a high-order device.

Use the configurator to edit data to be assigned and to assign them to the I/O area of the high-order device.

- \* To enable the manual assignment with the configurator, set the 1st pin of the configuration switch to ON.
- \* For details on the manual assignment with the configurator, refer to chapter 4.3.



## ■ Assignment Procedure

Enable the remote communication between the high-order device (PLC, PC) and DeviceNet communication unit.

### ● Configuration of slaves

Define the data of the Model KM1/KE1 or DeviceNet communication unit that are assigned to the high-order device (PLC, PC) in the DeviceNet communication unit. Use the following (1) or (2) method for the assignment.

Method of setting assignment data	DIP switch 1	Description	Usage (example)
(1) Selection of simple assignment	OFF	Predetermined parameters are automatically set.	When you wish to assign only basic data such as statuses and measurement parameters of each Model KM1/KE1 unit to the high-order device (PLC, PC)
(2) Selection of I/O assignment with configurator	ON	The configurator allows selecting desired data to be assigned to the high-order device (PLC, PC) from the list of assignment options and setting assignment data.	<ul style="list-style-type: none"> <li>· When you wish to assign parameter and status data other than basic ones such as statuses and measurement parameters of each Model KM1/KE1 unit to the high-order device (PLC, PC)</li> <li>· When you wish to specify desired order in which data are assigned</li> <li>· When you wish to assign only data always necessary for remote I/O communication and do not wish to assign unnecessary data to the high-order device (PLC, PC)</li> <li>· When you wish to assign data to each of divided IN area (*1)</li> </ul>

\*1. When using the DeviceNet unit for CS/CJ series, IN area can be divided into two parts (IN area 1, IN area 2). You can assign desired data of options to each area. In this case, however, set two connections between the high-order device (PLC, PC) and DeviceNet communication unit in User Definition of Device Parameter Edit of the high-order device. For details, refer to "■ Connection Setting for Dividing IN Area into Two."

\*2. The number of blocks for assignment data is as follows.

Setting method	Number of blocks for assignment data
(1) Selection of simple assignment	IN area : 1 block OUT area : 1 or 2 blocks
(2) Selection of I/O assignment with configurator	IN area : 1 or 2 blocks OUT area : 1 block

### ● Procedure

Step	Selection of simple assignment	Selection of I/O assignment with configurator	Reference
Selection of assignment method	Set the DIP switch 1 to OFF.	Set the DIP switch 1 to ON.	Page 3-5
Setting of assignment data	Automatically assign predetermined assignment data.	Define assignment data in the Device Parameter Edit screen of the DeviceNet communication unit.	Page 4-4 Page 4-8
Assignment of assignment data to high-order device	Assign predetermined or desired data to the high-order device.		Page 4-14
Setting of block(s) to which data can be assigned	-	IN area : 1 block OUT area : 1 block	Page 4-16
Assignment of data to each block	-	-	Page 4-16
		Set connections in User Definition of the Device Parameter Edit screen of the high-order device (master unit) with the configurator.	

## 4.2 Simple Assignment

Simple assignment allows automatically assigning the data used in the I/O communication between the DeviceNet communication unit and a high-order device (PLC, PC) to the predetermined statuses or measurement parameters.

This method is used when you wish to assign only basic data, such as statuses and measurement parameters of Model KM1/KE1 units, to a high-order device (PLC, PC) without using a configurator.

To enable simple assignment, set the 1st pin of the configuration switch provided on the top of the unit to OFF.

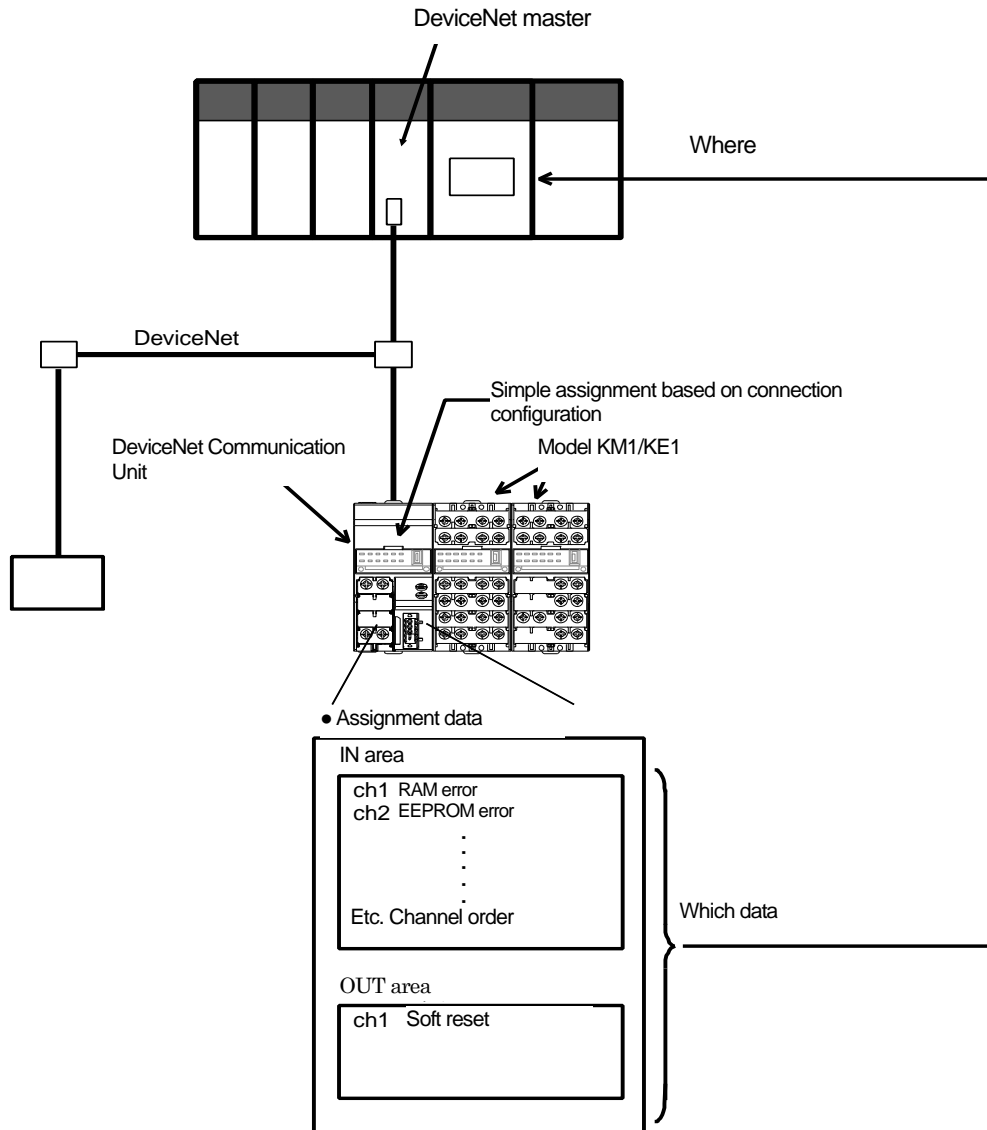

\* Simple assignment of the data described above is based on the connection configuration.

## ■ Setting of Assignment Data

In simple assignment, predetermined data is assigned during remote I/O communication.

For information on the list of data for simple assignment, refer to "■ Area Configuration for Simple Assignment" (page 4-6).

### ● Assignment range

The range of simple assignment is as shown below.

- IN area : 32ch
- OUT area : 1ch

\* The number of DeviceNet communication units that can be connected to a high-order device (PLC, PC) is restricted. When using the simple assignment method to assign data for remote I/O communication, refer to the example below.

Example: Maximum number of units that can be connected to a high-order device (PLC, PC) (In the case of CS1/CJ1 series manufactured by Omron)

The DeviceNet communication unit occupies 32 channels in the IN area in simple assignment. If 64 channels are the assignment size provided by the high-order device (PLC, PC), up to two DeviceNet communication units can be connected.

	Max. assignment size per high-order device (PLC, PC)	
DeviceNet communication unit	32 channels	32 channels
High-order device (PLC, PC) (CS1/CJ1 series)	64 channels (In the case of predetermined data assignment) Note 1	500 channels x 2 blocks (In the case of desired data assignment) Note 1
Max. number of connected DeviceNet communication units	2 units	31 units

Note 1 Predetermined and desired data assignments are the methods of assigning data of the DeviceNet communication unit to a high-order device (PLC, PC). For details, refer to "4.4 Assignment of Data to High-Order Device."

## Area Configuration for Simple Assignment

The following shows the configuration of the IN area for simple assignment.

### ● ch0、ch1

ch	bit	Applicable unit	IN area
0	0	All units (Slave IDs 0 to 6)	RAM error (E-M1)
	1		EEPROM error (E-M2)
	2		EEPROM error (E-M3)
	3		RTC error (E-T1)
	4		Communication error
	5		Operation mode
	6		Voltage input limit exceeded (E-S1)
	7		Current input limit exceeded (E-S2)
	8	Measurement master (Slave ID 0)	Input 1
	9		Input 2
	A		Input 3
	B		Input 4
	C		OUT1
	D		OUT2
	E		OUT3
	F		Alarm 1
1	0		Alarm 2
	1		Low state 1
	2		Middle state 1
	3		High state 1
	4	Functional slave, CT extension slave (Slave ID 1)	Input 1
	5		Input 2
	6		Input 3
	7		Input 4
	8		Input 5
	9		Input 6
	A		Input 7
	B		Input 8
	C		OUT1
	D		OUT2
	E		Alarm 1
	F		Alarm 2

### ● ch 2 to ch 17 [Measurement master] (Slave ID: 0)

ch	IN area PMU1A (Electric power)	IN area PMU2A (Electric power two systems)	IN area PGR1C (Electric power/leakage)	IN area PVS1C (Electric power/voltage sag)
2	Active power 1	Active power 1	Active power 1	Active power 1
3	Active power 2	Active power 2	Active power 2	Active power 2
4	Active power 3	Active power 5	Active power 3	Active power 3
5	Power factor 1	Active power 6	Power factor 1	Power factor 1
6	Power factor 2	Power factor 1	Power factor 2	Power factor 2
7	Power factor 3	Power factor 2	Power factor 3	Power factor 3
8	Voltage 1	Power factor 5	Voltage 1	Voltage 1
9	Voltage 2	Power factor 6	Voltage 2	Voltage 2
10	Voltage 3	Voltage 1	Voltage 3	Voltage 3
11	Current 1	Voltage 3	Current 1	Current 1
12	Current 2	Voltage 4	Current 2	Current 2
13	Current 3	Voltage 6	Current 3	Current 3
14	Frequency 1	Current 1	Frequency 1	Frequency 1
15	Vacant	Current 3	Leakage current 1	Vacant
16	Vacant	Current 7	Vacant	Vacant
17	Vacant	Current 9	Vacant	Vacant

● ch 18 to ch 31 [Functional slave, CT extension slave] (Slave ID: 1)

ch	IN area EMU8A (Pulse/temperature)	IN area VSU1B (Voltage sag)	IN area VAU1B (Voltage/current)	IN area CTD8E (CT expansion)	IN area ZCT extension (ZCT extension)
18	Temperature 1	Voltage 1	Current 1	Active power 1	Leakage current 1
19	Vacant	Voltage 2	Current 2	Active power 2	Leakage current 2
20	Vacant	Voltage 3	Current 3	Active power 3	Leakage current 3
21	Vacant	Voltage 4	Voltage 1	Active power 4	Leakage current 4
22	Vacant	Voltage 5	Voltage 2	Active power 5	Leakage current 5
23	Vacant	Voltage 6	Voltage 3	Active power 6	Leakage current 6
24	Vacant	Frequency 1	Voltage 4	Active power 7	Leakage current 7
25	Vacant	Vacant	Voltage 5	Active power 8	Leakage current 8
26	Vacant	Vacant	Voltage 6	Vacant	Vacant
27	Vacant	Vacant	Frequency 1	Vacant	Vacant
28	Vacant	Vacant	Vacant	Vacant	Vacant
29	Vacant	Vacant	Vacant	Vacant	Vacant
30	Vacant	Vacant	Vacant	Vacant	Vacant
31	Vacant	Vacant	Vacant	Vacant	Vacant

For details on each assignment data, refer to "Model KM1/KE1 Communication Manual" (SGTE-719).

**Information**

- Simple assignment does not allow changing the items of data to be assigned and the order in which they are assigned. If you wish to add/change an item of data or specify the order in which data are assigned, use the method of I/O assignment with configurator.

**Information**

- If multiple units are connected, the data of slave ID 0 and slave ID 1 are automatically assigned on the basis of the information of the connection configuration. Simple assignment is not applied to the data of slave ID 2 to slave ID 6 units except for a part of status errors.

## 4.3 I/O Assignment with Configurator

I/O assignment with configurator allows selecting necessary data only from the data sent from the DeviceNet communication unit during remote I/O communication to assign them to the memory area of the high-order device (PLC, PC). The I/O assignment also allows assigning data not handled in simple assignment.

To enable I/O assignment with configurator, set the 1st pin of the configuration switch provided on the top of the unit to ON.

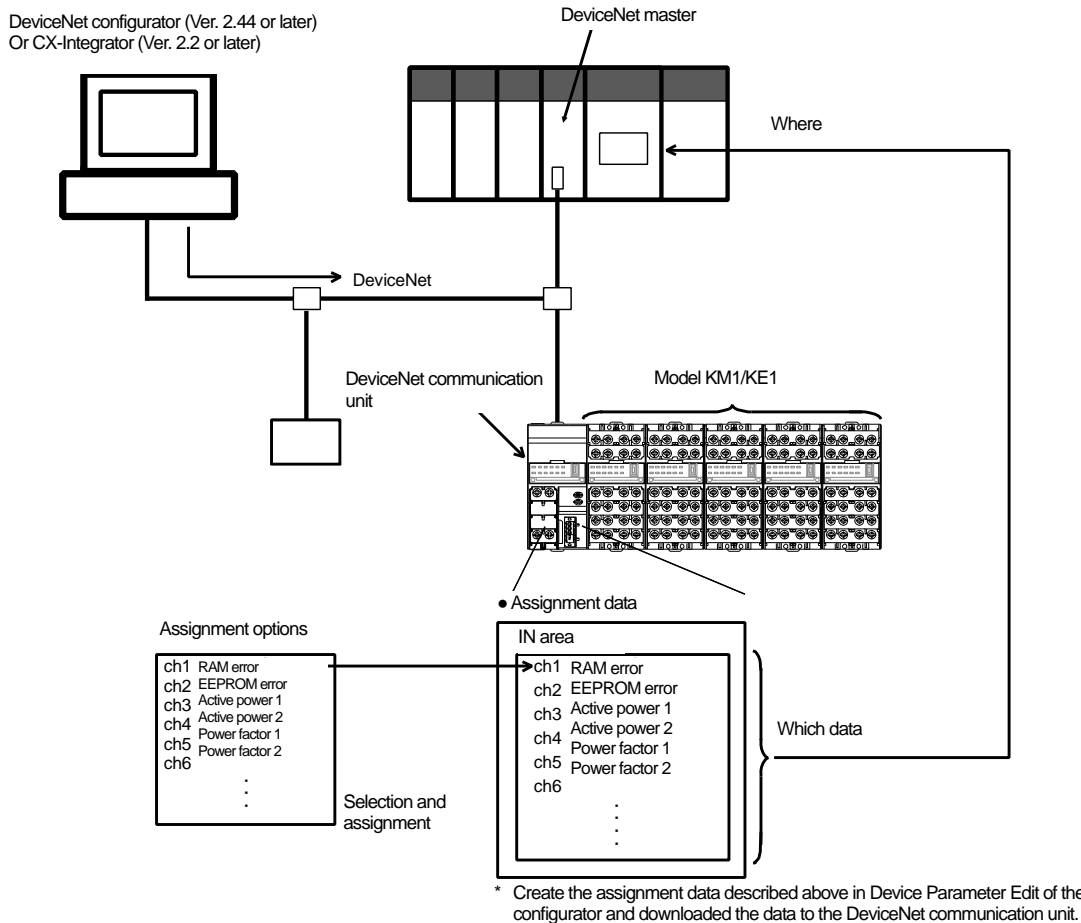

### Setting of Assignment Data

#### ● Creation of assignment data

- (1) Create assignment data in the DeviceNet Parameter Edit window of the configurator.  
You can select desired data from the list of assignment options and assign them to the IN area of the DeviceNet communication unit.
- (2) Downloaded the created assignment data to the DeviceNet communication unit.  
Clicking on the download button of the configurator allows writing the created assignment data into the DeviceNet communication unit.

\* For information on the list of assignment options, refer to page 4-13.

\* If the CS/CJ series is used as high-order device (PLC, PC), using two connections allow the IN area to be divided into two parts and data to be assigned to each part.

## ● Assignment range

The following describes the assignment range for I/O assignment with configurator.

- IN area : 32 to 61 channels (Desired number of items of data can be assigned)
- OUT area : 1ch

- \* The assignment range is 32 channels at minimum. Note that when the number of channels used for assignment selection is only 1 channel, the remaining 31 channels are treated as vacant channels occupying the assignment range.
- \* The number of DeviceNet communication units that can be connected to a high-order device (PLC, PC) is restricted. When using the method of I/O assignment with configurator to assign data for remote I/O communication, refer to the example below.

Example: When the high-order device (PLC, PC) is CS1/CJ1 series manufactured by Omron I/O assignment with configurator allows assigning data of 32 channels at minimum and 61 channels at maximum. For example, if the assignment data is 61 channels and the assignment size of the high-order device (PLC, PC) is 64 channels, only one DeviceNet communication unit can be connected.

When the assignment data is 32 channels

	Max. assignment size per high-order device (PLC, PC)	
DeviceNet communication unit	32ch	32ch
High-order device (PLC, PC) (CS1/CJ1 series)	64ch (In the case of predetermined data assignment) Note 1	500 channels x 2 blocks (In the case of desired data assignment) Note 1
Max. number of connected DeviceNet communication units	2 units	31 units

When the assignment data is 61 channels

	Max. assignment size per high-order device (PLC, PC)	
DeviceNet communication unit	61ch	61ch
High-order device (PLC, PC) (CS1/CJ1 series)	64ch (In the case of predetermined data assignment) Note 1	500 channels x 2 blocks (In the case of desired data assignment) Note 1
Max. number of connected DeviceNet communication units	1 unit	16 units

Note 1: Predetermined and desired data assignments are the methods of assigning data of the DeviceNet communication unit to a high-order device (PLC, PC). For details, refer to "4.4 Assignment of Data to High-Order Device."

### Information

The maximum assignment size (61 channels) in the IN area is the limit of this communication unit and not the limit of assignment size of the high-order device. For details on the assignment size of each high-order device, refer to the User's Manual of each high-order device.

### Information

Setting a large amount of assignment data may cause the lack of the assignment area used for other DeviceNet slave units and a load to be put on the network. We recommend that data assignment is restricted to the items that need to be read/written often and other items are read/written by Explicit messages.

● DeviceNet configurator (Ver. 2.44 or later)  
(Or data creation method with CX-Integrator Ver. 2.2 or later)

If the connection with the configurator is not successful, make settings on the master side. This arises from the fact that the message timeout on the master side is short or the I/O size assigned to the master side is different from that in the DeviceNet communication unit. For information on the setting method, refer to "■ Preparation of Configurator Connection" (page 5-3).

- (1) Select DeviceNet communication unit in the Network Configuration window. Double click on it or right click on [Parameter] > [Edit] to display the [Device Parameter Edit] window.



- \*1. Clicking on the [Upload] button allows reading all parameters in the DeviceNet communication unit. Simultaneously, the display of this window is also updated.
- \*2. Clicking on the [Download] button allows writing all settings configured on the configurator at the point into the DeviceNet communication unit.
- \*3. Clicking on the [Compare] button allows comparing parameters configured on the configurator and the ones in the DeviceNet communication unit.

**Information**

If the master is the DeviceNet unit for CS/CJ series, the IN area can be divided into two. In that case, drag data to either right or left IN area (assignment area 1, assignment area 2). In addition, it is necessary to set two connections between the high-order device (PLC, PC) and the DeviceNet communication unit in User Definition of Device Parameter Edit in the master. For details, refer to "■ Connection Setting for Dividing IN Area into Two."

**Information**

- If a parameter of a unit not included in the configuration is assigned, any processing is not done for the parameter.

- (2) Be sure to click on the [OK] button to close the [Device Parameter Edit] window.



### ● Screen description (DeviceNet Parameter Edit window)

Using the configurator, create assignment data. Then download them to the DeviceNet communication unit. You can select desired data from the list of assignment options and assign them to the IN area.



Item	Description
[Restore Default] button	Initializes all settings of the DeviceNet communication unit and restores the factory default settings. However, the factory default settings are restored on the configurator screen only, click on the [Download] button to write the settings. * Using this function requires changing the setting of the message monitor timer. For details, refer to page 6-6.
[Upload] button	Reads the settings of the DeviceNet communication unit.
[Download] button	Writes the settings on the configurator into the DeviceNet communication unit.
[Compare] button	Compare the settings on the configurator and the settings of each unit.
[Reset] button	Resets the portion of the DeviceNet communication only. (The state of the connection of multiple units is not cancelled.)

\* [Upload], [Download], and [Compare] buttons are operative only when the CompoWay/F setting is enabled.

## List of Assignment Options

Status data and measured instantaneous values (partial) can be assigned. For details, refer to the list below. For details on assignment data, refer to "Model KM1 User's Manual" (KANC-701) and "Model KE1 User's Manual" (SGTE-717).

\* Data not included in the list, such as logging data, integrated values, pulse count, can be read with Explicit messages. For information on how to read data, refer to page 6-3.

### ● Status (ch0, ch1)

IN area Assignment possible	Set value	Name of assignment data	PMU1	PMU2	PGR	PVS	VSU	VAU	EMU	CTD	ZCT
○	00	RAM error (E-M1)	○	○	○	○	○	○	○	○	○
○	01	EEPROM error (E-M2)	○	○	○	○	○	○	○	○	○
○	02	EEPROM error (E-M3)	○	○	○	○	○	○	○	○	○
○	03	RTC error (E-T1)	○	○	○	○	○	○	○	×	×
○	04	Communication error	○	○	○	○	○	○	○	×	×
○	05	Operation mode	○	○	○	○	○	○	○	○	○
○	06	Voltage input limit exceeded (E-S1)	○	○	○	○	○	○	×	×	×
○	07	Current input limit exceeded (E-S2)	○	○	○	○	×	○	×	○	×
○	08	Insufficient voltage input	○	○	○	○	○	○	×	×	×
○	09	Frequency input error (E-S3)	○	○	○	○	○	○	×	×	×
○	0A	Input 1	○	○	○	○	×	○	×	○	○
○	0B	Input 2	○	○	○	○	×	○	×	○	○
○	0C	Input 3	○	○	○	○	×	○	×	○	○
○	0D	Input 4	×	○	×	×	×	×	×	○	○
○	0E	Input 5	×	×	×	×	×	×	×	○	○
○	0F	Input 6	×	×	×	×	×	×	×	○	○
○	10	Input 7	×	×	×	×	×	×	×	○	○
○	11	Input 8	×	×	×	×	×	×	×	○	○
○	12	OUT1	○	○	○	○	○	○	○	○	○
○	13	OUT2	○	○	○	○	○	○	○	×	×
○	14	OUT3	○	○	×	×	×	×	○	×	×
○	15	Low state 1	○	○	×	×	×	×	×	×	×
○	16	Middle state 1	○	○	×	×	×	×	×	×	×
○	17	High state 1	○	○	×	×	×	×	×	×	×
○	18	Low state 2	×	○	×	×	×	×	×	×	×
○	19	Middle state 2	×	○	×	×	×	×	×	×	×
○	1A	High state 2	×	○	×	×	×	×	×	×	×
○	1B	Vacant	-	-	-	-	-	-	-	-	-
○	1C	Alarm 1	○	○	○	○	○	○	○	○	○
○	1D	Alarm 2	×	○	×	×	×	×	×	○	×
○	1E	Vacant	-	-	-	-	-	-	-	-	-
○	1F	Vacant	-	-	-	-	-	-	-	-	-

● Measurement parameter (ch2 to ch60)

IN area Assignment possible	Set value	Parameter name	PMU1	PMU2	PGR	PVS	VSU	VAU	EMU	CTD	ZCT
<input type="radio"/>	0000	Vacant	-	-	-	-	-	-	-	-	-
<input type="radio"/>	0001	Voltage 1	<input type="radio"/>	<input type="radio"/>	<input type="radio"/>	<input type="radio"/>	<input type="radio"/>	<input type="radio"/>	<input checked="" type="checkbox"/>	<input checked="" type="checkbox"/>	<input checked="" type="checkbox"/>
<input type="radio"/>	0002	Voltage 2	<input type="radio"/>	<input type="radio"/>	<input type="radio"/>	<input type="radio"/>	<input type="radio"/>	<input type="radio"/>	<input checked="" type="checkbox"/>	<input checked="" type="checkbox"/>	<input checked="" type="checkbox"/>
<input type="radio"/>	0003	Voltage 3	<input type="radio"/>	<input type="radio"/>	<input type="radio"/>	<input type="radio"/>	<input type="radio"/>	<input type="radio"/>	<input checked="" type="checkbox"/>	<input checked="" type="checkbox"/>	<input checked="" type="checkbox"/>
<input type="radio"/>	0004	Voltage 4	<input type="radio"/>	<input type="radio"/>	<input type="radio"/>	<input type="radio"/>	<input type="radio"/>	<input type="radio"/>	<input checked="" type="checkbox"/>	<input checked="" type="checkbox"/>	<input checked="" type="checkbox"/>
<input type="radio"/>	0005	Voltage 5	<input type="radio"/>	<input type="radio"/>	<input type="radio"/>	<input type="radio"/>	<input type="radio"/>	<input type="radio"/>	<input checked="" type="checkbox"/>	<input checked="" type="checkbox"/>	<input checked="" type="checkbox"/>
<input type="radio"/>	0006	Voltage 6	<input type="radio"/>	<input type="radio"/>	<input type="radio"/>	<input type="radio"/>	<input type="radio"/>	<input type="radio"/>	<input checked="" type="checkbox"/>	<input checked="" type="checkbox"/>	<input checked="" type="checkbox"/>
<input type="radio"/>	0007	Current 1	<input type="radio"/>	<input type="radio"/>	<input type="radio"/>	<input type="radio"/>	<input checked="" type="checkbox"/>	<input type="radio"/>	<input checked="" type="checkbox"/>	<input type="radio"/>	<input checked="" type="checkbox"/>
<input type="radio"/>	0008	Current 2	<input type="radio"/>	<input type="radio"/>	<input type="radio"/>	<input type="radio"/>	<input checked="" type="checkbox"/>	<input type="radio"/>	<input checked="" type="checkbox"/>	<input type="radio"/>	<input checked="" type="checkbox"/>
<input type="radio"/>	0009	Current 3	<input type="radio"/>	<input type="radio"/>	<input type="radio"/>	<input type="radio"/>	<input checked="" type="checkbox"/>	<input type="radio"/>	<input checked="" type="checkbox"/>	<input type="radio"/>	<input checked="" type="checkbox"/>
<input type="radio"/>	000A	Current 4	<input checked="" type="checkbox"/>	<input checked="" type="checkbox"/>	<input checked="" type="checkbox"/>	<input checked="" type="checkbox"/>	<input checked="" type="checkbox"/>	<input checked="" type="checkbox"/>	<input checked="" type="checkbox"/>	<input type="radio"/>	<input checked="" type="checkbox"/>
<input type="radio"/>	000B	Current 5	<input checked="" type="checkbox"/>	<input checked="" type="checkbox"/>	<input checked="" type="checkbox"/>	<input checked="" type="checkbox"/>	<input checked="" type="checkbox"/>	<input checked="" type="checkbox"/>	<input checked="" type="checkbox"/>	<input type="radio"/>	<input checked="" type="checkbox"/>
<input type="radio"/>	000C	Current 6	<input checked="" type="checkbox"/>	<input checked="" type="checkbox"/>	<input checked="" type="checkbox"/>	<input checked="" type="checkbox"/>	<input checked="" type="checkbox"/>	<input checked="" type="checkbox"/>	<input checked="" type="checkbox"/>	<input type="radio"/>	<input checked="" type="checkbox"/>
<input type="radio"/>	000D	Current 7	<input checked="" type="checkbox"/>	<input type="radio"/>	<input checked="" type="checkbox"/>	<input checked="" type="checkbox"/>	<input checked="" type="checkbox"/>	<input checked="" type="checkbox"/>	<input checked="" type="checkbox"/>	<input type="radio"/>	<input checked="" type="checkbox"/>
<input type="radio"/>	000E	Current 8	<input checked="" type="checkbox"/>	<input type="radio"/>	<input checked="" type="checkbox"/>	<input checked="" type="checkbox"/>	<input checked="" type="checkbox"/>	<input checked="" type="checkbox"/>	<input checked="" type="checkbox"/>	<input type="radio"/>	<input checked="" type="checkbox"/>
<input type="radio"/>	000F	Current 9	<input checked="" type="checkbox"/>	<input type="radio"/>	<input checked="" type="checkbox"/>	<input checked="" type="checkbox"/>	<input checked="" type="checkbox"/>	<input checked="" type="checkbox"/>	<input checked="" type="checkbox"/>	<input type="radio"/>	<input checked="" type="checkbox"/>
<input type="radio"/>	0010	Current 10	<input checked="" type="checkbox"/>	<input checked="" type="checkbox"/>	<input checked="" type="checkbox"/>	<input checked="" type="checkbox"/>	<input checked="" type="checkbox"/>	<input checked="" type="checkbox"/>	<input checked="" type="checkbox"/>	<input type="radio"/>	<input checked="" type="checkbox"/>
<input type="radio"/>	0011	Current 11	<input checked="" type="checkbox"/>	<input checked="" type="checkbox"/>	<input checked="" type="checkbox"/>	<input checked="" type="checkbox"/>	<input checked="" type="checkbox"/>	<input checked="" type="checkbox"/>	<input checked="" type="checkbox"/>	<input type="radio"/>	<input checked="" type="checkbox"/>
<input type="radio"/>	0012	Current 12	<input checked="" type="checkbox"/>	<input checked="" type="checkbox"/>	<input checked="" type="checkbox"/>	<input checked="" type="checkbox"/>	<input checked="" type="checkbox"/>	<input checked="" type="checkbox"/>	<input checked="" type="checkbox"/>	<input type="radio"/>	<input checked="" type="checkbox"/>
<input type="radio"/>	0013	Power factor 1	<input type="radio"/>	<input type="radio"/>	<input type="radio"/>	<input type="radio"/>	<input checked="" type="checkbox"/>	<input checked="" type="checkbox"/>	<input checked="" type="checkbox"/>	<input type="radio"/>	<input checked="" type="checkbox"/>
<input type="radio"/>	0014	Power factor 2	<input type="radio"/>	<input type="radio"/>	<input type="radio"/>	<input type="radio"/>	<input checked="" type="checkbox"/>	<input checked="" type="checkbox"/>	<input checked="" type="checkbox"/>	<input type="radio"/>	<input checked="" type="checkbox"/>
<input type="radio"/>	0015	Power factor 3	<input type="radio"/>	<input checked="" type="checkbox"/>	<input type="radio"/>	<input type="radio"/>	<input checked="" type="checkbox"/>	<input checked="" type="checkbox"/>	<input checked="" type="checkbox"/>	<input type="radio"/>	<input checked="" type="checkbox"/>
<input type="radio"/>	0016	Power factor 4	<input checked="" type="checkbox"/>	<input checked="" type="checkbox"/>	<input checked="" type="checkbox"/>	<input checked="" type="checkbox"/>	<input checked="" type="checkbox"/>	<input checked="" type="checkbox"/>	<input checked="" type="checkbox"/>	<input type="radio"/>	<input checked="" type="checkbox"/>
<input type="radio"/>	0017	Power factor 5	<input checked="" type="checkbox"/>	<input type="radio"/>	<input checked="" type="checkbox"/>	<input checked="" type="checkbox"/>	<input checked="" type="checkbox"/>	<input checked="" type="checkbox"/>	<input checked="" type="checkbox"/>	<input type="radio"/>	<input checked="" type="checkbox"/>
<input type="radio"/>	0018	Power factor 6	<input checked="" type="checkbox"/>	<input type="radio"/>	<input checked="" type="checkbox"/>	<input checked="" type="checkbox"/>	<input checked="" type="checkbox"/>	<input checked="" type="checkbox"/>	<input checked="" type="checkbox"/>	<input type="radio"/>	<input checked="" type="checkbox"/>
<input type="radio"/>	0019	Power factor 7	<input checked="" type="checkbox"/>	<input checked="" type="checkbox"/>	<input checked="" type="checkbox"/>	<input checked="" type="checkbox"/>	<input checked="" type="checkbox"/>	<input checked="" type="checkbox"/>	<input checked="" type="checkbox"/>	<input type="radio"/>	<input checked="" type="checkbox"/>
<input type="radio"/>	001A	Power factor 8	<input checked="" type="checkbox"/>	<input checked="" type="checkbox"/>	<input checked="" type="checkbox"/>	<input checked="" type="checkbox"/>	<input checked="" type="checkbox"/>	<input checked="" type="checkbox"/>	<input checked="" type="checkbox"/>	<input type="radio"/>	<input checked="" type="checkbox"/>
<input type="radio"/>	001B	Frequency 1	<input type="radio"/>	<input type="radio"/>	<input type="radio"/>	<input type="radio"/>	<input type="radio"/>	<input type="radio"/>	<input checked="" type="checkbox"/>	<input checked="" type="checkbox"/>	<input checked="" type="checkbox"/>
<input type="radio"/>	001C	Frequency 2	<input checked="" type="checkbox"/>	<input type="radio"/>	<input checked="" type="checkbox"/>	<input checked="" type="checkbox"/>	<input checked="" type="checkbox"/>	<input checked="" type="checkbox"/>	<input checked="" type="checkbox"/>	<input checked="" type="checkbox"/>	<input checked="" type="checkbox"/>
<input type="radio"/>	001D	Active power 1	<input type="radio"/>	<input type="radio"/>	<input type="radio"/>	<input type="radio"/>	<input checked="" type="checkbox"/>	<input checked="" type="checkbox"/>	<input checked="" type="checkbox"/>	<input type="radio"/>	<input checked="" type="checkbox"/>
<input type="radio"/>	001E	Active power 2	<input type="radio"/>	<input type="radio"/>	<input type="radio"/>	<input type="radio"/>	<input checked="" type="checkbox"/>	<input checked="" type="checkbox"/>	<input checked="" type="checkbox"/>	<input type="radio"/>	<input checked="" type="checkbox"/>
<input type="radio"/>	001F	Active power 3	<input type="radio"/>	<input checked="" type="checkbox"/>	<input type="radio"/>	<input type="radio"/>	<input checked="" type="checkbox"/>	<input checked="" type="checkbox"/>	<input checked="" type="checkbox"/>	<input type="radio"/>	<input checked="" type="checkbox"/>
<input type="radio"/>	0020	Active power 4	<input checked="" type="checkbox"/>	<input checked="" type="checkbox"/>	<input checked="" type="checkbox"/>	<input checked="" type="checkbox"/>	<input checked="" type="checkbox"/>	<input checked="" type="checkbox"/>	<input checked="" type="checkbox"/>	<input type="radio"/>	<input checked="" type="checkbox"/>
<input type="radio"/>	0021	Active power 5	<input checked="" type="checkbox"/>	<input type="radio"/>	<input checked="" type="checkbox"/>	<input checked="" type="checkbox"/>	<input checked="" type="checkbox"/>	<input checked="" type="checkbox"/>	<input checked="" type="checkbox"/>	<input type="radio"/>	<input checked="" type="checkbox"/>
<input type="radio"/>	0022	Active power 6	<input checked="" type="checkbox"/>	<input type="radio"/>	<input checked="" type="checkbox"/>	<input checked="" type="checkbox"/>	<input checked="" type="checkbox"/>	<input checked="" type="checkbox"/>	<input checked="" type="checkbox"/>	<input type="radio"/>	<input checked="" type="checkbox"/>
<input type="radio"/>	0023	Active power 7	<input checked="" type="checkbox"/>	<input checked="" type="checkbox"/>	<input checked="" type="checkbox"/>	<input checked="" type="checkbox"/>	<input checked="" type="checkbox"/>	<input checked="" type="checkbox"/>	<input checked="" type="checkbox"/>	<input type="radio"/>	<input checked="" type="checkbox"/>
<input type="radio"/>	0024	Active power 8	<input checked="" type="checkbox"/>	<input checked="" type="checkbox"/>	<input checked="" type="checkbox"/>	<input checked="" type="checkbox"/>	<input checked="" type="checkbox"/>	<input checked="" type="checkbox"/>	<input checked="" type="checkbox"/>	<input type="radio"/>	<input checked="" type="checkbox"/>
<input type="radio"/>	0025	Reactive power 1	<input type="radio"/>	<input type="radio"/>	<input type="radio"/>	<input type="radio"/>	<input checked="" type="checkbox"/>	<input checked="" type="checkbox"/>	<input checked="" type="checkbox"/>	<input type="radio"/>	<input checked="" type="checkbox"/>
<input type="radio"/>	0026	Reactive power 2	<input type="radio"/>	<input type="radio"/>	<input type="radio"/>	<input type="radio"/>	<input checked="" type="checkbox"/>	<input checked="" type="checkbox"/>	<input checked="" type="checkbox"/>	<input type="radio"/>	<input checked="" type="checkbox"/>
<input type="radio"/>	0027	Reactive power 3	<input type="radio"/>	<input checked="" type="checkbox"/>	<input type="radio"/>	<input type="radio"/>	<input checked="" type="checkbox"/>	<input checked="" type="checkbox"/>	<input checked="" type="checkbox"/>	<input type="radio"/>	<input checked="" type="checkbox"/>
<input type="radio"/>	0028	Reactive power 4	<input checked="" type="checkbox"/>	<input checked="" type="checkbox"/>	<input checked="" type="checkbox"/>	<input checked="" type="checkbox"/>	<input checked="" type="checkbox"/>	<input checked="" type="checkbox"/>	<input checked="" type="checkbox"/>	<input type="radio"/>	<input checked="" type="checkbox"/>
<input type="radio"/>	0029	Reactive power 5	<input checked="" type="checkbox"/>	<input type="radio"/>	<input checked="" type="checkbox"/>	<input checked="" type="checkbox"/>	<input checked="" type="checkbox"/>	<input checked="" type="checkbox"/>	<input checked="" type="checkbox"/>	<input type="radio"/>	<input checked="" type="checkbox"/>
<input type="radio"/>	002A	Reactive power 6	<input checked="" type="checkbox"/>	<input type="radio"/>	<input checked="" type="checkbox"/>	<input checked="" type="checkbox"/>	<input checked="" type="checkbox"/>	<input checked="" type="checkbox"/>	<input checked="" type="checkbox"/>	<input type="radio"/>	<input checked="" type="checkbox"/>
<input type="radio"/>	002B	Reactive power 7	<input checked="" type="checkbox"/>	<input checked="" type="checkbox"/>	<input checked="" type="checkbox"/>	<input checked="" type="checkbox"/>	<input checked="" type="checkbox"/>	<input checked="" type="checkbox"/>	<input checked="" type="checkbox"/>	<input type="radio"/>	<input checked="" type="checkbox"/>
<input type="radio"/>	002C	Reactive power 8	<input checked="" type="checkbox"/>	<input checked="" type="checkbox"/>	<input checked="" type="checkbox"/>	<input checked="" type="checkbox"/>	<input checked="" type="checkbox"/>	<input checked="" type="checkbox"/>	<input checked="" type="checkbox"/>	<input type="radio"/>	<input checked="" type="checkbox"/>
<input type="radio"/>	002D	Temperature 1	<input checked="" type="checkbox"/>	<input checked="" type="checkbox"/>	<input checked="" type="checkbox"/>	<input checked="" type="checkbox"/>	<input checked="" type="checkbox"/>	<input checked="" type="checkbox"/>	<input type="radio"/>	<input checked="" type="checkbox"/>	<input checked="" type="checkbox"/>
<input type="radio"/>	0035	Leakage current 1	<input checked="" type="checkbox"/>	<input checked="" type="checkbox"/>	<input type="radio"/>	<input checked="" type="checkbox"/>	<input checked="" type="checkbox"/>	<input checked="" type="checkbox"/>	<input checked="" type="checkbox"/>	<input checked="" type="checkbox"/>	<input type="radio"/>
<input type="radio"/>	0036	Leakage current 2	<input checked="" type="checkbox"/>	<input checked="" type="checkbox"/>	<input checked="" type="checkbox"/>	<input checked="" type="checkbox"/>	<input checked="" type="checkbox"/>	<input checked="" type="checkbox"/>	<input checked="" type="checkbox"/>	<input checked="" type="checkbox"/>	<input type="radio"/>
<input type="radio"/>	0037	Leakage current 3	<input checked="" type="checkbox"/>	<input checked="" type="checkbox"/>	<input checked="" type="checkbox"/>	<input checked="" type="checkbox"/>	<input checked="" type="checkbox"/>	<input checked="" type="checkbox"/>	<input checked="" type="checkbox"/>	<input checked="" type="checkbox"/>	<input type="radio"/>
<input type="radio"/>	0038	Leakage current 4	<input checked="" type="checkbox"/>	<input checked="" type="checkbox"/>	<input checked="" type="checkbox"/>	<input checked="" type="checkbox"/>	<input checked="" type="checkbox"/>	<input checked="" type="checkbox"/>	<input checked="" type="checkbox"/>	<input checked="" type="checkbox"/>	<input type="radio"/>
<input type="radio"/>	0039	Leakage current 5	<input checked="" type="checkbox"/>	<input checked="" type="checkbox"/>	<input checked="" type="checkbox"/>	<input checked="" type="checkbox"/>	<input checked="" type="checkbox"/>	<input checked="" type="checkbox"/>	<input checked="" type="checkbox"/>	<input checked="" type="checkbox"/>	<input type="radio"/>
<input type="radio"/>	003A	Leakage current 6	<input checked="" type="checkbox"/>	<input checked="" type="checkbox"/>	<input checked="" type="checkbox"/>	<input checked="" type="checkbox"/>	<input checked="" type="checkbox"/>	<input checked="" type="checkbox"/>	<input checked="" type="checkbox"/>	<input checked="" type="checkbox"/>	<input type="radio"/>
<input type="radio"/>	003B	Leakage current 7	<input checked="" type="checkbox"/>	<input checked="" type="checkbox"/>	<input checked="" type="checkbox"/>	<input checked="" type="checkbox"/>	<input checked="" type="checkbox"/>	<input checked="" type="checkbox"/>	<input checked="" type="checkbox"/>	<input checked="" type="checkbox"/>	<input type="radio"/>
<input type="radio"/>	003C	Leakage current 8	<input checked="" type="checkbox"/>	<input checked="" type="checkbox"/>	<input checked="" type="checkbox"/>	<input checked="" type="checkbox"/>	<input checked="" type="checkbox"/>	<input checked="" type="checkbox"/>	<input checked="" type="checkbox"/>	<input checked="" type="checkbox"/>	<input type="radio"/>

## 4.4 Assignment of Assignment Data to High-Order Device

The data for remote I/O communication created by simple assignment or I/O assignment with configurator can be assigned to a high-order device (PLC, PC) using either predetermined or desired assignment method.

### ■ Assignment to High-Order Device

#### ● Predetermined assignment

The area of a high-order device (PLC, PC) to which the data for remote I/O communication is assigned is automatically determined on the basis of the node address of the DeviceNet communication unit. However, note that as an area of 1 channel is allocated to one node address in the predetermined assignment, the node address allocated to a channel occupied by the DeviceNet communication unit cannot be used by another DeviceNet slave unit.

#### ● Desired assignment

Using the configurator, the data for remote I/O communication is assigned to the desired position of a high-order device (CPU unit).

### ■ Setting by DeviceNet Configurator

The configurator assigns data to a high-order device. Follow the steps (1) to (6) described below. However, note that the procedure is different depending on the assignment method.

- Perform steps (1) to (3) for the predetermined assignment.
- Perform steps (1) to (6) for desired assignment.

- (1) Double click on the icon of the high-order device (master unit) on the Network Configuration window or right click on [Device] > [Parameter] > [Edit] to display the [Device Parameter Edit] window of the high-order device (PLC, PC).
- (2) Click on the button for registration in the [Master General] tab to register the DeviceNet communication unit. Or in the Network Configuration window, drag the icon of the DeviceNet communication unit to the icon of the high-order device (master unit) to register the communication unit.

After the registration, the DeviceNet communication unit is added to the [List of Registered Devices]. This allows registering the assignment data created in the [Device Parameter Edit] screen of a slave in the high-order device (PLC/PC).

Button for registration

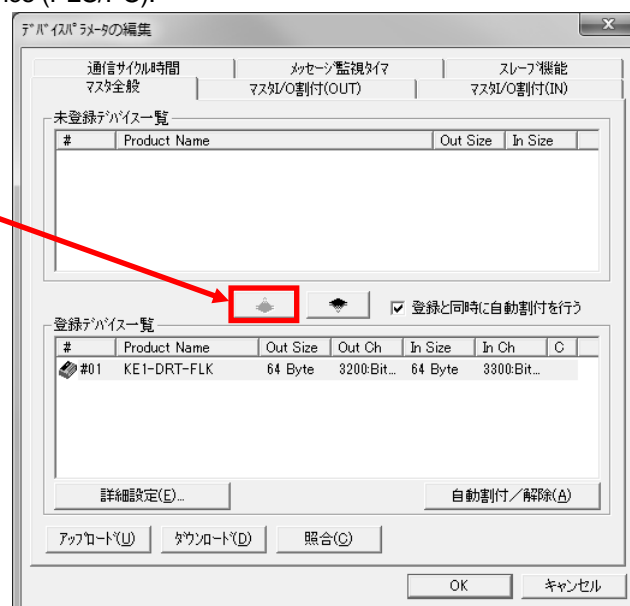

- (3) In the [Master I/O Assignment] (OUT or IN) tab, check whether the assignment data created in the Parameter Edit of the DeviceNet communication unit is registered in the assignment area (memory block 1 or 2) of the high-order device (PLC/PC).

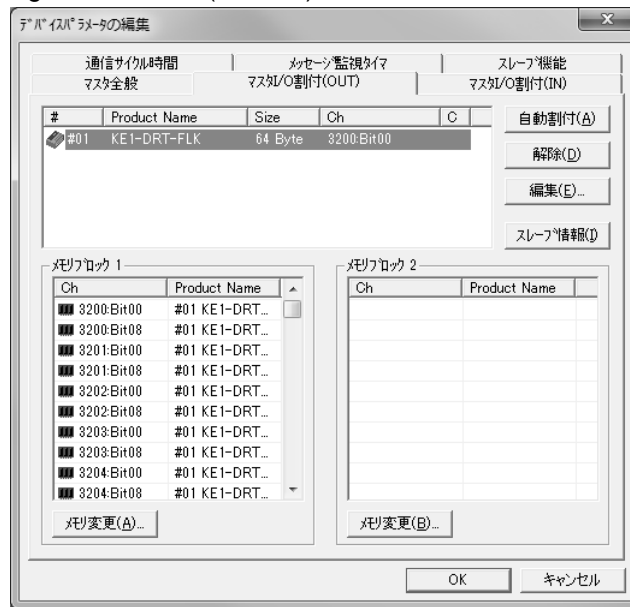

- (4) Click on the [Edit] button and edit I/O assignment.  
Specify assignment channel to define the location in the IN/OUT area of the high-order device (PLC/PC).  
If the IN/OUT area of the high-order device (PLC/PC) has two blocks, specify the block to which data is assigned.

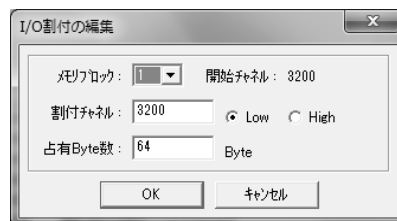

- (5) Click on the [OK] button to return to the [Device Parameter Edit] window of the high-order device (PLC, PC).  
The data of the DeviceNet communication unit are registered in the intended location of Memory Block 1 or 2 at the lower half of the window.
- (6) Return to the [Master General] tab and click on the [Download] button to write the specified data assignment in the I/O memory into the high-order device (PLC/PC).

\* (2) Be sure to click on the [OK] button to close the [Device Parameter Edit] window of the high-order device (PLC/PC). Closing the window with the [Cancel] or [x] button cancels the settings.

**Note:**

The IN area of the DeviceNet communication unit is larger than that of other slaves. Make sure that the IN area does not extend beyond the area for the DeviceNet or overlap with the area for another slave.

**Information**

However, note that as an area of 1 channel is allocated to one node address in simple assignment, the node address allocated to a channel occupied by the DeviceNet communication unit cannot be used in another node.

- In the case of the DeviceNet unit for CS/CJ series, setting an assignment DM area allows specifying the location and size of the area for DeviceNet without using the configurator. However, slaves are assigned to the area for DeviceNet in the order of node addresses. For details, refer to "CS/CJ series DeviceNet Unit User's Manual" (SBCD-314).

## ■ Connection Setting for Dividing IN Area into Two

If the DeviceNet unit for CS/CJ series is used as high-order device (PLC/PC), setting connections allows dividing the IN area into two.

Two connections per one DeviceNet communication unit are set in User Definition so that they can be used simultaneously.

In the DeviceNet communication unit, one connection allows the data exchange of [IN1] and [OUT1] and another connection allows the data exchange of [IN2].

The connections and their paths used by default are shown below.

	Used connection	Used connection path
IN assignment area 1	Poll connection	CH0 – CH31 In Data
OUT assignment area 1	Poll connection	Poll Out Data
IN assignment area 2	None	None

The user setting shown below allows dividing the IN area into two and using both of them.

	Used connection	Used connection path
IN assignment area 1	Poll connection	CH0 – CH31 In Data
OUT assignment area 1	Poll connection	Poll Out Data
IN assignment area 2	Cyclic connection	CH32 – CH60 In Data

- Setting method by DeviceNet configurator: Select the icon of the DeviceNet communication unit. Right click on the icon and then select Property to display [KE1-DRT-FLK Property]. Select the [I/O Information] tab and click on the [Edit] button to display the [I/O Size Change] window.

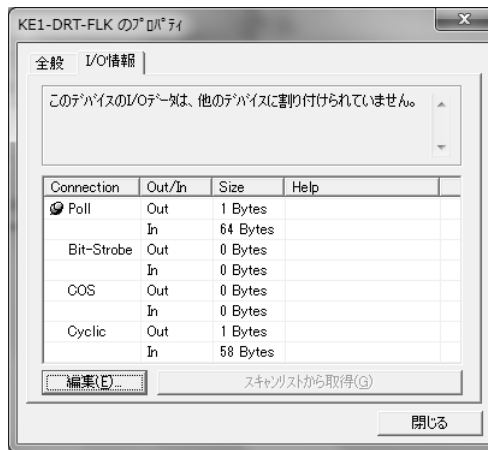

- (2) Change the OUT and IN sizes of the COS or Cyclic to be used.

Set the value same as the OUT size of the Poll as OUT size and set the size used in "Assignment Area 2" of "I/O Assignment (IN)" of the DeviceNet communication unit as IN size.



- (3) In the [Master General] tab of the [Device Parameter Edit] window of the high-order device (PLC/PC), select a unit and click on [Detailed Settings] button to display the [Connection] tab.



- (4) Check the radio button for [Connection User Settings]. For one connection, check the checkbox for [Use of Poll connection] (default). Select [Poll Out Data] as OUT side connection path and [CH0-CH31 In Data] as IN side connection path from the pulldown lists. For the other connection, check the checkbox for [Use Cyclic Connection]. As IN side connection path, select [CH32-CH60 In Data] from the pulldown list. In the [Master General] tab of the [Device Parameter Edit] window of the high-order device (PLC/PC), select the unit and click on the [Detailed Settings] button to display the [Connection] tab.

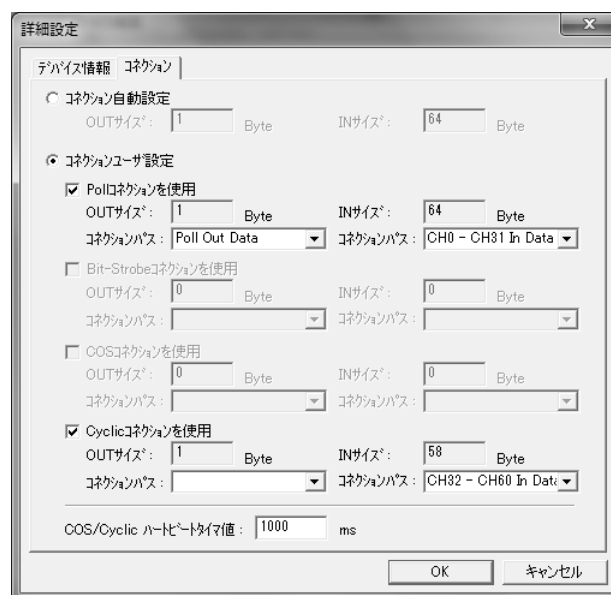



# Chapter 5 Operations with Configurator

5.1	List of Operations with Configurator.....	5-2
5.2	Operation from Device Parameter Edit Window of DeviceNet Communication Unit.....	5-3
	■ Preparations of Configurator Connection.....	5-3
	● When the configurator is connected through the DeviceNet I/F board (card) .....	5-3
	● When high-order device (PLC, PC) is connected through serial communication.....	5-3
	■ Displaying Device Parameter Edit window .....	5-5
	■ Setting of Description on DeviceNet Communication Unit.....	5-6
	● Setting method.....	5-6
5.3	Maintenance Mode Screen .....	5-7
	■ What is Maintenance Mode Screen? .....	5-7
	● Setting method.....	5-7

## 5.1 List of Operations with Configurator

This chapter describes the settings and operations available with the configurator except for the ones explained in "Chapter 4 Remote I/O Function."

Settings and operations are available with the configurator in several ways. The following shows an example of operations.

**Note:** For the settings and monitoring of the DeviceNet communication unit, be sure to use the configurator Ver. 2.44 or later or CX-Integrator Ver. 2.2 or later.

Item	Reference page
Device Parameter Edit window of high-order device	-
Registration of DeviceNet communication unit in High-Order Device	Page 4-14
Connection setting for DeviceNet communication unit	Page 3-12
Assignment to High-Order Device	Page 4-14
Device Parameter Edit window of DeviceNet communication unit	Page 5-3
Device Monitor window	-
[Status] tab	-
Master status display	-
Slave status display	-
[Unit Status] tab	-
Unit status display	-
Master function status display	-
Slave function status display	-
[Communication Cycle Time] tab	-
Display of current, max., and min. values of communication cycle time	-
[Error History] tab	-
Display of communication error history	-

## 5.2 Operation from Device Parameter Edit Window of DeviceNet Communication Unit

### ■ Preparations of Configurator Connection

If the connection with the configurator is not successful, make settings in the master side as shown below. This arises from the fact that the message timeout on the master side is short or the I/O size assigned to the master side is different from that in the DeviceNet communication unit.

- When the configurator is connected through the DeviceNet I/F board (card)
  - (1) Right click on the icon of the master and select [Monitor] to display the [Device Monitor] screen.
  - (2) Click on the [Stop Remote I/O Communication] button to stop the remote I/O communication with the DeviceNet communication unit.

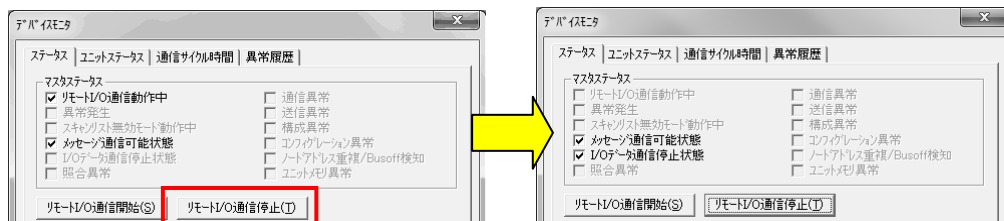

#### Information

The operations described above are unnecessary if no error is given on the master side.

- When high-order device (PLC, PC) is connected through serial communication
  - (1) Double click on the icon of the high-order device (PLC, PC) to display the [Device Parameter Edit] screen, and select the [Message Monitor Timer] tab.
  - (2) Double click on the unit No. of the DeviceNet communication unit, set [5000 ms] in the [Message Monitor Timer Setting] screen, and click on the [OK] button.



- (3) Click on the [Download] button in the [General] tab of the [Device Parameter Edit] screen to start downloading.

## ■ Displaying Device Parameter Edit window

- (1) Turn on the DeviceNet communication unit and high-order device (PLC, PC) in advance. Turn on the configurator and select [Network] > [Upload].  
The configuration of the units connected to the network are read and shown in the Network Configuration window.
- (2) Double click on the icon of the DeviceNet communication unit on the Network Configuration window. Or right click on the icon and select [Parameter] > [Edit] to display the [Device Parameter Edit] window of the DeviceNet communication unit.



### Information

- Clicking on the [Reset] button allows all Model KM1/KE1 units connected to the DeviceNet communication unit to be reset and brought to the state that is caused when the power is turned on again. However, Model KM1/KE1 units in operation are not reset.
- Clicking on the [Restore Default] button allows returning all settings of the DeviceNet communication unit to the default settings.  
To use this function, the setting of the message monitor timer needs to be changed. For details, refer to page 5-3.

### Note:

To download the configuration parameters to Model KM1/KE1 units with the configurator, be sure to turn off the OUT executable flag.  
If the parameters are downloaded with the OUT executable flag in the ON state, the set value assigned through I/O communication and the set value downloaded with the configurator conflict and the set value assigned with I/O communication takes effect.

## ■ Setting of Description on DeviceNet Communication Unit

A name consisting of up to 32 characters (half-width character) can be given to each DeviceNet communication unit and recorded inside the unit.

Registered comments on DeviceNet communication units are displayed in the maintenance mode screen (refer to page 5-6), etc. by the configurator.

**Information** Comments on DeviceNet communication units are kept when the power is off.

### ● Setting method

- (1) Double click on the icon of the DeviceNet communication unit, select [Description Change], and enter a comment in the [Device Description Change] window.



**Information** After setting a comment, right click on the icon and select [Parameter] > [Download] to write the data into the DeviceNet communication unit.

## 5.3 Maintenance Mode Screen

### ■ What is Maintenance Mode Screen?

The maintenance mode screen is different from the normal screen, allowing you to easily monitor the network state and the state of each node.

The Network Configuration window of the maintenance mode screen allows you to be immediately informed of the occurrence of an error with the alarm displayed in yellow on the icon of the node where an error is detected.

### ● Setting method

The normal and maintenance screens can be switched in either of the following two ways.

- Switching by icon on the toolbar

(1) Clicking on the  icon on the toolbar of the configurator in the normal screen allows switching to the maintenance screen.

(2) Clicking on the  icon allows returning to the normal screen.



- Switching by operation from the [Display] menu

(1) Selecting [Display] > [Large Icon (Maintenance Mode)] on the menu bar allows displaying the maintenance mode screen.

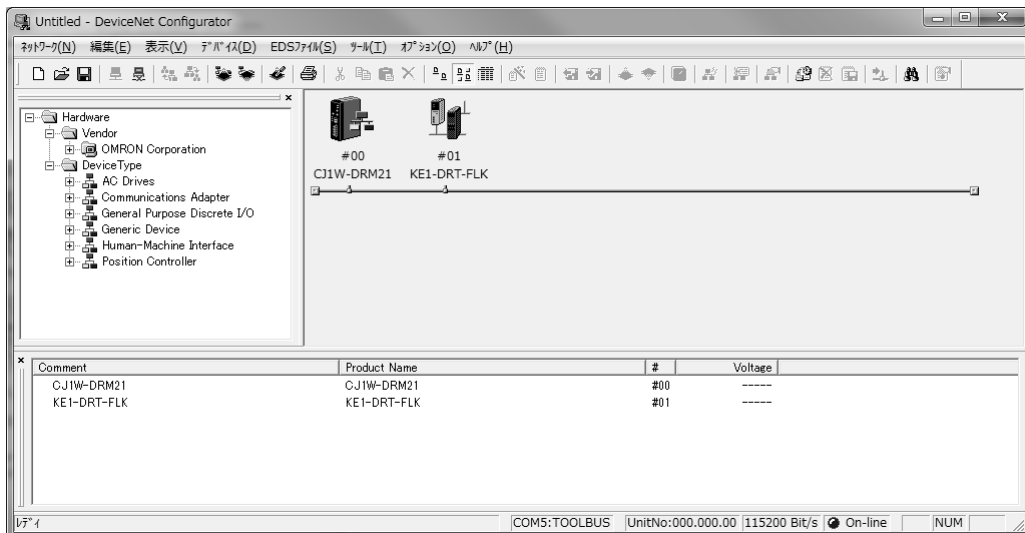
(2) Selecting [Display] > [Large Icon] on the menu bar allows displaying the normal screen.



### Information

-  This mark indicates a drop in network power supply.
-  This mark indicates that the maintenance flag is set.





# Chapter 6 Explicit Message Communication

6.1	Overview of Explicit Message Communication .....	6-2
■	What is Explicit Message Communication? .....	6-2
●	When variable data of Model KM1/KE1 are read/written or operation command is issued.....	6-2
■	Basic Format of Explicit Message .....	6-3
●	Command format.....	6-3
●	Response format .....	6-4
6.2	CompoWay/F Communication Command Destined for Model KM1/KE1 (Embedding of Explicit Message).....	6-6
■	Overview of Explicit Message Communication with Model KM1/KE1 Unit .....	6-6
●	Explicit message transmission from high-order device (PLC, PC) .....	6-6
●	Reception of Explicit message from Model KM1/KE1 .....	6-6
■	CompoWay/F ASCII Command.....	6-8
●	Command format.....	6-8
●	Response format .....	6-9
■	List of FINS-mini Commands.....	6-9

# 6.1 Overview of Explicit Message Communication

## ■ What is Explicit Message Communication?

The Explicit message communication allows a high-order device (PLC, PC) to issue a command as Explicit message and the node that receives the message to return the response to it.

- \* Issuing an Explicit message from the high-order device (PLC, PC) to the DeviceNet communication unit allows reading/writing data in the variable area of a Model KM1/KE1 unit, issuing an operation command, and reading/writing a variety of the functions supported by the DeviceNet communication unit.
- \* The Explicit message communication allows sending/receiving the data unable to be set as assignment data due to the lack of channels and the data that do not need to be updated as often as the data for remote I/O communication.

## ● When variable data of Model KM1/KE1 are read/written or operation command is issued

The high-order device (PLC, PC) issues a CompoWay/F communication command destined for a Model KM1/KE1 unit as data of Explicit message to the DeviceNet communication unit. The DeviceNet communication unit automatically converts the data into a CompoWay/F communication command and issues it to the Model KM1/KE1 unit. The DeviceNet communication unit converts the response from the Model KM1/KE1 unit into an Explicit message, and returns it to the high-order device (PLC, PC). This method is used when the data in the variable area of a Model KM1/KE1 unit is read/written or an operation command is issued.

- \* For details on the Explicit message communication with Model KM1/KE1 units, refer to "6.2 CompoWay/F Communication Command (Embedding of Explicit Message) Destined for Model KM1/KE1" (page 6-6).
- \* For information on the addresses used in Explicit message communication to read/write the data of the variable areas of Model KM1/KE1 units, refer to "4.1 List of Variable Areas" (page 4-2) in "Model KM1/KE1 Smart Electric Energy Monitor Smart Measurement Monitor Equipment Communication Manual" (SGTE-719).
- \* A CompoWay/F communication command allows sending up to 10 elements in Explicit message communication.

## ■ Basic Format of Explicit Message

The following describes the basic command and response formats of an Explicit message.

- \* For information on the command and response formats for the Explicit message communication with Model KM1/KE1, refer to page 6-6.

### ● Command format

Destination node address	Service Code	Class ID	Instance ID	Attribute ID	Data
-----------------------------	-----------------	----------	----------------	-----------------	------

- [Destination node address]  
The node address of the DeviceNet communication unit to which an Explicit message (command) is issued is specified as 1-byte (2-digit) hexadecimal number.
- [Service Code]、[Class ID]、[Instance ID]、[Attribute ID]  
These are parameters that specify command type, object to be processed, and details of processing.  
\* Depending on the command, Attribute ID may be unnecessary.
- [Data]  
This is used to specify the details of a command and enter a set value.  
For reading, data input in [Data] is unnecessary.

**Information** The number of digits used in [Class ID], [Instance ID], and [Attribute ID] may be different depending on the high-order device (PLC, PC). When a command is issued from a high-order device (PLC, PC) manufactured by Omron, follow the instructions below.

**Class ID** : 4 digits in hexadecimal notation (2 bytes)  
**Instance ID** : 4 digits in hexadecimal notation (2 bytes)  
**Attribute ID** : 2 digits in hexadecimal notation (1 byte)

## ● Response format

- When a normal response is returned to the issued Explicit message

Number of received bytes	Source node address	Service Code	Data
--------------------------	---------------------	--------------	------

- When an error response is returned to the issued Explicit message

Number of received bytes Fixed to 0004 Hex	Source node address	Service Code	Error code (Fixed to 2 bytes)
---	---------------------	--------------	----------------------------------

- [Number of received bytes]

The number of bytes of the portion after [Source node address] in the received data is returned in hexadecimal notation.

0004 Hex is always returned in an error response to an Explicit message.

- [Source node address]

The address of the node that issues a response is returned in hexadecimal notation.

- [Service Code]

Under normal conditions, the returned value is equivalent to the ON state of the highest-order bit (bit 7) of [Service Code] specified by the command. (When the Service Code of a command is 0E Hex, the Service Code of the response is 8E Hex.)

- [Data]

If a command for reading data is issued, read data is returned.

If a command does not carry out reading data, there is no data in [Data].

- [Error code]

The following table shows the error codes for Explicit messages.

Error code	Error name	Cause
08FF	Service not supported	Service code is not correct.
09FF	Invalid Attribute Value	The specified Attribute value is not supported. The written data is out of the data range.
0CFF	Object State Conflict	Communication error occurs between DeviceNet communication unit and Model KM1/KE1 unit. Another Explicit message is received during the processing of an Explicit message.
0EFF	Attribute Cannot Be Set	Service code for writing is issued to Attribute ID that only supports reading.
10FF	Device State Conflict	Model KM1/KE1 unit that does not exist is accessed. The EEPROM of DeviceNet communication unit is faulty.
13FF	Not Enough Data	Data size is shorter than the specified one.
14FF	Attribute Not Supported	The specified attribute is not supported.
15FF	Too Much Data	Data size is longer than the specified size.
16FF	Object Does Not Exist	The specified instance ID is not supported.
19FF	Store Operation Failure	The EEPROM of DeviceNet communication unit is faulty.

**Note:** Set the DeviceNet message monitor timer to 5 seconds or more in a DeviceNet communication unit. The setting procedure is shown below.

#### [DeviceNet unit for CS/CJ series]

- (1) Select [Connection] from the [Network] menu in the configurator to make the unit online.
- (2) Double click on the icon of the high-order device (PLC, PC) to display the [Device Parameter Edit] window, and select the [Message Monitor Timer] tab.
- (3) Select the DeviceNet communication unit and double click it. (In this example, the node address of the DeviceNet communication unit is 01.) In the [Message Monitor Timer Setting] dialog box, set 5000 ms and click on the [OK] button.



- (4) Click on the [General] tab in the [Device Parameter Edit] window and click on the [Download] button to start downloading. The value of the message monitor timer in the DeviceNet communication unit is changed.



#### [DeviceNet mater unit for SYSMAC α/CVM1/CV series]

Set response monitor time to 5000 ms in the [IOWR] order of Explicit message transmission. (The configurator does not allow setting message monitor timer.)

## 6.2 CompoWay/F Communication Command Destined for Model KM1/KE1 (Embedding of Explicit Message)

For communication with each Model KM1/KE1 unit in Explicit message communication, a CompoWay/F command is embedded into an Explicit message.

The following describes the format of Explicit message that has embedded CompoWay/F.

\* For details on CompoWay/F frame, refer to "Model KM1/KE1 Communication Manual" (SGTE-719).

### ■ Overview of Explicit Message Communication with Model KM1/KE1 Unit

The following describes how the DeviceNet communication unit operates when a high-order device (PLC, PC) sends it an Explicit message and when it receives an Explicit message from a Model KM1/KE1 unit.

\* For information on the flow from (1) to (5) described below, refer to "Fig. Overview of Explicit communication with Model KM1/KE1 Unit" (page 6-7) too.

#### ● Explicit message transmission from high-order device (PLC, PC)

- (1) The high-order device (PLC, PC) sends the DeviceNet communication unit a CompoWay/F command frame being embedded in the Explicit message command.
- (2) When receiving an Explicit message command, the DeviceNet communication unit extracts "Communication unit No." to "FINS-mini command text," adds "STX," "ETX," and "BCC" to create a CompoWay/F command frame, and sends it to a Model KM1/KE1 unit.
- (3) The Model KM1/KE1 unit returns the CompoWay/F response.

#### ● Reception of Explicit message from Model KM1/KE1

- (4) When receiving the CompoWay/F response sent from the Model KM1/KE1 unit, the DeviceNet communication unit deletes "STX," "ETX," and "BCC."
- (5) The DeviceNet communication unit converts the response into the hexadecimal data or ASCII format data. Then the unit converts the data into the Explicit message response and sends them to the high-order device (PLC, PC).  
(At this time, the DeviceNet communication unit performs "BCC" check.)

- (1) Send an Explicit message with CompoWay/F embedded.
- (2) Extract CompoWay/F and send it to Model KM1/KE1 unit.
- (3) Send response in the form of CompoWay/F from Model KM1/KE1 unit.
- (4) Delete unnecessary data from CompoWay/F response that is returned from Model KM1/KE1 unit.
- (5) Convert the data into the Explicit message response and send it to high-order device (PLC, PC).

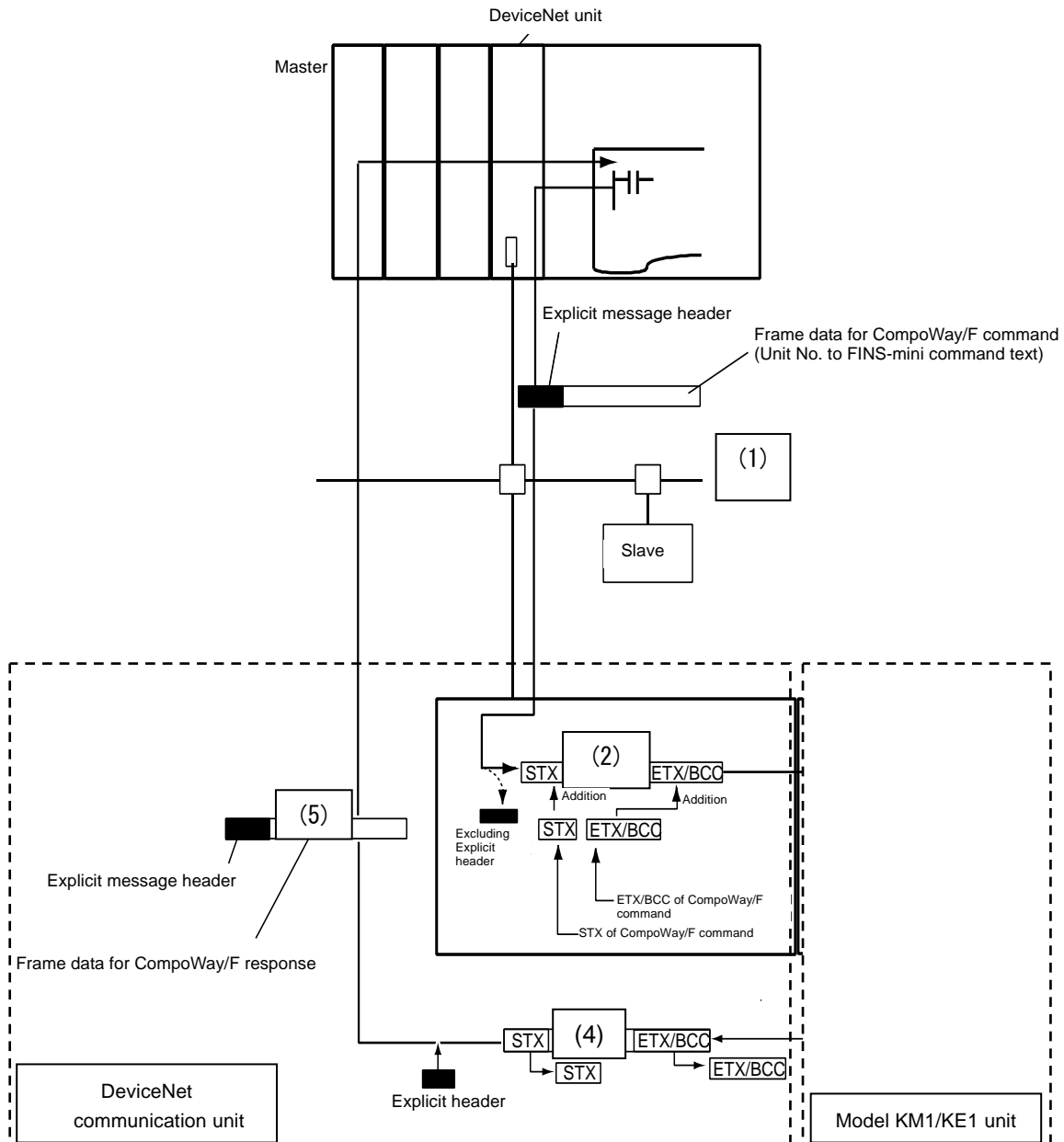

Fig. Overview of Explicit message communication with Model KM1/KE1 unit

## ■ CompoWay/F ASCII Command

The CompoWay/F ASCII command allows the portion of CompoWay/F frame to be written in ASCII codes. (When specifying a numerical value, convert the value of each digit into ASCII code one by one, e.g. "35 32" for the value "52.")

The CompoWay/F ASCII command is capable of using all CompoWay/F communication commands that can be used in Model KM1/KE1 units. (Unit attribute reading (0503) and broadcasting can be specified.)

The following shows the command and response formats used to issue an Explicit message from a high-order device (PLC, PC) manufactured by Omron.

### ● Command format

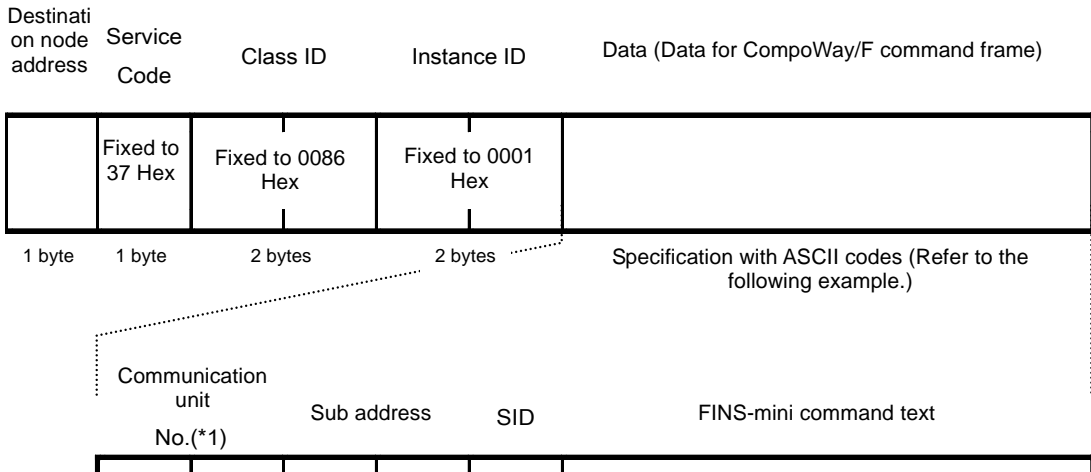

Service Code : 37 Hex (Fixed)  
 ClassID : 0086 Hex (Fixed)  
 InstanceID : 0001 Hex (Fixed)

\*1 When issuing a command for broadcasting, specify communication unit No. as "XX" (58 Hex 58 Hex in ASCII code).

Example: To allow the high-order device (PLC, PC) to read one element of voltage instantaneous value in Model KM1/KE1 unit No. 01, the CompoWay/F command frame data to be embedded into the Explicit message is as shown below.

· Unit No. : 01  
 · Reading of variable area : 0101  
 · Address of voltage instantaneous value : C0 0000  
 · Number of elements : 01

Unit No.		Sub address		SID	FINS-mini command text					
30Hex	31Hex	30Hex	30Hex	30Hex	30Hex	31Hex	30Hex	31Hex	43Hex	30Hex
FINS-mini command text										
30Hex	30Hex	30Hex	30Hex	30Hex	30Hex	30Hex	30Hex	30Hex	31Hex	



## ● Response format

- Under normal conditions

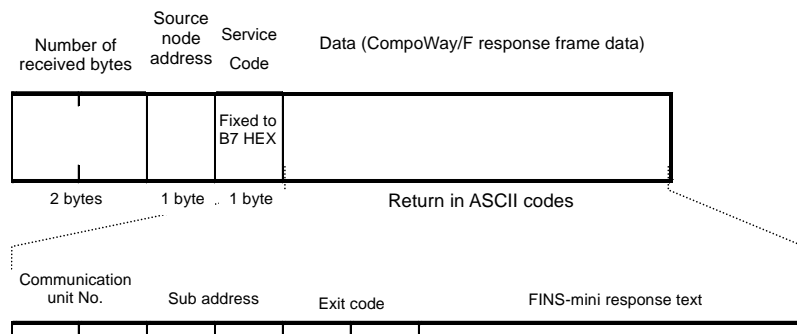

## ■ List of FINS-mini Commands

The following shows the list of FINS-mini commands that can be used for Model KM1/KE1 units. For details on the commands and variable areas, refer to "Model KM1/KE1 Communication Manual" (SGTE-719).

MRC	SRC	Service name	Processing	MRC and SRC description
				In the case of CompoWay/F ASCII command
01	01	Reading of data in variable area	Set values are read.	30Hex 31Hex 30Hex 31Hex
01	02	Writing of data into variable area	Set values are written.	30Hex 31Hex 30Hex 32Hex
05	03	Reading of unit attribute	Model and communication buffer size are read.	30Hex 35Hex 30Hex 33Hex
06	01	Reading of controller status	Operating state is read.	30Hex 36Hex 30Hex 31Hex
08	01	Echo back test	Echo back test is performed.	30Hex 38Hex 30Hex 31Hex
30	05	Operation command	Measurement and setting level transition and initialization are carried out.	33Hex 30Hex 30Hex 35Hex



# Chapter 7 Communication Capability

7.1	Remote I/O Communication Capability.....	7-2
	■ Input/Output Response Time.....	7-2
	● For CVM1/CV series (PLC under asynchronous processing operation mode).....	7-2
	● For CVM1/CV series (PLC under synchronous processing operation mode) .....	7-5
	● For CS/CJ series and for C200HX/HG/HE (-Z), C200H .....	7-7
	■ CompoWay/F Communication Cycle Time and Refresh Processing Time .....	7-9
	● Communication cycle time .....	7-9
	● Refresh processing time.....	7-10
	■ Network Having Multiple Masters Connected .....	7-11
	■ System Startup Time .....	7-12
	● Example of program .....	7-12
7.2	Capability of Message Communication.....	7-13
	■ Message Communication Time .....	7-13
	● Only message communication is executed (Remote I/O communication under suspension).....	7-13
	● Message communication is executed while message communication is in progress. ....	7-14

# 7.1 Remote I/O Communication Capability

The following describes the capability of remote I/O communication available when the master unit and slaves manufactured by Omron are used. Use the information when strict input/output timing is required.

The calculation described here is subject to the satisfaction of the following conditions.

- The mode in which the master unit operates must be the one where the scan list is nabled.
- All necessary slaves are connected to the network for the communication.
- Any error is not indicated on the master unit.
- There is not any message from a configurator manufactured by another company on the network.

**Information**

**If a master unit manufactured by another company is used or a slave(s) manufactured by another company is included, the calculation result may be different from the one shown here.**

## ■ Input/Output Response Time

The I/O response time is defined as the duration in which the input from an input slave is informed to the high-order device (PLC, PC), processed with the ladder program of the PLC, and output from the output slave.

### ● For CVM1/CV series (PLC under asynchronous processing operation mode)

- Minimum I/O response time

Minimum I/O response time is defined as the I/O response time available when the following condition is met; Immediately after an input is imported into the high-order device (PLC, PC), the DeviceNet unit is refreshed and the command is executed within 1 cycle time of the peripheral processing system.

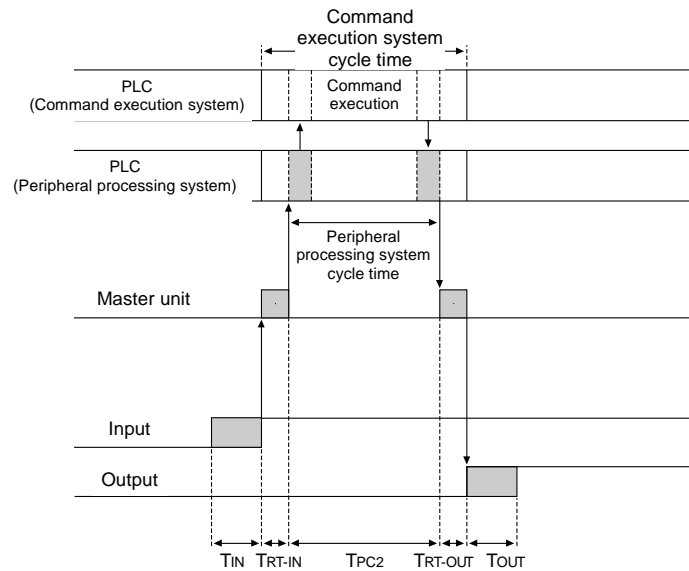

- TIN : Input slave ON (OFF) delay time ("0" is defined as minimum value.)  
 TOUT : Output slave ON (OFF) delay time ("0" is defined as minimum value.)  
 TRT-IN : Communication time of one input slave  
 TRT-OUT : Communication time of one output slave  
 TPC2 : Cycle time of peripheral processing system in PLC

**Information**

For information on the ON (OFF) delay time of each input or output slave, refer to the explanation on each slave. For information on the cycle time of the peripheral processing system in the PLC, refer to "■ CompoWay/F Communication Cycle Time and Refresh Processing Time" in Chapter 7.1 and the manual of the PLC in use.

The following formula allows obtaining minimum I/O response time (TMIN).

$$T_{MIN} = T_{IN} + TRT-IN + TPC2 + TRT-OUT + T_{OUT}$$

- Maximum I/O response time

Maximum I/O response time is defined as I/O response time available in the case shown in the diagram below.

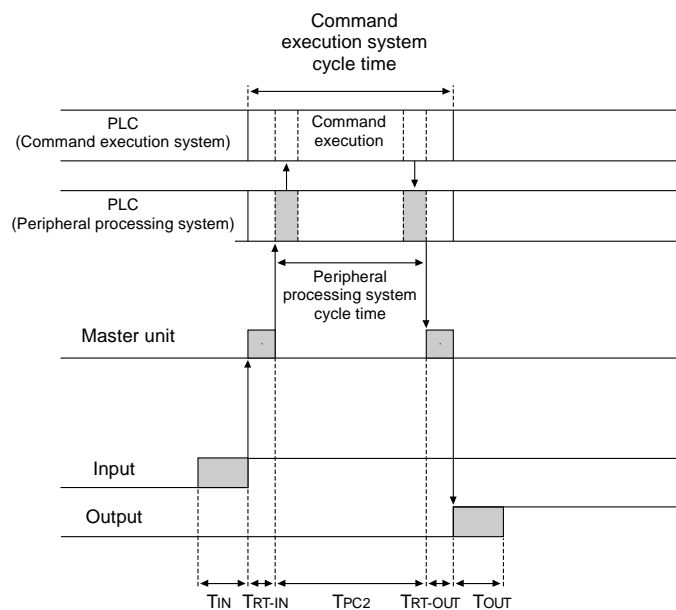

- TIN : Input slave ON (OFF) delay time  
 TOUT : Output slave ON (OFF) delay time  
 TRM : Communication cycle time of whole network (Refer to page 7-9.)  
 TPC1 : Cycle time of command execution system in PLC  
 TPC2 : Cycle time of peripheral processing system in PLC

**Information**

For information on the ON (OFF) delay time of each input or output slave, refer to the explanation on each slave. For information on the cycle times of the command execution and peripheral processing systems in the PLC, refer to "■ CompoWay/F Communication Cycle Time and Refresh Processing Time" in Chapter 7.1 and the manual of the PLC in use.

The following formula allows obtaining maximum I/O response time (TMAX).

$$T_{MAX} = T_{IN} + 2 \times TRM + TPC1 + 2 \times TPC2 + T_{OUT}$$

● For CVM1/CV series (PLC under synchronous processing operation mode)

· Minimum I/O response time

Minimum I/O response time is defined as I/O response time available in the case shown in the diagram below.

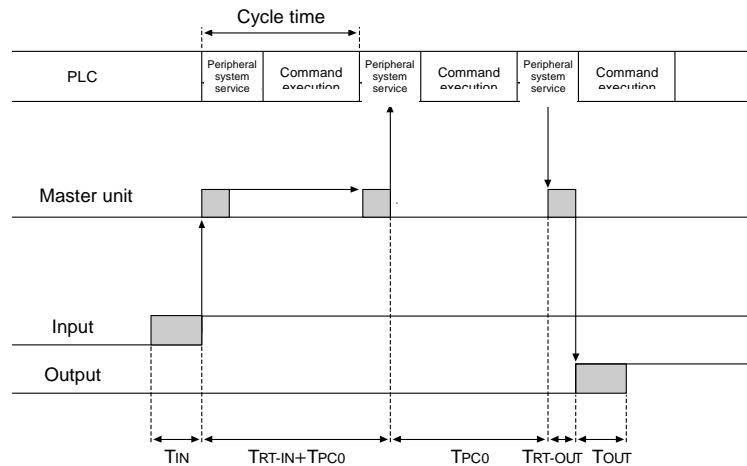

- TIN : Input slave ON (OFF) delay time ("0" is defined as minimum value.)  
 TOUT : Output slave ON (OFF) delay time ("0" is defined as minimum value.)  
 TRT-IN : Communication time of one input slave  
 TRT-OUT : Communication time of one output slave  
 TPC0 : Cycle time in PLC (Command execution + peripheral processing)

**Information**

For information on the ON (OFF) delay time of each input or output slave, refer to the explanation on each slave. For information on the cycle time in the PLC, refer to "■ CompoWay/F Communication Cycle Time and Refresh Processing Time" in Chapter 7.1 and the manual of the PLC in use.

The following formula allows obtaining minimum I/O response time (TMIN).

$$T_{MIN} = T_{IN} + TRT-IN + 2 \times TPC0 + TRT-OUT + TOUT$$

· Maximum I/O response time

Maximum I/O response time is defined as I/O response time available in the case shown in the diagram below.

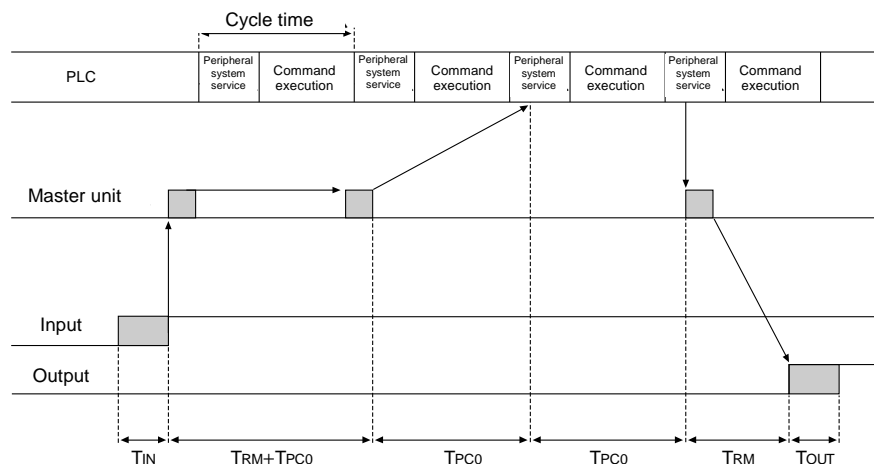

- TIN : Input slave ON (OFF) delay time
- TOUT : Output slave ON (OFF) delay time
- TRM : Communication cycle time of whole network (Refer to page 7-9.)
- TPC0 : Cycle time in PLC (Command execution + peripheral processing)



**Information**

For information on the ON (OFF) delay time of each input or output slave, refer to the explanation on each slave. For information on the cycle times of the command execution and peripheral processing systems in the PLC, refer to "■ CompoWay/F Communication Cycle Time and Refresh Processing Time" in Chapter 7.1 and the manual of the PLC in use.

The following formula allows obtaining maximum I/O response time (TMAX).

$$TMAX = TIN + 2 \times TRM + 3 \times TPC + TOUT$$

● For CS/CJ series and for C200HX/HG/HE (-Z), C200H

· Minimum I/O response time

Minimum I/O response time is defined as the I/O response time available when the following condition is met; Immediately after an input is imported into the high-order device (PLC, PC), the I/O of the slave is refreshed and the output to the slave is done at the beginning of the next I/O refresh.

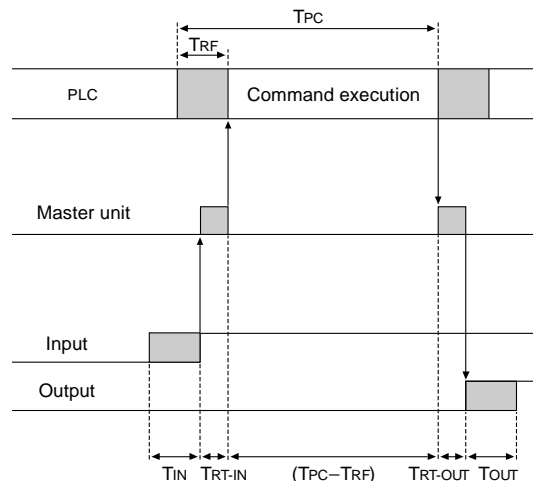

- TIN : Input slave ON (OFF) delay time ("0" is defined as minimum value.)  
 TOUT : Output slave ON (OFF) delay time ("0" is defined as minimum value.)  
 TRT-IN : Communication time of one input slave  
 TRT-OUT: Communication time of one output slave  
 TPC : Cycle time in PLC  
 TRF : DeviceNet unit refresh time in PLC

**Information**

For information on the ON (OFF) delay time of each input or output slave, refer to the explanation on each slave. For information on the cycle time in the PLC, refer to "■ CompoWay/F Communication Cycle Time and Refresh Processing Time" in Chapter 7.1 and the manual of the PLC in use.

The following formula allows obtaining minimum I/O response time (TMIN).

$$TMIN = TIN + TRT-IN + (TPC - TRF) + TRT-OUT + TOUT$$

· Maximum I/O response time

Maximum I/O response time is defined as I/O response time available in the case shown in the diagram below.

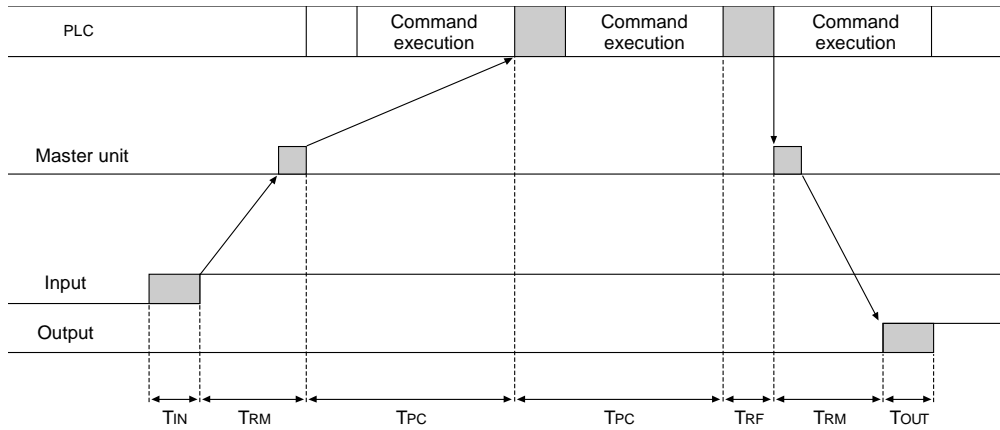

- TIN : Input slave ON (OFF) delay time
- TOUT : Output slave ON (OFF) delay time
- TRM : Communication cycle time of whole network
- TPC : Cycle time in PLC
- TRF : DeviceNet unit refresh time in PLC

**Information**

For information on the ON (OFF) delay time of each input or output slave, refer to the explanation on each slave. For information on the cycle time in the PLC, refer to "■ CompoWay/F Communication Cycle Time and Refresh Processing Time" in Chapter 7.1 and the manual of the PLC in use.

The following formula allows obtaining maximum I/O response time (TMAX).

$$TMAX = TIN + 2 \times TRM + 2 \times TPC + TRF + TOUT$$

## ■ CompoWay/F Communication Cycle Time and Refresh Processing Time

The following describes communication cycle time and refresh processing time necessary for the calculation of various processing times in DeviceNet.

### ● Communication cycle time

Communication cycle time is defined as the duration between the completion of processing I/O data for a slave and the start of processing the next one for the same slave.

The communication cycle time of the DeviceNet communication unit is the maximum value of "TIN" and "TOUT" in the CompoWay/F communication cycle time.

- Reference values for the communication cycle time

TIN : 80ms

TOUT : 5ms

**Note:**

**The above values are for reference and does not indicate the maximum values.**

**Communication cycle time depends on the number of connected DeviceNet communication units and the type and number of parameters assigned to I/O.**

## ● Refresh processing time

Refresh processing time is defined as the duration in which I/O information is exchanged between PLC (CPU unit) and DeviceNet master unit. Installing the master unit affects the cycle time of PLC as shown below.

### Information

**For details on refresh processing time and PLC cycle time, refer to the manual of the PLC in use.**

- In the case of the master unit for CVM1/CV series

Installing the master unit causes the following processing time to be added to the PLC cycle time (CPU high-functionality unit service).

Processing item	Processing time
CPU high-functionality unit service	DeviceNet unit refresh processing: 1.1 [ms]

- In the case of the master unit for CS/CJ series, C200HX/HG/HE (-Z), and C200H

Installing the master unit causes the following processing time to be added to the PLC cycle time (I/O refresh).

Processing item	Processing time
I/O refresh	DeviceNet unit I/O refresh processing: For CS/CJ and C200HX/HG/HE (-Z) $1.72 + 0.022 \times \text{Number of occupied channels} *1$ [ms] For C200HS $2.27 + 0.077 \times \text{Number of occupied channels} *1$ [ms]

- \*1: The number of occupied channels represents the number of channels in the I/O areas occupied by all slaves. The number of channels in the area where no node is connected is included when the number of occupied channels is counted.

For example, when only the slaves of node address 1 (IN 1 CH) and node address 5 (IN 1 CH) are connected, the number of occupied channels is 5 CH.

To obtain processing time in message communication, the number of channels for message communication is added to the number of occupied channels described above only when a message is processed.

## ■ Network Having Multiple Masters Connected

The following describes the communication cycle time (TRM) in a network having multiple masters connected.

Here is an example where two mater units are connected.

As shown below, divide nodes into two groups: nodes that conduct remote I/O communication with master A and nodes with master B.

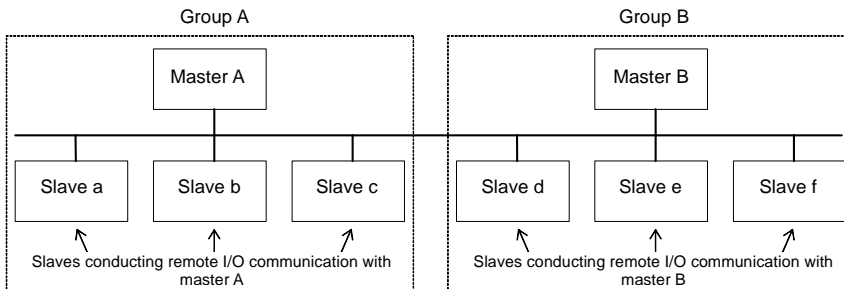

Note: As a matter of convenience, slaves are divided into two groups according to the master to which they are connected in the above diagram. However, this has no relation to the actual physical layout of slaves.

Referring to "■ CompoWay/F Communication Cycle Time and Refresh Processing Time" in Chapter 7.1, calculate each communication cycle time assuming that each group is in a different network.

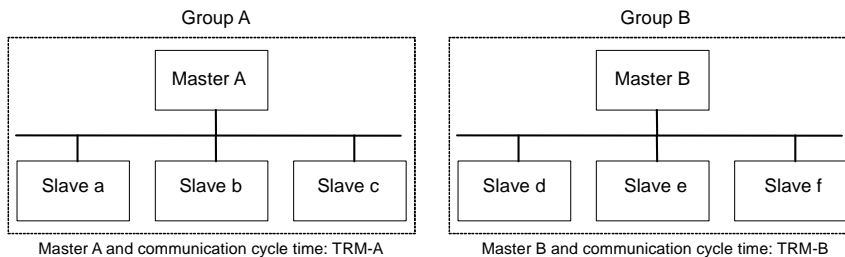

In a network having two masters connected, the communication cycle time of the entire network is as shown below.

$$TRM = TRM-A + TRM-B$$

The network having two masters connected is used as an example here. Similarly, calculate the communication cycle time of a network having multiple masters connected. Divide units into groups according to each remote I/O communication and calculate the communication cycle time of each group assuming that each group is an independent network. The total of the communication cycle times of all groups is the communication cycle time of the entire network.

## ■ System Startup Time

The following describes the system startup time defined as the duration between the turning on or restarting of a master and the starting of remote I/O control communication. (Under the scan list being enabled, remote I/O communication is automatically started.)

As shown below, startup time is different between when a master unit is started immediately after the power of all slaves are turned on and when only a master unit is restarted during communication.

Condition	LED indication on slave	System startup time
Immediately after starting slaves	NS LED is off or flashes in green.	11 seconds
Restarting of master only	NS LED flashes in red or green.	8 seconds
Restarting of slaves only	-	11 seconds

### ● Example of program

Communication cycle time is defined as the duration between the completion of processing I/O data for a slave and the completion of processing the next one for the same slave.

The communication cycle time in the DeviceNet communication unit is the maximum value of "TIN" and "TOUT" in the CompoWay/F communication cycle time.

- Reference values for the communication cycle time

The time described in the above is required for the DeviceNet system to be started. The following describes the example of a program that disables slaves to process I/O until a mater and remote I/O communication are started with the use of the master status area.

**Information**

**For details on the master status area, refer to the manual of each master unit.**

The conditions for the example of this program are shown below.

PLC : CS/CJ series PLC

Unit No. of master unit : 00

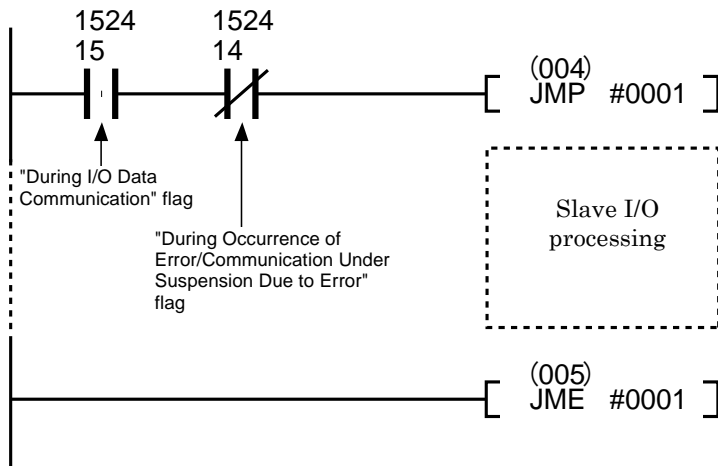

## 7.2 Capability of Message Communication

### ■ Message Communication Time

When a node issues a message (data for SEND/RECV instructions, FINS command for CMND and IOWR instructions) to another node, "Message communication time" is defined as the duration between the start of sending the network a message from the master unit and the end of sending the message.

**Note:** If PLC (CPU unit) executes (issues) another message before the passage of time shorter than the message communication time, or other message communication from the destination node to the source node is executed, the response message that the destination node is trying to send may be discarded or the message received by the destination node may be discarded. Accordingly, issue an instruction (SEND/RECV, CMND, and IOWR instructions) for message communication at intervals longer than the message communication time. In addition, make the message transmission interval to the same node longer than the message communication time.

If an error occurs and causes an outgoing or incoming message to be discarded, the corresponding error is recorded in the error history of the master unit. Read the error history in the master unit by issuing the FINS command or monitor the situation from the configurator.

To obtain the estimate of message communication time, use the following formula.

$$\text{Message communication time} = \text{Communication cycle time} \times \{(\text{Number of bytes of message} + 15) / 6 + 1\}$$

Number of bytes of message is defined as the number of bytes of the data that come after the command code in a FINS command. As shown below, communication cycle time depends on whether remote I/O communication is executed or not.

- Only message communication is executed (Remote I/O communication under suspension)

Communication cycle time = 2 Note + 0.11 x TB + 0.6 [ms]

When TB is 500 k bits/s = 2, 250 k bits/s = 4, 125 k bits/s = 8

(Depending on communication speed)

Note : When remote I/O communication is under suspension, communication cycle time is 2 ms.

- Message communication is executed while message communication is in progress.

Communication cycle time = (Communication cycle time when only remote I/O communication is executed)

$$+ 0.11 \times TB + 0.6 \text{ [ms]}$$

When TB is 500 k bits/s = 2, 250 k bits/s = 4, 125 k bits/s = 8

(Depending on communication speed)

**Note:**





































The message communication times described in the above can be used as a guide and do not indicate the maximum values. Message communication time depends on the factors such as frequency of message occurrence, load of the destination node, and communication cycle time. Note that message communication time may be longer than the one obtained in the above formula if a specific master unit is loaded.



# Chapter 8 Troubleshooting and Maintenance

8.1	Meaning of LED Indication and Troubleshooting .....	8-2
8.2	Maintenance of Equipment .....	8-3
■	Cleaning Method .....	8-3
■	Inspection Method .....	8-3
●	Things necessary for daily inspection .....	8-3
●	Things needed depending on the situation .....	8-3
●	Inspection items.....	8-4
■	Handling of Unit at Replacement .....	8-4
●	Note on unit replacement .....	8-4
●	Setting after unit replacement .....	8-5

# 8.1 Meaning of LED Indication and Troubleshooting

LED operation indicator				Probable cause	Action
PWR	CONN	ALM	COMM		
On 	On 	On 	On 	Immediately after turning on the power (All LED on)	-
				EEPROM data corruption (All LED on)	Repair is required. Contact the supplier of your product or our sales office.
On 	Flashing 	Off 	Off 	Slave ID duplication or out of the specified range	Check the ID setting.
				Unit no. duplication	Check unit nos.
				Master duplication	Check masters and slaves.
				Excess of max. number of units to be connected	Check the number of connected units.
				DIP switch protocol inconsistency	Check whether the setting is CompWay/F or Modbus. Make the setting consistent.
				Inconsistency between connection configuration and connected slave ID	Make the connection configuration and the connected slave ID consistent.
				Internal bus communication unavailable	Check the connection.
				Error in connected unit	Check the unit for abnormal condition.
On 	Off 	Off 	Off 	Normal startup (independently)	-
				During measurement (independently)	-
On 	On 	Off 	Off 	Normal startup (multiple units)	-
				During measurement (multiple units)	-
Flashing 	Off 	Off 	Off 	EEPROM error	If the problem remains after the power is turned off, repair is required. Contact the supplier of your product or our sales office.
				RAM error	
				RTC error	
Flashing 	Off 	Off 	Off 	Communication error	If the problem remains after the communication settings and wiring are checked, repair is required. Contact the supplier of your product or our sales office.
On 	On/off 	Off 	On 	During RS-485 or USB communication	-
On 	On/off 	On 	Off/flashing 	During alarm output	Refer to related manuals.
On 	On/off 	Flashing 	Off/flashing 	Current input limit exceeded	Ensure the input ratings.
				Voltage input limit exceeded	
				Frequency input error	

\*1. The above table shows errors that may occur in Model KM1/KE1 units. For errors on DeviceNet communication, refer to "■ Display" in Chapter 3.1.

\*2. The DeviceNet communication unit does not have LED for alarm indication.

## 8.2 Maintenance of Equipment

The following describes the daily maintenance of the equipment such as the cleaning and inspecting methods and the handling of units when they are replaced.

### ■ Cleaning Method

To use the network under optimum conditions, clean the equipment at regular intervals as shown below.

- Wipe with a dry soft cloth on a daily basis.
- If dirt cannot be removed with a dry cloth, dampen the cloth with a neutral detergent (2%), wring the wet cloth well, and wipe with it.
- Allowing rubber, vinyl product, or tape to adhere to a unit for long hours may cause stain on its surface. If there is stain on a unit surface, remove it at the time of cleaning.

**Note:**

**Never use volatile solvents such as benzene and thinner and chemical dustcloth. The unit coating may be deteriorated.**

### ■ Inspection Method

To keep the equipment under optimum conditions, perform regular inspection without fail. The equipment must be inspected once every 6 to 12 months. However, if the equipment is used under extremely high temperature and high humidity environment or dusty environment, shorten the inspection interval.

#### ● Things necessary for daily inspection

- Phillips-head screwdriver, flat-head screwdriver
- Screwdriver for communication connector
- Tester (or digital boltmeter)
- Industrial alcohol and genuine cotton cloth

#### ● Things needed depending on the situation

- Synchroscope
- Pen-writing oscilloscope
- Thermometer, hygrometer

### ● Inspection items

Inspect units to see whether the following items meet their criteria. If the criteria are not met, improve the ambient environment to meet the criteria or adjust the units.

Inspection item	Details of inspection	Criterion	Means for inspection
Environmental condition	Is ambient temperature and temperature inside the panel appropriate?	-10 to +55°C	Thermometer
	Is ambient humidity and humidity inside the panel appropriate?	25 to 85%	Hygrometer
	Has dust built up?	No dust	Visual inspection
Installation condition	Are units securely attached?	No looseness	Phillips-head screwdriver
	Are connectors of communication cables inserted completely?	No loose connection	Phillips-head screwdriver
	Are screws for external wiring loose?	No loose screw	Phillips-head screwdriver
	Is connection cable starting to be broken?	No abnormality in appearance	Visual inspection

### ■ Handling of Unit at Replacement

Each unit of DeviceNet is a component constituting a network system. If a unit fails, that may affect the entire network system. Immediately repair the faulty unit. To restore the network function with the least possible delay, we recommend keeping spare units for replacement.

### ● Note on unit replacement

When replacing a unit due to the finding of a defect, pay attention to the following points.

- After replacement, make sure that any error is not found in the new unit.
- When returning a defective unit for repair, attach a document that describes the details of the defect to the unit and send them to our branch or sales office listed at the end of this manual.
- In the case of contact failure, wipe the contact with a clean genuine cotton cloth dampened with industrial alcohol.

**Note:** Before replacing a unit, be sure to stop the network and turn off the power of all nodes to avoid electric shock.

- **Setting after unit replacement**

After replacing a unit, restore the same switch setting as the one before the unit is replaced. When replacing a Model KM1/KE1 unit connected to the DeviceNet communication unit, ensure the same configuration installing a unit of the same model.

**Information**

· **Backing up the configurations of the DeviceNet communication unit and individual Model KM1/KE1 units with the configurator allows their reconfigurations at once. For information on the upload and download of device parameters, refer to "DeviceNet Configuration Ver. 2 Operation Manual" (SBCD-316).**



# A Appendix

List of Models of Connection Related evices.....	A-2
■ DeviceNet Communication Unit.....	A-2
■ Model KM1/KE1 .....	A-2
■ DeviceNet Communication Cable and Connector with Cable.....	A-2
■ DeviceNet Communication Connector .....	A-3
■ Crimp-on Terminal for DeviceNet Communication Cable .....	A-3
■ Terminator.....	A-4
■ T-Branch Tap .....	A-4
● 1-branch tap .....	A-4
● 3-branch tap .....	A-4
■ Shield Type T-Branch Connector .....	A-4
■ 1-Branch Tap Dedicated for Power Supply .....	A-5
■ Inquiries on Product Manufactured by Other Company .....	A-6
Explanation of Technical Terms .....	A-7

# List of Models of Connection Related devices

## ■ DeviceNet Communication Unit

Model	Specification	Note
Model KE1-DRT-FLK	Model KE1 DeviceNet communication unit	Manufactured by Omron

## ■ Model KM1/KE1

Model	Specification			Note
	Unit name	Input	Output	
Model KM1-PMU1A-FLK	Power measurement unit	CT input: 3	Transistor output: 3	Manufactured by Omron
Model KM1-PMU2A-FLK	Two power systems measurement unit	CT input: 4	Transistor output: 3	Manufactured by Omron
Model KE1-PGR1C-FLK	Power/leakage monitor unit	CT input: 3 ZCT input: 1	Relay output: 1 Transistor output: 1	Manufactured by Omron
Model KE1-PVS1C-FLK	Power/voltage sag monitor unit	CT input: 3	Solid-state relay output: 1 Transistor output: 1	Manufactured by Omron

## ■ DeviceNet Communication Cable and Connector with Cable

Model	Specification	Note
Model DCA2-5C10	Thick cable, 5 conductors, 100 m	Manufactured by Omron
Model DCA1-5C10	Thin cable, 5 conductors, 100 m	Manufactured by Omron
DVN18-10G	Thick cable, 5 conductors, 10 m	Manufactured by Nihon Electric Wire & Cable *1
DVN18-30G	Thick cable, 5 conductors, 30 m	Manufactured by Nihon Electric Wire & Cable *1
DVN18-50G	Thick cable, 5 conductors, 50 m	Manufactured by Nihon Electric Wire & Cable *1
DVN18-100G	Thick cable, 5 conductors, 100 m	Manufactured by Nihon Electric Wire & Cable *1
DVN18-300G	Thick cable, 5 conductors, 300 m	Manufactured by Nihon Electric Wire & Cable *1
DVN18-500G	Thick cable, 5 conductors, 500 m	Manufactured by Nihon Electric Wire & Cable *1
DVN24-10G	Thin cable, 5 conductors, 10 m	Manufactured by Nihon Electric Wire & Cable *1
DVN24-30G	Thin cable, 5 conductors, 30 m	Manufactured by Nihon Electric Wire & Cable *1
DVN24-50G	Thin cable, 5 conductors, 50 m	Manufactured by Nihon Electric Wire & Cable *1
DVN24-100G	Thin cable, 5 conductors, 100 m	Manufactured by Nihon Electric Wire & Cable *1
DVN24-300G	Thin cable, 5 conductors, 300 m	Manufactured by Nihon Electric Wire & Cable *1



DVN24-500G	Thin cable, 5 conductors, 500 m	Manufactured by Nihon Electric Wire & Cable *1
1485C-P1-A50	Thick cable, 5 conductors, 50 m	Manufactured by Allen-Bradley *2
1485C-P1-C150	Thin cable, 5 conductors, 150 m	Manufactured by Allen-Bradley *2
Model DCA1-5CN□ □W1	Micro-size (M12) connector (plug: male, socket: female) shielded at both ends with thin cable Cable length: 0.5/1/2/3/5/10 m	Manufactured by Omron
Model DCA1-5CN□ □F1	Micro-size (M12) connector (socket: female) shielded at one end with thin cable Cable length: 0.5/1/2/3/5/10 m	Manufactured by Omron
Model DCA1-5CN□ □H1	Micro-size (M12) connector (plug: male) shielded at one end with thin cable Cable length: 0.5/1/2/3/5/10 m	Manufactured by Omron
Model DCA1-5CN□ □W5	Micro-size (M12) connector shielded at both ends with thin cable: female/mini-size: male connector Cable length: 1/2/5/10 m	Manufactured by Omron
Model DCA2-5CN□ □W1	Mini-size connector (plug: male, socket: female) shielded at both ends with thick cable Cable length: 1/2/5/10 m	Manufactured by Omron
Model DCA2-5CN□ □F1	Mini-size connector (socket: female) shielded at one end with thick cable Cable length: 1/2/5/10 m	Manufactured by Omron
Model DCA2-5CN□ □H1	Mini-size connector (plug: male) shielded at one end with thick cable Cable length: 1/2/5/10 m	Manufactured by Omron

\*1: The cables manufactured by Nihon Electric Wire & Cable are sold by Omron 24 Service. The specifications of the cables are same as the ones of the cables manufactured by Omron.

\*2: The cables manufactured by Allen-Bradley are harder than those manufactured by Omron and Nihon Electric Wire & Cable. Keep this point in mind when routing cables.

The manufacturers described below also sell DeviceNet communication cables. For details, refer to the product catalogues available in the homepage of ODVA Japan branch (<http://www.odva.astem.or.jp/>) or contact the following numbers.

**Nihon Electric Wire & Cable Co., Ltd**

10-1, 1-chome, Goryo, Daito-shi, Osaka 574-0064  
Sales Section, Sales Dept.  
Tel. 072-871-0364  
Fax. 072-871-0341  
URL <http://www.nihondensen.co.jp/>

**Kuramo Electric Co., Ltd.**

6F, Nakano Bldg. Nihonbashi, 13-10, 4-chome, Nihonbashi-honcho, Chuo-ku, Tokyo, 103-0023  
Tokyo Office, Kuramo Electric Co., Ltd.  
Tel. 03-5644-7601 (Main line)  
Fax. 03-5644-8231  
URL <http://www.kuramo.co.jp/>

**SWCC Showa Cable Systems Co., Ltd.**

1-18, 1-chome, Toranomom, Minato-ku, Tokyo 105-8444  
Wire Sales Section, Functional Device Sales Dept.  
Tel. 03-3597-7117  
Fax. 03-3597-7194  
URL <http://www.swcc.co.jp/>

**Sumitomo Wiring Systems, Ltd.**

25F, Nagoya Lucent Tower, 6-1, Ushijima-cho, Nishi-ku, Nagoya-shi, 451-6025  
Nagoya Office, Sumitomo Wiring Systems, Ltd.  
Tel. 052-582-6224  
Fax. 052-582-6227  
URL <http://www.sws.co.jp/>

**Dyden Corporation**

15-1, Minami 2-chome, Kurume-shi, Fukuoka 830-8511  
Kurume Office in Headquarters of Dyden Corporation  
Tel. 0942-22-1111  
Fax. 0942-51-2222  
URL <http://www.dyden.co.jp/>

## ■ DeviceNet Communication Connector

Model	Specification	Note
FCK2.5/5-STF-5.08AU	For node connection With or without screw for securing connector	Manufactured by Phoenix Contact

## ■ Crimp-on Terminal for DeviceNet Communication Cable

Model	Dedicated crimping tool	Specification	Note
AI series AI-0.5-8WH-B: For thin cable (Product No. 3201369)	Model ZA3	For insertion of 1 conductor	Manufactured by Phoenix Contact
AI series AI-TWIN2 x 0.5-8WH: For thin cable (Product No. 3200933)	UD6 (Product No. 1204436)	For insertion of 2 conductors (For multidrop connection)	

## ■ Terminator

Model	Specification	Note
Model DRS1-T	Terminal block type terminator, $121 \Omega \pm 1\%$ 1/4 W	Manufactured by Omron
Model DRS2-1	Micro-size (M12) connector (plug: male) with shield type terminator	
Model DRS2-2	Micro-size (M12) connector (socket: female) with shield type terminator	
Model DRS3-1	Mini-size connector (plug: male) with shield type terminator	

In addition to the above, using T-branch tap or 1-branch tap dedicated for power supply allows a terminator to be connected.

## ■ T-Branch Tap

### ● 1-branch tap

Model	Specification	Note
Model DCN1-1C	3 parallel-type connectors (Model XW4B-05C1-H1-D) with screw included (1 branch available) Connector inserting direction: Horizontal direction, Terminator attachment possible (Terminator element included as standard)	Manufactured by Omron
Model DCN1-2C	3 parallel-type connectors (Model XW4B-05C1-H1-D) with screw included (1 branch possible) Connector inserting direction: Vertical direction, Terminator attachment possible (Terminator element included as standard)	
Model DCN1-2R	3 orthogonal-type connectors (Model XW4B-05C1-VIR-D) with screw included (1 branch possible) Connector inserting direction: Vertical direction, terminator attachment possible (Terminator element included as standard)	

### ● 3-branch tap

Model	Specification	Note
Model DCN1-3C	5 parallel-type connectors (Model XW4B-05C1-H1-D) with screw included (3 branches available) Connector inserting direction: Horizontal direction, Terminator attachment possible (Terminator element included as standard)	Manufactured by Omron
Model DCN1-4C	5 parallel-type connectors (Model XW4B-05C1-H1-D) with screw included (3 branches available) Connector inserting direction: Vertical direction, Terminator attachment possible (Terminator element included as standard)	
Model DCN1-4R	5 orthogonal-type connectors (Model XW4B-05C1-H1-D) with screw included (3 branches available) Connector inserting direction: Vertical direction, Terminator attachment possible (Terminator element included as standard)	

## ■ Shield Type T-Branch Connector

Model	Specification	Note
Model DCN2-1	Shield type T-branch connector (1 branch) Micro-size (M12) connector x 3 types	Manufactured by Omron
Model DCN3-11	Shield type T-branch connector (1 branch), mini-size connector x 3 types	
Model DCN3-12	Shield type T-branch connector (1 branch), Mini-size connector x 2 + micro-size (M12) connector x 1 type	

## ■ 1-Branch Tap Dedicated for Power Supply

Model	Specification	Note
Model DCN1-1P	1-branch tap dedicated for power supply Used for connection to communication power supply 2 parallel-type connectors (Model XW4B-05C1-H1-D) with screw, 2 fuses included as standard Terminator attachment possible (Terminator element included as standard)	Manufactured by Omron

## ■ Inquiries on Product Manufactured by Other Company

### Rockwell Automation Japan (Products of Allen-Bradley)

Shinkawa Miyuki Bldg., 1-3-17, Shinkawa, Chuo-ku, Tokyo, 104-0033

Product and Marketing Dept., Head Office

Tel. 03-3206-2783

Fax. 03-3206-2788

URL <http://www.automation.rockwell.co.jp/>

### Phoenix Contact

6F, Yuusen Shinyokohama 1-chome Bldg., 1-7-9, Shinyokohama, Minato

Kita-ku, Yokohama-shi, Kanagawa, 222-0033

Tel. 045-471-0030(代)

Fax. 045-471-0031

URL <http://www.phoenixcontact.co.jp/>

# Explanation of Technical Terms

Term	Description
Busoff	Indicates that error occurrence rate on the communication cable is extremely high. When the internal error counter value exceeds a given threshold, an error is detected. (The internal error counter is reset when a master unit is started or restarted.)
CAN	Acronym of Controller Area Network. This is a communication protocol developed as LAN within a vehicle. DeviceNet uses CAN technology.
Configurator	Device used for system configuration. This device has the functions of reading ID information, reading/writing parameters, and displaying network configuration. DeviceNet Configurator and CX-Integrator are available as configurator for the master units manufactured by Omron.
Consumed Connection Size	Indicates the size (byte length) of the data received through a connection.
ODVA	Acronym of Open DeviceNet Vendor Association. Nonprofit vendor association established for the promotion of DeviceNet.
Produced Connection Size	Indicates the size (byte length) of the data sent through a connection.
Connection	Logical communication channel for the communication between nodes. Connections between masters and slaves are maintained and managed.
Master/slave	Master is defined as a node that manages the collection and distribution of data. Slave is defined as a node that returns a response in accordance with the request from the master. In the DeviceNet system made by Omron, all products provide the master or slave function with the form of Predefined Master/Slave Connection Set.
Measurement master	A type of unit classified in Model KM1/KE1 series This unit can function independently. The unit can also function, interconnecting with functional, CT extension, and communication slaves.
Functional slave	A type of unit classified in Model KM1/KE1 series This unit can function independently. The unit can be connected to the measurement unit only.
CT expansion slave	A type of unit classified in Model KM1/KE1 series This unit can function, being connected to the measurement unit. This unit allows measurement in multiple circuits.
Communication slave	A type of unit classified in Model KM1/KE1 series This unit can function, being connected to the measurement unit. This unit allows DeviceNet communication.



# Index

## A

- Area configuration in simple assignment ..... 4-7
- Assignment of assignment data to high-order device ..... 4-9,4-15
- Assignment procedure..... 4-5
- Automatic detection of communication speed 1-2

## C

- Capability of message communication ..... 7-11
- Cleaning method ..... 8-3
- [Compare] button ..... 4-11
- CompoWay/F ASCII command..... 6-3,6-8
- CompoWay/F communication command..... 6-3
- Configuration switch ..... 3-5
- Connection ..... 4-10
- Command format..... 6-4,6-8
- Communication cable ..... A-2
- Communication connector..... A-3
- Communication cycle time..... 7-7
- Communication distance ..... 1-6
- Communication specifications ..... 1-6
- Connection settings ..... 4-17
- Connection specifications ..... 1-7
- Connection to DeviceNet communication unit 3-12
- Connector ..... 3-7
- Crimp-on terminal ..... A-3
- CX-Integrator ..... 5-2,A-6
- CX-Programmer ..... 1-2
- Cyclic ..... 4-17

## D

- Dividing IN area into two ..... 4-17
- Download button..... 4-11

## E

- Explicit message communication..... 1-2, 1-4, 6-2
- External dimensions (mm) ..... 3-3

## F

- FINS-mini command ..... 6-9

## G

- General specifications ..... 1-7

## H

- Handling of unit at replacement ..... 8-4

## I

- IN area ..... 4-5,4-7,4-8,4-10
- Inspection method ..... 8-3
- Installation of DeviceNet communication unit and installation on DIN rail ..... 3-8
- I/O assignment with configurator ..... 1-6,2-4,4-10
- I/O response time ..... 7-2

## L

- Lateral connection hook ..... 3-6
- LED display..... 8-2
- List of assignment options ..... 4-13
- List of models of connected devices..... A-2

## M

- Maintenance mode screen ..... 5-6
- Manual assignment ..... 3-5
- Manual assignment by setting from configurator ..... 4-4
- Max. number of connected units ..... 1-7
- Measurement master to be connected ..... 1-7
- Message communication time ..... 7-11
- Method for creating assignment data ..... 4-10

- Model KM1/KE1 unit ..... 3-6
- Model KM1/KE1 unit settings/monitor/operation from configurator..... 1-2
- Module status ..... 3-4

## N

- Name of each part ..... 3-2
- Network status ..... 3-4
- Node address setting..... 3-5

## O

- OUT area ..... 4-5
- Overview of assignment method ..... 4-2

## P

- Poll ..... 4-17
- Preparation of DeviceNet communication cable ..... 3-10

## R

- Rated power supply voltage ..... 1-7
- Refresh processing time ..... 7-8
- Remote I/O communication ..... 1-2,1-3,1-6,4-2
- Reset button ..... 5-4
- Response format ..... 6-5,6-8
- Restore Default button..... 5-4

## S

- Setting of description on DeviceNet communication unit..... 5-5
- Setup procedure ..... 2-2
- Simple assignment ..... 1-2,1-6,2-3,3-5
- Simple assignment with switch setting ..... 3-3
- Slave ID ..... 1-8
- Slave setting ..... 4-5
- Slaves that can be connected to measurement master ..... 1-7
- Soft reset ..... 1-3
- Switch settings..... 3-5
- System configuration ..... 1-5
- System startup time ..... 7-10

## T

- Terminal layout..... 3-3
- Transfer/Monitor from configurator ..... 1-6
- Types of Model KM1/KE1 units..... 1-8

## U

- Upload button ..... 4-11

## W

- Wiring for Model KM1/KE1 units..... 3-13







**OMRON Corporation Industrial Automation Company**  
Tokyo, JAPAN

Contact: [www.ia.omron.com](http://www.ia.omron.com)

**Regional Headquarters**

**OMRON EUROPE B.V.**

Wegalaan 67-69-2132 JD Hoofddorp  
The Netherlands  
Tel: (31)2356-81-300/Fax: (31)2356-81-388

**OMRON ELECTRONICS LLC**

One Commerce Drive Schaumburg,  
IL 60173-5302 U.S.A.  
Tel: (1) 847-843-7900/Fax: (1) 847-843-7787

**OMRON ASIA PACIFIC PTE. LTD.**

No. 438A Alexandra Road # 05-05/08 (Lobby 2),  
Alexandra Technopark,  
Singapore 119967  
Tel: (65) 6835-3011/Fax: (65) 6835-2711

**OMRON (CHINA) CO., LTD.**

Room 2211, Bank of China Tower,  
200 Yin Cheng Zhong Road,  
PuDong New Area, Shanghai, 200120, China  
Tel: (86) 21-5037-2222/Fax: (86) 21-5037-2200

Authorized Distributor:

© OMRON Corporation 2012 All Rights Reserved.  
In the interest of product improvement,  
specifications are subject to change without notice.

Cat. No. N177-E1-01

Printed in Japan