

Voltage Sensor LG2

CSM_LG2_DS_E_4_3

Compact, Economical Plug-in Type Voltage Sensing Relay

- DPDT output contacts expand the application of the Sensor to wide-ranging fields including control, alarms, and indication.
- Voltage control is possible in the same easy manner as electro-magnetic relays, as the output relay of the sensor can be driven directly with a detection signal.
- Wide voltage setting range with fine setting capability.



Model Number Structure

■ Model Number Legend

LG2-□□

1 2 3

1. Voltage sensor

2, 3. Operating Voltage

AB: 100, 110, 200 VAC

DB: 12, 24, 48, 100 VDC

Ordering Information

■ List of Models

Detected voltage	Model
AC	LG2-AB (100 VAC) LG2-AB (200 VAC) LG2-AB (110 VAC)
DC	LG2-DB (12 VDC) LG2-DB (24 VDC) LG2-DB (48 VDC) LG2-DB (100 VDC)

■ Connecting Socket

Socket		Bracket
Type	Model	Model
Front-mounting socket	PF083A	PFC-A7
Back-mounting socket	PL08	PLC-8

Note: Use the above sockets to mount the Voltage Sensor securely and prevent problems, such as faulty contact.

Specifications

■ Ratings

Item	Detected voltage	Load	Setting range		Rated carry current	Control output			
	Rated voltage		Power/VA consumption	Must-operate (SET) voltage (percentage of rated value)		Must-release (RESET) voltage (percentage of rated value)	Switching capacity		
							Rated operating voltage	Rated operating current	
Model						Resistive load (cosφ = 1)		Inductive load (cosφ = 0.4, L/R = 7 ms)	
LG2-AB	100 VAC 200 VAC 50/60 Hz	5 VA max.	75% to 120%	70% to 115%	5 A	100 VAC 200 VAC 28 VDC 110 VDC	5 A 2 A 5 A 0.2 A	3 A 1.2 A 2 A 0.1 A	
	110 VAC 50/60 Hz		80% to 110%	75% to 105%					
LG2-DB	12 VDC 24 VDC 48 VDC 100 VDC	3 W max.	75% to 120%	70% to 115%					

- Note:**
1. Set the must-operate voltage higher than the must-release voltage by at least 5% of the rated value.
 2. Smoothing is required for the detected DC voltage.
 3. The maximum applied voltage is 120% of the rated value.
 4. Special models enabling a rated voltage of 220 V are available. The setting range for these models is 80% to 110%.

■ Characteristics

Repeat accuracy	±3% max. (with voltage fluctuations at the rate of 1 V/s)
Variation due to temperature change	±5% max. (within the range 20 °C +20/-30 °C)
Operate time	0.5 s max. (when input changes from 0 V to 120% must-operate voltage)
Release time	0.5 s max. (when input changes from 120% of the must-release voltage to 0 V)
Insulation resistance	10 MΩ min. at 500 VDC (between electric circuitry and mounting panel)
Dielectric strength	2,000 VAC, 50/60 Hz for 1 min (between electric circuitry and mounting panel)
Vibration	Malfunction: 16.7 Hz, 1-mm double amplitude
Shock	Destruction: 294 m/s ² (approx. 30 G)
Service life	Mechanically: 10,000,000 operations min. Electrically: 50,000 operations min. (at max. applicable load)
Weight	Approx. 100 g
Ambient operating temperature	-10 to 40°C (with no condensation)

Connections

Terminal Arrangement

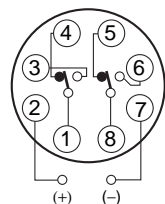

The polarity indication for terminals ② and ⑦ applies to the DC model (LG2-DB).
(The above diagram shows the rear side of the Relay.)

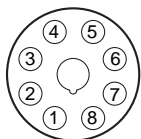

(The above diagram shows the rear side of the Relay.)

- Note:**
- *Type LG2-DB is not equipped with the rectifier circuit.
 - With type LG2-DB, care should be taken to the polarity of the power supply.

Nomenclature

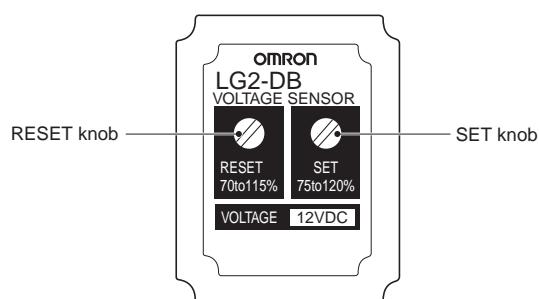

Setting Method

Operate Value

Input the actual voltage to be set, and set the SET knob to the point at which the Relay operates.

Release Value

- With the Relay operating, turn the RESET knob counterclockwise as far as it will go, and adjust the voltage to the value to be set. Then, gradually turn the RESET knob clockwise until it reaches the point where the Relay is released.

Note: After completing the settings, check the settings for the operate and release values by increasing/decreasing the input voltage.

- The LG2 can be used for undervoltage detection by using the RESET knob for the operate value and the SET knob for the release value. The Relay will normally be ON, however, and so the internal temperature will rise, and this will affect the product service life.

Dimensions

Note: All units are in millimeters unless otherwise indicated.

LG2-AB, LG2-DB

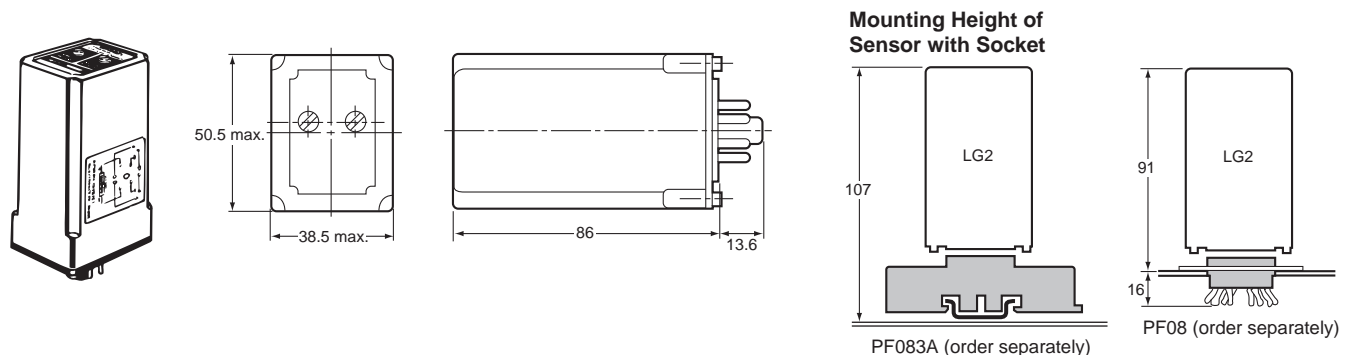

Accessories (Order Separately)

Connecting Socket

PF083A Front Connecting Socket

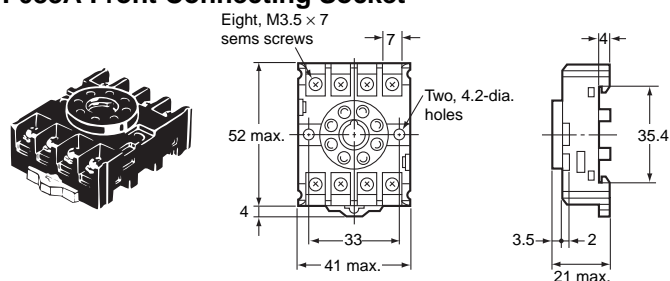

Terminal Arrangement

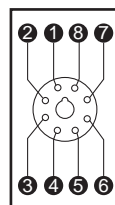

(Top View)

Mounting Holes

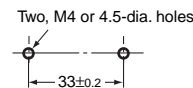

Note: Mount sockets to applicable models so that points downwards.

Applicable Models
APR-S
LG2

PL08 Back Connecting Socket (Solder Terminals)

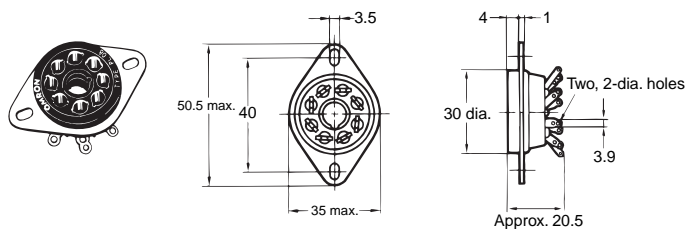

Terminal Arrangement

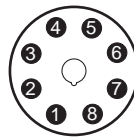

(Top View)

Mounting Holes

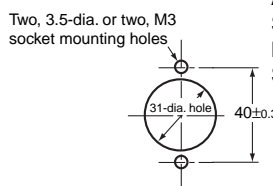

Applicable Models
SE
APR-S
SDV
LG2
SAO

Socket Mounting Track (for PF083A)

PFP-100N/PFP-50N Socket Mounting Track

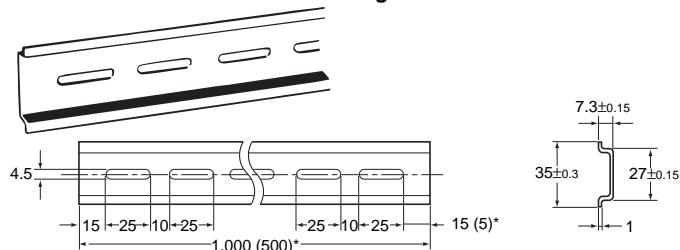

* The dimensions given in parentheses are for the PFP-50N Socket Mounting Track.

Hold-down Clip

Use the Hold-down Clip to secure the Voltage Sensor on the Connecting Socket, as well as to prevent faulty contact.

Type of Socket	Applicable type of Hold-down Clip
PF083A	PFC-A7
PL08	PLC-8

ALL DIMENSIONS SHOWN ARE IN MILLIMETERS.
To convert millimeters into inches, multiply by 0.03937. To convert grams into ounces, multiply by 0.03527.

In the interest of product improvement, specifications are subject to change without notice.

Terms and Conditions Agreement

Read and understand this catalog.

Please read and understand this catalog before purchasing the products. Please consult your OMRON representative if you have any questions or comments.

Warranties.

(a) Exclusive Warranty. Omron's exclusive warranty is that the Products will be free from defects in materials and workmanship for a period of twelve months from the date of sale by Omron (or such other period expressed in writing by Omron). Omron disclaims all other warranties, express or implied.

(b) Limitations. OMRON MAKES NO WARRANTY OR REPRESENTATION, EXPRESS OR IMPLIED, ABOUT NON-INFRINGEMENT, MERCHANTABILITY OR FITNESS FOR A PARTICULAR PURPOSE OF THE PRODUCTS. BUYER ACKNOWLEDGES THAT IT ALONE HAS DETERMINED THAT THE PRODUCTS WILL SUITABLY MEET THE REQUIREMENTS OF THEIR INTENDED USE.

Omron further disclaims all warranties and responsibility of any type for claims or expenses based on infringement by the Products or otherwise of any intellectual property right. (c) Buyer Remedy. Omron's sole obligation hereunder shall be, at Omron's election, to (i) replace (in the form originally shipped with Buyer responsible for labor charges for removal or replacement thereof) the non-complying Product, (ii) repair the non-complying Product, or (iii) repay or credit Buyer an amount equal to the purchase price of the non-complying Product; provided that in no event shall Omron be responsible for warranty, repair, indemnity or any other claims or expenses regarding the Products unless Omron's analysis confirms that the Products were properly handled, stored, installed and maintained and not subject to contamination, abuse, misuse or inappropriate modification. Return of any Products by Buyer must be approved in writing by Omron before shipment. Omron Companies shall not be liable for the suitability or unsuitability or the results from the use of Products in combination with any electrical or electronic components, circuits, system assemblies or any other materials or substances or environments. Any advice, recommendations or information given orally or in writing, are not to be construed as an amendment or addition to the above warranty.

See <http://www.omron.com/global/> or contact your Omron representative for published information.

Limitation on Liability: Etc.

OMRON COMPANIES SHALL NOT BE LIABLE FOR SPECIAL, INDIRECT, INCIDENTAL, OR CONSEQUENTIAL DAMAGES, LOSS OF PROFITS OR PRODUCTION OR COMMERCIAL LOSS IN ANY WAY CONNECTED WITH THE PRODUCTS, WHETHER SUCH CLAIM IS BASED IN CONTRACT, WARRANTY, NEGLIGENCE OR STRICT LIABILITY.

Further, in no event shall liability of Omron Companies exceed the individual price of the Product on which liability is asserted.

Suitability of Use.

Omron Companies shall not be responsible for conformity with any standards, codes or regulations which apply to the combination of the Product in the Buyer's application or use of the Product. At Buyer's request, Omron will provide applicable third party certification documents identifying ratings and limitations of use which apply to the Product. This information by itself is not sufficient for a complete determination of the suitability of the Product in combination with the end product, machine, system, or other application or use. Buyer shall be solely responsible for determining appropriateness of the particular Product with respect to Buyer's application, product or system. Buyer shall take application responsibility in all cases.

NEVER USE THE PRODUCT FOR AN APPLICATION INVOLVING SERIOUS RISK TO LIFE OR PROPERTY OR IN LARGE QUANTITIES WITHOUT ENSURING THAT THE SYSTEM AS A WHOLE HAS BEEN DESIGNED TO ADDRESS THE RISKS, AND THAT THE OMRON PRODUCT(S) IS PROPERLY RATED AND INSTALLED FOR THE INTENDED USE WITHIN THE OVERALL EQUIPMENT OR SYSTEM.

Programmable Products.

Omron Companies shall not be responsible for the user's programming of a programmable Product, or any consequence thereof.

Performance Data.

Data presented in Omron Company websites, catalogs and other materials is provided as a guide for the user in determining suitability and does not constitute a warranty. It may represent the result of Omron's test conditions, and the user must correlate it to actual application requirements. Actual performance is subject to the Omron's Warranty and Limitations of Liability.

Change in Specifications.

Product specifications and accessories may be changed at any time based on improvements and other reasons. It is our practice to change part numbers when published ratings or features are changed, or when significant construction changes are made. However, some specifications of the Product may be changed without any notice. When in doubt, special part numbers may be assigned to fix or establish key specifications for your application. Please consult with your Omron's representative at any time to confirm actual specifications of purchased Product.

Errors and Omissions.

Information presented by Omron Companies has been checked and is believed to be accurate; however, no responsibility is assumed for clerical, typographical or proofreading errors or omissions.

2023.7

In the interest of product improvement, specifications are subject to change without notice.

OMRON Corporation
Industrial Automation Company

<http://www.ia.omron.com/>

(c)Copyright OMRON Corporation 2023 All Right Reserved.