

Safety Controller

G9SX Series

Logical AND Function Adds Flexibility to Various Safety Circuits



Be sure to read the *Safety Precautions* on page 45.

For the most recent information on models that have been certified for safety standards, refer to your OMRON website.

G9SX Series Function LIST

Specifications		Model	G9SX-BC202	G9SX-AD322-T15 G9SX-AD322-T150	G9SX-ADA222-T15 G9SX-ADA222-T150	G9SX-GS226-T15	G9SX-SM032	G9SX-NS202	G9SX-NSA222-T03
		Basic Unit	Advanced Unit	Advanced Unit	Safety Guard Switching Unit	Standstill Monitoring Unit	Non-Contact Door Switch Controller	Non-Contact Door Switch Controller	
Logical and connection	Inputs	---	1 (Semi-conductor)	2 (Semi-conductor)	1 (Semi-conductor)	---	1 (Semi-conductor)	1 (Semi-conductor)	
	Outputs	2 (Semi-conductor)	1 (Semi-conductor)	2 (Semi-conductor)	1 (Semi-conductor)	---	1 (Semi-conductor)	1 (Semi-conductor)	
Safety input device	Emergency Stop Switches	○	○	○	---	---	---	○	
	Safety Door Switches	○	○	○	○	---	---	○	
	Non-Contact Door Switches (D40A/D40Z)	---	---	---	---	---	○	○	
	Safety Light Curtains	○	○	○	○	---	---	---	
	Motor (single-phase / three-phase)	---	---	---	---	○	---	---	
Number of safety input devices connected		1	1	1	2 (Switching)	1	1	1	
No. of input channels		1 or 2 channels	1 or 2 channels	1 or 2 channels	1 or 2 channels	---	1 channels	2 channels	
Safety outputs	Instantaneous	2 (Semi-conductor)	3 (Semi-conductor)	2 (Semi-conductor)	2 (Semi-conductor)	---	2 (Semi-conductor)	2 (Semi-conductor)	
	OFF-delayed	---	2 (Semi-conductor)	2 (Semi-conductor)	2 (Semi-conductor)	---	---	2 (Semi-conductor)	
	Max.OFF-delay time *1	---	15 s/150 s	15 s/150 s	15 s	30 s (Judgment time of stop)	---	3 s	
	Safety standstill detection output	---	---	---	---	3 (Semi-conductor)	---	---	
	Connection of expansion unit	---	○	○	○	---	---	○	
Auxiliary outputs		2 (Semi-conductor)	2 (Semi-conductor)	2 (Semi-conductor)	6 (Semi-conductor) *2	2 (Semi-conductor)	2 (Semi-conductor)	2 (Semi-conductor)	
Guard Switching		---	---	---	○	---	---	---	

Specifications		Model	G9SX-EX401	G9SX-EX041
		Expansion Unit	Expansion Unit	
Safety outputs	Instantaneous	4 PST-NO	---	
	OFF-delayed	---	4 PST-NO	
	Max. OFF-delay time	---	*3	
Auxiliary outputs		1 (Semi-conductor)	1 (Semi-conductor)	

*1. The OFF-delayed output becomes an instantaneous output by setting the OFF-delay time to 0 s. (Excluding G9SX-SM).

*2. Including external indicator output (UA/UB).

*3. The OFF-delay time is synchronized to the OFF-delay time setting in the connected Advanced Unit (G9SX-AD-□/G9SX-ADA-□).

G9SX Series

Flexible Safety Unit (Advanced Unit/Basic Unit/Expansion Unit)

G9SX-AD□/BC/EX

Logical AND Function Adds Flexibility to I/O Expansion

- Facilitates partial or complete control system setup.
- Solid-state outputs (excluding Expansion Units).
- Detailed LED indications enable easy diagnosis.
- TÜV SÜD certification for compliance with IEC/EN61508 (SIL3), EN ISO13849-1 (PLe/Safety Category 4).
- Approved by UL and CSA.



Be sure to read the *Safety Precautions* on page 45.



For the most recent information on models that have been certified for safety standards, refer to your OMRON website.

Application Examples

Parts Processing Machine

- The entire device stops when the emergency stop switch is pressed.
- Only the processing section stops when the Safety Light Curtain is interrupted.

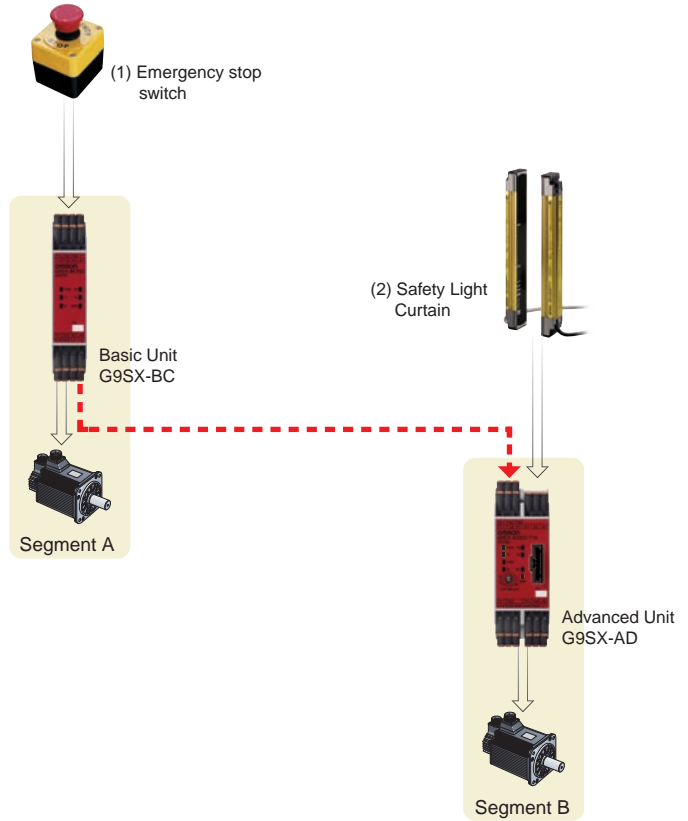
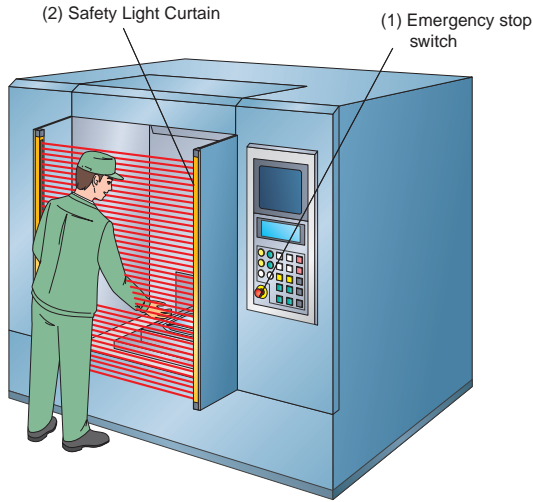

Operating Example

- (1) The emergency stop switch is pressed.
- (2) Safety Light Curtain is interrupted.



Machining Center

- When the Emergency Stop Switch is pressed, the entire machine will stop.
- When a door is open, the corresponding part will not be activated.

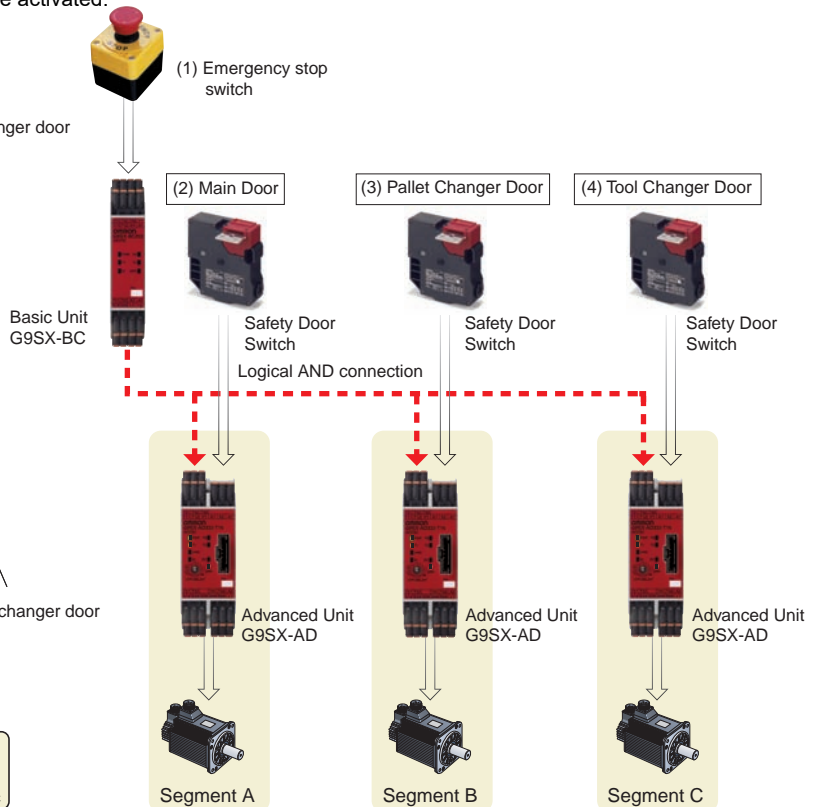
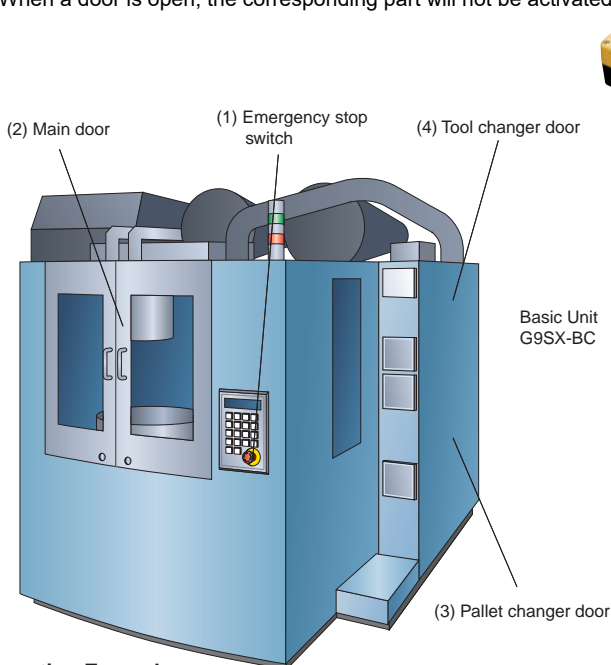

Operating Example

- (1) The emergency stop switch is pressed.
- (2) The main door is opened.

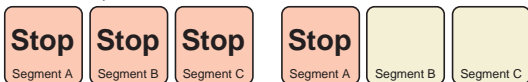

- (3) The pallet changer door is opened.
- (4) The tool changer door is opened.



Semiconductor Manufacturing Equipment

- All of the equipment stops when the emergency stop switch is pressed.
- The processing section and conveyor section stop when the processing section cover is opened.
- Only the conveyor section stops when the conveyor section cover is opened.

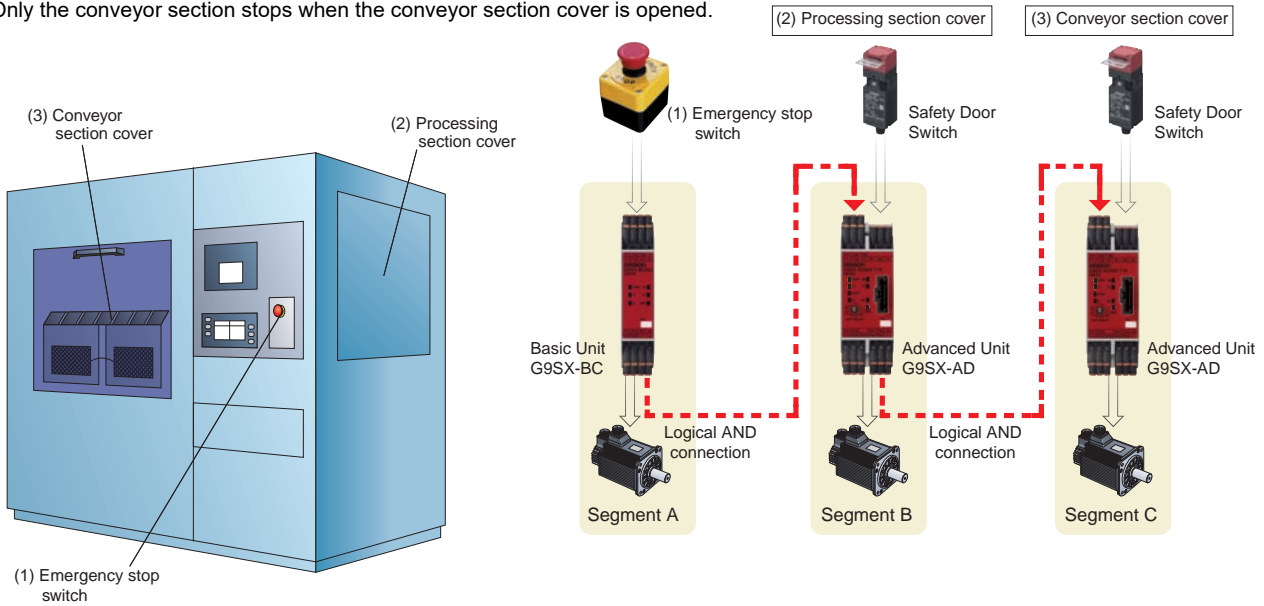

Operating Example

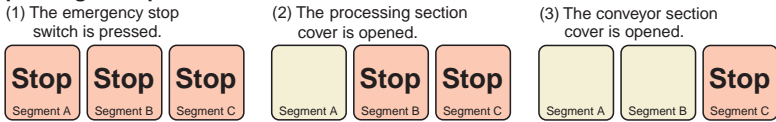

Machine Tool

- When the Emergency Stop Switch is pressed, the entire machine will stop.
- If the left door is opened, the left drive section and transport section will stop.
- If the right door is opened, the right drive section and transport section will stop.

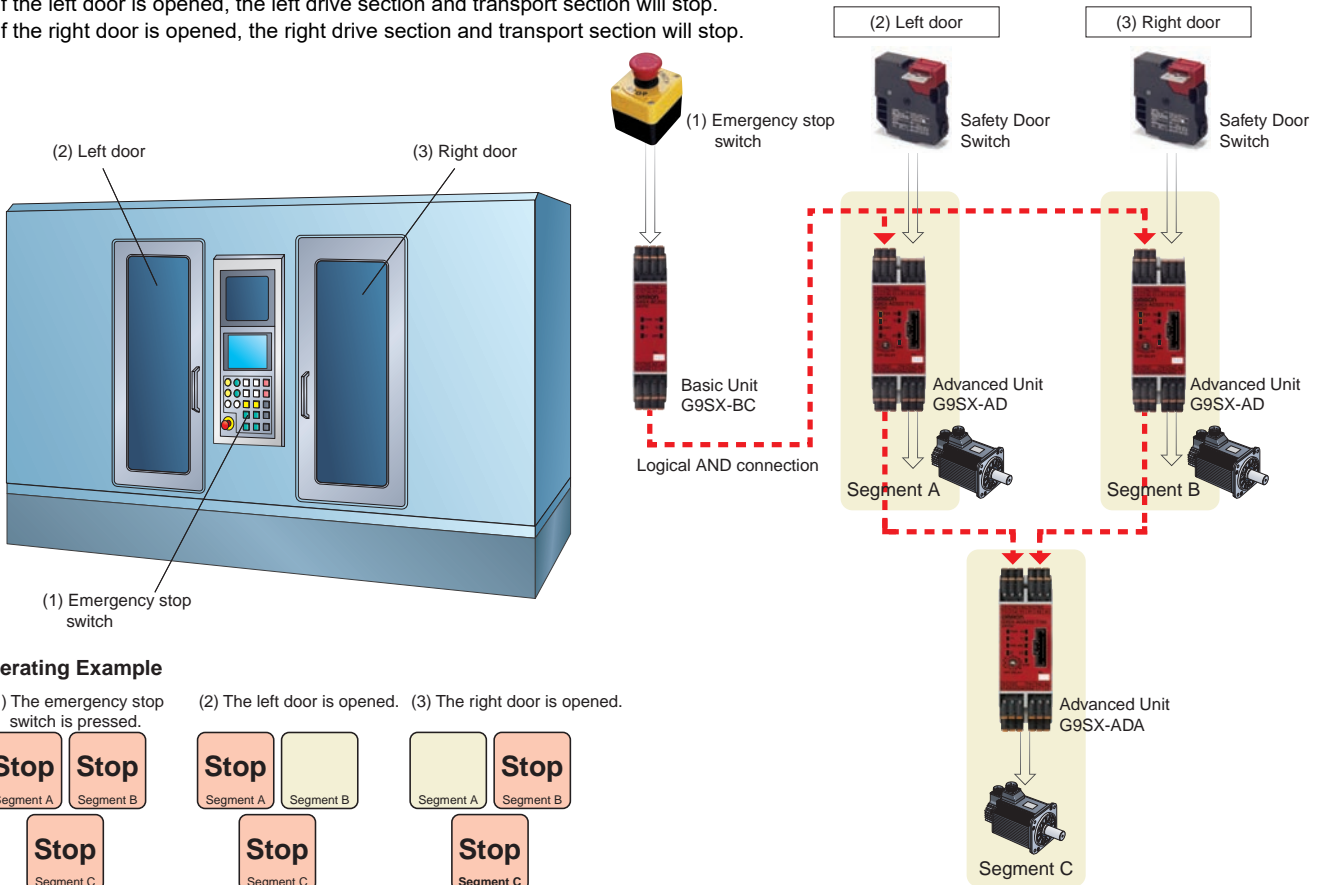

Model Number Structure

Model Number Legend

G9SX-□□□□□□-□□□□-□□□
 1 2 3 4 5 6

Note: Please see "Ordering Information" below for the actual models that can be ordered.

1. Functions

AD/ADA: Advanced Unit
 BC: Basic Unit
 EX: Expansion Unit

2. Output Configuration (Instantaneous Safety Outputs)

0: None
 2: 2 outputs
 3: 3 outputs
 4: 4 outputs

3. Output Configuration (OFF-delayed Safety Outputs)

0: None
 2: 2 outputs
 4: 4 outputs

4. Output Configuration (Auxiliary Outputs)

1: 1 output
 2: 2 outputs

5. Max. OFF-delay Time

Advanced Unit
 T15: 15 s
 T150: 150 s

Basic Unit

No indicator: No OFF delay

Expansion Unit

No indicator: No OFF delay

T: OFF delay

6. Terminal Block Type

RT: Screw terminals
 RC: Spring-cage terminals

Ordering Information

List of Models

Advanced Unit

Safety outputs *3		Auxiliary outputs *4	Logical AND connection		No. of input channels	Max. OFF-delay time *1	Rated voltage	Terminal block type	Model
Instantaneous	OFF-delayed *2		Inputs	Outputs					
3 (Semiconductor)	2 (Semiconductor)	2 (Semiconductor)	1 (Semi-conductor)	1 (Semi-conductor)	1 or 2 channels	15 s	24 VDC	Screw terminals	G9SX-AD322-T15-RT
								Spring-cage terminals	G9SX-AD322-T15-RC
2 (Semiconductor)	2 (Semiconductor)	2 (Semiconductor)	2 (Semi-conductor)	2 (Semi-conductor)	1 or 2 channels	15 s	24 VDC	Screw terminals	G9SX-ADA222-T15-RT
								Spring-cage terminals	G9SX-ADA222-T15-RC
								Screw terminals	G9SX-ADA222-T150-RT
								Spring-cage terminals	G9SX-ADA222-T150-RC

*1. The OFF-delay time can be set in 16 steps as follows:

T15: 0/0.2/0.3/0.4/0.5/0.6/0.7/1/1.5/2/3/4/5/7/10/15 s

T150: 0/10/20/30/40/50/60/70/80/90/100/110/120/130/140/150 s

*2. The OFF-delayed output becomes an instantaneous output by setting the OFF-delay time to 0 s.

*3. P channel MOS-FET output

*4. PNP transistor output

Basic Unit

Safety outputs *1		Auxiliary outputs *2	No. of input channels	Rated voltage	Terminal block type	Model
Instantaneous	OFF-delayed					
2	---	2 (Semiconductor)	1 or 2 channels	24 VDC	Screw terminals	G9SX-BC202-RT
					Spring-cage terminals	G9SX-BC202-RC

*1. P channel MOS-FET output

*2. PNP transistor output

Expansion Unit

Safety outputs		Auxiliary outputs *1	OFF-delay time	Rated voltage	Terminal block type	Model
Instantaneous	OFF-delayed					
4 PST-NO	---	1 (Semiconductor)	---	24 VDC	Screw terminals	G9SX-EX401-RT
					Spring-cage terminals	G9SX-EX401-RC
---	4 PST-NO		*2		Screw terminals	G9SX-EX041-T-RT
					Spring-cage terminals	G9SX-EX041-T-RC

*1. PNP transistor output

*2. The OFF-delay time is synchronized to the OFF-delay time setting in the connected Advanced Unit (G9SX-AD-□/G9SX-ADA-□).

Accessories

Terminal Block

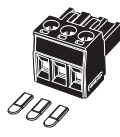
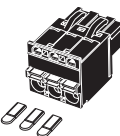
Appearance *	Specifications	Applicable units	Model	Remarks
	Terminal Block with screw terminals (3-pin)	G9SX-AD-□ G9SX-ADA-□	Y9S-03T1B-02A	Two Terminal Blocks (black) with screw terminals, and a set of six code marks to prevent erroneous insertion.
	Terminal Block with screw terminals (4-pin)	G9SX-BC-□ G9SX-EX-□	Y9S-04T1B-02A	Two Terminal Blocks (black) with screw terminals, and a set of six code marks to prevent erroneous insertion.
	Terminal Block with spring-cage terminals (3-pin)	G9SX-AD-□ G9SX-ADA-□	Y9S-03C1B-02A	Two Terminal Blocks (black) with spring-cage terminals, and a set of six code marks to prevent erroneous insertion.
	Terminal Block with spring-cage terminals (4-pin)	G9SX-BC-□ G9SX-EX-□	Y9S-04C1B-02A	Two Terminal Blocks (black) with spring-cage terminals, and a set of six code marks to prevent erroneous insertion.

Note: The G9SX main unit comes with a terminal block as standard equipment. The accessories shown here can be ordered as a replacement.

* The illustrations show 3-pin types

Specifications

Ratings

Power input

Item	Model	G9SX-AD322-□/ADA222-□	G9SX-BC202-□	G9SX-EX-□
Rated supply voltage		24 VDC		
Operating voltage range		-15% to 10% of rated supply voltage		
Rated power consumption *		4 W max.	3 W max.	2 W max.

* Power consumption of loads not included.

Outputs

Item	Model	G9SX-AD322-□/ADA222-□	G9SX-BC202-□
Instantaneous safety output *1 OFF-delayed safety output *1		P channel MOS-FET output Load current: 0.8 A DC max./output *2 *3	P channel MOS-FET output Load current: 0.8 A DC max./output *2 *3
Auxiliary output		PNP transistor output Load current: 100 mA max./output	

*1. While safety outputs are in the ON state, the following signal sequence is output continuously for diagnosis. When using the safety outputs as input signals to control devices (i.e. Programmable Controllers), consider the OFF pulse shown below.

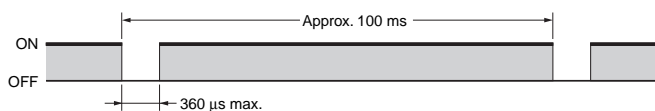

*2. The following derating is required when Units are mounted side-by-side.

G9SX-AD322-□/G9SX-ADA222-□/G9SX-BC202-□: 0.4 A max. load current/output

*3. A load current below 1 A DC/output can be used when the following outputs are used.

G9SX-AD322-□/G9SX-ADA222-□: 2 outputs or less

G9SX-BC202-□: 1 output

Expansion Unit Ratings

Item	Model	G9SX-EX-□
Rated load		250 VAC, 3 A/30 VDC, 3 A (resistive load)
Rated carry current		3 A
Maximum switching voltage		250 VAC, 125 VDC

Characteristics

Item	Model	G9SX-AD322-□/ADA222-□	G9SX-BC202-□	G9SX-EX-□
Overvoltage category (IEC/EN 60664-1)		II		II (Safety relay outputs 13 to 43 and 14 to 44: III)
Operating time (OFF to ON state) *1		50 ms max. (Safety input: ON) *2 100 ms max. (Logical AND connection input: ON) *3	50 ms max. (Safety input: ON)	30 ms max. *4
Response time (ON to OFF state) *1		15 ms max.		10 ms max. *4
Accuracy of OFF-delay time *5		Within ± 5% of the set value	---	Within ± 5% of the set value
Input	Input current	10 mA min.		---
	ON voltage	11 V min.		---
	OFF voltage	5 V min.		---
	OFF current	1 mA max.		---
	Maximum wiring length	100 m max. (External connection impedance: 100 Ω max. and 10 nF max.)		---
	Reset input time	100 ms min.		---
Output	ON-state residual voltage	3.0 V max. (safety output, auxiliary output)		
	OFF-state leakage current	0.1 mA max. (safety output, auxiliary output)		
Insulation resistance	Between logical AND connection terminals, and power supply input terminals and other input and output terminals connected together	20 MΩ min. (at 100 VDC)	---	---
	Between all terminals connected together and DIN track		20 MΩ min. (at 100 VDC)	100 MΩ min. (at 500 VDC)
Dielectric strength	Between logical AND connection terminals, and power supply input terminals and other input and output terminals connected together	500 VAC for 1 min	---	---
	Between all terminals connected together and DIN track		500 VAC for 1 min	1,200 VAC for 1 min
	Between different poles of outputs			2,200 VAC for 1 min
	Between safety relay outputs connected together and other terminals connected together	---	---	---
Vibration resistance		Frequency: 10 to 55 to 10 Hz, 0.375-mm single amplitude (0.75-mm double amplitude)		
Shock resistance	Destruction	300 m/s ²		
	Malfunction	100 m/s ²		
Durability	Electrical	---		100,000 cycles min. (rated load, switching frequency: 1,800 cycles/hour)
	Mechanical	---		5,000,000 cycles min. (switching frequency: 7,200 cycles/hour)
Ambient operating temperature		-10 to 55°C (with no icing or condensation)		
Ambient operating humidity		25% to 85%		
Terminal tightening torque *6		0.5 N·m		
Weight		Approx. 200 g	Approx. 125 g	Approx. 165 g

*1. When two or more Units are connected by logical AND, the operating time and response time are the sum total of the operating times and response times, respectively, of all the Units connected by logical AND.

*2. Represents the operating time when the safety input turns ON with all other conditions set.

*3. Represents the operating time when the logical AND input turns ON with all other conditions set.

*4. This does not include the operating time or response time of Advanced Units that are connected.

*5. This does not include the operating time or response time of internal relays in the G9SX-EX-□.

*6. For the G9SX-□-RT (with screw terminals) only.

Logical AND Connection

Item	Model	G9SX-AD322-□/ADA222-□	G9SX-BC202-□	G9SX-EX-□
Number of Units connected per logical AND output		4 Units max.		---
Total number of Units connected by logical AND *1		20 Units max.		---
Number of Units connected in series by logical AND		5 Units max.		---
Max. number of Expansion Units connected *2		---		5 Units max.
Maximum cable length for logical AND input		100 m max./output		---

Note: See Logical AND Connection Combinations below for details.

*1. The number of G9SX-EX401-□ Expansion Units or G9SX-EX041-T-□ Expansion Units (OFF-delayed Model) not included.

*2. G9SX-EX401-□ Expansion Units and G9SX-EX041-T-□ Expansion Units (OFF-delayed Model) can be mixed.

Logical AND Connection Combinations

- One logical AND connection output from an Advanced Unit G9SX-AD can be logical AND connected to up to four Advanced Units.

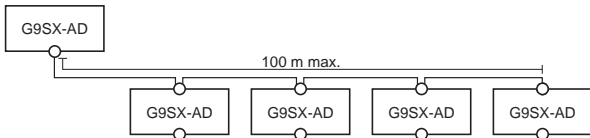

- Two logical AND outputs from a Basic Unit G9SX-BC can be logical AND connected to up to eight Advanced Units.

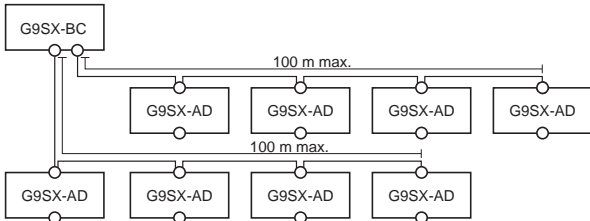

- Two logical AND outputs from an Advanced Unit G9SX-ADA can be logical AND connected to up to eight Advanced Units.

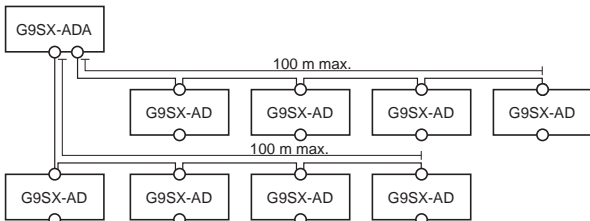

- Any Advanced Unit with logical AND input can be logical AND connected to Advanced Units on up to five tiers.

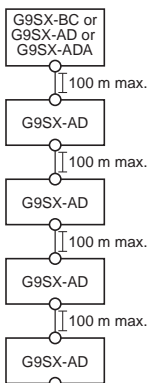

- Two logical AND connection outputs, each from different Advanced/Basic Units, can be logical AND connected to a single G9SX-ADA Unit.

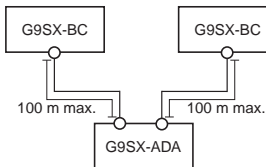

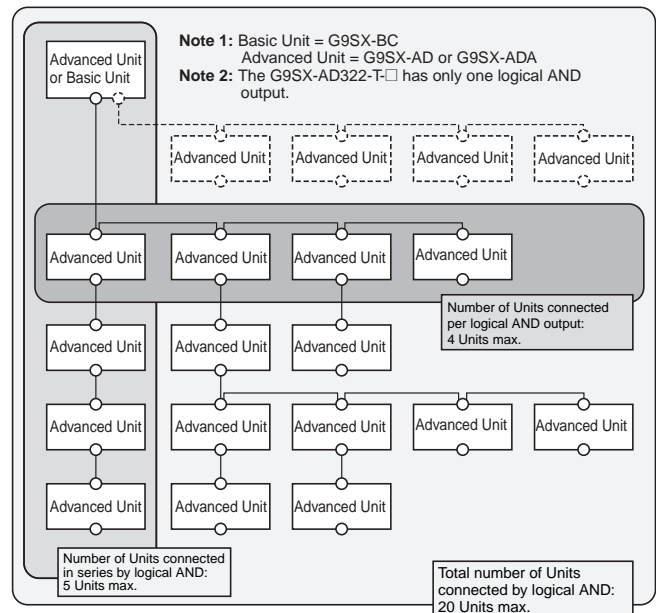

- The largest possible system configuration contains a total of 20 Advanced and Basic Units. In this configuration, each Advanced Unit can have up to five Expansion Units.

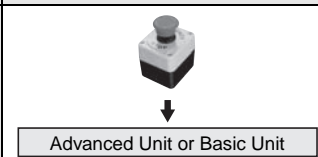

Response Time and Operating Time

The following table shows the response time for two or more Units that are logical AND connected.

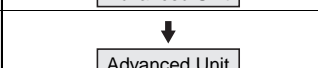
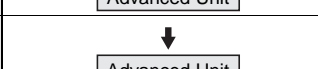
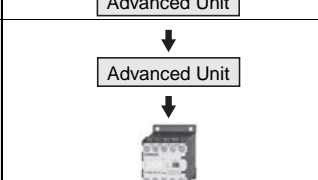
Tier	Item	Block flow diagram	Max. response time *1 (not including Expansion Units)	Max. response time *2 (including Expansion Units)	Max. operating time *3 (not including Expansion Units)	Max. operating time *4 (including Expansion Units)
First tier			15 ms	25 ms	50 ms	80 ms
Second tier			30 ms	40 ms	150 ms	180 ms
Third tier			45 ms	55 ms	250 ms	280 ms
Fourth tier			60 ms	70 ms	350 ms	380 ms
Fifth tier			75 ms	85 ms	450 ms	480 ms

*1. The maximum response time (not including Expansion Units) in this block flow diagram is the time it takes the output from the Unit on the lowest tier to switch from ON to OFF after the input to the Unit on the highest tier switches from ON to OFF.

*2. The maximum response time (including Expansion Units) in this block flow diagram is the time it takes the output from the Expansion Unit connected to the Unit on the lowest tier to switch from ON to OFF after the input to the Unit on the highest tier switches from ON to OFF.

*3. The maximum operating time (not including Expansion Units) in this block flow diagram is the time it takes the output from the Unit on the lowest tier to switch from OFF to ON after the input to the Unit on the highest tier switches from OFF to ON.

*4. The maximum operating time (including Expansion Units) in this block flow diagram is the time it takes the output from the Expansion Unit connected to the Unit on the lowest tier to switch from OFF to ON after the input to the Unit on the highest tier switches from OFF to ON.

Connections

Internal Connection

G9SX-AD322-□ (Advanced Unit)

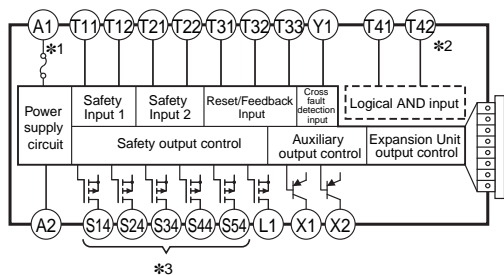

- *1. Internal power supply circuit is not isolated.
- *2. Logical AND input is isolated.
- *3. Outputs S14 to S54 are internally redundant.

G9SX-BC202-□ (Basic Unit)

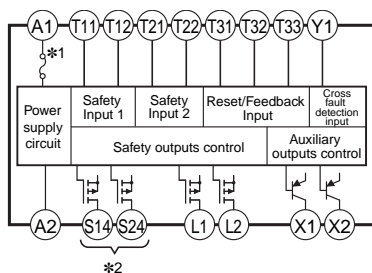

- *1. Internal power supply circuit is not isolated.
- *2. Outputs S14 and S24 are internally redundant.

G9SX-ADA222-□ (Advanced Unit)

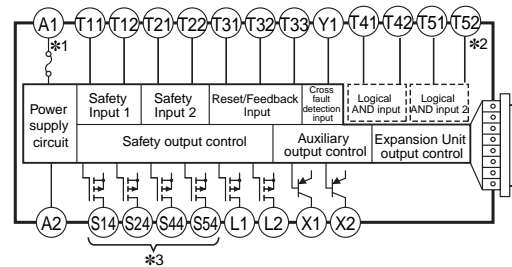

- *1. Internal power supply circuit is not isolated.
- *2. Logical AND inputs are isolated.
- *3. Outputs S14 to S54 are internally redundant.

G9SX-EX401-□/G9SX-EX041-T-□ (Expansion Unit / Expansion Unit OFF-delayed model)

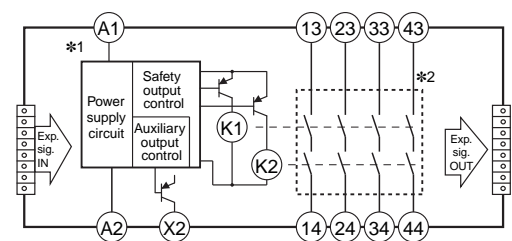

- *1. Internal power supply circuit is not isolated.
- *2. Relay outputs are isolated.

Wiring of Inputs and Outputs

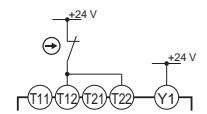
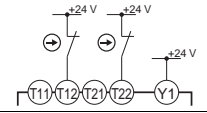
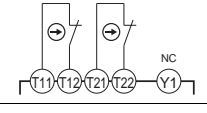
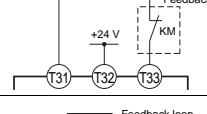
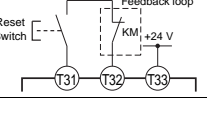
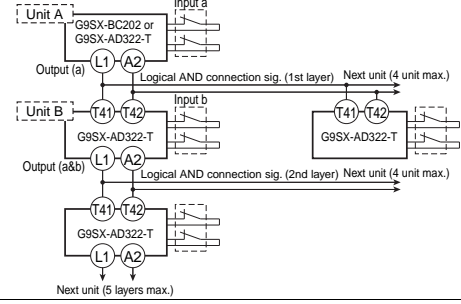
Signal name	Terminal name	Description of operation	Wiring
Power supply input	A1, A2	The input terminals for power supply. Connect the power source to the A1 and A2 terminals.	Connect the power supply plus (24 VDC) to the A1 terminal. Connect the power supply minus (GND) to the A2 terminal.
Safety input 1	T11, T12		Using 1 safety input channel 
Safety input 2	T21, T22	To set the safety outputs in the ON state, the ON state signals must be input to both safety input 1 and safety input 2. Otherwise the safety outputs cannot be in the ON state.	Using 2 safety input channels (cross fault detection OFF) 
			Using 2 safety input channels (cross fault detection ON) 
Feedback/reset input	T31, T32, T33	To set the safety outputs in the ON state, the ON state signal must be input to T33. Otherwise the safety outputs cannot be in the ON state.	Auto reset 
		To set the safety outputs in the ON state, the signal input to T32 must change from the OFF state to the ON state, and then to the OFF state. Otherwise the safety outputs cannot be in the ON state.	Manual reset 
Logical AND connection input	T41, T42, T51, T52	A logical AND connection means that one unit (Unit A) outputs a safety signal "a" to a subsequent unit (Unit B) and Unit B calculates the logical multiplication (AND) (i.e., outputs the AND) of the signal "a" and safety signal "b", which is input to Unit B. Thereby the logic of the safety output of Unit B is "a" AND "b". (An AND of inputs "a" and "b" is output.) To set the safety outputs of the subsequent Unit in the ON state, its logical AND connection preset switch must be set to AND (enable) and the HIGH state signal must be input to T41 of the subsequent unit.	
Cross fault detection input	Y1	Selects the mode for the failure detecting (cross fault detecting) function for the safety inputs of G9SX corresponding to the connection of the cross fault detection input.	Y1 connection varies depending on whether T11 and T21 are used or not. Refer to wiring of the safety input 1 and 2.
Instantaneous safety output	S14, S24, S34	Turns ON/OFF according to the state of the safety inputs, feedback/reset inputs, and logical AND connection inputs. During OFF-delay state, the Instantaneous safety outputs are not able to turn ON.	Keep these outputs open when not used.
OFF-delayed safety output	S44, S54	OFF-delayed safety outputs. The OFF-delay time is set by the OFF-delay preset switch. When the delay time is set to zero, these outputs can be used as instantaneous safety outputs.	Keep these outputs open when not used.
Logical AND connection output	L1, L2	Outputs a signal of the same logic as the instantaneous safety outputs.	Keep these outputs open when not used.
Auxiliary monitor output	X1	Outputs a signal of the same logic as the instantaneous safety outputs	Keep these outputs open when not used.
Auxiliary error output	X2	Outputs when the error indicator is lit or blinking.	Keep these outputs open when not used.

Connecting Safety Sensors and the G9SX

- When connecting safety sensors to the G9SX, the Y1 terminal must be connected to 24 VDC.
The G9SX will detect a connection error, if the Y1 terminal is open.
- In many cases, safety sensor outputs include an OFF-shot pulse for self diagnosis.
The following condition of test pulse is applicable as safety inputs for the G9SX.
 - OFF-shot pulse width of the sensor, during the ON-state: 500 μs max.

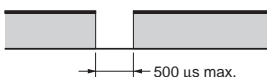

Operation

Functions

Logical AND Connection

● Example with G9SX-AD322-□

The logical AND connection means that the Basic Unit (or Advanced Unit) outputs a safety signal “a” to an Advanced Unit, and the Advanced Unit calculates the logical multiplication (AND) of the safety signal “a” and safety signal “b.” The safety output of an Advanced Unit with the logical AND connection shown in the following diagram is “a” AND “b”.

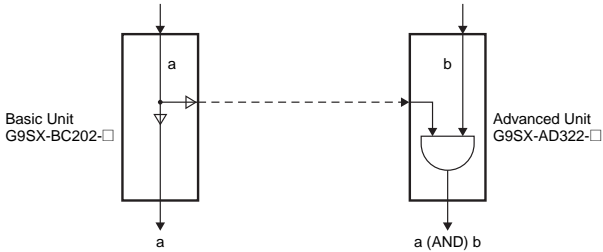

This is illustrated using the application in the following diagram as an example. The equipment here has two hazards identified as Robot 1 and Robot 2, and it is equipped with a safety door switch and an emergency stop switch. You may have overall control where both Robot 1 and Robot 2 are stopped every time the emergency stop switch is pressed. You may also have partial control where only Robot 1, which is closest to the door, is stopped when the door is opened. In that case, Robot 2 will continue to operate. The actual situation using a G9SX for this application is shown in this example.

(Note: The logical AND setting on the Advanced Unit must be set to AND (enabled).)

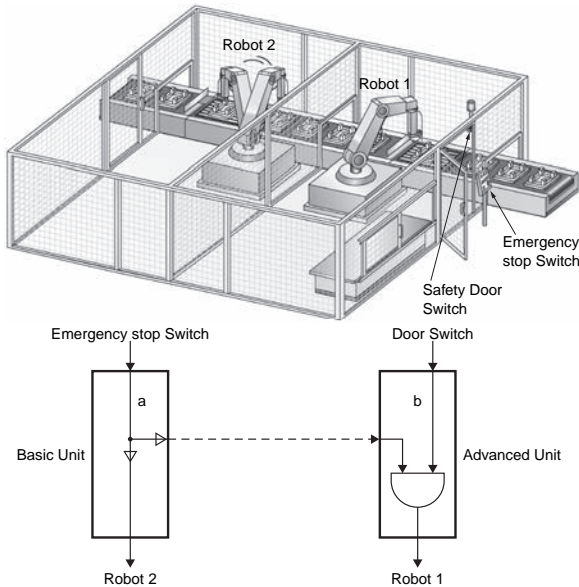

● Example with G9SX-ADA222-□

The Advanced Unit G9SX-ADA222-□ is equipped with two logical AND connection inputs. Therefore, it is capable of receiving two safety signals, each from different Advanced or Basic Units. As shown in the diagram below, the output of Advanced Unit G9SX-ADA222-□ will be “a” AND “b” AND “c”.

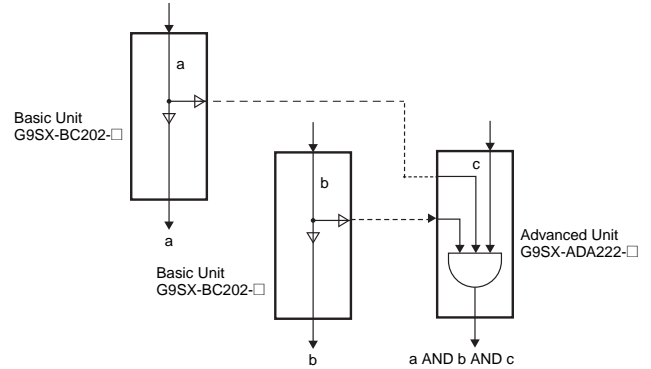

Connecting Expansion Units

- The G9SX-EX and G9SX-EX-T Expansion Units can be connected to an Advanced Unit (G9SX-AD322-□/G9SX-ADA222-□) to increase the number of safety outputs. (They cannot be connected to a Basic Unit.)
- A maximum of five Expansion Units can be connected to one Advanced Unit. This may be a combination of G9SX-EX Instantaneous types and G9SX-EX-T OFF-delayed types.
- Remove the terminating connector from the receptacle on the Advanced Unit and insert the Expansion Unit cable connector into the receptacle on the Expansion Unit at the very end (rightmost).
- When Expansion Units are connected to an Advanced Unit, make sure that power is supplied to every Expansion Unit. (Refer to the following diagram for actual Expansion Unit connection.)

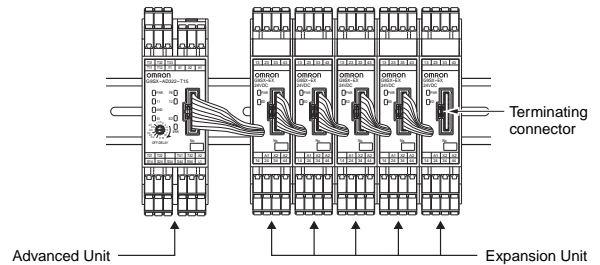

Setting Procedure

1. Cross Fault Detection (Advanced Unit/Basic Unit)

Set the cross fault detection mode for safety inputs by shorting Y1 to 24 V or leaving it open. When cross fault detection is set to ON, short-circuit failures are detected between safety inputs T11-T12 and T21-T22. When a cross fault is detected, the following will occur.

1. The safety outputs and logical AND outputs lock out.
2. The LED error indicator is lit.
3. The error output (auxiliary output) turns ON.

Cross fault detection	Wiring	
OFF	Using 1 safety input channel	
	Using 2 safety input channels	
ON		

2. Reset Mode (Advanced Unit/Basic Unit)

Set the reset mode using feedback/reset input terminals T31, T32, and T33.

Auto reset mode is selected when terminal T32 is shorted to 24 V and manual reset mode is selected when terminal T33 is shorted to 24 V.

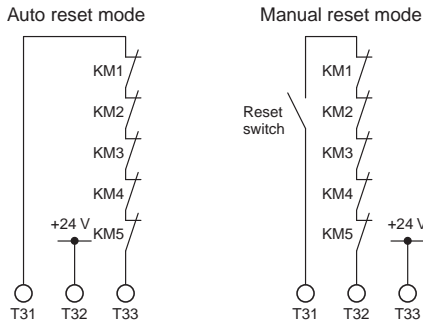

3. Setting Logical AND Connection (Advanced Unit)

When connecting two or more Advanced Units (or Basic Units) by logical AND connection, set the logical AND connection preset switch on the Advanced Unit that is on the input side (Advanced Unit G9SX-AD322 in the following diagram) to AND.

The default setting of the logical AND connection preset switch is set to OFF.

(1) Using G9SX-AD322 on the Input Side

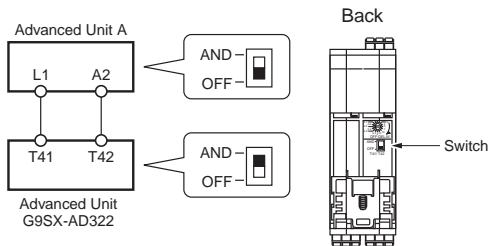

- Note:**
1. A setting error will occur and Advanced Unit G9SX-AD322 will lock out if the logical AND setting switch on the Unit is set to OFF.
 2. Set the logical AND setting switch on Advanced Unit A to OFF or an error will occur.
 3. A logical AND input cannot be sent to a Basic Unit.

(2) Using G9SX-ADA222 on the Input Side

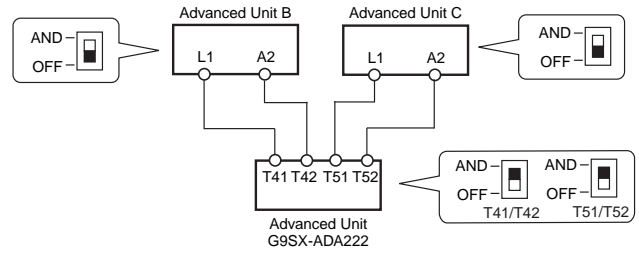

- Note:**
1. When not connecting Advanced Unit B, leave terminals T41 and T42 of the G9SX-ADA222 Advanced Unit open, and set the logical AND setting switch T41/T42 to OFF.
 2. When not connecting Advanced Unit C, leave terminals T51 and T52 of the G9SX-ADA222 Advanced Unit open, and set the logical AND setting switch T51/T52 to OFF.

The following table shows the relationship between the logical ON setting switches and the conditions for safety outputs turning ON.

Logical AND connection preset switch		Conditions for safety outputs turning ON		
T41/T42	T51/T52	Safety input	Logic input 1	Logic input 2
OFF	OFF	ON	OFF	OFF
AND	OFF	ON	ON	OFF
OFF	AND	ON	OFF	ON
AND	AND	ON	ON	ON

4. Setting the OFF-delay Time (Advanced Unit)

The OFF-delay preset time on an Advanced Unit is set from the OFF-delay time preset switch (1 each on the front and back of the Unit). Normal operation will only occur if both switches are identically set. An error will occur if the switches are not identically set. The default setting of the OFF-delay time preset switch is set to 0 s.

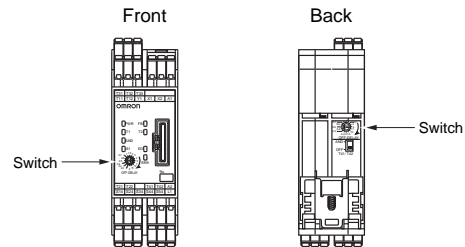

Refer to the following illustration for details on setting switch positions.

G9SX-AD322-T15/G9SX-ADA222-T15

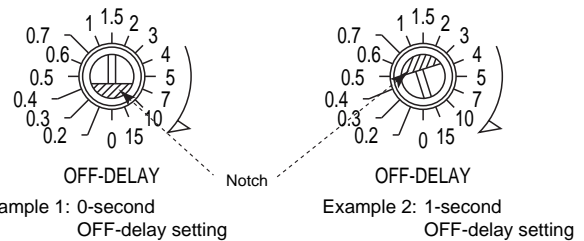

G9SX-AD322-T150/G9SX-ADA222-T150

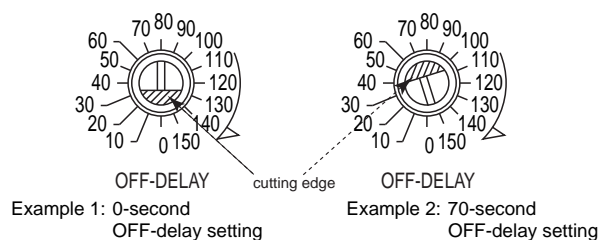

LED Indicators

Marking	Color	Name	G9SX-AD	G9SX-ADA	G9SX-BC	G9SX-EX	G9SX-EX-T	Function	Reference
PWR	Green	Power supply indicator	○	○	○	○	○	Lights up while power is supplied.	---
T1	Orange	Safety input 1 indicator	○	○	○	---	---	Lights up while a HIGH state signal is input to T12. Blinks when an error relating to safety input 1 occurs.	*
T2	Orange	Safety input 2 indicator	○	○	○	---	---	Lights up while a HIGH state signal is input to T22. Blinks when an error relating to safety input 2 occurs.	
FB	Orange	Feedback/reset input indicator	○	○	○	---	---	Lights up in the following cases: • With automatic reset while a HIGH state signal is input to T33. • With manual reset while a HIGH state signal is input to T32. Blinks when an error relating to feedback/reset input occurs.	
AND	Orange	Logical AND input indicator	○	---	---	---	---	Lights up while a HIGH state signal is input to T41. Blinks when an error relating to logical AND connection input occurs.	
AND1	Orange	Logical AND input indicator	---	○	---	---	---	Lights up while a HIGH state signal is input to T41. Blinks when an error relating to logical AND connection input occurs.	
AND2	Orange	Logical AND input indicator	---	○	---	---	---	Lights up while a HIGH state signal is input to T51. Blinks when an error relating to logical AND connection input occurs.	
EI	Orange	Safety output indicator	○	○	○	○	---	Lights up while the Instantaneous safety outputs (S14, S24, S34) are in the ON-state. Blinks when an error relating to the instantaneous safety output occurs.	
ED	Orange	OFF-delayed safety output indicator	○	○	---	---	○	Lights up while OFF-delayed safety outputs (S44, S54) are in the ON-state. Blinks when an error relating to OFF-delayed safety output occurs.	
ERR	Red	Error indicator	○	○	○	○	○	Lights up or blinks when an error occurs.	

* Refer to *Fault Detection* on the next page for details.

Settings Indication (at Power ON)

Settings for the G9SX can be checked by the orange indicators for approx. 3 seconds after the power is turned ON. During this settings indication period, the ERR indicator will light, however the auxiliary error output will remain OFF









Indicator	Item	Setting position	Indicator status	Setting mode	Setting status
T1	Cross fault detection mode	Y1 terminal	Lit	Cross fault detection mode: ON	Y1 = open
			Not lit	Cross fault detection mode: OFF	Y1 = 24 VDC
FB	Reset mode	T32 or T33 terminal	Lit	Manual reset mode	T33 = 24 VDC
			Not lit	Auto reset mode	T32 = 24 VDC
AND (AND1, AND2)	Logical AND connection input mode	Logical AND connection preset switch	Lit	Enable logical AND input	"AND"
			Not lit	Disable logical AND input	"OFF"

Fault Detection





When the G9SX detects a fault, the ERR indicator and/or other indicators light up or blink to inform the user about the fault.

Check and take necessary measures referring to the following table, and then re-supply power to the G9SX.

(Advanced Unit/Basic Unit)

ERR indicator	Other indicator	Fault	Expected causes of the fault	Check points and measures to take	
 Blinks	---	Fault due to electro-magnetic disturbance or of internal circuits.	<ol style="list-style-type: none"> Excessive electro-magnetic disturbance Failure of the internal circuit 	<ol style="list-style-type: none"> Check the disturbance level around the G9SX and the related system. Replace with a new product. 	
 Lights up	 T1 blinks	Fault involved with safety input 1	<ol style="list-style-type: none"> Failure involving the wiring of safety input 1 Incorrect setting of cross fault detection input Failure of the circuit of safety input 1 	<ol style="list-style-type: none"> Check the wiring to T11 and T12. Check the wiring to Y1. Replace with a new product. 	
	 T2 blinks	Fault involved with safety input 2	<ol style="list-style-type: none"> Failure involving the wiring of safety input 2 Incorrect setting of cross fault detection input Failure of circuits of safety input 2 	<ol style="list-style-type: none"> Check the wiring to T21 and T22. Check the wiring to Y1. Replace with a new product. 	
	 FB blinks	Faults involved with feedback/reset input		<ol style="list-style-type: none"> Failures involving the wiring of feedback/reset input. Failures of the circuit of feedback/reset input 	<ol style="list-style-type: none"> Check the wiring to T31, T32 and T33. Replace with a new product.
		Fault in Expansion Unit		<ol style="list-style-type: none"> Improper feedback signals from Expansion Unit Abnormal supply voltage to Expansion Unit Failure of the circuit of safety relay contact outputs 	<ol style="list-style-type: none"> Check the connecting cable of Expansion Unit and the connection of the termination socket. Check the supply voltage to Expansion Unit. Note: Make sure that all Expansion units' PWR indicators are lit. Replace the Expansion Unit with a new one.
	 EI blinks	Fault involved with instantaneous safety outputs or logical AND connection outputs or auxiliary monitor output		<ol style="list-style-type: none"> Failure involving the wiring of instantaneous safety outputs Failure of the circuit of Instantaneous safety outputs Failure involving the wiring of the logical AND connection output Failure of the circuit of the logical AND connection output Failure involving the wiring of the auxiliary monitor output Impermissible high ambient temperature 	<ol style="list-style-type: none"> Check the wiring to S14, S24, and S34. Replace with a new product. Check the wiring to L1 and L2. Replace with a new product. Check the wiring to X1. Check the ambient temperature and spacing around the G9SX.
	 ED blinks	Fault involved with OFF-delayed safety outputs		<ol style="list-style-type: none"> Failure involving the wiring of OFF-delayed safety relay contact outputs Incorrect set values for OFF-delay time Failure of the circuit of OFF-delayed safety relay contact outputs Impermissible high ambient temperature 	<ol style="list-style-type: none"> Check the wiring to S44 and S54. Confirm the set values of the two OFF-delay time preset switches. Replace with a new product. Check the ambient temperature and spacing around the G9SX.
	 AND blinks (AND1, AND2)	Fault involved with logical AND connection input		<ol style="list-style-type: none"> Failure involving the wiring of the logical AND connection input Incorrect setting for the logical AND connection input Failure of the circuit of the logical AND connection input 	<ol style="list-style-type: none"> Check the wiring to T41 and T42 (T51 and T52). Note: Make sure that the wiring length for the T41, T42, T51, T52 terminal is less than 100 meters. Note: Make sure that the logical AND connection signal is branched for less than 4 units. Confirm the set value of the logical AND connection preset switch. Replace with a new product.
 All indicators except PWR blink	Supply voltage outside the rated value		<ol style="list-style-type: none"> Supply voltage outside the rated value 	<ol style="list-style-type: none"> Check the supply voltage to the Units. 	

When indicators other than the ERR indicator blink, check and take necessary actions referring to the following table.

ERR indicator	Other indicators	Fault	Expected cause of the fault	Check points and measures to take			
 Off	<table border="1"> <tr> <td>T1</td> <td rowspan="2"> Blink</td> </tr> <tr> <td>T2</td> </tr> </table>	T1	 Blink	T2	Mismatch between input 1 and input 2.	The input status between input 1 and input 2 is different, due to contact failure or a short circuit of safety input device(s) or a wiring fault.	Check the wiring from safety input devices to the G9SX. Or check the input sequence of safety input devices. After removing the fault, turn both safety inputs to the OFF state.
T1	 Blink						
T2							

(Expansion Unit)

ERR indicator	Other indicators	Fault	Expected cause of the faults	Check points and measures to take
 Lights	---	Fault involved with safety relay outputs of Expansion Units	<ol style="list-style-type: none"> Welding of relay contacts Failure of the internal circuit 	Replace with a new product.

Dimensions and Terminal Arrangement

Advanced Unit

G9SX-AD322-□

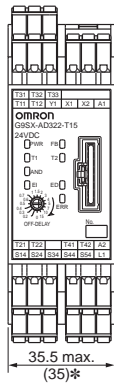
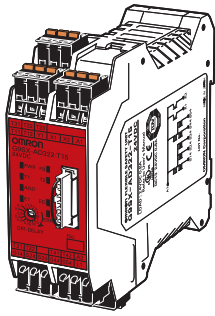

* Typical dimension

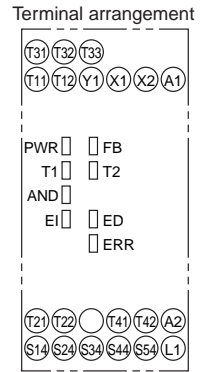
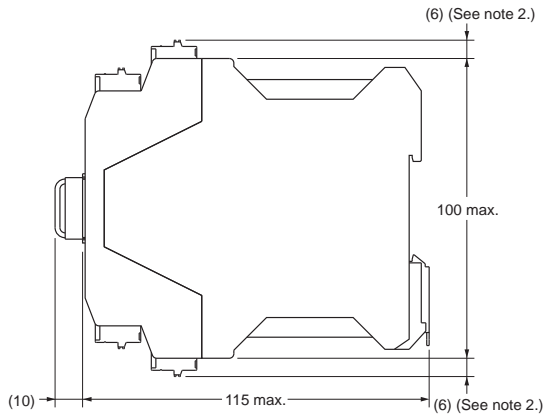

Note: 1. Above outline drawing is for -RC terminal type.
2. For -RC terminal type only.

Advanced Unit

G9SX-ADA222-□

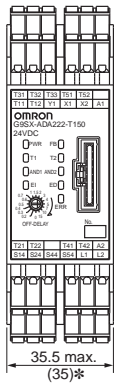
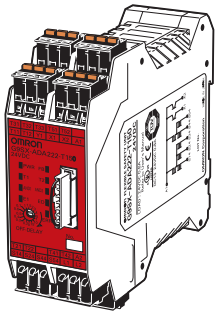

* Typical dimension

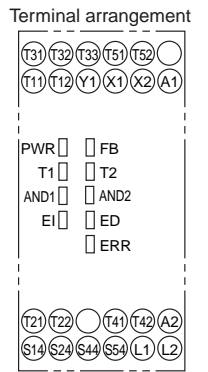
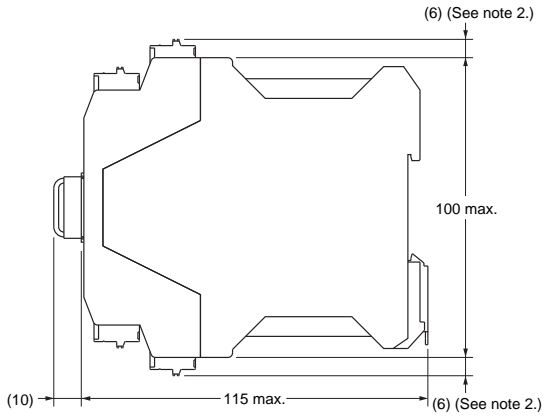

Note: 1. Above outline drawing is for -RC terminal type.
2. For -RC terminal type only.

Basic Unit

G9SX-BC202-□

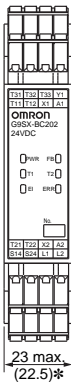
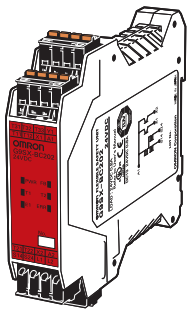

* Typical dimension

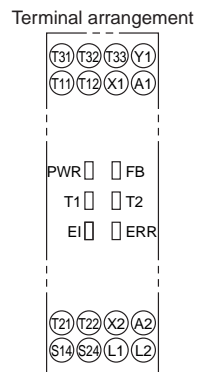
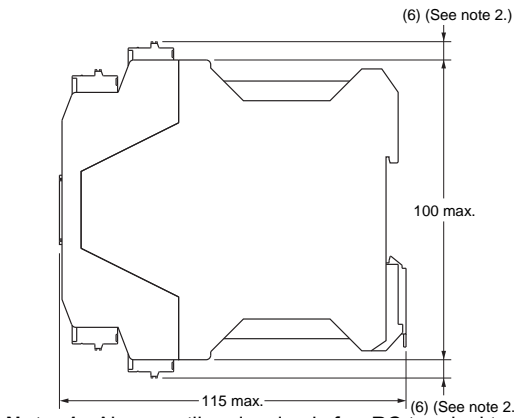

Note: 1. Above outline drawing is for -RC terminal type.
2. For -RC terminal type only.

Expansion Unit

G9SX-EX401-□

Expansion Unit (OFF-delayed Model)

G9SX-EX041-T-□

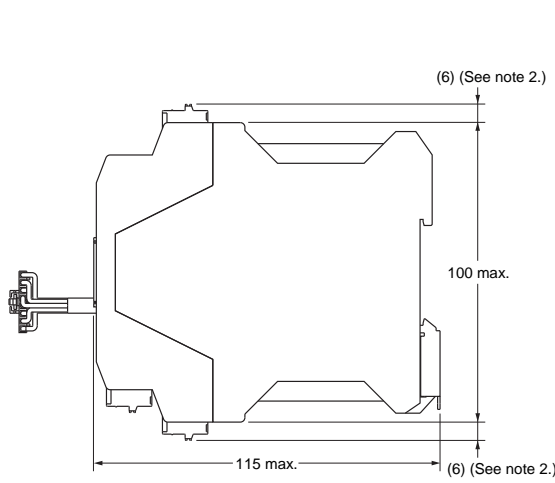
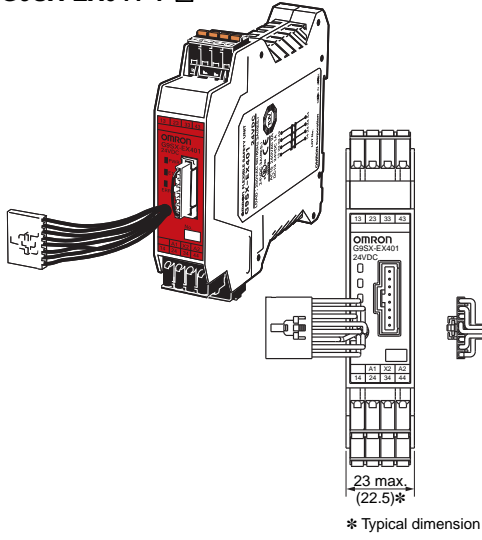

Note: 1. Above outline drawing is for -RC terminal type.
2. For -RC terminal type only.

Terminal arrangement

G9SX-EX401-□
(Expansion Unit)

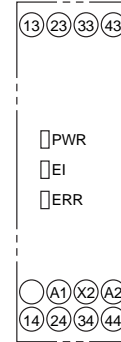

G9SX-EX041-T-□
(Expansion Unit with OFF Delay)

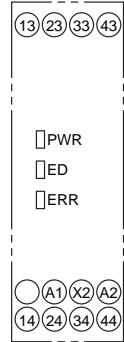

Application Examples

Highest achievable PL/ safety category	Model	Stop category	Reset
PLe/4 equivalent	Emergency Stop Switch A165E/A22 Flexible Safety Unit G9SX-BC202 Safety Limit Switch D4B-N/D4N/D4F Flexible Safety Unit G9SX-AD322-T15	M1, M2: 0	Emergency Stop: Manual Guard: Manual

Note: The above PL is only the evaluation result of the example. The PL must be evaluated in an actual application by the customer after confirming the usage conditions.

● Application Overview 1

- When the emergency stop switch S1 is pressed.
 - The power supply to the motor M1 and M2 is turned OFF immediately when the emergency stop switch S1 is pressed.
 - The power supply to the motor M1 is kept OFF until the emergency stop switch S1 is released and the reset switch S2 is pressed.
 - The power supply to the motor M2 is kept OFF until the guard is closed and the reset switch S2 and S5 are pressed while the emergency stop switch S1 is released.
- When the guard is opened (the emergency stop switch S1 is released).
 - The power supply to the motor M2 is turned OFF immediately when the S3 and S4 detect that the guard is opened. (The power supply to the motor M1 is kept ON.)
 - The power supply to the motor M2 is kept OFF until the guard is closed and the reset switch S5 is pressed.

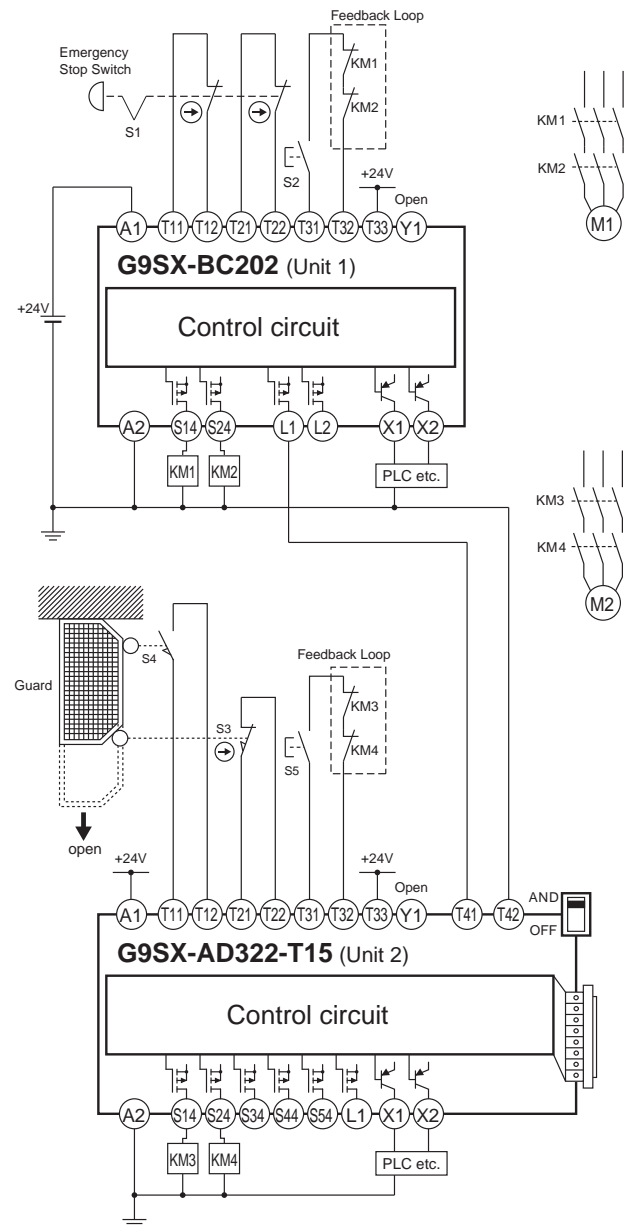

- S1: Emergency Stop Switch
- S2, S5: Reset Switch
- S3: Safety Limit Switch
- S4: Limit Switch
- KM1 to KM6: Magnetic contactor
- M1 to M2: Motor

Timing chart 1

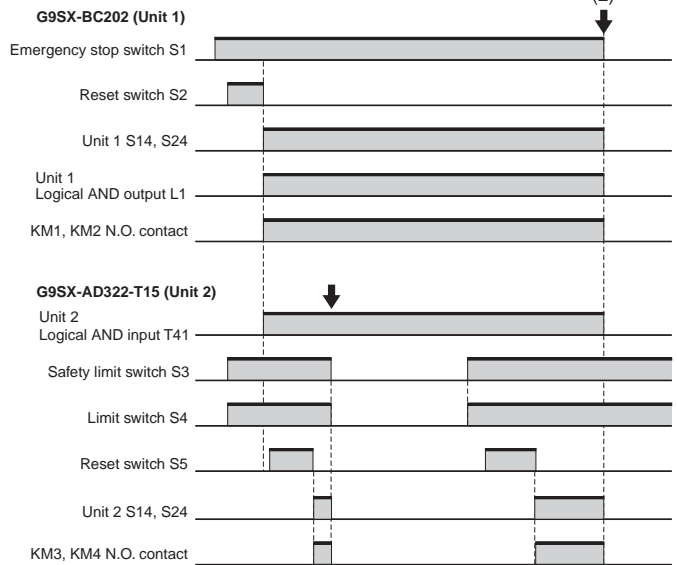

(1) Guard opened: Only the Unit 2 stops.

(2) Emergency stop switch pressed: Both the Unit 1 and 2 stop.

Note: In this example, press reset switch S2, confirm that Unit 1 has started operating, and then press reset switch S5.

Highest achievable PL/ safety category	Model	Stop category	Reset
PLe/4 equivalent	Emergency Stop Switch A165E/A22E Flexible Safety Unit G9SX-BC202 Safety Limit Switch D4B-N/D4N/D4F Safety Light Curtain F3SG Flexible Safety Unit G9SX-AD322-T15 Flexible Safety Unit G9SX-ADA222-T150	M1 to M4: 0	Emergency Stop: Manual Guard 1, 2: Auto Safety Light Curtain: Auto

Note: The above PL is only the evaluation result of the example. The PL must be evaluated in an actual application by the customer after confirming the usage conditions.

● Application Overview 2

1. When the emergency stop switch S1 is pressed.
 - The power supply to the motor M1 to M4 is turned OFF immediately when the emergency stop switch S1 is pressed.
 - The power supply to the motor M1 is kept OFF until the reset switch S2 is pressed while the emergency stop switch S1 is released.
 - The power supply to the motor M2 is kept OFF until the reset switch S2 is pressed while the guard 1 is closed and the emergency stop switch S1 is released.
 - The power supply to the motor M3 is kept OFF until the reset switch S2 is pressed while the guard 2 is closed and the emergency stop switch S1 is released.
 - The power supply to the motor M4 is kept OFF until the reset switch S2 is pressed while the guard 1 and 2 are closed and the safety light curtain is unblocked and the emergency stop switch S1 is released.

2. When the guard 1 is opened (the emergency stop switch S1 is released).
 - The power supply to the motor M2 and M4 is turned OFF immediately when the S3 and S4 detect that the guard 1 is opened.
 - The power supply to the motor M2 is kept OFF until the guard 1 is closed.
 - The power supply to the motor M4 is kept OFF until the guard 1 and 2 are closed and the safety light curtain is unblocked.

3. When the guard 2 is opened (the emergency stop switch S1 is released).
 - The power supply to the motor M3 and M4 is turned OFF immediately when the S5 and S6 detect that the guard 2 is opened.
 - The power supply to the motor M3 is kept OFF until the guard 2 is closed.
 - The power supply to the motor M4 is kept OFF until the guard 1 and 2 are closed and the safety light curtain is unblocked.

4. When the safety light curtain is blocked (the emergency stop switch S1 is released).
 - The power supply to the motor M4 is turned OFF immediately when the safety light curtain is blocked.
 - The power supply to the motor M4 is kept OFF until the guard 1 and 2 are closed and the safety light curtain is unblocked.

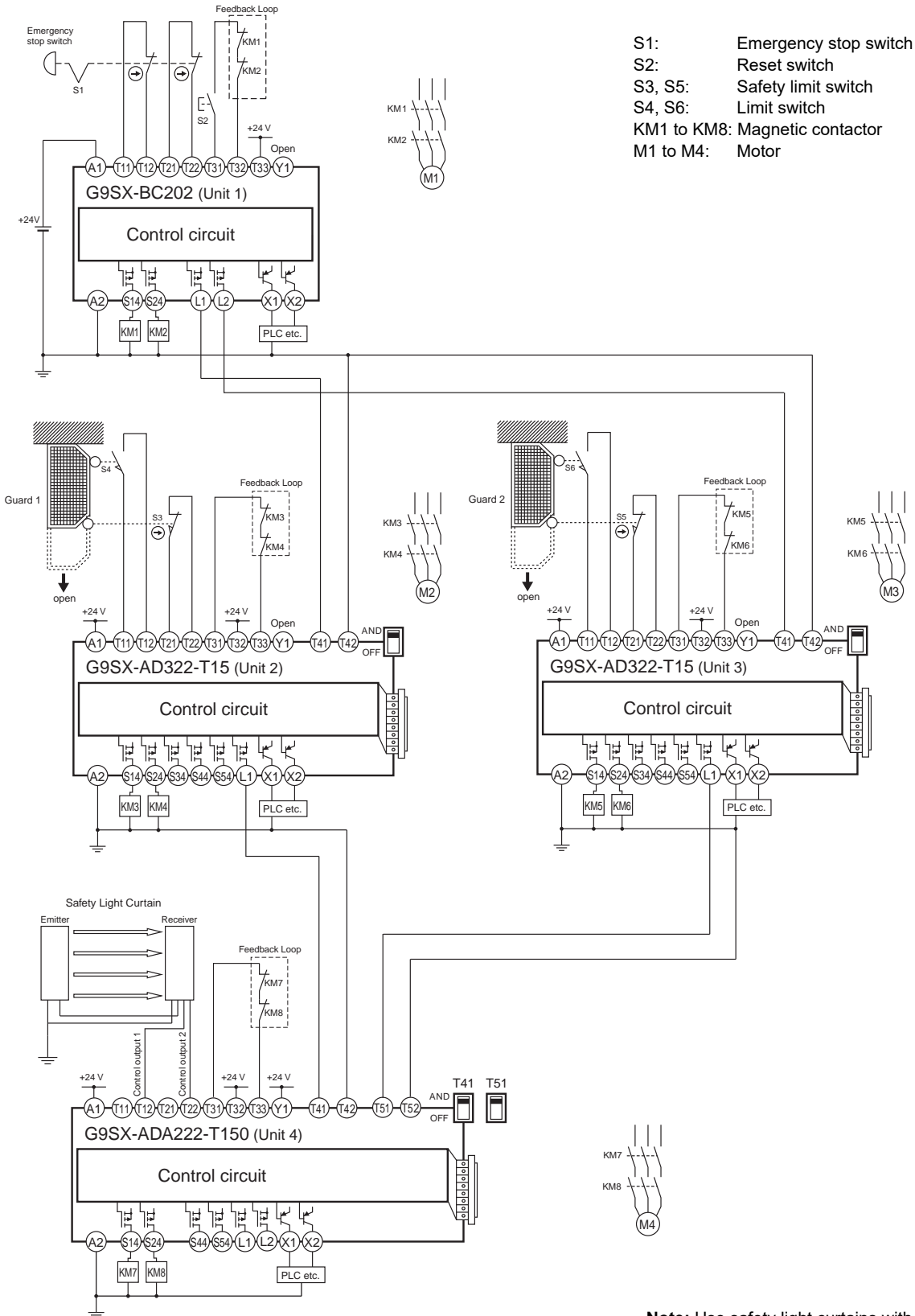

Note: Use safety light curtains with PNP control outputs.

Timing chart 2

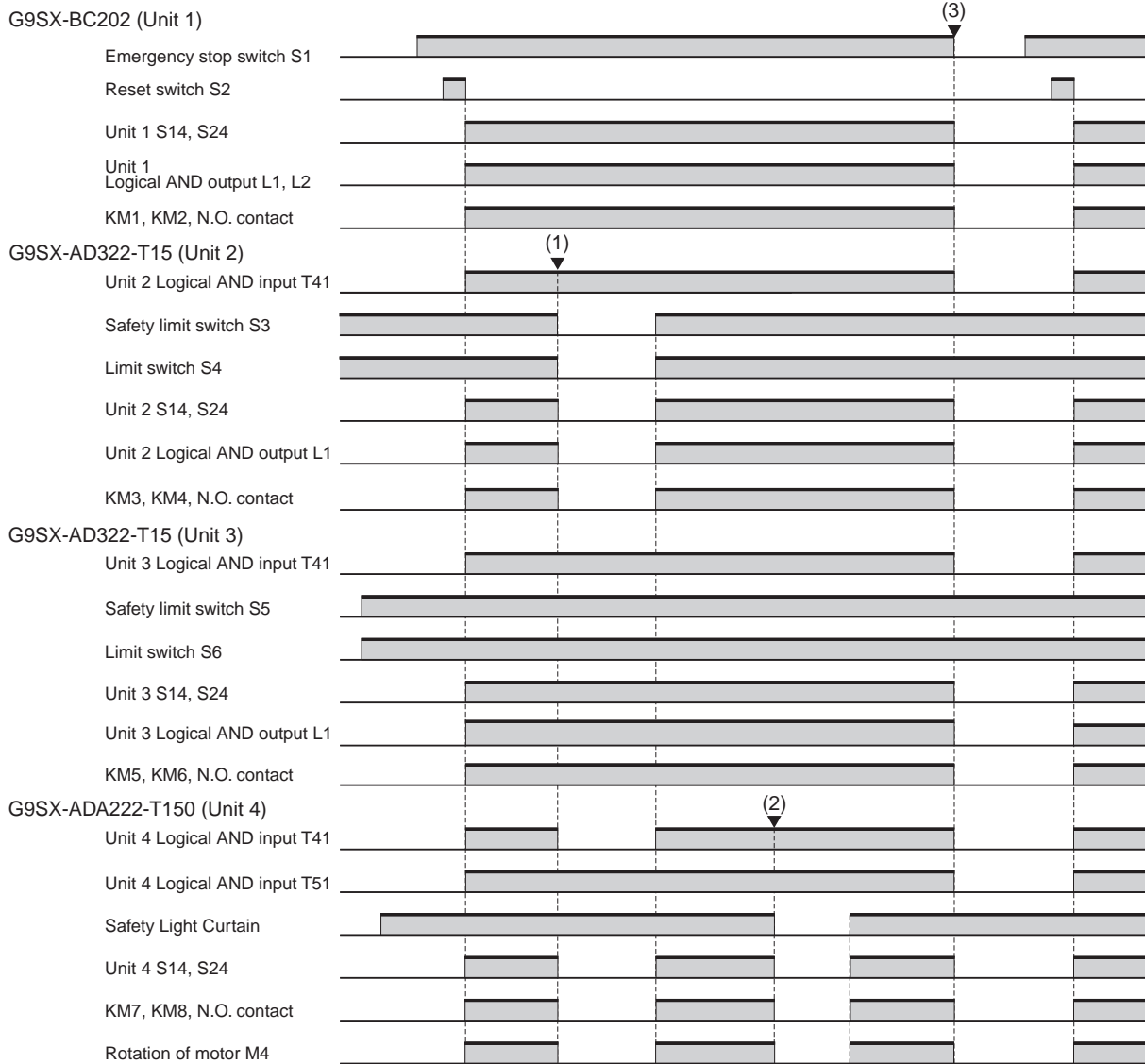

- (1) Guard 1 opened: Unit 2 and Unit 4 stop.
- (2) Guard 3 opened: Unit 4 stops.
- (3) Emergency stop switch pressed: All units stop.

G9SX-GS

A Safety Measure for Hazardous Operations That Does Not Lower Productivity

- Two functions support two types of application:
 - Auto switching: For applications where operators work together with machines
 - Manual switching: For applications with limited operations
- External indicator outputs enable indicating the switching status of two safety input devices.
- Auxiliary outputs enable monitoring of safety inputs, safety outputs, and errors.
- Detailed LED indications enable easy diagnosis.
- Logical AND connection allows complicated applications in combination with other G9SX-series Units.
- Certification for compliance with IEC/EN 61508 (SIL3), IEC/EN 62061 (SIL3) and EN ISO13849-1 (PLe/Safety Category 4).

 Be sure to read the *Safety Precautions* on page 45.

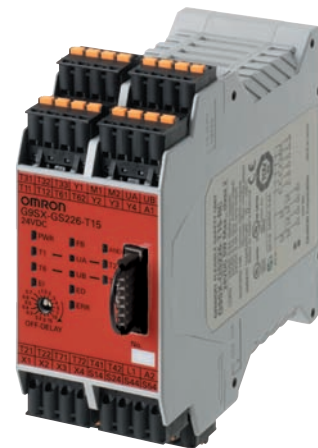

For the most recent information on models that have been certified for safety standards, refer to your OMRON website.

Auto Switching Function

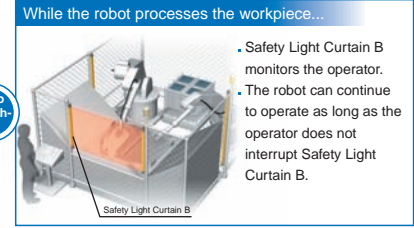
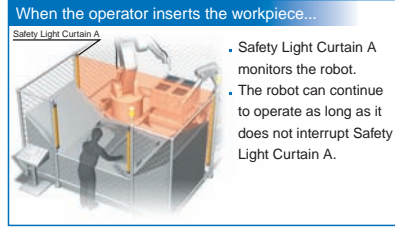

Note: If the operator is able to completely enter the zone inside Safety Light Curtain B, a presence detection device, such as a Safety Mat, is necessary as an additional safety measure.

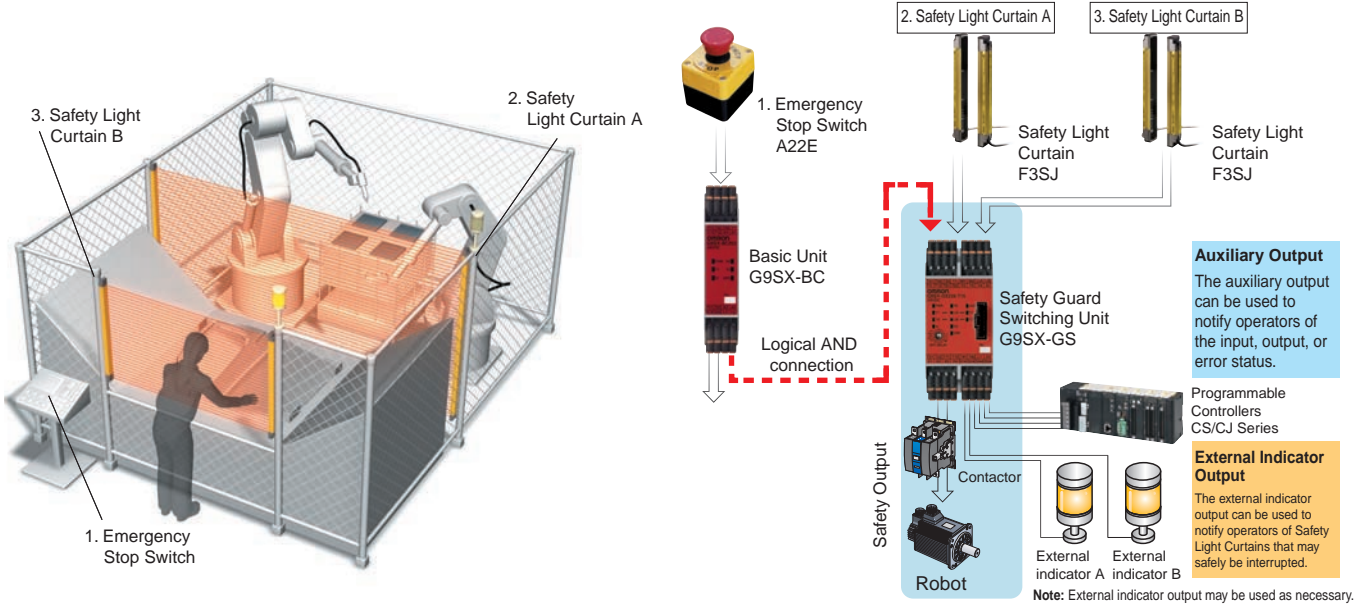

Emergency Stop Switch — When pressed, processing will stop.

Auto switching **Safety Light Curtain A** **Safety Light Curtain B** — When both are interrupted simultaneously, processing will stop.

Refer to pages 37 and 38 for wiring details and timing charts. >>>

	Working condition	External indicator	G9SX-GS			
			Safety input	Safety output	Monitor output	External indicator
Normal operation	<p>1</p>	<p>OK to work</p>	Safety input A ON Safety input B ON	ON Safety output	ON Input A monitor ON Input B monitor	<p>Indicator A Indicator B</p>
	<p>2</p>	<p>OK to work</p>	Safety input A ON Safety input B OFF	ON Safety output	ON Input A monitor OFF Input B monitor	<p>Indicator A Indicator B</p>
	<p>3</p>	<p>Not OK to work</p>	Safety input A OFF Safety input B ON	ON Safety output	OFF Input A monitor ON Input B monitor	<p>Indicator A Indicator B</p>
Hazardous condition	<p>4</p>	<p>Not OK to work</p>	Safety input A OFF Safety input B OFF	OFF Safety output	OFF Input A monitor OFF Input B monitor	<p>Indicator A Indicator B</p>

Manual Switching Function

During normal operation...

- The Door Switch monitors the opening and closing of the door during normal operation.
- The machine is able to operate while the door is closed.

Manual switching (Normal operation)

During maintenance...

- The Limit Switch monitors the conveyor cart position during maintenance.
- The machine is able to operate while the conveyor cart is in a specified area.

Manual switching (Maintenance)

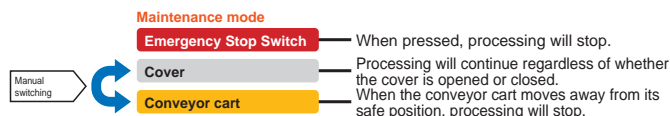
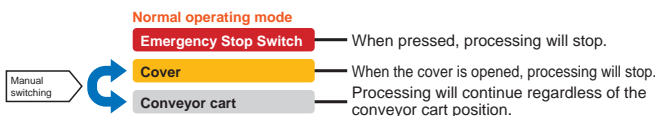
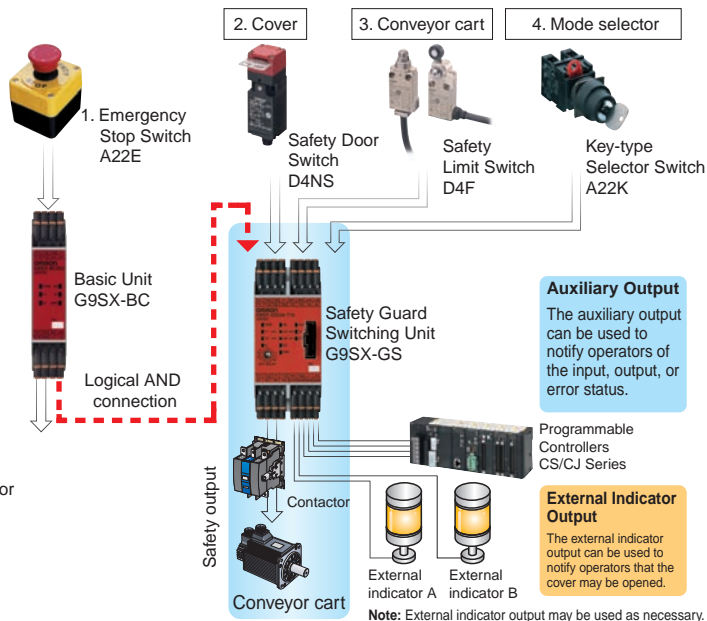
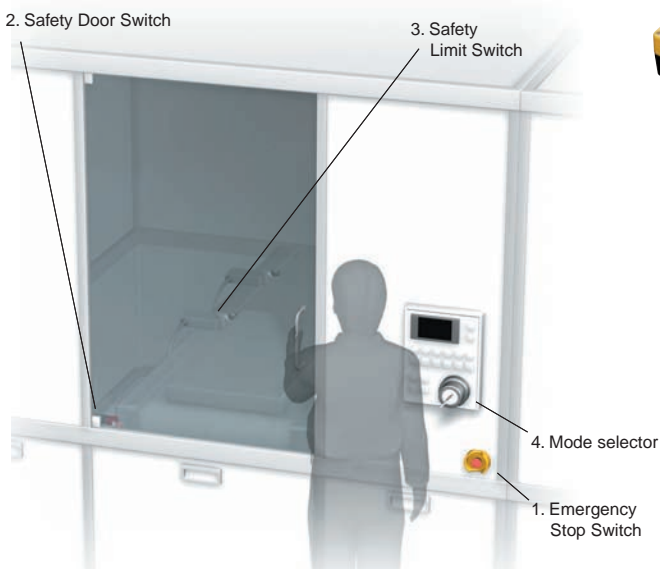

Refer to pages 39 to 41 for wiring details and timing charts.

	Working condition	External indicator	G9SX-GS				
			Safety input	Safety output	Mode selector	Monitor output	External indicator
Normal operation	<p>1</p>	Indicator A Not OK to open	Safety input A Disabled Safety input B ON	ON Safety output	Normal operating mode	OFF Input A monitor ON Input B monitor	Indicator A Indicator B
		Not OK to open OK to open	Safety input A ON Safety input B Disabled	ON Safety output	Maintenance mode	ON Input A monitor OFF Input B monitor	Indicator A Indicator B
Maintenance	<p>2</p>	Not OK to open OK to open	Safety input A ON Safety input B Disabled	ON Safety output	Maintenance mode	ON Input A monitor OFF Input B monitor	Indicator A Indicator B
		Not OK to open OK to open	Safety input A ON Safety input B Disabled	ON Safety output	Maintenance mode	ON Input A monitor OFF Input B monitor	Indicator A Indicator B
Hazardous condition	<p>4</p>	Not OK to open OK to open	Safety input A OFF Safety input B Disabled	OFF Safety output	Maintenance mode	OFF Input A monitor OFF Input B monitor	Indicator A Indicator B

G9SX-GS

Model Number Structure

Model Number Legend

Note: Please see "Ordering Information" below for the actual models that can be ordered.

G9SX-□□□□□□-□□□□-□□□
 1 2 3 4 5 6

1. Functions

GS: Safety Guard Switching Unit
 EX: Expansion Unit

2. Output Configuration (Instantaneous Safety Outputs)

0: None
 2: 2 outputs
 4: 4 outputs

3. Output Configuration (OFF-delayed Safety Outputs)

0: None
 2: 2 outputs
 4: 4 outputs

4. Output Configuration (Auxiliary Outputs)

1: 1 output
 6: 6 outputs

5. Max. OFF-delay Time

Safety Guard Switching Unit
 T15: 15 s
 Expansion Unit
 No indicator: No OFF delay
 T: OFF delay

6. Terminal Block Type

RT: Screw terminals
 RC: Spring-cage terminals

Ordering Information

List of Models

Safety Guard Switching Unit

Safety outputs *3		Auxiliary outputs *4	Logical AND connection		Max. OFF-delay time *1	Rated voltage	Terminal block type	Model
Instantaneous	OFF-delayed *2		Inputs	Outputs				
2 (semiconductor)	2 (semiconductor)	6 (semiconductor)	1 (semiconductor)	1 (semiconductor)	15 s	24 VDC	Screw terminals	G9SX-GS226-T15-RT
							Spring-cage terminals	G9SX-GS226-T15-RC

*1. The OFF-delay time can be set in 16 steps as follows:

T15: 0, 0.2, 0.3, 0.4, 0.5, 0.6, 0.7, 1, 1.5, 2, 3, 4, 5, 7, 10, or 15 s

*2. The OFF-delayed output becomes an instantaneous output by setting the OFF-delay time to 0 s.

*3. P channel MOS-FET output

*4. PNP transistor output (except for the external indicator outputs, which are P channel MOS-FET outputs)

Expansion Unit

Safety outputs		Auxiliary outputs *1	OFF-delay time	Rated voltage	Terminal block type	Model
Instantaneous	OFF-delayed					
4 PST-NO (contact)	---	1 (semiconductor)	---	24 VDC	Screw terminals	G9SX-EX401-RT
					Spring-cage terminals	G9SX-EX401-RC
---	4 PST-NO (contact)		*2		Screw terminals	G9SX-EX041-T-RT
					Spring-cage terminals	G9SX-EX041-T-RC

*1. PNP transistor output

*2. The OFF-delay time is synchronized to the OFF-delay time setting in the connected Unit (G9SX-GS226-T15-□).

Accessories

Terminal Block

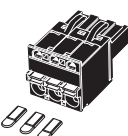
Appearance *	Specifications	Applicable units	Model	Remarks
	Terminal Block with screw terminals (4-pin)	G9SX-GS G9SX-EX-□	Y9S-04T1B-02A	Two Terminal Blocks (black) with screw terminals, and a set of six code marks to prevent erroneous insertion.
	Terminal Block with spring-cage terminals (4-pin)	G9SX-GS G9SX-EX-□	Y9S-04C1B-02A	Two Terminal Blocks (black) with spring-cage terminals, and a set of six code marks to prevent erroneous insertion.

Note: The G9SX main unit comes with a terminal block as standard equipment. The accessories shown here can be ordered as a replacement.

* The illustrations show 3-pin types

Specifications

Ratings

Power Input

Item	Model	G9SX-GS226-T15-□	G9SX-EX-□
Rated supply voltage		24 VDC	
Operating voltage range		-15% to 10% of rated supply voltage	
Rated power consumption *1		5 W max.	2 W max.

*1. Power consumption of loads not included.

Inputs

Item	Model	G9SX-GS226-T15-□
Safety inputs		Operating voltage: 20.4 VDC to 26.4 VDC, Internal impedance: Approx. 2.8 kΩ *2
Mode selector input		
Feedback/reset input		

*2. Provide a current equal to or higher than that of the minimum applicable load of the connected input control device.

Outputs

Item	Model	G9SX-GS226-T15-□
Instantaneous safety outputs *3 OFF-delayed safety outputs *4		P channel MOS-FET outputs Load current: 0.8 A DC max./output *5, 6
Auxiliary outputs (for input, output, and error monitoring)		PNP transistor output Load current: 100 mA DC max.
External indicator outputs		P channel MOS-FET outputs Connectable indicators <ul style="list-style-type: none"> Incandescent lamp: 24 VDC, 3 to 7 W LED lamp: 10 to 300 mA DC/output

*3. While safety outputs are in the ON state, the following signal sequence is output continuously for diagnosis.

When using the safety outputs as input signals to control devices (i.e. Programmable Controllers), consider the OFF pulse shown below.

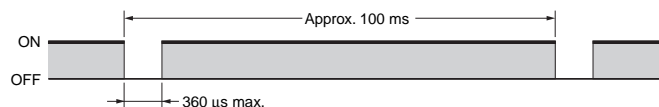

*4. When the safety inputs of G9SX are restored during off-delay time, G9SX will operate as below depending on the reset mode.

- Auto reset mode: Outputs turn off after off-delay time, then immediately turns on.
- Manual reset mode: Outputs turn off after off-delay time, then turn on when reset input is given.

*5. The following derating is required when Units are mounted side-by-side.

G9SX-GS226-T15-□: 0.4 A max. load current/output

*6. The following derating is required when inductive load is connected to safety outputs.

- IEC/EN60947-5-1 DC-13: 0.8 A
- UL508 Pilot Duty: 0.5 A

Expansion Unit

Item	Model	G9SX-EX-□
Rated load		250 VAC, 3 A / 30 VDC, 3 A (resistive load)
Rated carry current		3 A
Maximum switching voltage		250 VAC, 125 VDC

Characteristics

Item	Model	G9SX-GS226-T15-□	G9SX-EX-□
Overvoltage category (IEC/EN 60664-1)		II	II (Safety relay outputs 13 to 43 and 14 to 44: III)
Operating time (OFF to ON state) *1		50 ms max. (Safety input: ON) *2 100 ms max. (Logical AND connection input: ON) *3	30 ms max. *4
Response time (ON to OFF state) *1		15 ms max.	10 ms max. *4
Allowable switching time for mode selector input *5 *7		450 ms max.	---
Response time for switching operating modes *6 *7		50 ms max.	---
ON-state residual voltage		3.0 V max. for safety outputs, auxiliary outputs, and external indicator outputs	
OFF-state leakage current		0.1 mA max. for safety outputs and auxiliary outputs, 1 mA max. for external indicator outputs	
Maximum wiring length of safety input and logical AND input		100 m max. (External connection impedance: 100 Ω max. and 10 nF max.)	
Reset input time (Reset button pressing time)		100 ms min.	
Accuracy of OFF-delay time *8		Within ± 5% of the set value	
Insulation resistance	Between logical AND connection terminals, and power supply input terminals and other input and output terminals connected together	20 MΩ min. (at 100 VDC)	---
	Between all terminals connected together and DIN track		100 MΩ min. (at 500 VDC)
Dielectric strength	Between logical AND connection terminals, and power supply input terminals and other input and output terminals connected together	500 VAC for 1 min	---
	Between all terminals connected together and DIN track		1,200 VAC for 1 min
	Between different poles of outputs	---	---
	Between safety relay outputs connected together and other terminals connected together		2,200 VAC for 1 min
Vibration resistance		Frequency: 10 to 55 to 10 Hz, 0.375-mm single amplitude (0.75-mm double amplitude)	
Shock resistance	Destruction	300 m/s ²	
	Malfunction	100 m/s ²	
Durability	Electrical	---	100,000 cycles min. (rated load, switching frequency: 1,800 cycles/hour)
	Mechanical	---	5,000,000 cycles min. (switching frequency: 7,200 cycles/hour)
Ambient operating temperature		-10 to 55°C (with no icing or condensation)	
Ambient operating humidity		25% to 85%	
Terminal tightening torque *9		0.5 N·m	
Weight		Approx. 240 g	Approx. 165 g

*1. When two or more Units are connected by logical AND, the operating time and response time are the sum total of the operating times and response times, respectively, of all the Units connected by logical AND.

*2. Represents the operating time when the safety input turns ON with all other conditions set.

*3. Represents the operating time when the logical AND input turns ON with all other conditions set.

*4. This does not include the operating time or response time of Safety Guard Switching Units that are connected.

*5. This is the allowable switching time for the operating mode selector. If switching takes more than 450 ms, the G9SX-GS□ will detect an error.

*6. This is the time required for the safety input to actually switch to an activated condition after the mode selector input is switched.

(When M2 turns ON after M1 turns OFF)

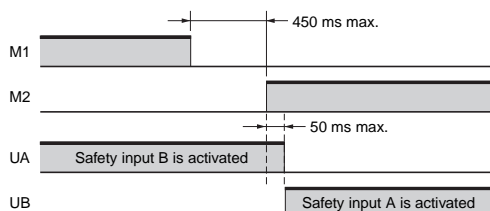

(When M1 turns OFF after M2 turns ON)

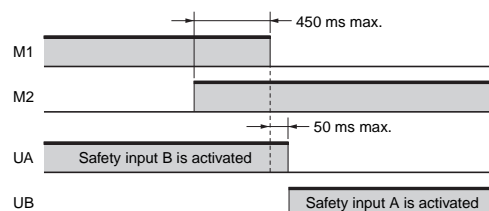

*7. Only when the G9SX-GS□ is used with manual switching.

*8. This does not include the operating time or response time of internal relays in the G9SX-EX-□.

*9. For the G9SX-□-RT (with screw terminals) only.

Logical AND Connection

Note: Please see *Ordering Information* below for the actual models that can be ordered.

Item	Model	G9SX-GS226-T15-□	G9SX-EX-□
Number of Units connected per logical AND output		4 Units max.	---
Total number of Units connected by logical AND *1		20 Units max.	---
Number of Units connected in series by logical AND		5 Units max.	---
Max. number of Expansion Units connected *2		---	5 Units max.
Maximum cable length for logical AND input		100 m max.	---

*1. The number of G9SX-EX401-□ Expansion Units or G9SX-EX041-T-□ Expansion Units (OFF-delayed Model) not included.

*2. G9SX-EX401-□ Expansion Units and G9SX-EX041-T-□ Expansion Units (OFF-delayed Model) can be mixed.

Connections

Internal Connection

G9SX-GS226-T15 □ (Safety Guard Switching Unit)

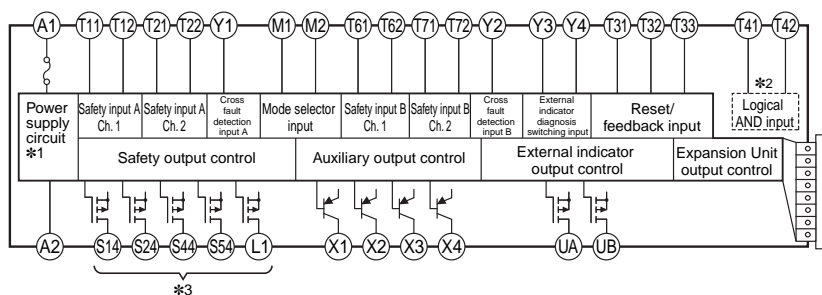

*1. Internal power supply circuit is not isolated.

*2. Logical AND input is isolated.

*3. Outputs S14 to S54 and L1 are internally redundant.

G9SX-EX401-□/G9SX-EX041-T-□

(Expansion Unit/Expansion Unit with OFF Delay)

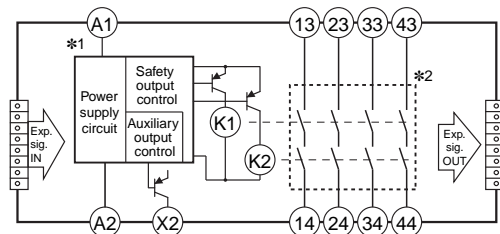

*1. Internal power supply circuit is not isolated.

*2. Relay outputs are isolated.

G9SX-AD□/BC/EX

G9SX-GS

G9SX-AD□/BC/EX,
G9SX-GS Common

G9SX-SM

G9SX-NS

Wiring of Inputs and Outputs

Signal name	Terminal name	Description of operation	Wiring
Power supply input	A1, A2	The power supply input terminals for the G9SX-GS□. Connect the power source to the A1 and A2 terminals.	Connect the power supply plus (24 VDC) to the A1 terminal. Connect the power supply minus (GND) to the A2 terminal.
Safety input A, channel 1	T11, T12	<p>Using Auto Switching: For the safety output to go to the ON state, both channels 1 and 2 of safety input A must be in the ON state, channels 1 and 2 of safety input B must be in the ON state.</p> <p>Using Manual Switching: For the safety output to go to the ON state when safety input A is activated, both channels 1 and 2 of safety input A must be in the ON state (for maintenance mode). For the safety output to go to the ON state when safety input B is activated, both channels 1 and 2 of safety input B must be in the ON state (for normal operating mode).</p>	Using 1 safety input channel
Safety input A, channel 2	T21, T22		Using 2 safety input channels (cross fault detection OFF)
Safety input B, channel 1	T61, T62		Using 2 safety input channels (cross fault detection ON)
Safety input B, channel 2	T71, T72		Using 1 safety input channel
Feedback/reset input	T31, T32, T33	<p>For the safety output to go to the ON state, the ON state signal must be input to T33. Otherwise the safety outputs cannot be in the ON state.</p> <p>For the safety output to go to the ON state, the signal input to T32 must change from the OFF state to the ON state, and then to the OFF state. Otherwise the safety outputs cannot be in the ON state.</p>	Auto reset
			Manual reset
Logical AND connection input	T41, T42	<p>A logical AND connection means that one Unit (Unit A) outputs a safety signal "a" to a subsequent Unit (Unit B) and Unit B calculates the logical AND of "a" and safety signal "b." In the example shown at the right, the logical AND connection results in a safety output of "a AND b" for Unit B.</p> <p>Connect L1 of Unit A and T41 of Unit B to the power supply negative terminal (GND) of Unit A and T42 of Unit B.</p> <p>For the safety output to go to the ON state in the subsequent Unit, its logical AND connection preset switch must be set to AND (enabled) and the HIGH state signal must be input to T41 of the subsequent Unit.</p>	
Mode selector input	M1, M2	<p>When manual switching is selected, the SPST-NO/ SPST-NC input enables the input of either safety input A or safety input B. The relationship of the safety input enable state and the mode selector input is as follows: M1 = ON, M2 = OFF: Safety input B is enabled (normal operating mode) M1 = OFF, M2 = ON: Safety input A is enabled (maintenance mode)</p>	<p>Keep the circuits open when using auto switching.</p>
Cross fault detection inputs	Y1, Y2	Selects the mode for the failure detecting (cross fault detecting) function for the safety inputs of G9SX-GS□ corresponding to the connection of the cross fault detection input.	<p>Keep Y1 open when using T11 and T21 (wiring to enable cross fault detection). Keep Y2 open when using T61 and T71 (wiring to enable cross fault detection). Connect Y1 to 24 VDC when not using T11 and T21 (wiring to disable cross fault detection, or when connecting safety sensors). Connect Y2 to 24 VDC when not using T61 and T71 (wiring to disable cross fault detection, or when connecting safety sensors).</p>
External indicator diagnosis switching inputs	Y3, Y4	Enables or disables error detection for the external indicator outputs of the G9SX-GS□.	<p>Keep Y3 open when detecting errors for UA. Keep Y4 open when detecting errors for UB. Connect Y3 to 24 VDC when not detecting errors for UA. Connect Y4 to 24 VDC when not detecting errors for UB.</p>

Signal name	Terminal name	Description of operation	Wiring
Instantaneous safety outputs	S14, S24	Turns ON/OFF according to the state of the safety inputs, feedback/reset input, and logical AND connection input. During OFF-delay state, the instantaneous safety outputs cannot turn ON.	Keep these outputs open when not used.
OFF-delayed safety outputs	S44, S54	OFF-delayed safety outputs. The OFF-delay time is set by the OFF-delay preset switch. When the delay time is set to zero, these outputs can be used as instantaneous safety outputs.	Keep these outputs open when not used.
Logical AND connection output	L1	Outputs a signal of the same logic as the instantaneous safety outputs.	Keep this output open when not used.
Auxiliary monitor output	X1	Outputs a signal of the same logic as the instantaneous safety outputs	Keep this output open when not used.
Auxiliary error output	X2	Outputs when the error indicator is lit or blinking.	Keep this output open when not used.
Auxiliary monitor outputs	X3, X4	X3 outputs a signal that is synchronized with and has the same logic as the input state of safety input A. X4 outputs a signal that is synchronized with and has the same logic as the input state of safety input B.	Keep these outputs open when not used.
External indicator outputs	UA, UB	Outputs the disabled state of the safety input. UA outputs a signal that is synchronized and has the same logic as the disabled state of safety input A. UB outputs a signal that is synchronized and has the same logic as the disabled state of safety input B.	Keep these outputs open when not used.

Connecting Safety Sensors and G9SX-GS□

- To input the control output from safety sensors to the G9SX-GS□, the Y1 terminal must be connected to 24 VDC when the control output is connected to channel A. Likewise, the Y2 terminal must be connected to 24 VDC when the control output is connected to channel B. The G9SX-GS□ will detect a connection error if these terminals are not connected to 24 VDC.
- In many cases, safety sensor outputs include an OFF-shot pulse for self diagnosis.

The following condition of test pulse is applicable as safety inputs for the G9SX.

- OFF-shot pulse width of the sensor, during the ON-state: 500 μs max.

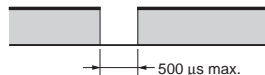

Functions

Auto Switching Function

The following table shows the relationship between the safety inputs and safety outputs of the G9SX-GS□ when auto switching is selected.

Safety input A	ON	ON	OFF	OFF
Safety input B	ON	OFF	ON	OFF
Safety output	ON	ON	ON	OFF

- Note:**
1. If the logical AND connection input is enabled, it must be ON as a necessary condition for the above table.
 2. Select either auto reset or manual reset for the reset mode, depending on the operation of the application.

Manual Switching Function

As shown in the following table, the relationship between the safety inputs and safety outputs of the G9SX-GS□ depends on the setting of the connected mode selector when manual switching is selected.

Mode Selector = Normal Operating Mode (M1 = ON, M2 = OFF)

Safety input A	ON	ON	OFF	OFF
Safety input B	ON	OFF	ON	OFF
Safety output	ON	OFF	ON	OFF

Mode Selector = Maintenance Mode (M1 = OFF, M2 = ON)

Safety input A	ON	ON	OFF	OFF
Safety input B	ON	OFF	ON	OFF
Safety output	ON	ON	OFF	OFF

- Note:**
1. If the logical AND connection input is enabled, it must be ON as a necessary condition for the above table.
 2. Select either auto reset or manual reset for the reset mode, depending on the operation of the application.

Logical AND Connection

The logical AND connection means that one Unit (Unit A) outputs a safety signal "a" to a subsequent Unit (Unit B) and Unit B calculates the logical AND between safety signal "a" and safety signal "b." In the example shown below, the logical AND connection results in a safety output of "a AND b" for Unit B.

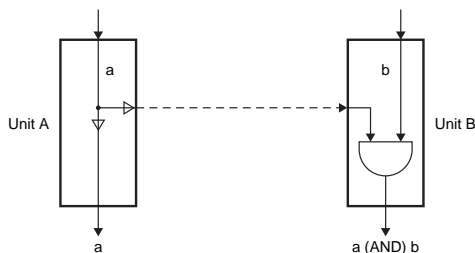

External Indicator Outputs

The operator can be notified of two safety input states (enabled/disabled) by connecting external indicator outputs UA and UB to indicators. External indicator outputs UA and UB turn ON when safety inputs A and B, respectively, are disabled, and turn OFF when safety inputs A and B, respectively, are enabled.

If error monitor output X2 turns ON, UA and UB will both turn OFF.

Auto Switching Selected

External indicator output	Description of operation	Output ON condition
UA	Safety input A is disabled.	Safety input B is ON.
UB	Safety input B is disabled.	Safety input A is ON.

Manual Switching Selected

External indicator output	Description of operation	Output ON condition
UA	Safety input A is disabled.	Mode selector switch must be set to normal operating mode.
UB	Safety input B is disabled.	Mode selector switch must be set to maintenance mode.

Note: Fault of external indicators can be detected. (Refer to page 32.)

Auxiliary Outputs

Auxiliary outputs X1 to X4 can be used to notify the operator of input, output, and error states, as shown in the following table.

Terminal name	Signal name	Output ON condition
X1	Auxiliary monitor output	X1 is ON when the instantaneous safety output is ON.
X2	Auxiliary error output	X2 is ON when the error LED is lit or flashing.
X3	Input A monitor	X3 is ON when safety input A is ON.
X4	Input B monitor	X4 is ON when safety input B is ON.

Connecting Expansion Units

- The G9SX-EX and G9SX-EX-T Expansion Units can be connected to the G9SX-GS226-T15-□ to increase the number of safety outputs.
- A maximum of five Expansion Units can be connected to one G9SX-GS226-T15-□. This may be a combination of the G9SX-EX Instantaneous Expansion Unit and the G9SX-EX-T OFF-delayed Expansion Unit.
- Remove the terminating connector from the receptacle on the G9SX-GS226-T15-□ and insert the Expansion Unit cable connector into the receptacle. Insert the terminating connector into the receptacle on the Expansion Unit at the very end (rightmost).
- When Expansion Units are connected to the G9SX-GS226-T15-□, make sure that power is supplied to every Expansion Unit. (Refer to the following diagram for actual Expansion Unit connections.)

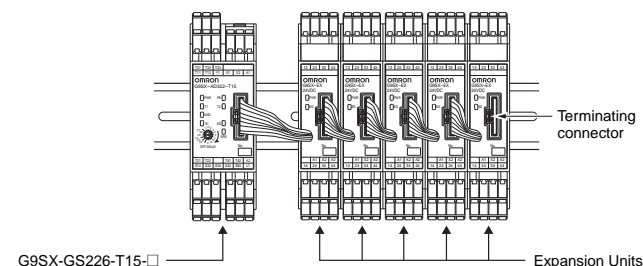

Setting Procedure

1.Switching Function

Auto or manual switching is set by using the Switching Function setting switch on the bottom of the G9SX-GS. Set the switch to *Auto* for auto switching and *Manual* for manual switching.

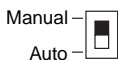

For manual switching, connect the mode selector as shown in the following table.

Switching function	Mode selector connection
Auto switching	
Manual switching	<p>M1 ON, M2 OFF: Normal operating mode M1 OFF, M2 ON: Maintenance mode</p>

2.Reset Mode

Set the reset mode using feedback/reset input terminals T31, T32, and T33. Auto reset mode is selected when terminal T32 is shorted to 24 V and manual reset mode is selected when terminal T33 is shorted to 24 V.

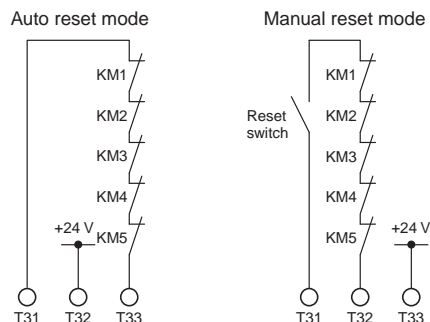

3.Cross Fault Detection

When connecting a Door Switch or other safety input device, you can use Y1 or Y2 to switch the cross fault detection setting. When Y1 is open, short-circuit failures are detected between safety inputs T11-T12 and T21-T22. When Y2 is open, short-circuit failures are detected between safety inputs T61-T62 and T71-T72. When a cross fault is detected, the following will occur.

1. The safety outputs and logical AND output will be locked out.
2. The LED error indicator will light.
3. The error output (auxiliary output) will turn ON.

When a safety sensor, such as a Safety Light Curtain, is connected to safety input A, connect Y1 to 24 V. When a safety sensor is connected to safety input B, connect Y2 to 24 V. If they are not connected to 24 V, the G9SX-GS will detect an error.

Cross fault detection	Equivalent safety category	Safety input A	Safety input B
OFF	Using 1 safety input channel		
	Using 2 safety input channels		
ON			

4. Diagnostic Checks of External Indicators

Diagnostic checks of external indicators connected to external indicator outputs UA and UB can be switched with Y3 and Y4, respectively. Enabling the diagnostic check makes it possible to detect indicator burnout or wiring errors.

If there is no indicator connected to external indicator output UA, connect Y3 to 24 V. If there is no indicator connected to external indicator output UB, connect Y4 to 24 V. If they are not connected to 24 V, the G9SX-GS will detect an error.

External indicator output	Diagnostic check enabled	Diagnostic check disabled
UA		
UB		

Note: Diagnostic checks cannot be made for LED indicators. Disable the diagnostic check if using LED indicators.

5. Setting Logical AND Connection

When connecting two or more Units using a logical AND connection, set the logical AND connection preset switch on the Unit that is on the input side to AND.

The default setting of the logical AND connection preset switch is set to OFF.

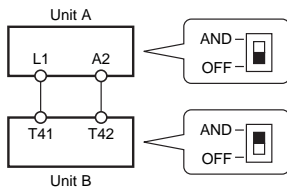

- Note:**
1. A setting error will occur and Unit B will lock out if the logical AND setting switch on Unit B is set to OFF.
 2. Set the logical AND setting switch on Unit A to OFF, otherwise the Unit A output will not turn ON.

6. Setting the OFF-delay Time

The OFF-delay preset time is set from the OFF-delay time preset switch (1 each on the front and back of the Unit).

Normal operation will only occur if both switches are identically set. An error will occur if the switches are not identically set.

The default setting of the OFF-delay time preset switch is set to 0 s.

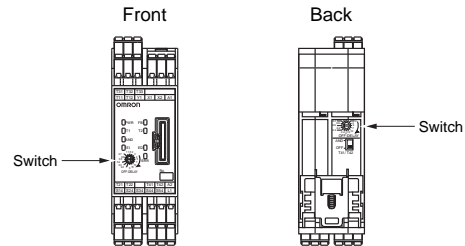

Refer to the following illustration for details on setting switch positions.

G9SX-GS226-T15

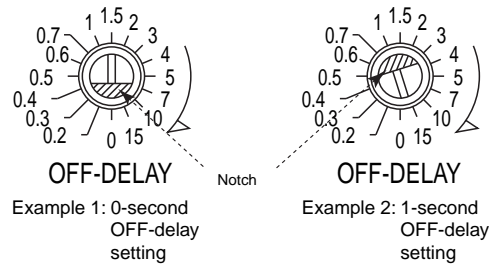

LED Indicators

Marking	Color	Name	G9SX-GS	G9SX-EX	G9SX-EX-T	Function	Reference
PWR	Green	Power supply indicator	○	○	○	Lit while power is supplied.	
T1	Orange	Safety input A, channel 1 indicator	○	---	---	Lit while a HIGH state signal is input to T12. Blinks when an error relating to safety input A channel 1 occurs.	
T2	Orange	Safety input A, channel 2 indicator	○	---	---	Lit while a HIGH state signal is input to T22. Blinks when an error relating to safety input A channel 2 occurs.	
T6	Orange	Safety input B, channel 1 indicator	○	---	---	Lit while a HIGH state signal is input to T62. Blinks when an error relating to safety input B channel 1 occurs.	
T7	Orange	Safety input B, channel 2 indicator	○	---	---	Lit while a HIGH state signal is input to T72. Blinks when an error relating to safety input B channel 2 occurs.	
FB	Orange	Feedback/reset input indicator	○	---	---	Lit in the following cases: <ul style="list-style-type: none"> With automatic reset while a HIGH state signal is input to T33. With manual reset while a HIGH state signal is input to T32. Blinks when an error relating to feedback/reset input occurs.	*
AND	Orange	Logical AND input indicator	○	---	---	Lit while a HIGH state signal is input to T41. Blinks when an error relating to logical AND connection input occurs.	
EI	Orange	Safety output indicator	○	○	---	Lit while the Instantaneous safety outputs (S14, S24) are in the ON-state. Blinks when an error relating to the instantaneous safety output occurs.	
ED	Orange	OFF-delayed safety output indicator	○	---	○	Lit while OFF-delayed safety outputs (S44, S54) are in the ON-state. Blinks when an error relating to OFF-delayed safety output occurs.	
UA	Orange	Safety input A disabled state indicator	○	---	---	Lit while the input of safety input A (T12, T22) is disabled. Blinks when an error relating to the external indicator (UA) occurs.	
UB	Orange	Safety input B disabled state indicator	○	---	---	Lit while the input of safety input B (T62, T72) is disabled. Blinks when an error relating to the external indicator (UB) occurs.	
ERR	Red	Error indicator	○	○	○	Lights or blinks when an error occurs.	

* Refer to "Fault Detection" on the next page for details.

Settings Indication (at Power ON)









Settings for the G9SX-GS□ can be checked by the orange indicators for approx. 3 seconds after the power is turned ON. During this settings indication period, the ERR indicator will light, however the auxiliary error output will remain OFF

Indicator	Item	Setting position	Indicator status	Setting mode	Setting status
T1	Cross fault detection mode for safety input A	Y1 terminal	Lit	Enabled	Y1 = open
			Not lit	Disabled	Y1 = 24 VDC
T6	Cross fault detection mode for safety input B	Y2 terminal	Lit	Enabled	Y2 = open
			Not lit	Disabled	Y2 = 24 VDC
FB	Reset mode	T33 or T32 terminal	Lit	Manual reset mode	T33 = 24 VDC
			Not lit	Auto reset mode	T32 = 24 VDC
AND	Logical AND connection input mode	Logical AND connection preset switch	Lit	Enabled	"AND"
			Not lit	Disabled	"OFF"
UA, UB	Switching Function	Switching Function setting switch	Lit	Manual switching	"Manual"
			Not lit	Auto switching	"Auto"

Fault Detection

When the G9SX-GS□ detects a fault, the ERR indicator and/or other indicators light or blink to inform the user about the fault. Check and take necessary measures referring to the following table, and then re-supply power to the G9SX-GS□.

Safety Guard Switching Unit

ERR indicator	Other indicator	Fault	Expected causes of the fault	Check points and measures to take	
 Blinks	---	Fault due to electro-magnetic disturbance or of internal circuits.	<ol style="list-style-type: none"> Excessive electromagnetic disturbance Failure of the internal circuit 	<ol style="list-style-type: none"> Check the disturbance level around the G9SX-GS□ and the related system. Replace with a new product. 	
 Lights	 T1 blinks	Fault involved with safety input A, channel 1	<ol style="list-style-type: none"> Failure involving the wiring of safety input A channel 1 Incorrect setting of cross fault detection input Failure of the circuit of safety input A channel 1 	<ol style="list-style-type: none"> Check the wiring to T11 and T12. Check the wiring to Y1. Replace with a new product. 	
	 T2 blinks	Fault involved with safety input A, channel 2	<ol style="list-style-type: none"> Failure involving the wiring of safety input A channel 2 Incorrect setting of cross fault detection input Failure of the circuit of safety input A channel 2 	<ol style="list-style-type: none"> Check the wiring to T21 and T22. Check the wiring to Y1. Replace with a new product. 	
	 T6 blinks	Fault involved with safety input B, channel 1	<ol style="list-style-type: none"> Failure involving the wiring of safety input B channel 1 Incorrect setting of cross fault detection input Failure of the circuit of safety input B channel 1 	<ol style="list-style-type: none"> Check the wiring to T61 and T62. Check the wiring to Y2. Replace with a new product. 	
	 T7 blinks	Fault involved with safety input B, channel 2	<ol style="list-style-type: none"> Failure involving the wiring of safety input B channel 2 Incorrect setting of cross fault detection input Failure of the circuit of safety input B channel 2 	<ol style="list-style-type: none"> Check the wiring to T71 and T72. Check the wiring to Y2. Replace with a new product. 	
	 FB blinks		Faults involved with feedback/reset input	<ol style="list-style-type: none"> Failures involving the wiring of feedback/reset input. Failures of the circuit of feedback/reset input 	<ol style="list-style-type: none"> Check the wiring to T31, T32 and T33. Replace with a new product.
			Fault in Expansion Unit	<ol style="list-style-type: none"> Improper feedback signals from Expansion Unit Abnormal supply voltage to Expansion Unit Failure of the circuit of safety relay contact outputs 	<ol style="list-style-type: none"> Check the connecting cable of Expansion Unit and the connection of the terminating connector Check the supply voltage to Expansion Unit. Note: Make sure that all Expansion units' PWR indicators are lit. Replace the Expansion Unit with a new one.
	 EI blinks		Fault involved with instantaneous safety outputs or logical AND connection outputs	<ol style="list-style-type: none"> Failure involving the wiring of instantaneous safety outputs Failure of the circuit of Instantaneous safety outputs Failure involving the wiring of the logical AND connection output Failure of the circuit of the logical AND connection output Impermissible high ambient temperature 	<ol style="list-style-type: none"> Check the wiring to S14 and S24. Replace with a new product. Check the wiring to L1. Replace with a new product. Check the ambient temperature and spacing around the G9SX-GS□.
	 ED blinks		Fault involved with OFF-delayed safety outputs	<ol style="list-style-type: none"> Failure involving the wiring of OFF-delayed safety relay contact outputs Incorrect set values for OFF-delay time Failure of the circuit of OFF-delayed safety relay contact outputs Impermissible high ambient temperature 	<ol style="list-style-type: none"> Check the wiring to S44 and S54. Confirm the set values of the OFF-delay time preset switches on the front and back of the Unit. Replace with a new product. Check the ambient temperature and spacing around the G9SX-GS□.

ERR indicator	Other indicator	Fault	Expected causes of the fault	Check points and measures to take
● Lights	☀ AND blinks	Fault involved with logical AND connection input	1) Failure involving the wiring of the logical AND connection input 2) Incorrect setting for the logical AND connection input 3) Failure of the circuit of the logical AND connection input	1) Check the wiring to T41 and T42. Note: Make sure that the wiring length for the T41, T42 terminal is less than 100 meters. Note: Make sure that the logical AND connection signal is branched for less than 4 units. 2) Confirm the set value of the logical AND connection preset switch. 3) Replace with a new product.
	☀ UA blinks	Fault involved with the external indicator output (UA)	1) Failure involving the wiring of the external indicator output 2) Failure involving the wiring of the external indicator diagnosis switching input 3) Failure of the circuit of the external indicator output 4) Failure of the external indicator	1) Check the wiring to UA. 2) Check the wiring to Y3. Note: When no indicator is connected, or an LED indicator is connected, connect Y3 to 24 V. 3) Replace with a new product. 4) Replace the connected external indicator.
	☀ UB blinks	Fault involved with the external indicator output (UB)	1) Failure involving the wiring of the external indicator output 2) Failure involving the wiring of the external indicator diagnosis switching input 3) Failure of the circuit of the external indicator output 4) Failure of the external indicator	1) Check the wiring to UB. 2) Check the wiring to Y4. Note: When no indicator is connected, or an LED indicator is connected, connect Y4 to 24 V. 3) Replace with a new product. 4) Replace the connected external indicator.
	☀ UA and UB alternately blink	Fault involved with the Switching Function	1) Failure involving the setting of the Switching Function setting switch 2) Failure involving the wiring of the mode selector input 3) Failure involving the circuit of the mode selector input 4) Failure involving the mode selector switching time	1) Check the setting of the Switching Function setting switch. 2) Check the wiring to M1 and M2. 3) Replace with a new product. 4) Check the signal switching time of the mode selector input (M1, M2).
	☀ All indicators except PWR blink	Supply voltage outside the rated value	1) Supply voltage outside the rated value	1) Check the supply voltage to the Units.

When indicators other than the ERR indicator blink, check and take necessary actions referring to the following table.

ERR indicator	Other indicators	Fault	Expected cause of the fault	Check points and measures to take
○ Off	T1	Safety input A mismatch	The input status between safety input A channel 1 and safety input A channel 2 is different, due to contact failure or a short circuit of safety input device(s) or a wiring fault.	Check the wiring from safety input devices to the G9SX-GS□. Or check the input sequence of safety input devices. After removing the fault, turn both safety input A channels 1 and 2 to the OFF state.
	T2			
	T6	Safety input B mismatch	The input status between safety input B channel 1 and safety input B channel 2 is different, due to contact failure or a short circuit of safety input device(s) or a wiring fault.	Check the wiring from safety input devices to the G9SX-GS□. Or check the input sequence of safety input devices. After removing the fault, turn both safety input B channels 1 and 2 to the OFF state.
	T7			

(Expansion Unit)

ERR indicator	Other indicators	Fault	Expected cause of the faults	Check points and measures to take
● Lights	---	Fault involved with safety relay outputs of Expansion Units	1) Welding of relay contacts 2) Failure of the internal circuit	Replace with a new product.

G9SX-GS

Dimensions and Terminal Arrangement

(Unit: mm)

Safety Guard Switching Unit

G9SX-GS226-T15-□

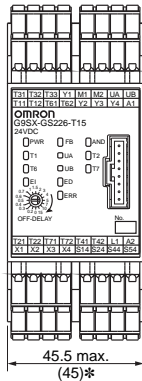
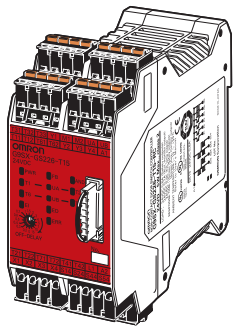

* Typical dimension

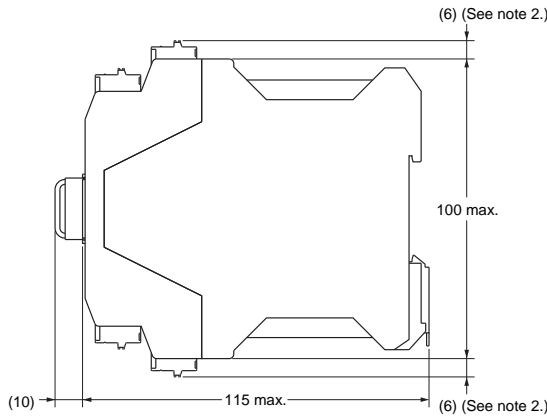

Terminal arrangement

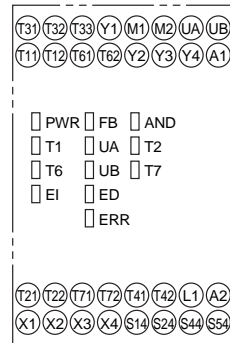

Note: 1. Above outline drawing is for -RC terminal type.
2. For -RC terminal type only.

Expansion Unit

G9SX-EX401-□

Expansion Unit (OFF-delayed Model)

G9SX-EX041-T-□

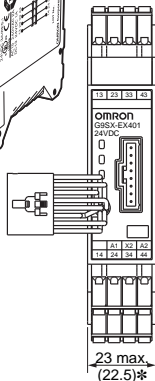
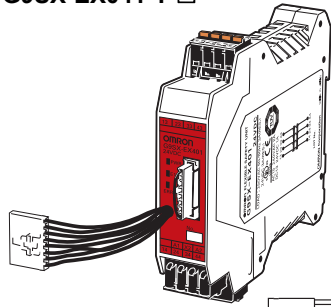

* Typical dimension

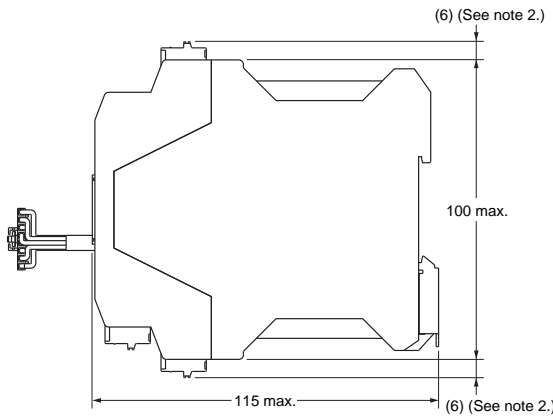

Terminal arrangement

G9SX-EX401-□ (Expansion Unit)

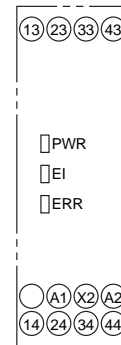

G9SX-EX041-T-□ (Expansion Unit with OFF Delay)

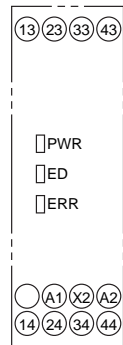

Note: 1. Above outline drawing is for -RC terminal type.
2. For -RC terminal type only.

Application Examples

Highest achievable PL/ safety category	Model	Stop category	Reset
PL _e /4 equivalent	Emergency Stop Switch A165E/A22E Flexible Safety Unit G9SX-BC202 Safety Light Curtain F3SJ-B/F3SJ-E/F3SJ-A Flexible Safety Unit G9SX-GS226-T15	M1, M2: 0	Emergency Stop: Manual Safety Light Curtain: Auto

Note: The above PL is only the evaluation result of the example. The PL must be evaluated in an actual application by the customer after confirming the usage conditions.

● Application Overview 1

- When the emergency stop switch S1 is pressed.
 - The power supply to the motor M1 and M2 is turned OFF immediately when the emergency stop switch S1 is pressed.
 - The power supply to the motor M1 is kept OFF until the reset switch S2 is pressed while the emergency stop switch S1 is released.
 - The power supply to the motor M2 is kept OFF until one of the safety light curtains 1 and 2 is unblocked and the reset switch S2 is pressed while the emergency stop switch S1 is released.
- When the operator and robot block the beams at the same time.
 - The power supply to the motor M2 is turned OFF immediately when both beams are blocked. (The power supply to the motor M1 is kept ON.)
 - The power supply to the motor M2 is kept OFF until one of the safety light curtains 1 and 2 is unblocked.

- Note:**
- Diagnostic checks of the external indicators connected to external indicator outputs UA and UB can be switched with Y3 and Y4, respectively.
 - Use safety light curtains with PNP control outputs.

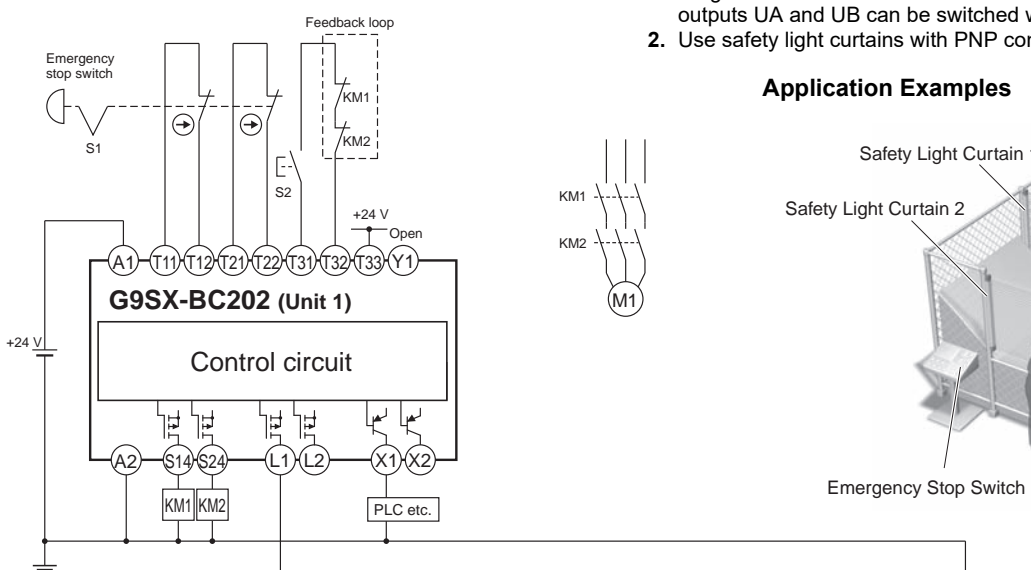

Application Examples

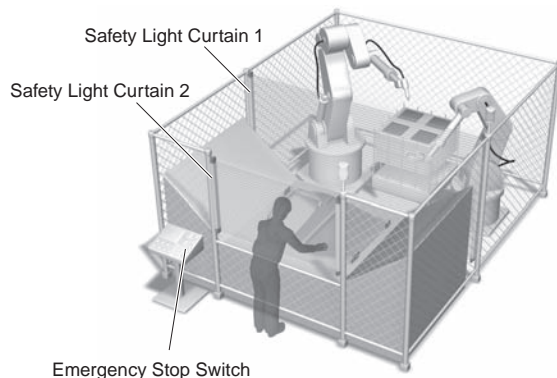

S1: Emergency stop switch
S2: Reset switch
KM1 to KM4: Magnetic contactors
M1 and M2: Motors

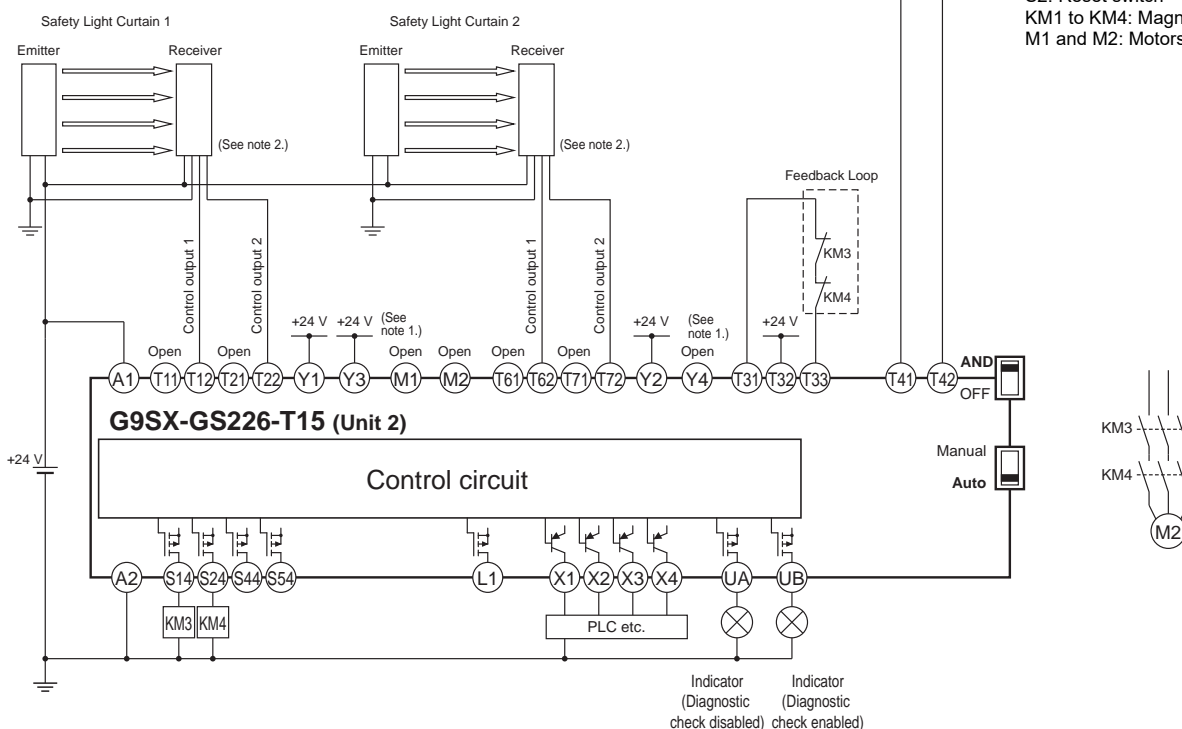

Timing Chart 1

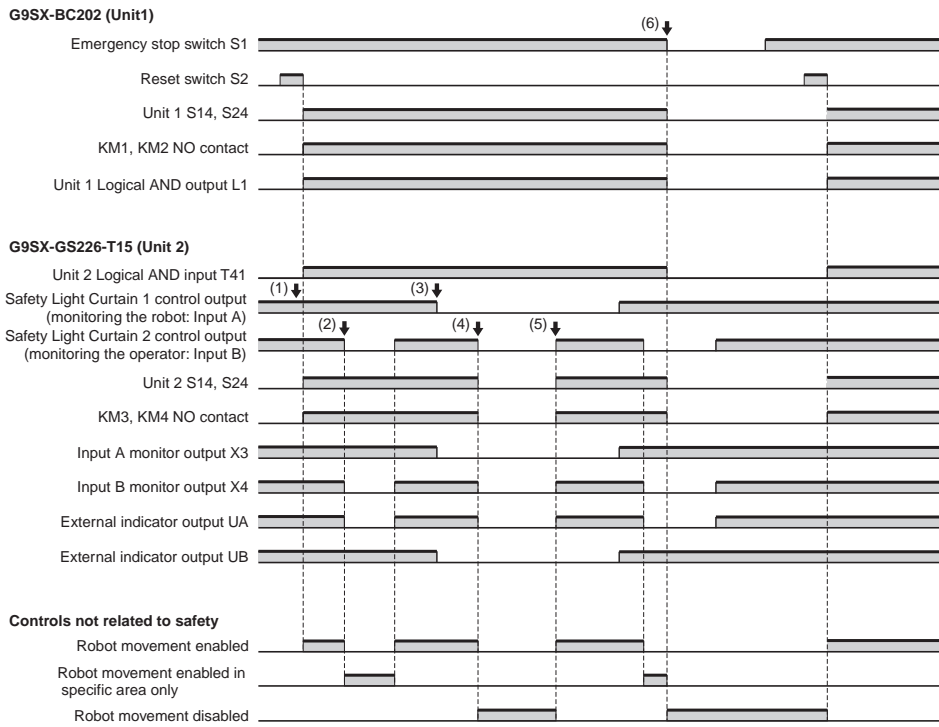

- (1) Prior to operation start
- (2) Operator inserts workpiece
- (3) Robot processes workpiece
- (4) Both operator and robot enter the coordinated area: Only Unit 2 stops.
- (5) Unit 2 restarts.
- (6) Emergency stop switch pressed: All units stop.

Highest achievable PL/ safety category	Model	Stop category	Reset
PL _e /4 equivalent	Emergency Stop Switch A165E/A22E Flexible Safety Unit G9SX-BC202 Safety Limit Switch D4B-N/D4N/D4F Guard Lock Safety-door Switch D4NS/D4GS-N/D4BS Safety Key Selector Switch A22TK Flexible Safety Unit G9SX-GS226-T15	M1, M2: 0	Manual

Note: The above PL is only the evaluation result of the example. The PL must be evaluated in an actual application by the customer after confirming the usage conditions.

● Application Overview 2

1. Normal operating mode (When the mode M1 of the G9SX-GS is turned ON.)

Normal operating mode (M1 = ON, M2 = OFF) is selected on the selector switch S7. The enabling switch S3 and S4 for detecting the conveyor cart position are disabled.

1-1. When the emergency stop switch S1 is pressed.

- The power supply to the motor M1 and M2 is turned OFF immediately when the emergency stop switch S1 is pressed.
- The power supply to the motor M1 is kept OFF until the reset switch S2 is pressed while the emergency stop switch S1 is released.
- The power supply to the motor M2 is kept OFF until the reset switch S2 and S8 are pressed while the guard is closed and the emergency stop switch S1 is released.

1-2. When the guard is opened (the emergency stop switch S1 is released).

- The power supply to the motor M2 is turned OFF immediately when the S5 and S6 detect that the guard is opened. (The power supply to the motor M1 is kept ON.)
- The power supply to the motor M2 is kept OFF until the guard is closed and the reset switch S8 is pressed.

2. Maintenance mode (When the mode M2 of the G9SX-GS is turned ON.)

Maintenance mode (M1 = OFF, M2 = ON) is selected on the selector switch S7. The S5 to detect the opening and closing of the guard is disabled.

2-1. When the emergency stop switch S1 is pressed.

- The power supply to the motor M1 and M2 is turned OFF immediately when the emergency stop switch S1 is pressed.
- The power supply to the motor M1 is kept OFF until the reset switch S2 is pressed while the emergency stop switch S1 is released.
- The power supply to the motor M2 is kept OFF until the reset switch S2 and S8 are pressed while the conveyor cart is at the safety position and safety limit switch S3 and S4 are turned ON and the emergency stop switch S1 is released.

2-2. When the conveyor cart moves away from its safe position (the emergency stop switch S1 is released).

- The power supply to the motor M2 is turned OFF after the conveyor cart moving away from the safety position and the safety limit switch S3 and S4 being turned OFF. (The power supply to the motor M1 is kept ON.)
- The power supply to the motor M2 is kept OFF until the reset switch S8 is pressed after the conveyor cart returning to the safety position and the safety limit switch S3 and S4 being turned ON.

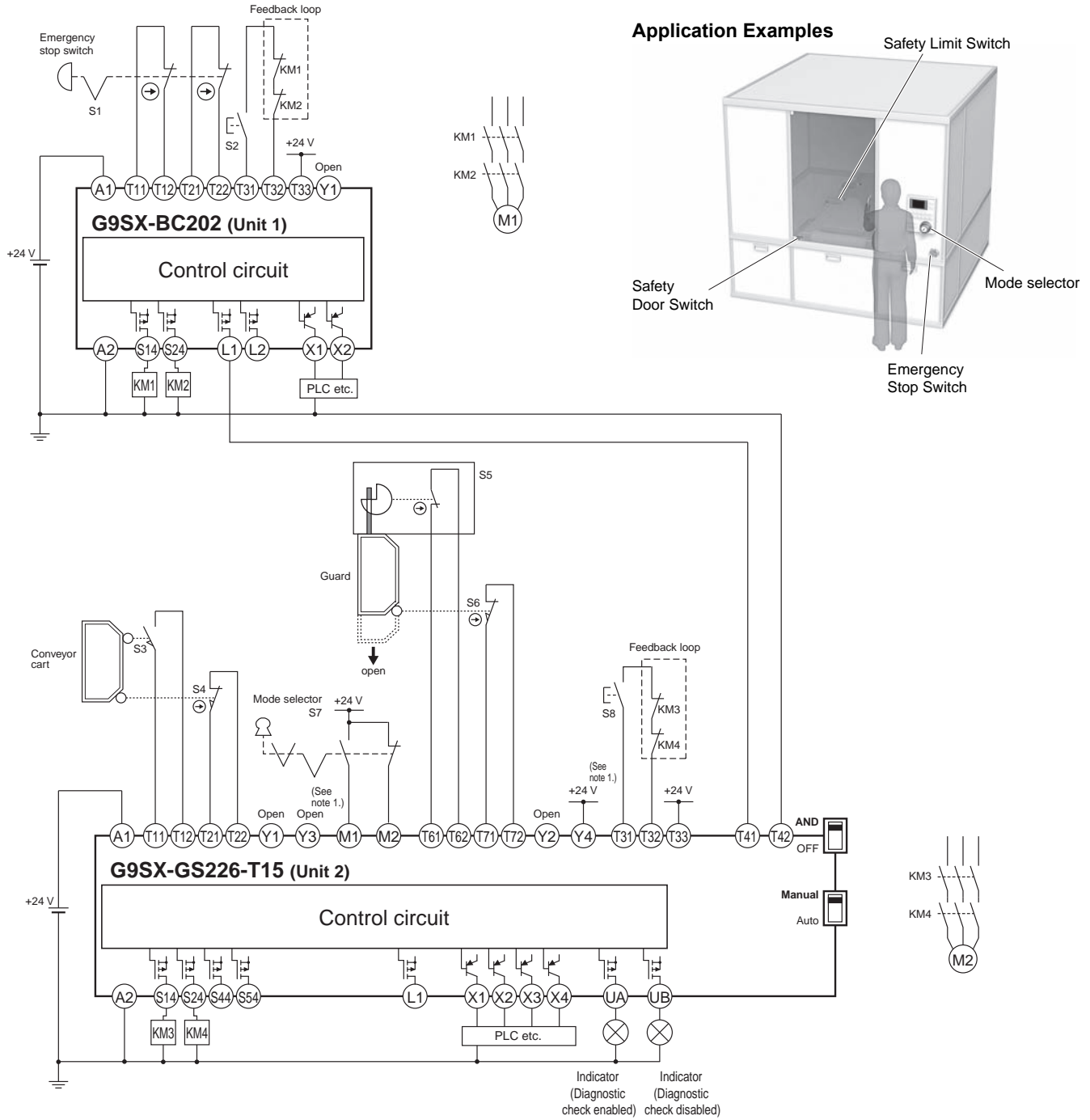

- S1: Emergency Stop Switch
- S2, S8: Reset Switches
- S3: Limit Switch
- S4, S6: Safety Limit Switches
- S5: Safety Door Switch
- S7: Safety Key Selector Switch
- KM1 to KM4: Magnetic Contactors
- M1 and M2: Motors

Note: Diagnostic checks for the external indicators connected to external indicator outputs UA and UB can be switched with Y3 and Y4, respectively.

Timing Chart 2

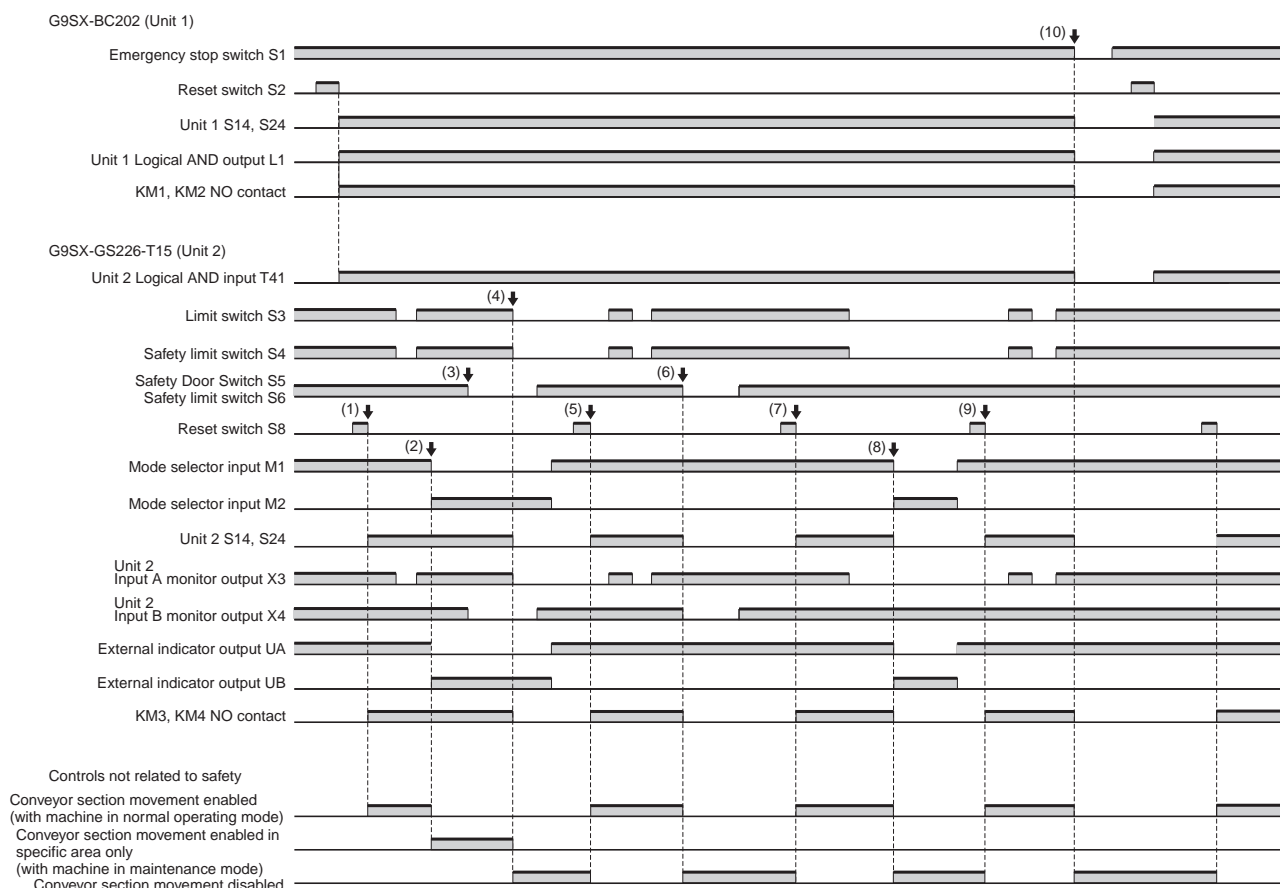

- (1) Start Unit 2 in normal operating mode.
- (2) Use the selector switch to change to maintenance mode when the conveyor cart is at the safety position.
- (3) The operator opens the guard and performs maintenance.
- (4) When Safety Limit Switch S3 and Limit Switch S4 are turned OFF in maintenance mode, Unit 2 stops.
- (5) After the guard is closed and the operating mode is switched to normal operating mode, restart Unit 2.
- (6) When the guard is opened during normal operating mode, Unit 2 stops.
- (7) Close the guard and restart Unit 2.
- (8) When the operating mode is switched to maintenance mode while Safety Limit Switch S3 and Limit Switch S4 are turned OFF, Unit 2 stops.
- (9) Switch to normal operating mode, and when the guard is closed, restart Unit 2.
- (10) Emergency stop switch pressed: All units stop.

Note: 1. In this example, press reset switch S2, confirm that Unit 1 has started operating, then press reset switch S8.
 2. To use the set value of the mode selector for control, use external indicator output UA for control and external indicator output UB for the operator's indication. In this case, disable the diagnostic check of the external indicator output UA.

G9SX-AD□/BC/EX

G9SX-GS

G9SX-AD□/BC/EX,
G9SX-GS Common

G9SX-SM

G9SX-NS

Highest achievable PL/ safety category	Model	Stop category	Reset
PLe/4 equivalent	Emergency Stop Switch A165E/A22E Flexible Safety Unit G9SX-BC202 Safety Limit Switch D4B-N/D4N/D4F Guard Lock Safety-door Switch D4NS/D4GS-N/D4BS Safety Key Selector Switch A22TK Flexible Safety Unit G9SX-GS226-T15 Flexible Safety Unit G9SX-AD322-T15	M1, M2, M3: 0	Manual

Note: The above PL is only the evaluation result of the example. The PL must be evaluated in an actual application by the customer after confirming the usage conditions.

● Application Overview 3

1. When the emergency stop switch S1 is pressed.

- The power supply to the motor M1, M2, and M3 is turned OFF immediately when the emergency stop switch S1 is pressed.
- The power supply to the motor M1 is kept OFF until the reset switch S2 is pressed while the emergency stop switch S1 is released.
- The power supply to the motor M2 is kept OFF until the reset switch S2 and S8 are pressed while the guard 1 is closed and the emergency stop switch S1 is released.
- The power supply to the motor M3 is kept OFF until the reset switch S2 and S11 are pressed while the guard 2 is closed and the emergency stop switch S1 is released.

2. When the guard 2 is opened (the emergency stop switch S1 is released).

- The power supply to the motor M3 is turned OFF immediately when the S9 and S10 detect that the guard 2 is opened. (The power supply to the motor M1 and M2 is kept ON.)
- The power supply to the motor M3 is kept OFF until the guard 2 is closed and the reset switch S11 is pressed.

3-1. Normal operating mode (When the mode M1 of the G9SX-GS is turned ON.)

Normal operating mode (M1 = ON, M2 = OFF) is selected on the selector switch S7. The safety limit switch S3 and S4 to detect the conveyor cart position are disabled.

- The power supply to the motor M2 is turned OFF immediately when the S5 and S6 detect that the guard 1 is opened. (The power supply to the motor M1 and M3 is kept ON.)
- The power supply to the motor M2 is kept OFF until the guard 1 is closed and the reset switch S8 is pressed.

3-2. Maintenance mode (When the mode M2 of the G9SX-GS is turned ON.)

Maintenance mode (M1 = OFF, M2 = ON) is selected on the selector switch S7. The S5 and S6 to detect the opening and closing of the guard 1 are disabled.

- The power supply to the motor M2 is turned OFF after the conveyor cart moving away from the safety position and the safety limit switch S3 and S4 being turned OFF. (The power supply to the motor M1 and M3 is kept ON.)
- The power supply to the motor M2 is kept OFF until the reset switch S8 is pressed after the conveyor cart returning to the safety position and the safety limit switch S3 and S4 being turned ON.

Application Examples

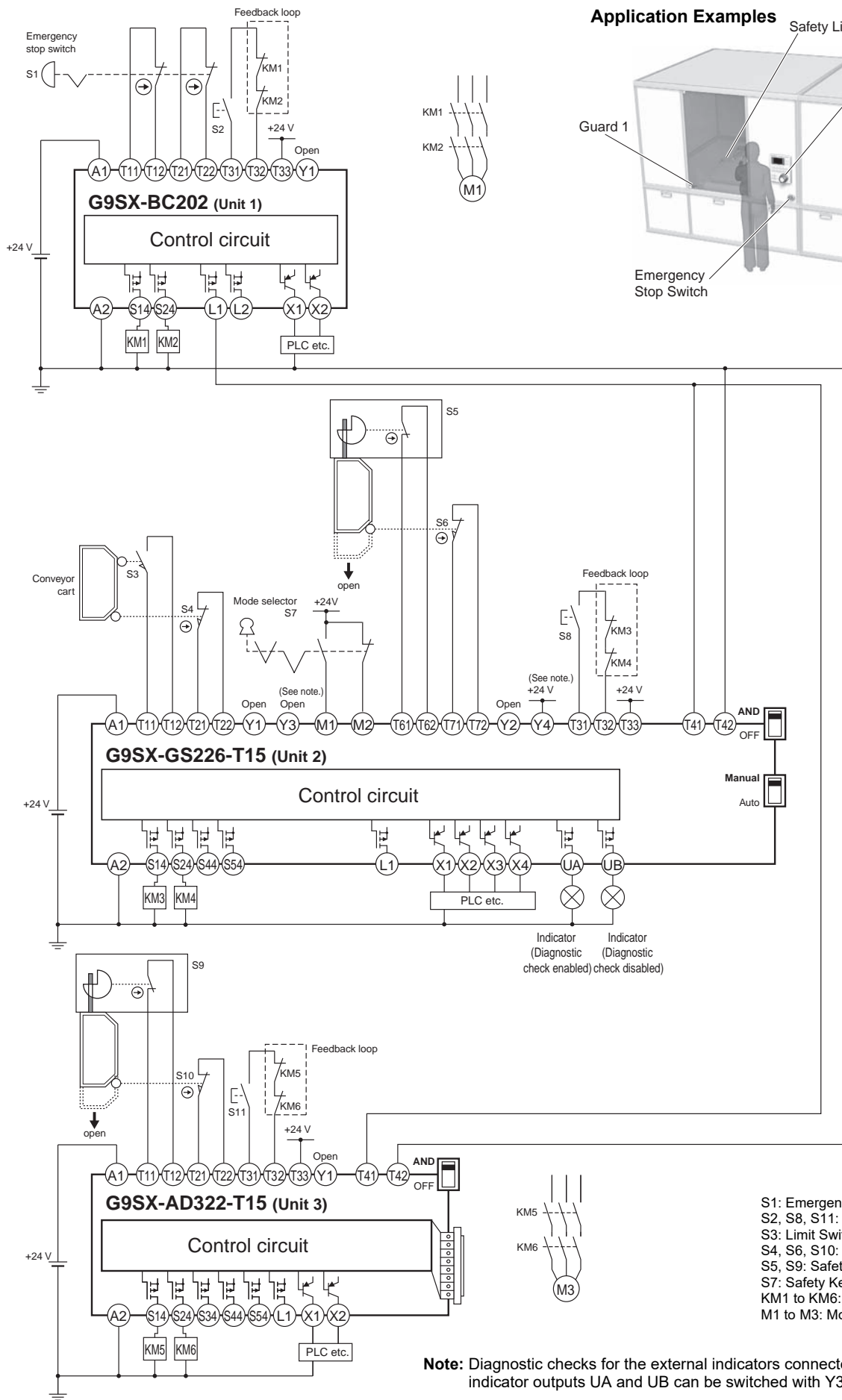
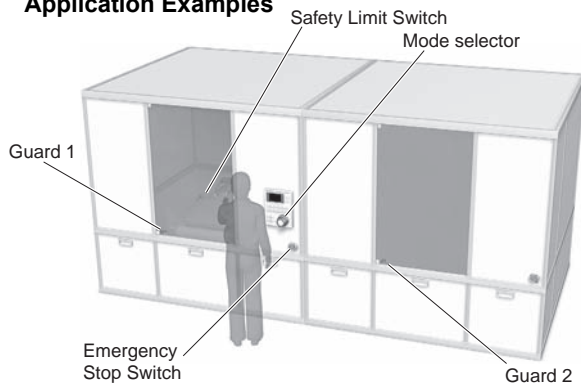

- S1: Emergency Stop Switch
- S2, S8, S11: Reset Switches
- S3: Limit Switch
- S4, S6, S10: Safety Limit Switches
- S5, S9: Safety Door Switches
- S7: Safety Key Selector Switch
- KM1 to KM6: Magnetic Contactors
- M1 to M3: Motors

Note: Diagnostic checks for the external indicators connected to external indicator outputs UA and UB can be switched with Y3 and Y4 respectively.

Timing Chart 3

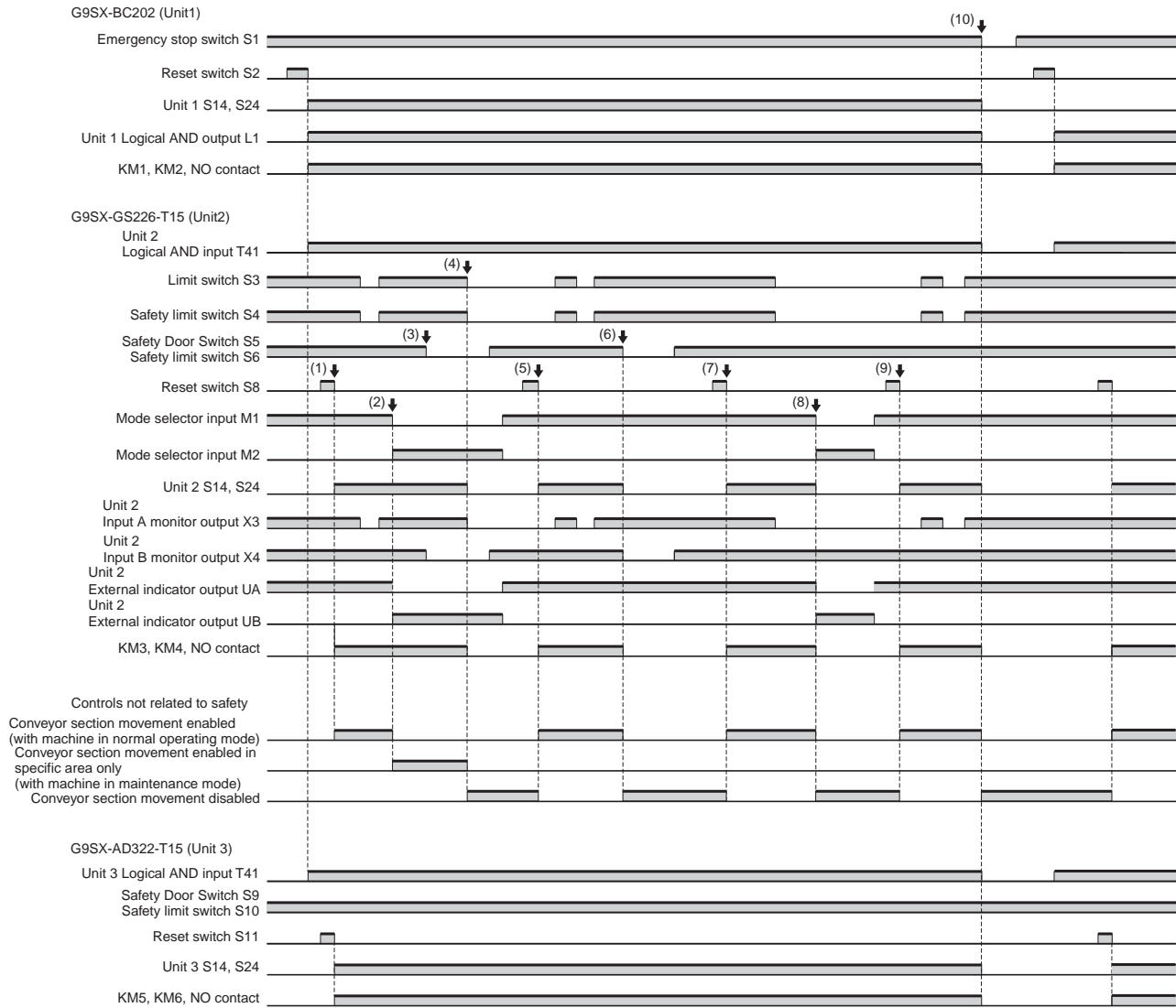

- (1) Start Unit 2 in normal operating mode.
- (2) Use the selector switch to change to maintenance mode when the conveyor cart is at the safety position.
- (3) The operator opens the guard 1 and performs maintenance.
- (4) When Safety Limit Switch S3 and Limit Switch S4 are turned OFF in maintenance mode, Unit 2 stops.
- (5) After the guard 1 is closed and the operating mode is switched to normal operating mode, restart Unit 2.
- (6) When the guard 1 is opened during normal operating mode, Unit 2 stops.
- (7) Close the guard 1 and restart Unit 2.
- (8) When the operating mode is switched to maintenance mode while Safety Limit Switch S3 and Limit Switch S4 are turned OFF, Unit 2 stops.
- (9) Switch to normal operating mode, and when the guard 1 is closed, restart Unit 2.
- (10) Emergency stop switch pressed: All units stop.

- Note:**
1. In this example, press reset switch S2, confirm that Unit 1 has started operating, then press reset switch S8 and S11.
 2. To use the set value of the mode selector for control, use external indicator output UA for control and external indicator output UB for the operator's indication. In this case, disable the diagnostic check of the external indicator output UA.

Safety Precautions

Be sure to read the *Common Precautions for Safety Warning* at the following URL: <http://www.ia.omron.com/>.

Indication and Meaning for Safe Use

⚠ WARNING	Indicates a potentially hazardous situation which, if not avoided, will result in minor or moderate injury, or may result in serious injury or death. Additionally there may be significant property damage.
Precautions for Safe Use	Supplementary comments on what to do or avoid doing, to use the product safely.
Precautions for Correct Use	Supplementary comments on what to do or avoid doing, to prevent failure to operate, or undesirable effect on product performance.

⚠ WARNING

<Precautions for All G9SX Models>

Serious injury may possibly occur due to breakdown of safety outputs.
Do not connect loads beyond the rated value to the safety outputs.

Serious injury may possibly occur due to loss of required safety functions.
Wire the G9SX properly so that the safety outputs do not short-circuit with the Unit power supply or load power supply.

Serious injury may possibly occur due to malfunction of safety outputs.
Add a circuit to protect against back electromotive force when connecting inductive loads to safety outputs.

Serious injury may possibly occur due to loss of safety functions. Use appropriate devices as given in the following table.

Control Devices	Requirements
Door interlocking switches or Safety limit switches	Use approved devices with Direct Opening Mechanism complying with IEC/EN 60947-5-1 and capable of switching micro loads of 24 VDC, 5 mA.
Safety sensors	Use approved devices complying with the relevant product standards, regulations and rules in the country where it is used. Consult a certification body to assess that the entire system satisfies the required safety category level.
Relays with forcibly guided contacts	Use approved devices with forcibly guided contacts complying with IEC 61810-3 (EN 50205). For feedback purpose use devices with contacts capable of switching micro loads of 24 VDC, 5 mA.
Contactors	Use approved devices complying with IEC/EN 60947-4-1 auxiliary contact linked with power contact (mirror contact). For feedback purpose use devices with contacts capable of switching micro loads of 24 VDC, 5 mA.
Emergency stop switches	Use approved devices with Direct Opening Mechanism complying with IEC/EN 60947-5-1 Do not connect an emergency stop switch to the G9SX-GS□.
Other devices	Evaluate whether devices used are appropriate to satisfy the requirements of safety category level.

<G9SX-GS□>

Serious injury may possibly occur due to loss of safety functions. Construct an appropriate safety system as shown in the following table.

Switching function	Auto switching
Safety system configuration example	
Safety precautions	<ol style="list-style-type: none"> Select Safety Sensors that satisfy the following condition: Diameter of the smallest detectable object < Diameter of the object to be detected Install the Safety Sensors so that they satisfy the following conditions: (1) Use Safety Sensor A to detect the entry of the machine into area A, and Safety Sensor B to detect the entry of a person into area A. (2) Make sure that the machine can reach area A only by passing through Safety Sensor A, and that a person can reach area A only by passing through Safety Sensor B. Provide a protective structure to prevent a person from passing completely through Safety Sensor B and stepping into area A. If this is not possible, install a sensor that will detect the presence of a person inside area A and prevent the machine from being restarted while the person is inside area A. Provide a sufficient safety distance (S1) considering the entry speed of a person and a sufficient safety distance (S2) considering the entry speed of the machine. For details, refer to "Safety Distance" on page 46.

Switching function	Manual switching
Safety system configuration example	
Safety precautions	<ol style="list-style-type: none"> Select Safety Sensors that satisfy the following condition: Diameter of the smallest detectable object < Diameter of the object to be detected Install the Safety Sensors so that they satisfy the following conditions: (1) Use the Safety Sensor to detect the entry of the machine into area A. (2) Make sure that the machine can reach area A only by passing through the Safety Sensor. Provide a protective structure to prevent a person from stepping into area A when the door is opened. If this is not possible, install a sensor that will detect the presence of a person inside area A and prevent the machine from being restarted while the person is inside area A. Provide a sufficient safety distance (S2) considering the entry speed of the machine. For details, refer to "Safety Distance" on page 46. Position the mode selector in a location where it cannot be operated from inside area A.

Safety Distance

The safety distance is the minimum distance that must be provided between the safety input device and a machine's hazardous part to stop the hazardous part before a person or object reaches it. The safety distance varies according to the standards of each country and the specifications of each machine. In addition, the calculation of the safety distance differs if the direction of approach is not perpendicular to the detection zone of the safety input device. Always refer to the relevant standards.

Safety Distance Concepts

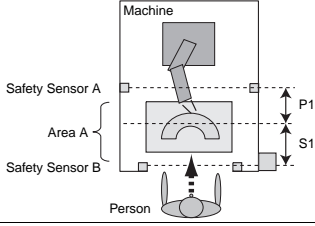
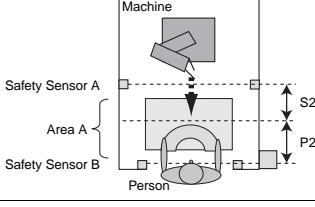
<p>When a person approaches a hazard (machine)</p>	 <ul style="list-style-type: none"> • S1: Safety distance 1 • P1: The closest that a machine can come to a person while operating (the boundary of the machine's operating area)
<p>When a hazard (machine) approaches a person</p>	 <ul style="list-style-type: none"> • S2: Safety distance 2 • P2: The closest that a part of a person can come to a machine.

Safety Distance Calculation Examples (Reference)

<p>Calculating the safety distance specified by international standard ISO 13855</p>	<p>If a person approaches the detection zone perpendicularly, calculate the safety distance as shown below.</p> $S1 = K1 \times T + C$ $S2 = K2 \times T + C$ <p>S1: Safety distance 1 S2: Safety distance 2 K1: Approach speed of a person to the detection zone (area A) K2: Maximum approach speed of a machine to the detection zone (area A) T: Total response time of the machine and G9SX system C: Additional distance calculated by the detection capability (the diameter of the smallest detectable object) of the Safety Sensor.</p>
<p>Calculating the safety distance specified by American standard ANSI B11.19</p>	<p>If a person approaches the detection zone perpendicularly, calculate the safety distance as shown below.</p> $S1 = K1 \times (Ts + Tc + Tr + Tspm) + Dpf$ $S2 = K2 \times (Ts + Tc + Tr + Tspm) + Dpf$ <p>S1: Safety distance 1 S2: Safety distance 2 K1: Approach speed of a person to the detection zone (area A) K2: Maximum approach speed of a machine to the detection zone (area A) Ts: Machine's stop time (s) Tr: Response time of the G9SX system from ON to OFF (s) Tc: Machine control circuit's maximum response time required to activate its brake (s) Tbm: Additional time (s) Dpf: Additional distance</p>

1. To determine the approach speed K1, consider all factors, including the operator's physical abilities.
2. To determine the maximum approach speed K2, consult with a notified body or other authoritative institutes.
3. The response time of a machine is the time from when the machine receives a stop signal to the time when the machine's hazardous part stops. Measure the response time on the actual system. Also, periodically check that the machine's response time has not changed.
4. For information on the response time of the G9SX system, refer to item 10 of "Precautions for Correct Use" on page 47.

Precautions for Safe Use

<Precautions for All G9SX Models>

1. Use G9SX within an enclosure with IP54 protection or higher of IEC60529.
2. Incorrect wiring may lead to loss of safety function. Wire conductors correctly and verify the operation of G9SX before commissioning the system in which G9SX is incorporated.
3. Do not apply DC voltages exceeding the rated voltages, or any AC voltages to the G9SX power supply input. Do not connect to DC distribution network.
4. Use DC supply satisfying requirements below to prevent electric shock.
 - DC power supply with double or reinforced insulation, for example, according to IEC/EN60950 or EN50178 or a transformer according to IEC/EN61558.
 - DC supply satisfies the requirement for class 2 circuits or limited voltage/current circuit stated in UL 508.
5. Apply properly specified voltages to G9SX inputs. Applying inappropriate voltages cause G9SX to fail to perform its specified function, which leads to the loss of safety functions, damages to G9SX, or burning.
6. Auxiliary error outputs and auxiliary monitoring outputs are NOT safety outputs. Do not use auxiliary outputs as any safety output. Such incorrect use causes loss of safety function of G9SX and its relevant system. Also Logical AND connection outputs can only be used for logical AND connections between G9SXs.
7. After installation of G9SX, qualified personnel should confirm the installation, and should conduct test operations and maintenance. The qualified personnel should be qualified and authorized to secure the safety on each phases of design, installation, running, maintenance and disposal of system.
8. A person in charge, who is familiar to the machine in which G9SX is to be installed, should conduct and verify the installation.
9. Inspect the G9SX daily and every six months. Incorrect system operation may result in serious injury.
10. Do not dismantle, repair, or modify G9SX. It may lead to loss of its safety functions, creating a dangerous situation.
11. Use only appropriate components or devices complying with relevant safety standards corresponding to the required level of safety categories. Conformity to requirements of safety category is determined as an entire system. It is recommended to consult a certification body regarding assessment of conformity to the required safety level.
12. OMRON shall not be responsible for conformity with any safety standards regarding to customer's entire system.
13. Disconnect G9SX from power supply when wiring, to prevent electric shock or unexpected operation.
14. Be cautious not to have your fingers caught when attaching terminal sockets to the plugs on G9SX.
15. Do not use in combustible gases or explosive gases.

<G9SX-GS□>

1. Be sure to correctly connect safety input devices to safety input A and safety input B to ensure proper operation of the safety functions.
2. When setting the Switching Function, be sure to consider safety control requirements, safety level and safety category of the entire system.
3. A qualified personnel who has a thorough understanding of the installed machine must switch the mode selector input. For example, a Switching Unit with Key must be used for the mode selector, and the key must be managed and used in such a way that the machine cannot be operated by unauthorized persons.

<G9SX-EX□>

1. The durability of relays depend greatly on the switching condition. Confirm the actual conditions of operation in which the relay will be used in order to make sure of the permissible number of switching operations.

Precautions for Correct Use

<Precautions for All G9SX Models>

1. Handle with care
Do not drop G9SX to the ground or expose to excessive vibration or mechanical shocks. G9SX may be damaged and may not function properly.
2. Conditions of storage
G9SX may be damaged and may not function properly. Do not store in such conditions stated below.
 1. In direct sunlight
 2. At ambient temperatures out of the range of -10 to 55°C.
 3. At relative humidity out of the range of 25% to 85% or under such temperature change that causes condensation.
 4. In corrosive or combustible gases
 5. With vibration or mechanical shocks out of the rated values.
 6. Under splashing of water, oil, chemicals
 7. In the atmosphere containing dust, saline or metal powder.
3. Mounting
Mount G9SX to DIN track with attachments (PFP-M, not incorporated to this product), not to drop off the track by vibration or other force especially when the length of DIN track is short compared to the widths of G9SX.
4. Following spacing around G9SX should be available to apply rated current to outputs of G9SX and for enough ventilation and wiring:
 1. At least 25 mm beside side faces of the G9SX.
 2. At least 50 mm above top face of G9SX and below bottom face of G9SX.

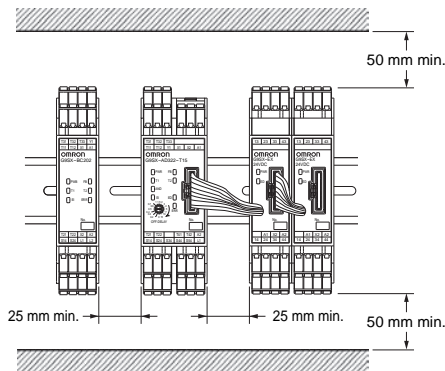

5. Wiring
 - (1) G9SX
 - Wire the G9SX as described below.

Solid wire	0.2 to 2.5 mm ² (AWG24 to AWG12)
Stranded wire	0.2 to 2.5 mm ² (AWG24 to AWG12)

- Strip no more than 7 mm of insulation from the end of the wire.
- (2) G9SX-□-RT (with Screw Terminals)
 - Tighten each screw to 0.5 to 0.6 N·m or the G9SX-□-RT may malfunction or generate heat.
 - (3) Wiring for a Logical AND Connection
 - Use a 2-conductor cable or shielded cable to wire a logical AND connection between Units.

6. Connecting Expansion Units (G9SX-EX□-□):
(Only G9SX-AD□/-ADA□/-NSA□/-GS□)

- (1) Remove the termination connector from the G9SX, and insert the connector of the Expansion Unit into the G9SX to connect it.
- (2) Insert the termination connector into the last Expansion Unit as viewed from the G9SX. When the G9SX is used without any Expansion Units, do not remove the termination connector from the G9SX.
- (3) Do not remove the termination connector while the system is operating.
- (4) Before applying the power supply voltage, confirm that the connecting sockets and plugs are locked.
- (5) Make sure that all connected Expansion Units are supplied with power within 10 s after the power to the G9SX is turned ON. Otherwise, the G9SX will detect a power supply error for the Expansion Units.

7. Use cables with a length of 100 m maximum to connect the safety inputs, feedback/reset input, logical AND connection input, logical AND connection output, or mode selector inputs.
8. Set the time duration of OFF-delay to an appropriate value that does not cause the loss of safety function of system.

9. Logical AND connection between Units
 1. When using Logical AND connection inputs, set the Logical AND connection preset switch to 'AND' position for the units which the logical AND connection signal are input to.
 2. Connect Logical AND connection outputs appropriately to Logical AND connection inputs of the relevant unit. Verify the operation of G9SX before commissioning the system.
 3. Give careful consideration to the response time delay during logical AND connection in order to prevent any reduction in the safety of the safety control system.
 4. Use two-conductor cable or shielded cable for wiring the logical AND connections between Units.

10. To determine the safety distance to hazards, take into account the delay of safety outputs caused by the following times:

- (1) Response time of safety inputs
- (2) Response time of logical AND connection input
(Also consider the precaution in “*” below)
- (3) Preset OFF-delay time
- (4) Accuracy of OFF-delay time

* When connecting multiple Units with logical AND connections, the operating time and response time after logical AND connection inputs will be the sum of the operating times and response times of the Units that are connected in series by logical AND connections.

11. Start entire system after more than 5 s have passed since applying supply voltage to all G9SXs in the system.
12. Power Supply
 - (1) The G9SX may malfunction due to electromagnetic disturbances. Be sure to connect terminal A2 to ground.
 - (2) When sharing a power supply with a Safety Light Curtain, use a power supply that will not fail for a momentary power interruption of 20 ms or less.
13. Devices connected to G9SX may operate unexpectedly. When replacing G9SX, disconnect it from power supply.
14. Adhesion of solvent such as alcohol, thinner, trichloroethane or gasoline on the product should be avoided. Such solvents make the marking on G9SX illegible and cause deterioration of parts.
15. Do NOT mix AC load and DC load to be switched in one G9SX-EX□-□. When switching of both AC load and DC load is necessary, connect more than two G9SX-EX□-□ and use each unit for AC load and DC load exclusively.
16. Operate the reset input more than 0.4 seconds immediately after the safety outputs are OFF.
G9SX does not accept the reset input from when the outputs are turned ON and until 0.4 seconds passes after the outputs are turned OFF.

<G9SX-GS>

1. Use a mode selector that has an SPST-NO + SPST-NC contact form (e.g., OMRON's A22K-□-11-□□).
2. This is a class A product. In residential areas it may cause radio interference, in which case the user may be required to take adequate measures to reduce interference.

Safety Category (EN ISO 13849-1)

In the condition shown in *Application Examples*, G9SX can be used for the corresponding categories up to Safety category 4 per EN ISO13849-1.

This does NOT mean that G9SX can always be used for required category under all the similar conditions and situations. Conformity to the categories must be assessed as a whole system. When using G9SX for safety categories, be sure to confirm the conformity as a whole system.

Applicable Safety Category 4 (EN ISO13849-1)

1. Input signals to both safety inputs (T11-T12, T21-T22, T61-T62, and T71-T72).
2. Input signals to the safety inputs (T11-T12, T21-T22, T61-T62, and T71-T72) through switches equipped with a direct opening mechanism.
When using limit switches, at least one of them must have a direct opening mechanism.
3. When connecting a Safety Sensor to the G9SX, use a TYPE 4 Safety Sensor.
4. Input the signal through a NC contact of the contactor to Feedback/Reset input (T31-T32 for manual reset or T31-T33 for auto reset).
5. Keep the cross fault detection mode input (Y1 and Y2) open.
However, when connecting devices that have a self-diagnosis function, such as Safety Sensors, apply 24 VDC to Y1 or Y2.
6. Be sure to connect A2 to ground.
7. When using a G9SX-EX□-□ Expansion Unit, connect fuses with a current rating of 3.15 A maximum to the safety relay outputs to prevent the contacts from welding.

Standards Certification

Directives

- EMC Directive
- Machinery Directive

Standards/UL Certification

Item	Model	G9SX-AD G9SX-ADA	G9SX-BC	G9SX-GS	G9SX-EX
Approved by TÜV SÜD	EN ISO13849-1 PLe/Safety Category 4	Approved	Approved	Approved	Approved
	IEC/EN 61508 SIL3	Approved	Approved	Approved	Approved
	IEC/EN 62061 SIL3	Not approved	Not approved	Approved	Not approved
	IEC/EN 61000-6-2	Approved	Approved	Approved	Approved
	IEC/EN 61000-6-4	Approved	Approved	Approved	Approved
Approved by UL	UL508	Approved	Approved	Approved	Approved
	UL1998	Approved	Approved	Approved	Approved
	CAN/CSA C22.2 No.142	Approved	Approved	Approved	Approved
Approved by KOSHA		Approved	Approved	Approved	Approved

G9SX-SM

Sensor-less Monitoring of Standstill for Machines with Long Inertia

- Standstill is monitored by the motor's back electromotive force (BEMF) signal.
- Features a "Standard Configuration", allowing immediate use without sensitivity adjustment.
- "User Configuration" also available for fine-tuning of sensitivity.
- Detailed LED indications enable easy fault diagnosis.
- Safety Category 4, PLe (EN ISO13849-1), SIL 3 (IEC/EN 62061) certified.



 Be sure to read the *Safety Precautions* on page 65.

Model Number Structure

Model Number Legend

G9SX- -
 1 2 3 4 5

- | | |
|---|---|
| <p>1. Functions
SM: Standstill Monitoring Unit</p> <p>2. Output Configuration (Safety Outputs)
0: None</p> <p>3. Output Configuration (Safety standstill detection outputs)
3: 3 outputs</p> | <p>4. Output Configuration (Auxiliary Outputs)
2: 2 outputs</p> <p>5. Terminal block type
RT: Screw terminals
RC: Spring-cage terminals</p> |
|---|---|

List of Models

Standstill Monitoring Unit

Safety outputs	Safety standstill detection output	Auxiliary output	Rated voltage	Terminal block type	Model
--	3	2	24 VDC	Screw terminals	G9SX-SM032-RT
				Spring-cage terminals	G9SX-SM032-RC

G9SX-SM

Specifications

Ratings

Power input

Item	Model	G9SX-SM032-□
Rated supply voltage		24 VDC
Operating voltage range		-15% to 10% of rated supply voltage
Power consumption *		4 W max.

* Power consumption of loads not included.

Inputs

Item	Model	G9SX-SM032-□
Rated Input voltage		Standstill detection input (between Z1 and Z2 and between Z3 and Z4) *1 480 VAC max. (120Hz max.) *2
Internal impedance		Standstill detection input: Approx. 660 kΩ EDM input: Approx. 2.8 kΩ *3

*1. Input the motor phase-to-phase voltage between Z1 and Z2 and between Z3 and Z4.

*2. When a motor with AC240V or more is used, connect neutral point of the power supply to earth.

*3. Use a contact that is applicable to microloads (24 VDC, 5 mA) for connection to the EDM input.

Outputs

Item	Model	G9SX-SM032-□
Safety standstill detection output *1		Source output (PNP), load current: 0.3 A DC max. *2
Auxiliary output (output monitor/error)		Source output (PNP), load current: 100 mA DC max.

*1. While safety standstill detection outputs are in the ON state, the following pulse signal is output continuously for output circuit diagnosis.

When using the safety standstill detection outputs as input signals to control devices (i.e. Programmable Controllers), consider the pulse signal shown below.

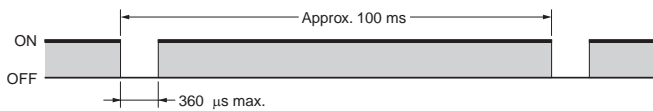

*2. The following derating is required when Units are mounted side-by-side.

G9SX-SM032-□: 0.2 A max. load current

Characteristics

Item	Model	G9SX-SM032-□
Over-voltage category (IEC/EN 60664-1)		III
Response time (Standstill detection ON to OFF)		50 ms max.
Detection voltage (Standstill detection voltage)		Standard Configuration: 10 mV max. User Configuration: 100 mV max.
ON-state residual voltage		3.0 V max. (Safety standstill detection outputs and auxiliary outputs)
OFF-state leakage current		0.1 mA max. (Safety standstill detection outputs and Auxiliary outputs)
Maximum cable length for standstill detection inputs and EDM inputs		100 m max. (External connection impedance: 100 Ω max. and 10 nF max.)
Insulation resistance	Between standstill detection inputs (Z1,Z2↔Z3,Z4)	100 MΩ min., 500 VDC megger
	Between standstill detection input terminals connected together and other input and output terminals connected together	
	Between all terminals without standstill detection input terminals connected together and DIN rail	
	Between standstill detection input terminals connected together and DIN rail.	
Dielectric strength	Between standstill detection inputs (Z1,Z2↔Z3,Z4)	2,000 VAC for 1 min.
	Between standstill detection input terminals connected together and Power supply input terminals and other input and output terminals connected together	2,200 VAC for 1 min.
	Between all terminals without standstill detection input terminals connected together and DIN rail	500 VAC for 1 min.
	Between standstill detection input terminals connected together and DIN rail.	2,200 VAC for 1 min.
Vibration resistance		Frequency: 10 to 55 to 10 Hz, 0.375-mm single amplitude (0.75-mm double amplitude)
Mechanical shock resistance	Destruction	300 m/s ²
	Malfunction	100 m/s ²
Ambient temperature		-10 to +55 °C (no icing or condensation)
Ambient humidity		25% to 85%
Degree of protection		Terminal block : IP20, Main body : IP40
Terminal tightening torque *		0.6N·m
Weight		Approx. 200 g

* For G9SX-SM032-RT (with screw terminals)

G9SX-SM

Connections

Internal Connection

G9SX-SM032-□(Standstill Monitoring Unit)

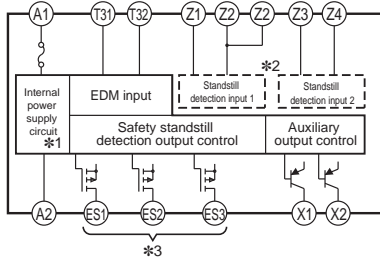

*1. Internal power supply circuit is not isolated.

*2. Standstill detection inputs are isolated respectively.

*3. The Safety standstill detection outputs, ES1 - ES3, are internally redundant respectively.

Wiring of inputs and outputs

Signal Name	Terminal Name	Description of operation	Wiring
Power supply input	A1,A2	Power supply input for G9SX-SM□. Connect the power source to the A1 and A2 terminals.	Connect the power supply plus to the A1 terminal. Connect the power supply minus to the A2 terminal.
Standstill detection input 1	Z1,Z2	To turn on the Safety standstill detection outputs, both standstill detection inputs must be below the threshold voltage. Otherwise, Safety standstill detection outputs will NOT be turned ON.	
Standstill detection input 2	Z3,Z4	When the wiring between the motor and G9SX-SM□ breaks, G9SX-SM□ detects it as failure of the wiring or continues to operated as motor is rotating, regardless of the status of motor. Thus the breakage of wiring does not lead to a dangerous situation.	
EDM input	T31,T32	To turn on safety standstill detection outputs, ON-state signals should be input to T32. Otherwise, Safety standstill detection outputs will not be turned ON.	Corresponds to category 3
			Corresponds to category 4
Safety standstill detection output	ES1,ES2,ES3	Turns ON/OFF according to the state of standstill detection inputs and EDM input.	Keep these outputs Open when NOT used.
Auxiliary output (Monitor)	X1	Outputs a signal while the motor is determined as in a standstill condition.	Keep these outputs Open when NOT used.
Auxiliary output (Error)	X2	Turns ON when the error indicator is blinking or lit.	Keep these outputs Open when NOT used.

* For protecting the motor against short-circuit due to incorrect wiring, etc., apply overcurrent protective equipment: fuses, circuit-breaker, etc., with the ratings below.

Rated voltage: Greater than standstill detection inputs
(voltage supplied to the motor)

Rated current: 3A max.

Functions

Configuration and Mode

Use the "Operation Preset switch" on the back side to select either Standard Configuration or User Configuration. The selected configuration mode is enabled at power-on. Normally, please use Standard Configuration which is set as factory default. If the standstill determining time is found too long in the Standard Configuration mode, switch to User Configuration and adjust the standstill determining time.

Standard Configuration

When G9SX-SM detects that the standstill detection input voltage is 10 mV or less, it will turn on safety standstill detection outputs, determining the motor is in a standstill condition.

In Standard Configuration, any settings with the Mode preset switch on the back of the unit and both of the Standstill determining time preset switches on the front and on the back of the unit are disabled.

User Configuration

When G9SX-SM detects that the standstill detection input voltage has been 100 mV or less for a predetermined standstill determining time or longer, or when G9SX-SM detects that the standstill detection input voltage has been 10mV or less, it will turn ON safety standstill detection outputs, determining the motor is in a standstill condition.

In User Configuration, two modes are available: Tuning mode (TUN) and Monitoring Mode (MON). Either can be selected by setting the "Mode Preset switch".

The selected mode is applied at power-on.

Mode name	Function	Operation
Tuning Mode	Use this mode to adjust the standstill determining time. This mode is only for adjusting the standstill determining time. *	To preset the standstill determining time, use the "DET TIME switch (the standstill determining time preset switch)" on the front side. Once the DET TIME setting is changed, the new setting immediately comes into effect on the system without having to perform a power cycle. When a standstill condition is detected, the auxiliary monitor output is turned ON and the ES Indicator is lit, but safety standstill detection outputs are NOT turned ON.
Monitoring Mode	Use this mode in normal operation after the Standstill determining time is fixed.	In this mode, G9SX-SM operation depends on the "DET TIME switches (the standstill determining time preset switches)", one each on the front side and the back side. The DET TIME (standstill determining time) setting values come into effect at power on.

* If the optimal standstill determining time is already known, the value can be applied to the Monitoring Mode, without having to use the Tuning Mode.

Operation Preset switch/Mode Preset switch

Use switches on the back side of the unit for operation preset and mode preset.

Manipulation of preset switches must be done while the power is off.

Name	Function	Configuration
Configuration Preset Switch	Selects either Standard configuration or User configuration	STD (Standard Configuration: default setting)/USR (User Configuration)
ModePreset Switch	Selects either Tuning mode or Monitoring mode in User configuration.	MON(Monitoring Mode : default setting)/TUN(Tuning Mode)

Note: The preset switch setting comes into effect at power on.

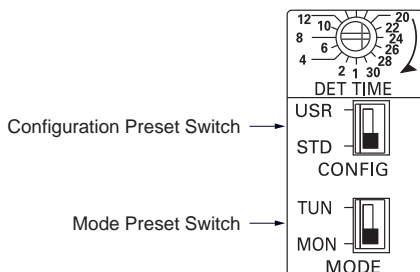

Standstill Determining Time Preset Switch

Presets the standstill determining time in User Configuration.

Configuration is made through switches on the front and back side of the unit. Operation can be normal only if both switch values are the same. If the values are different, an error occurs.

Name	Function	Configuration
Standstill determining time preset switch	Presets the standstill determining time in User Configuration	1/2/4/6/8/10/12/14/16/18/20/22/24/26/28/30(Factory shipment)(s)

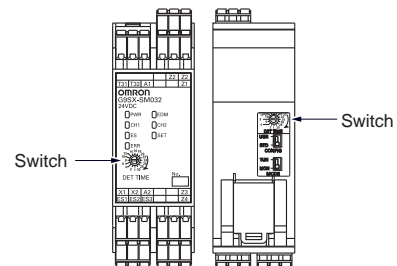

See the illustration below for setting the standstill determining time preset switches. Make sure that the direction of cutting edge of preset switch is correctly pointed to the determining time value which must be set.

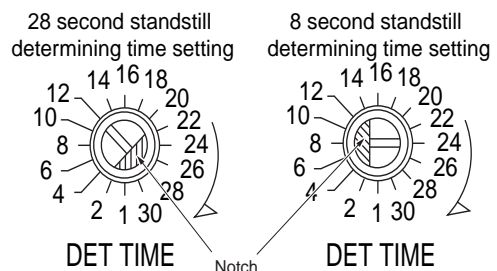

Functions

Standard Configuration

"Standard Configuration" allows standstill detection without tuning sensitivity.

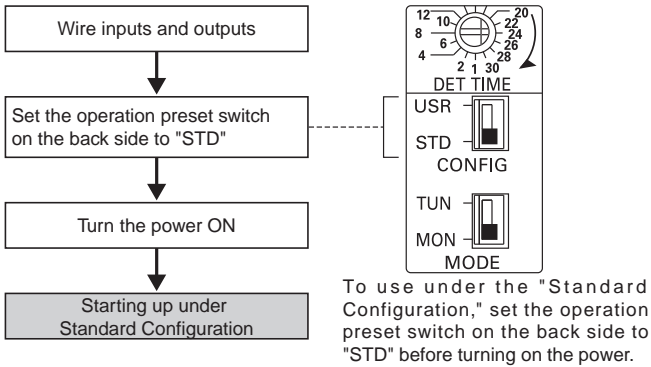

User Configuration

"User Configuration" allows manual tuning to adjust sensitivity. User Configuration has Tuning Mode to tune sensitivity and Monitoring Mode to detect the standstill condition.

(1) Start up under the Tuning Mode

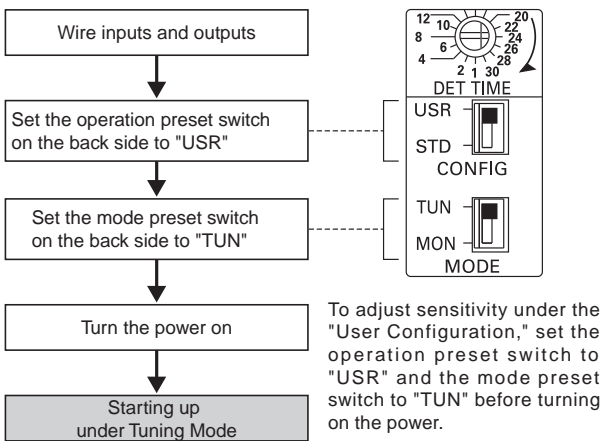

(2) Adjust sensitivity

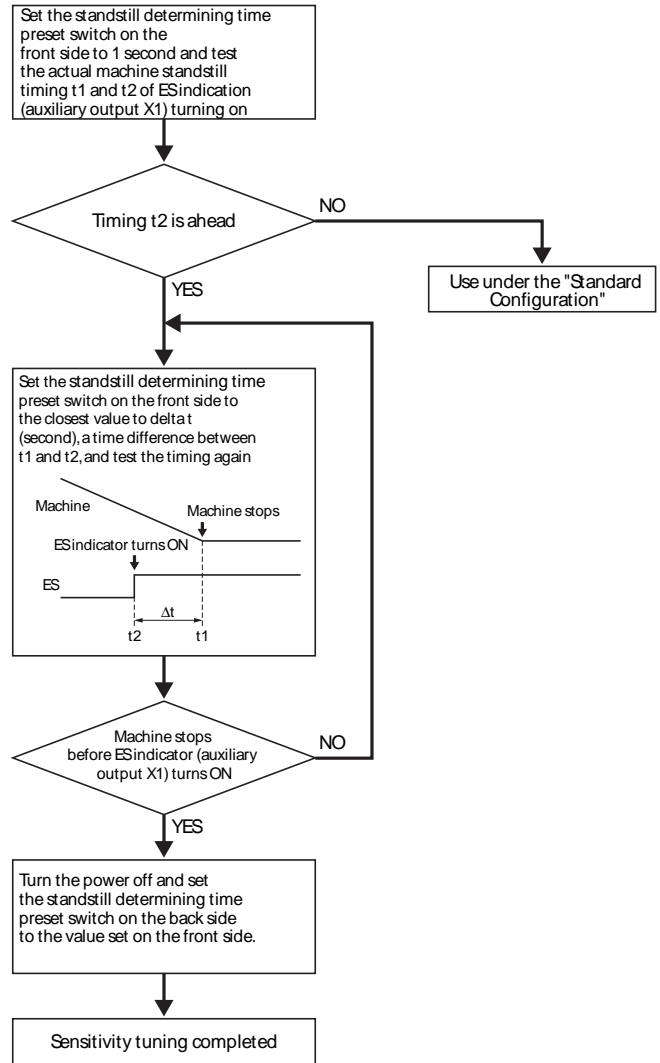

(3) Monitor under the User Configuration

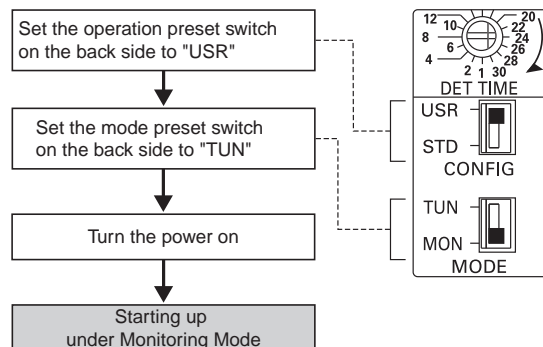

LED Indicators

Marking	Color	Name	Function
PWR	Green	Power supply indicator	Lights up while power is supplied.
EDM	Orange	EDM input indicator	Lights up while a HIGH state signal is input to T32. Blinks when error relating to EDM (External Device Monitoring) input occurs.
CH1	Orange	Standstill detection input ch1 indicator	Lights up while the standstill detection input voltage between Z1 and Z2 is below the threshold voltage. Blinks when an error relating to standstill detection input ch1 occurs. *
CH2	Orange	Standstill detection input ch2 indicator	Lights up while the standstill detection input voltage between Z3 and Z4 is below the threshold voltage. Blinks when an error relating to standstill detection input ch2 occurs. *
ES	Orange	Safety standstill detection output indicator	Lights up while the Safety standstill detection outputs (ES1, ES2, ES3) are in the ON-state. Blinks when an error relating to the Safety standstill detection input occurs. *
SET	Orange	Setting indicator	Depending on the status of operation preset switch and mode preset switch. See below for details. Standard Configuration: Turns OFF Tuning Mode in User Configuration: Blinks Monitoring Mode in User Configuration: Lights up Blinks when an error relating the selected configuration mode occurs. *
ERR	Red	Error indicator	Lights up or blinks depending on the occurring error *

* Refer to "Fault Detection" on the next page for details

Settings indication (at power ON)

Settings for G9SX-SM can be checked by indicators for approx. 3 seconds after power on. During the settings indication term, ERR indicator will light up, however the auxiliary error output will remain off.

Indicator	Item	Indicator status	Setting mode	Setting status
SET	Standard/User Configuration	Not lit	Standard Configuration	STD
		Light up	User Configuration	USR

Fault Detection

When the G9SX-SM□ detects a fault, the ERR indicator and/or other indicators light up or blink to inform the user about the fault. Take actions based on the table shown below. After the action, turn the power on again.

EER indicator	Other indicator	Fault	Expected causes of the fault	Checking points and measures to take
Blink	--	Fault by electro-magnetic disturbance or of internal circuits.	1) Excessive electro-magnetic disturbance 2) Failure of the internal circuit	1) Check the disturbance level around G9SX-SM and its related system. 2) Replace with a new product.
Light up	CH1 blinks	Faults involved with Standstill detection input 1	1) Failure involving the wiring of standstill detection input 1 2) Inverter dynamic brake setting 3) Failure of the circuit of standstill detection input 1	1) Check the wiring to Z1 and Z2. 2) Set the brake time at less than 30 seconds. 3) Replace with a new product.
	CH2 blinks	Faults involved with Standstill detection input 2	1) Failure involving the wiring of standstill detection input 2 2) Inverter dynamic brake setting 3) Failure of the circuit of standstill detection input 2	1) Check the wiring to Z3 and Z4. 2) Set the brake time at less than 30 seconds. 3) Replace with a new product.
	CH1 and CH2 Blink at once	Faults involved with Standstill detection input	1) Frequency of standstill detection input is out range.	1) Confirm the operation frequency of the motor is 120Hz or less.
	EDM blinks	Faults involved with EDM input	1) Failure involving the wiring of EDM input 2) Excessive electro-magnetic disturbance 3) Failure of the circuit of the EDM input	1) Check the wiring to T31 and T32 2) Separately wire to T31 and T32 from the power line etc. of the inverter. 3) Replace with a new product.
	ES blinks	Faults involved with Safety Standstill detection outputs	1) Failure involving the wiring of Safety standstill detection outputs 2) Excessive electro-magnetic disturbance 3) Failure of the circuit of Safety standstill detection outputs 4) Impermissible high ambient temperature	1) Check the wiring to ES1, ES2 and ES3 2) Separately wire to ES1, ES2 and ES3 from the power line etc. of the inverter. 3) Replace with a new product. 4) Check the ambient temperature and spacing around G9SX-SM.
	SET blinks	Faults involved with Operation mode settings	1) Incorrect set values of Standstill determining time preset switches. 2) Failure of the circuit of mode settings	1) Check the set values of the two of Standstill determining time preset switches. 2) Replace with a new product.
	The All (without PWR) indicators blink	Supply voltage outside the rated value	1) Supply voltage outside the rated value	1) Check the supply voltage to G9SX units.

When some indicators blink except ERR indicator, check and take needed actions referring to the following table.

EER indicator	Other indicator	Fault	Expected causes of the fault	Checking points and measures to take
Light off	SET blinks	Tuning Mode operation	Operating Mode is in Tuning Mode of User Configuration.	Check if the Operation preset switch and the Mode preset switch on the back side are properly set. In the User Configuration Mode, safety standstill detection outputs will NOT be turned ON.

Dimensions and Terminal Arrangement

(unit: mm)

Standstill Monitoring Unit G9SX-SM032-□

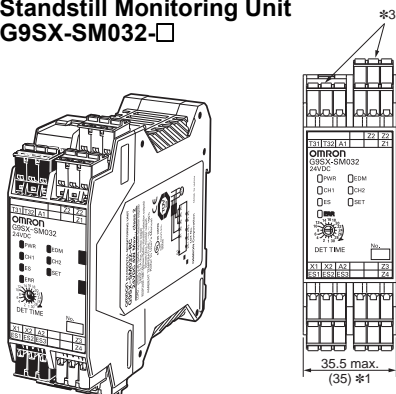

- *1. Typical dimension
- *2. For -RC terminal type only.
- *3. The terminal colors are green for the Unit right side (Standstill detection input) and black for the left side.

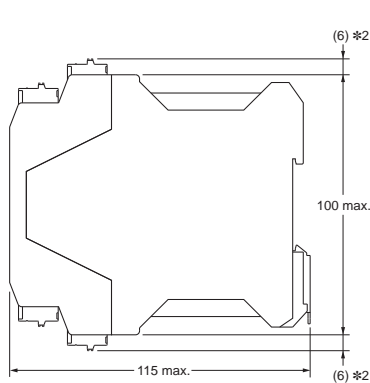

Terminal arrangement

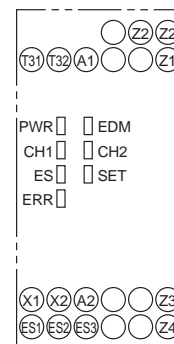

Note: Above outline drawing is for -RC terminal type.

Application Examples

G9SX-SM032 (24 VDC) (3-phase Induction Motor)

+ G9SX-AD322-T15 (24 VDC)

(Guard Lock Safety Door Switch, 2-channel Safety Limit Switch Inputs/Manual Reset)

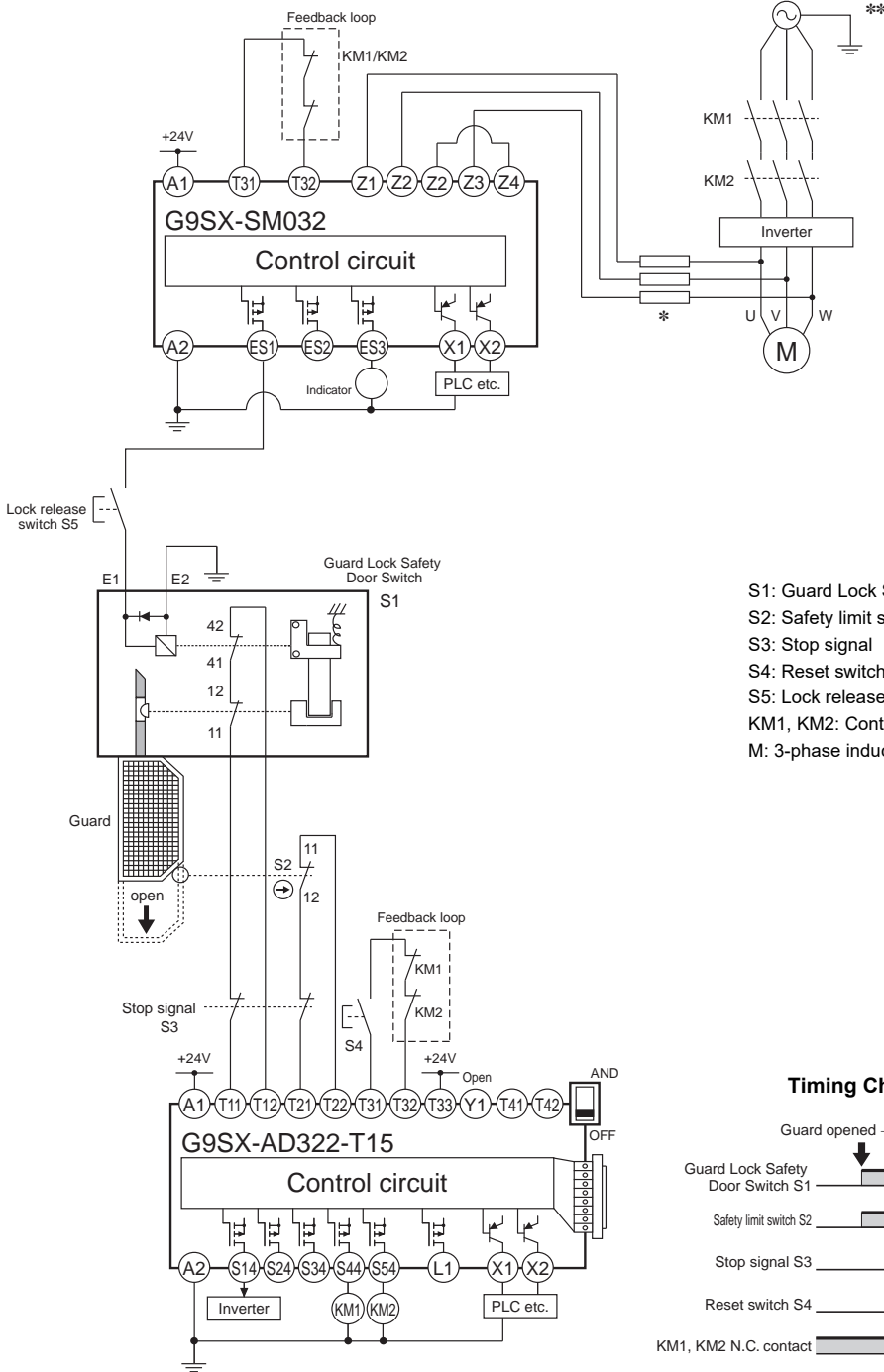

- S1: Guard Lock Safety Door Switch
- S2: Safety limit switch
- S3: Stop signal
- S4: Reset switch
- S5: Lock release switch
- KM1, KM2: Contactor
- M: 3-phase induction motor

Timing Chart

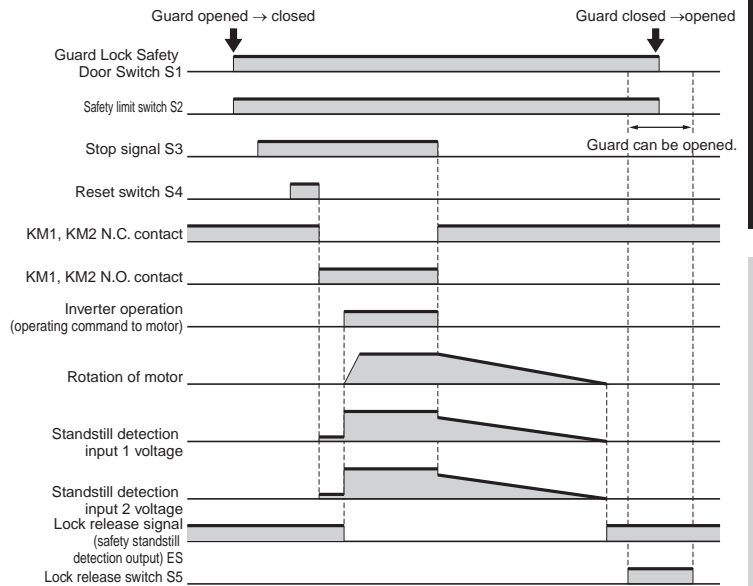

Note: This circuit example is equivalent to Safety Category 4 (Stop Category 1).

For details, see "Safety Category (EN ISO 13849-1)".

* For protecting the motor against short-circuit due to incorrect wiring, etc., apply overcurrent protective equipment: fuses, circuit-breaker, etc., with the ratings below.

Rated voltage: Greater than standstill detection inputs (voltage supplied to the motor)

Rated current: 3A max.

** When a motor with AC240V or more is used, connect neutral point of the power supply to earth.

G9SX-AD□/BC/EX

G9SX-GS

G9SX-AD□/BC/EX,
G9SX-GS Common

G9SX-SM

G9SX-NS

G9SX-SM

G9SX-SM032 (24 VDC) (3-phase Induction Motor)

+ G9SX-BC202 (24 VDC) (2-channel Emergency Stop Switch Inputs/Manual Reset)

+ G9SX-GS226-T15 (24 VDC)

(Guard Lock Safety Door Switch + 2-channel Safety Limit Switch Inputs/Manual Reset)

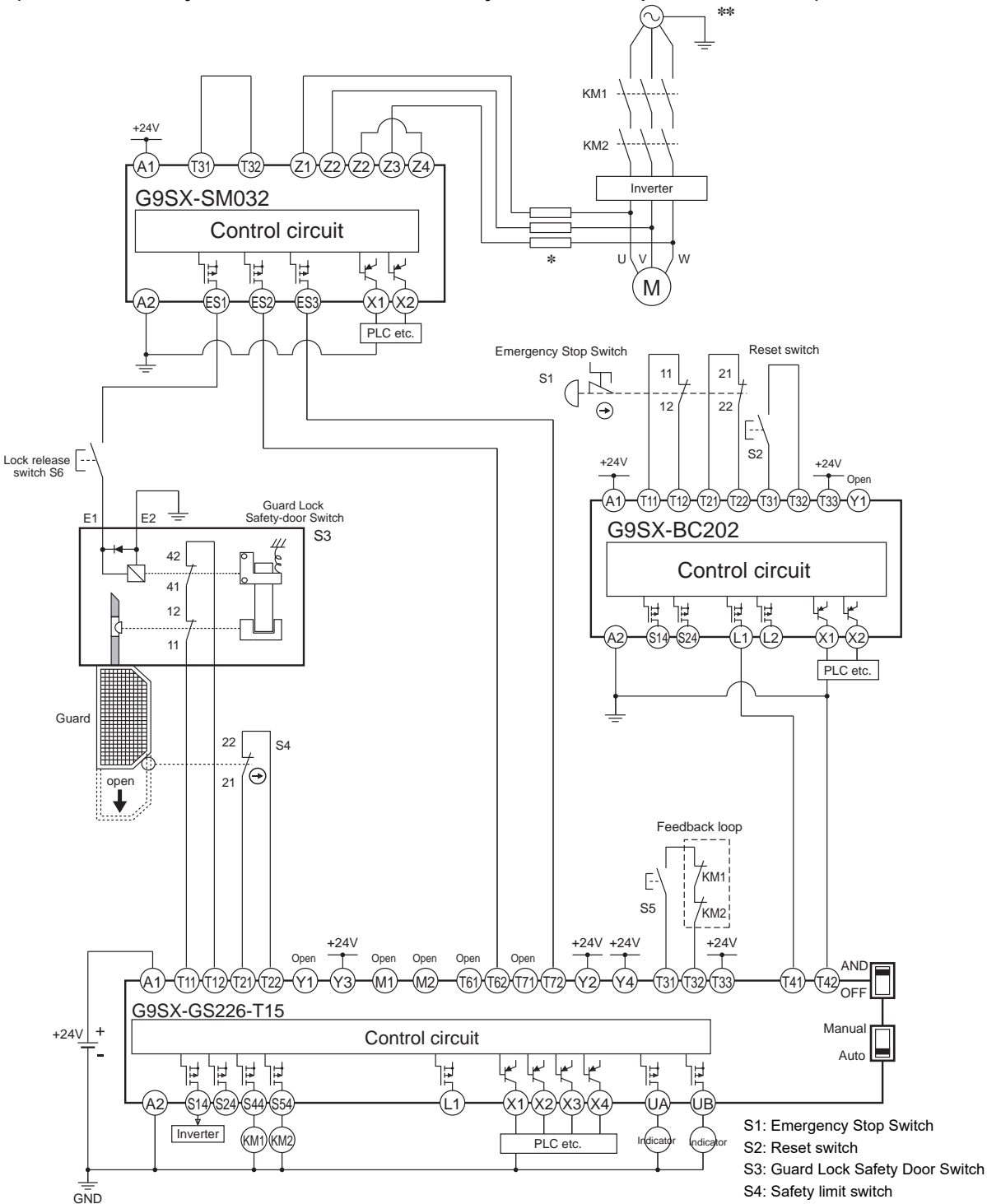

Note: 1. This circuit example is equivalent to Safety Category 3 (Stop Category 2). For details, see "Safety Category (EN ISO 13849-1)".

2. Power for the inverter is cut when the motor rotation is detected in this system with a guard open.

Its response time is an accumulation of G9SX-SM and G9SX-GS. Determine a safety distance to hazards in view of this response time.

* For protecting the motor against short-circuit due to incorrect wiring, etc., apply overcurrent protective equipment: fuses, circuit-breaker, etc., with the ratings below.

Rated voltage: Greater than standstill detection inputs
(voltage supplied to the motor)

Rated current: 3A max.

** When a motor with AC240V or more is used, connect neutral point of the power supply to earth.

Timing Chart

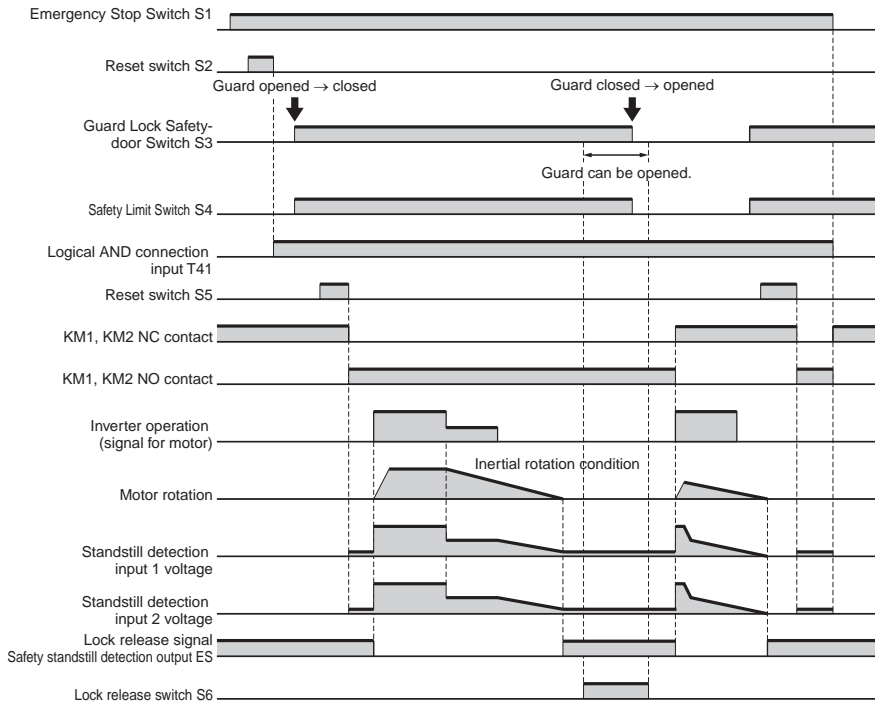

G9SX-AD□/BC/EX

G9SX-GS

G9SX-AD□/BC/EX,
G9SX-GS Common

G9SX-SM

G9SX-NS

G9SX-SM

**G9SX-SM032 (24 VDC) (3-phase Induction Motor with Star-Delta wiring)
+ G9SX-BC202 (24 VDC)
(Guard Lock Safety Door Switch + 2-channel Safety Limit Switch inputs/Manual Reset)**

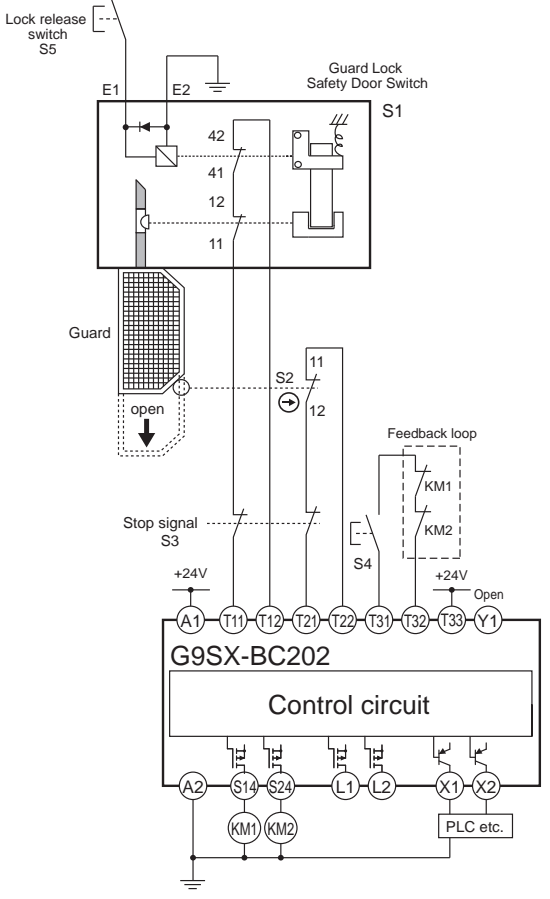
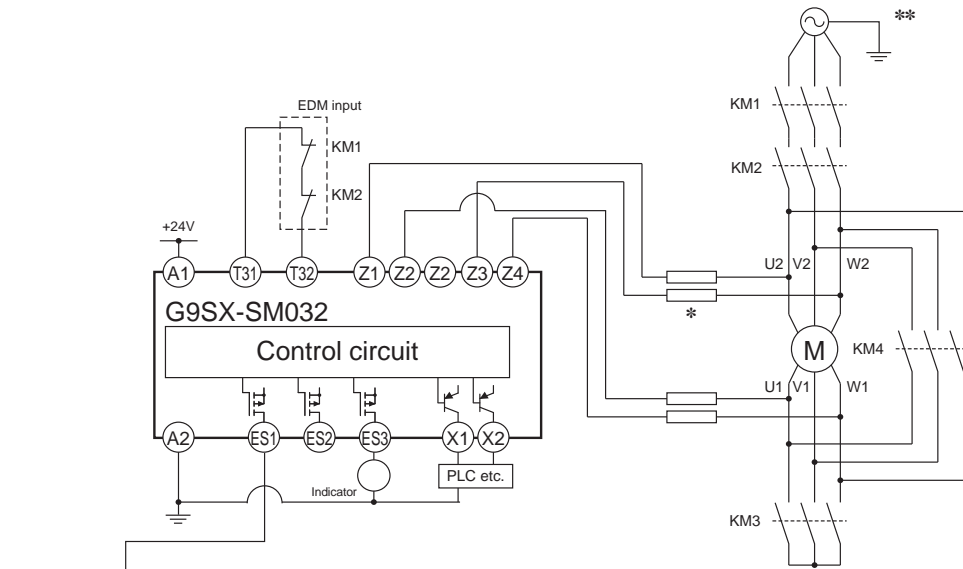

- S1: Guard lock Safety-door Switch
- S2: Safety Limit Switch
- S3: Stop signal
- S4: Reset switch
- S5: Lock release switch
- KM1, KM2: Contactor
- KM3, KM4: Contactor for star-delta starter
- M: 3-phase induction motor



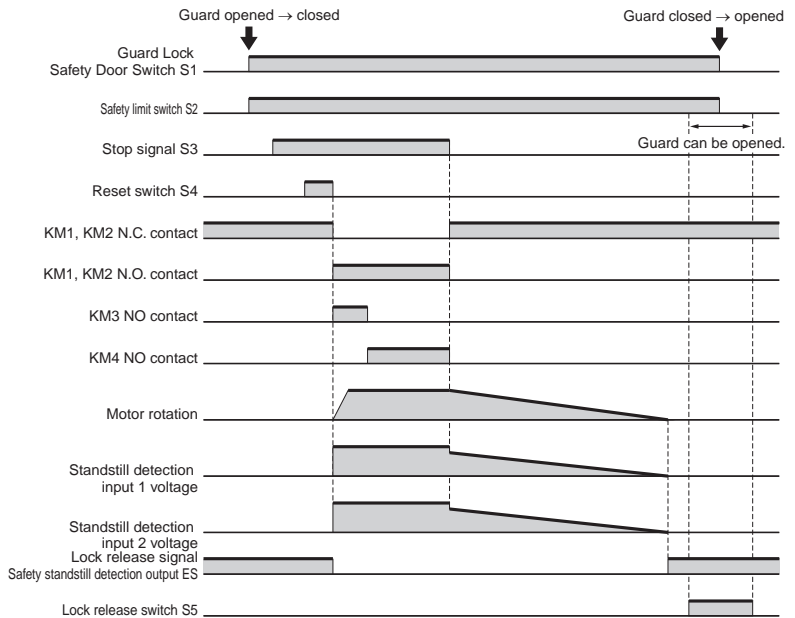

Timing Chart



Note: This circuit example is equivalent to Safety Category 4 (Stop Category 0).
For details, see "Safety Category (EN ISO 13849-1)".
* For protecting the motor against short-circuit due to incorrect wiring, etc., apply overcurrent protective equipment: fuses, circuit-breaker, etc., with the ratings below.
Rated voltage: Greater than standstill detection inputs (voltage supplied to the motor)
Rated current: 3A max.
** When a motor with AC240V or more is used, connect neutral point of the power supply to earth.

Operational procedure

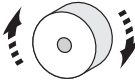
Standard Configuration

Operation		LED indicator	Machine operation	ES output	X1 output
Wire inputs and outputs	Set the operation preset switch on the back side to "STD"		--	--	--
Turn the power ON	Initial configuration display	<input type="checkbox"/> PWR <input type="checkbox"/> EDM <input type="checkbox"/> CH1 <input type="checkbox"/> CH2 <input type="checkbox"/> ES <input type="checkbox"/> SET <input type="checkbox"/> ERR	Standstill 	OFF	OFF
	Monitoring starts	<input type="checkbox"/> PWR <input type="checkbox"/> EDM <input type="checkbox"/> CH1 <input type="checkbox"/> CH2 <input type="checkbox"/> ES <input type="checkbox"/> SET <input type="checkbox"/> ERR		ON	ON
Machine operation	Rotation is detected and ES turns OFF	<input type="checkbox"/> PWR <input type="checkbox"/> EDM <input type="checkbox"/> CH1 <input type="checkbox"/> CH2 <input type="checkbox"/> ES <input type="checkbox"/> SET <input type="checkbox"/> ERR	Rotating 	OFF	OFF
Stop command	Decelerating	<input type="checkbox"/> PWR <input type="checkbox"/> EDM <input type="checkbox"/> CH1 <input type="checkbox"/> CH2 <input type="checkbox"/> ES <input type="checkbox"/> SET <input type="checkbox"/> ERR	Decelerating 		
	Standstill is detected and ES turns ON	<input type="checkbox"/> PWR <input type="checkbox"/> EDM <input type="checkbox"/> CH1 <input type="checkbox"/> CH2 <input type="checkbox"/> ES <input type="checkbox"/> SET <input type="checkbox"/> ERR	Standstill 	ON	ON

Note: LED indication is based on wiring equivalent to safety category 4. For wiring equivalent to category 3, EDM lights up even during the machine operation.

G9SX-AD□/BC/EX

G9SX-GS









G9SX-AD□/BC/EX,
G9SX-GS Common

G9SX-SM

G9SX-NS



User Configuration

Tuning Mode

Operation			LED indicator	Machine operation	ES output	X1 output
Wire inputs and outputs	Set the operation preset switch on the back side to "USR"	 USR STD CONFIG	--	 Standstill	--	--
	Set the mode preset switch on the back side to "TUN"	 TUN MON MODE				
	Set the standstill determining time preset switch on the front side to 1 second	 DET TIME				
Turn the power ON	Initial configuration display	<input type="checkbox"/> PWR <input type="checkbox"/> EDM <input type="checkbox"/> CH1 <input type="checkbox"/> CH2 <input type="checkbox"/> ES <input type="checkbox"/> SET <input type="checkbox"/> ERR		OFF	OFF	
	Tuning starts	<input type="checkbox"/> PWR <input type="checkbox"/> EDM <input type="checkbox"/> CH1 <input type="checkbox"/> CH2 <input type="checkbox"/> ES <input checked="" type="checkbox"/> SET <input type="checkbox"/> ERR				ON
Machine trial run	Rotation is detected and CH1/CH2/ES turn OFF (Auxiliary output X1 turns OFF)	<input type="checkbox"/> PWR <input type="checkbox"/> EDM <input type="checkbox"/> CH1 <input type="checkbox"/> CH2 <input type="checkbox"/> ES <input checked="" type="checkbox"/> SET <input type="checkbox"/> ERR	 Rotating	OFF	OFF	
Stop command		<input type="checkbox"/> PWR <input type="checkbox"/> EDM <input type="checkbox"/> CH1 <input type="checkbox"/> CH2 <input type="checkbox"/> ES <input checked="" type="checkbox"/> SET <input type="checkbox"/> ERR	 Decelerating			
	CH1/CH2/ES light up (Auxiliary output X1 turns ON)	<input type="checkbox"/> PWR <input type="checkbox"/> EDM <input type="checkbox"/> CH1 <input type="checkbox"/> CH2 <input type="checkbox"/> ES <input checked="" type="checkbox"/> SET <input type="checkbox"/> ERR	 Decelerating			
		<input type="checkbox"/> PWR <input type="checkbox"/> EDM <input type="checkbox"/> CH1 <input type="checkbox"/> CH2 <input type="checkbox"/> ES <input checked="" type="checkbox"/> SET <input type="checkbox"/> ERR	Stops in 1 second after ES lighting up 	ON		

Note: LED indication is based on wiring equivalent to safety category 4. For wiring equivalent to category 3, EDM lights up even during the machine operation.

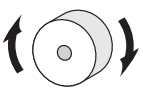
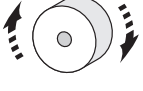
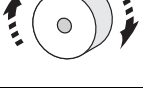
Tuning Mode (continued)

Operation	LED indicator		Machine operation	ES output	X1 output
Set the standstill determining time preset switch on the front side to T seconds	--		--	--	--
Machine trial run	<input type="checkbox"/> PWR <input type="checkbox"/> EDM <input type="checkbox"/> CH1 <input type="checkbox"/> CH2 <input type="checkbox"/> ES <input checked="" type="checkbox"/> SET <input type="checkbox"/> ERR		Rotating 	OFF	OFF
	<input type="checkbox"/> PWR <input type="checkbox"/> EDM <input type="checkbox"/> CH1 <input type="checkbox"/> CH2 <input type="checkbox"/> ES <input checked="" type="checkbox"/> SET <input type="checkbox"/> ERR		Decelerating 		
	<input type="checkbox"/> PWR <input type="checkbox"/> EDM <input type="checkbox"/> CH1 <input type="checkbox"/> CH2 <input type="checkbox"/> ES <input checked="" type="checkbox"/> SET <input type="checkbox"/> ERR		Decelerating 		
Stop command	<input type="checkbox"/> PWR <input type="checkbox"/> EDM <input type="checkbox"/> CH1 <input type="checkbox"/> CH2 <input type="checkbox"/> ES <input checked="" type="checkbox"/> SET <input type="checkbox"/> ERR		Standstill 	ON	ON

Tuning completed If ES lights up before the machine comes to standstill, set a larger DET time and repeat the procedure from machine trial run to stop command.

Note: LED indication is based on wiring equivalent to safety category 4. For wiring equivalent to category 3, EDM lights up even during the machine operation.

G9SX-AD□/BC/EX









G9SX-GS

G9SX-AD□/BC/EX,
G9SX-GS Common

G9SX-SM

G9SX-NS

Monitoring Mode

Operation			LED indicator	Machine operation	ES output	X1 output	
Set the operation preset switch on the back side to "USR"	 USR STD CONFIG	Set the standstill determining time preset switch on the back side to a setup value determined by the Tuning Mode	--	Standstill 	--	--	
Set the mode preset switch on the back side to "MON"	 TUN MON MODE						
Turn the power ON			Initial configuration display	<input type="checkbox"/> PWR <input type="checkbox"/> EDM <input type="checkbox"/> CH1 <input type="checkbox"/> CH2 <input type="checkbox"/> ES <input type="checkbox"/> SET <input type="checkbox"/> ERR		OFF	OFF
			Monitoring starts	<input type="checkbox"/> PWR <input type="checkbox"/> EDM <input type="checkbox"/> CH1 <input type="checkbox"/> CH2 <input type="checkbox"/> ES <input type="checkbox"/> SET <input type="checkbox"/> ERR		ON	ON
Machine operation			Rotation is detected and ES turns OFF	<input type="checkbox"/> PWR <input type="checkbox"/> EDM <input type="checkbox"/> CH1 <input type="checkbox"/> CH2 <input type="checkbox"/> ES <input type="checkbox"/> SET <input type="checkbox"/> ERR	Rotating 		
Stop command				<input type="checkbox"/> PWR <input type="checkbox"/> EDM <input type="checkbox"/> CH1 <input type="checkbox"/> CH2 <input type="checkbox"/> ES <input type="checkbox"/> SET <input type="checkbox"/> ERR	Decelerating 	OFF	OFF
			CH1/CH2 light up	<input type="checkbox"/> PWR <input type="checkbox"/> EDM <input type="checkbox"/> CH1 <input type="checkbox"/> CH2 <input type="checkbox"/> ES <input type="checkbox"/> SET <input type="checkbox"/> ERR	Decelerating 		
			ES lights up after a specified DET time passed	<input type="checkbox"/> PWR <input type="checkbox"/> EDM <input type="checkbox"/> CH1 <input type="checkbox"/> CH2 <input type="checkbox"/> ES <input type="checkbox"/> SET <input type="checkbox"/> ERR	Standstill 	ON	ON

Note: LED indication is based on wiring equivalent to safety category 4. For wiring equivalent to category 3, EDM lights up even during the machine operation.

Safety Precautions

WARNING

Serious injury may possibly occur due to breakdown of safety outputs.

Do not connect loads beyond the rated value to the safety outputs. 

Serious injury may possibly occur due to loss of required safety functions.

Do not use G9SX-SM□ in the system where plurality of motors are driven by one inverter or contactor. 

Serious injury may possibly occur due to loss of required safety functions.

Wire G9SX-SM□ properly so that supply voltages or voltages for loads do NOT touch the safety inputs accidentally or unintentionally. 

Serious injury may possibly occur due to damages of safety inputs.

Apply protection circuitry against back electromotive force in case connecting inductive loads to safety outputs. 

Serious injury may possibly occur due to loss of required safety functions.

Monitor a motor that operates on a commercial frequency (60 Hz) or lower. 

Serious injury may possibly occur due to loss of safety functions.

Operate the motor at rated G9SX-SM□ input frequency (120Hz) or less. 

Serious injury may possibly occur due to loss of safety functions.

Use devices appropriate for the application and the condition where G9SX-SM□ is used. 

Control Devices	Requirements
Guard lock Safety-door Switch	Use approved devices with Direct Opening Mechanism complying with IEC/EN 60947-5-1 Use approved devices with Direct Opening Mechanism complying with IEC/EN 60947-5-1, mechanical lock type and capable of solenoid coil 24VDC, less than 300mA.
Safety Relay	Use approved devices with forcibly guided contacts complying with IEC 61810-3 (EN 50205). For feedback purpose use devices with contacts capable of switching micro loads of 24VDC, 5mA.
Contactors	Use approved devices complying with IEC/EN 60947-4-1 for auxiliary contact linked with power contact (mirror contact). For feedback purpose use devices with contacts capable of switching micro loads of 24VDC, 5mA.
Other devices	Evaluate whether devices used are appropriate to satisfy the requirements of safety category level.

Precautions for Safe Use

- Use G9SX-SM□ within an enclosure with IP54 protection or higher of IEC/EN60529. Be sure to connect the enclosure to earth (PE).
- Incorrect wiring may lead to loss of safety function. Wire conductors correctly and verify the operation of G9SX-SM□ before commissioning the system in which G9SX-SM□ is incorporated.
- Do not apply DC voltages exceeding the rated voltages, or any AC voltages to the G9SX-SM□ power supply input. Do not connect to DC distribution network.
- Use DC supply satisfying requirements below to prevent electric shock.
 - DC power supply with double or reinforced insulation, for example, according to IED/EN60950 or EN50178 or a transformer according to IEC/EN61558.
 - DC supply satisfies the requirement for class 2 circuits or limited voltage/current circuit stated in UL 508.
- Apply properly specified voltages to G9SX-SM□ inputs. Applying inappropriate voltages cause G9SX-SM□ to fail to perform its specified function, which leads to the loss of safety functions or damages to G9SX-SM□.
- Auxiliary error outputs and auxiliary monitoring outputs are NOT safety outputs. Do not use auxiliary outputs as any safety output. Such incorrect use causes loss of safety function of G9SX-SM□ and its relevant system.
- After installation of G9SX-SM□, qualified personnel should confirm the installation, and should conduct test operations and maintenance. The qualified personnel should be qualified and authorized to secure the safety on each phases of design, installation, running, maintenance and disposal of system.
- A person in charge, who is familiar to the machine in which G9SX-SM□ is to be installed, should conduct and verify the installation.
- G9SX-SM□ determines that motor stops when the standstill detection input voltage is predetermined value or less. According to the characteristic or load condition of motor, it may turn on safety detection outputs before motor stops completely. In that case, before operation, the qualified personnel should verify that risk of the rotation condition after output is acceptable.
- Perform daily and 6-month inspections for the G9SX-SM□. Otherwise, the system may fail to work properly, resulting in serious injury.
- Do not dismantle, repair, or modify G9SX-SM□. It may lead to loss of its safety functions.
- Use only appropriate components or devices complying with relevant safety standards corresponding to the required level of safety categories. Conformity to requirements of safety category is determined as an entire system. It is recommended to consult a certification body regarding assessment of conformity to the required safety level.
- OMRON shall not be responsible for conformity with any safety standards regarding to customer's entire system.
- Disconnect G9SX-SM□ from power supply when wiring, to prevent electric shock or unexpected operation.
- Be cautious not to have your fingers caught when attaching terminal sockets to the plugs on G9SX-SM□.
- Do not use in combustible gases or explosive gases.
- Driving voltage of the motor is impressed to the standstill detection inputs. Connect overcurrent protective equipment: fuse, circuit-breaker etc. (3A Max.) and tighten the wirings by rated tightening torque to the standstill detection inputs.

Precautions for Correct Use

1. Handle with care
Do not drop G9SX-SM□ to the ground or expose to excessive vibration or mechanical shocks. G9SX-SM□ may be damaged and may not function properly.
2. Conditions of storage
Do not store in such conditions stated below.
 - a. In direct sunlight
 - b. At ambient temperatures out of the range of -10 to 55°C.
 - c. At relative humidity out of the range of 25% to 85% or under such temperature change that causes condensation.
 - d. In corrosive or combustible gases
 - e. With vibration or mechanical shocks out of the rated values.
 - f. Under splashing of water, oil, chemicals
 - g. In the atmosphere containing dust, saline or metal powder. G9SX-SM□ may be damaged and may not function properly.
3. Mounting
Mount G9SX-SM□ to DIN rails with attachments (TYPE PFP-M, not incorporated to this product), not to drop out of rails by vibration etc. especially when the length of DIN railing is short compared to the widths of G9SX-SM□.
Do not use G9SX-SM□ at altitudes over 1,000 meters.
4. Following spacing around G9SX should be available to apply rated current to outputs of G9SX-SM□ and for enough ventilation and wiring:
 - a. At least 25 mm beside side faces of G9SX-SM□.
 - b. At least 50 mm above top face of G9SX-SM□ and below bottom face of G9SX-SM□.

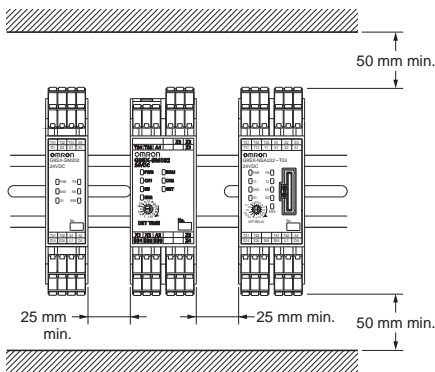

5. Wiring
 - a. G9SX-SM032-□
 - Use the following to wire to G9SX-SM□.

Solid wire	0.2 to 2.5mm ² AWG24 to AWG12
Stranded wire (Flexible wire)	0.2 to 2.5mm ² AWG24 to AWG12

- Strip the cover of wire no longer than 7mm.
- b. G9SX-SM□-RT (with screw terminals)
Tighten each screw with a specified torque of 0.5 to 0.6N·m, or the G9SX-SM□ may malfunction or generate heat.
6. Use cables with length less than 100m to connect to standstill detection Inputs and EDM input respectively.
 7. Driving voltage of the motor is impressed to the standstill detection input and there is a possibility that a high level of noise is superimposed. The line of the standstill input must be separately installed from other signal lines.
 8. Set the time duration of Standstill determining time to an appropriate value that does not cause the loss of safety function of system.
 9. Tuning Mode in User Configuration is only for adjusting the Standstill determining time. In Tuning Mode, auxiliary monitor output is enabled however Safety standstill detection outputs are not enabled. After the tuning is complete, be sure to change from Tuning Mode to Monitoring Mode for actual operation.
 10. Safety standstill detection outputs are only for controlling a guard lock safety-door switch with mechanical lock. They can not be used as safety outputs to drive contactors, or to control a guard lock safety-door switch with solenoid lock.
 11. To determine safety distance to hazards, take into account the delay of safety standstill detection outputs caused by the response time.
 12. Start entire system after more than 5s have passed since applying supply voltage to all G9SXs in the system.
 13. G9SX-SM□ may malfunction due to electro-magnetic disturbances. Be sure to connect the terminal A2 to ground.
 14. This is a class A product. In residential areas it may cause radio interference, in which case the user may be required to take adequate measures to reduce interference.
 15. Devices connected to G9SX-SM□ may operate unexpectedly. When replacing G9SX-SM□, disconnect it from power supply.
 16. Adhesion of solvent such as alcohol, thinner, trichloroethane or gasoline on the product should be avoided. Such solvents make the marking on G9SX-SM□ illegible and cause deterioration of parts.

17. Connectable motor

AC induction motors can be connected to the G9SX-SM□.

- Servo motors cannot be connected.
- When a motor with AC240V or more is used, connect neutral point of the power supply to earth.

18. G9SX-SM□ does not have motor fault detective function or motor protective function. For motor protection, use designated external protective devices.**19. For use with inverter**

The dynamic break setting time should be set to 30 seconds or shorter. Otherwise, the G9SX-SM□ may detect a disconnect fault of the wiring. Also in the following cases, the standstill detection function may not properly work even while the motor is in standstill.

- An inverter with a large output residual voltage is used, and the contactor connected in serial with the inverter is in the ON state.
- The inverter is executing the auto tuning function.

20. Operate the reset input more than 0.4 seconds immediately after the safety outputs are OFF. G9SX-SM□ does not accept the reset input from when the outputs are turned ON and until 0.4 seconds passes after the outputs are turned OFF.**Safety Category (EN ISO13849-1)**

In the condition shown in Application Examples, G9SX can be used for the corresponding categories up to category 4 per EN954-1 and performance level (PL) up to PLe per EN ISO13849-1. This does NOT mean that G9SX-SM can always be used for required category under all the similar conditions and situations.

Conformity to the categories must be assessed as a whole system. When using G9SX-SM for safety categories, be sure to confirm the conformity as a whole system.

Safety Category 4 (EN ISO13849-1)

- 1) Connect a fuse to each of the Standstill detection input lines.
- 2) Provide signals of different phases for the Standstill detection inputs (Z1-Z2, Z3-Z4).
- 3) Connect Guard lock Safety-door switches to any one of Safety Standstill detection outputs: ES1, ES2 or ES3.
- 4) Input the signal through a NC contact of the contactor to EDM input T31-T32. (Refer to *Application Examples* on page 57.)
- 5) Be sure to connect A2 to ground.

Standards Certification

G9SX-SM032-□

Standards/UL Certification

- Certified by TÜV-SUD
IEC/EN 61508 SIL3
IEC/EN 62061 SIL3
EN ISO13849-1 PL e/category 4
IEC/EN 61000-6-2
IEC/EN 61000-6-4
- Certified by UL
UL508
CAN/CSA C22.2 No.142

Directives

- EMC Directive
- Machinery Directive

G9SX Series Non-Contact Door Switch Controller G9SX-NS

Dedicated controller for Non-Contact Door Switch with programless and safety circuit configuration

- Up to 30 units of D40A-2/D40A/D40Z Compact Non-Contact Door Switch can be connected to a single Controller.
- Logical AND connection function provides easy system configuration for partial stop and complete stop.
- Programless.
- G9SX-NSA provides simultaneous inputs of a Non-Contact Door Switch and a conventional key-insertion type Safety Door Switch.



For the most recent information on models that have been certified for safety standards, refer to your OMRON website.

Be sure to read the *Safety Precautions* on page 90.

Model Number Structure

Model Number Legend

Non-Contact Door Switch Controller

G9SX - □□□□□□ - □□□□ - □□
 1 2 3 4 5 6

1. Functions

NS/NSA: Controller
 EX: Expansion Unit

2. Output Configuration (Instantaneous Safety Outputs)

2: 2 outputs
 4: 4 outputs

3. Output Configuration (OFF-delayed Safety Outputs)

0: None
 2: 2 outputs

4. Output Configuration (Auxiliary Outputs)

1: 1 output
 2: 2 outputs

5. Max. OFF-delay Time

Controller
 T03: 3 s (Variable)
 Expansion Unit
 Blank: No OFF delay
 T: OFF delay

6. Terminal Block Type

RT: Screw terminals
 RC: Spring-cage terminals

Ordering Information

List of Models

Non-Contact Door Switch Controllers

Safety outputs *1		Auxiliary outputs *3	Logical AND connection input	Logical AND connection output	Max. OFF delay time *4	Rated voltage	Terminal block type	Model
Instantaneous	OFF-delayed *2							
2 (Semi-conductors)	0	2 (Semi-conductors)	1	1	---	24 VDC	Screw terminals	G9SX-NS202-RT
	2 (Semiconductors)				3.0 s		Spring-cage terminals	G9SX-NS202-RC
							Screw terminals	G9SX-NSA222-T03-RT
							Spring-cage terminals	G9SX-NSA222-T03-RC

*1. P channel MOS FET transistor output

*2. The OFF-delayed output becomes an instantaneous output by setting the OFF-delay time to 0 s.

*3. PNP transistor output

*4. The OFF-delay time can be set in 16 steps as follows:

0/0.2/0.3/0.4/0.5/0.6/0.7/0.8/0.9/1.0/1.2/1.4/1.8/2.0/2.5/3.0 s

Expansion Units

Safety outputs		Auxiliary outputs	OFF-delay time	Rated voltage	Terminal block type	Model
Instantaneous	OFF-delayed					
4PST-NO	---	1 (Semiconductor) *1	---	24 VDC	Screw terminals	G9SX-EX401-RT
---	4PST-NO		*2		Spring-cage terminals	G9SX-EX401-RC
					Screw terminals	G9SX-EX041-T-RT
					Spring-cage terminals	G9SX-EX041-T-RC

*1. PNP transistor output

*2. The OFF-delay time is synchronized to the OFF-delay time setting in the connected Controller (G9SX-NSA222-T03-□).

Accessories

Terminal Block

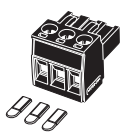
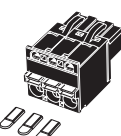
Appearance *	Specifications	Applicable units	Model	Remarks
	Terminal Block with screw terminals (3-pin)	G9SX-NSA	Y9S-03T1B-02A	Two Terminal Blocks (black) with screw terminals, and a set of six code marks to prevent erroneous insertion.
	Terminal Block with screw terminals (4-pin)	G9SX-NS G9SX-EX-□	Y9S-04T1B-02A	Two Terminal Blocks (black) with screw terminals, and a set of six code marks to prevent erroneous insertion.
	Terminal Block with spring-cage terminals (3-pin)	G9SX-NSA	Y9S-03C1B-02A	Two Terminal Blocks (black) with spring-cage terminals, and a set of six code marks to prevent erroneous insertion.
	Terminal Block with spring-cage terminals (4-pin)	G9SX-NS G9SX-EX-□	Y9S-04C1B-02A	Two Terminal Blocks (black) with spring-cage terminals, and a set of six code marks to prevent erroneous insertion.

Note: The G9SX main unit comes with a terminal block as standard equipment. The accessories shown here can be ordered as a replacement.

* The illustrations show 3-pin types

G9SX-NS

Specifications

Non-contact Door Switch Controllers

Ratings

Power input

Item	Model	G9SX-NS202-□	G9SX-NSA222-T03-□	G9SX-EX-□
Rated supply voltage		24 V DC		
Operating voltage range		-15% to 10% of rated supply voltage		
Rated power consumption *		3 W max.	4 W max.	2 W max.

* Power consumption of loads not included.

Inputs

Item	Model	G9SX-NS202-□/G9SX-NSA222-T03-□
Safety input *1		Operating voltage: 20.4 VDC to 26.4 VDC, internal impedance: approx. 2.8 kΩ *2
Feedback/reset input		

*1. Only applies to the G9SX-NSA222-T03-□. Refers to input other than that from the Non-contact Door Switch.

*2. Provide a current equal to or higher than that of the minimum applicable load of the connected input control device.

Outputs

Item	Model	G9SX-NS202-□/G9SX-NSA222-T03-□
Instantaneous safety output *1 OFF-delayed safety output *1		P channel MOS FET transistor output Load current: 0.8 A DC max. *2
Auxiliary output		PNP transistor output Load current: 100 mA max.

*1. While safety outputs are in the ON state, the following signal sequence is output continuously for diagnosis.

When using the safety outputs as input signals to control devices (i.e. Programmable Controllers), consider the OFF pulse shown below.

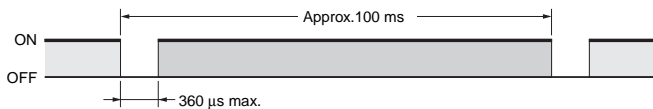

*2. The following derating is required when Units are mounted side-by-side.

G9SX-NS202-□/G9SX-NSA222-T03-□: 0.4 A max. load current

Expansion Unit

Item	Model	G9SX-EX-□
Rated load		250 VAC, 3 A/30 VDC, 3 A (resistive load)
Rated carry current		3 A
Maximum switching voltage		250 VAC, 125 VDC

Characteristics

Item	Model	G9SX-NS202-□	G9SX-NSA222-T03-□	G9SX-EX-□
Over-voltage category (IEC/EN 60664-1)		II		II (Relay outputs 13 to 43 and 14 to 44: III)
Operating time (OFF to ON state) *1		Logical AND connection input: 100 ms max. D40A-2/D40A connected: 100 ms max. D40Z connected: 200 ms max.	Safety input: 50 ms max. *2 Logical AND connection input: 100 ms max. *3 D40A-2/D40A connected: 100 ms max. *3 D40Z connected: 200 ms max. *3	30 ms max. *4
Response time (ON to OFF state) *1		15 ms max. (Logical AND connection input: OFF) Logical AND connection input: 15 ms max. D40A-2/D40A connected: 20 ms max. *6 D40Z connected: 45 ms max.	15 ms max. (Logical AND connection input: OFF) Safety input: 15 ms max. Logical AND connection input: 15 ms max. D40A-2/D40A connected: 20 ms max. *6 D40Z connected: 45 ms max.	10 ms max. *4
ON-state residual voltage		3.0 V max. (safety output, auxiliary output)		
OFF-state leakage current		0.1 mA max. (safety output, auxiliary output)		
Maximum wiring length of safety input, logical AND connection input, and Non-contact Door Switch input		100 m max. (External connection impedance: 100 Ω max. and 10 nF max.)		
Reset input time (Reset button pressing time)		100 ms min.		
Accuracy of OFF-delay time *5		---	Within ±5% of the set value	Within ±5% of the set value
Insulation resistance	Between logical AND connection terminals, and power supply input terminals and other input and output terminals connected together	20 MΩ min. (at 100 VDC)		---
	Between all terminals connected together and DIN rail			100 MΩ min. (at 500 VDC)
Dielectric strength	Between logical AND connection terminals, and power supply input terminals and other input and output terminals connected together	500 VAC for 1 min.		---
	Between all terminals connected together and DIN rail			1,200 VAC for 1 min
	Between different poles of outputs			
	Between relay outputs connected together and other terminals connected together	---		2,200 VAC for 1 min
Vibration resistance		10 to 55 to 10 Hz, 0.375 mm single amplitude (0.75 mm double amplitude)		
Shock resistance	Destruction	300 m/s ²		
	Malfunction	100 m/s ²		
Durability	Electrical	---		100,000 cycles min. rated load, switching frequency: 1,800 cycles/hour)
	Mechanical	---		5,000,000 cycles min. (switching frequency: 7,200 cycles/hour)
Ambient operating temperature		-10 to 55°C (no icing or condensation)		
Ambient operating humidity		25% to 85%		
Terminal tightening torque		0.5 N·m (For the G9SX-NS□-RT (with screw terminals) only)		
Weight		Approx. 125 g	Approx. 200 g	Approx. 165 g

*1. When two or more Units are connected by logical AND, the operating time and response time are the sum total of the operating times and response times, respectively, of all the Units connected by logical AND.

The operating time/response time of the Non-contact Door Switch are included of the time with the D40A-2/D40A/D40Z.

*2. Represents the operating time when the safety input turns ON with all other conditions set.

*3. Represents the operating time when the logical AND input and the Non-contact Door Switch input turn ON with all other conditions set.

*4. This does not include the operating time or response time of G9SX-NS□ that are connected.

*5. This does not include the operating time or response time of internal relays in the G9SX-EX-□.

*6. The failure detection time for 24 V short-circuit failure on the input to Non-contact Door Switches is 35 ms max.

If using the Switch for an application other than as a Door Switch, calculate the safe distance using a failure detection time of 35 ms.

Logical AND Connection

Item	Model	G9SX-NS202-□	G9SX-NSA222-T03-□	G9SX-EX-□
Number of Units connected per logical AND output		4 Units max.		---
Total number of Units connected by logical AND *1		20 Units max.		---
Number of Units connected in series by logical AND		5 Units max.		---
Max. number of Expansion Units connected *2			---	5 Units max.
Maximum cable length for logical AND input		100 m max.		---

Note: See Logical AND Connection Combinations below for details.

*1. The number of G9SX-EX401-□ Expansion Units or G9SX-EX041-T-□ Expansion Units (OFF-delayed Model) not included.

*2. G9SX-EX401-□ Expansion Units and G9SX-EX041-T-□ Expansion Units (OFF-delayed Model) can be mixed.

Logical AND Connection Combinations

- One logical AND connection output from a G9SX-NS□ Controller can be logically AND connected to up to four Controllers.

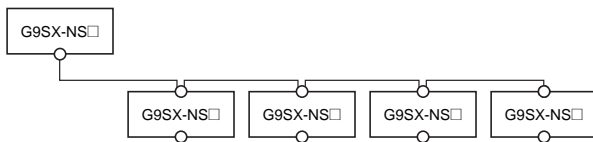

- Any G9SX-NS□ Controller that receives a logical AND connection input can be logically connected to other Controllers on up to five layers.

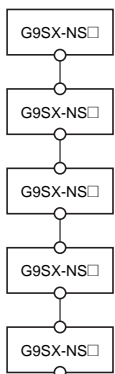

Note: The G9SX-NS□ in the above diagram can be replaced by the G9SX-AD□ Advanced Unit. For details on G9SX-AD□ advanced unit, refer to G9SX Flexible Safety Unit on your OMRON website.

- The largest possible system configuration contains a total of 20 G9SX-NS□ Controllers, G9SX-AD□ Advanced Units, and G9SX-BC Basic Units. In this configuration, each Controller or Advanced Unit can have up to five Expansion Units.

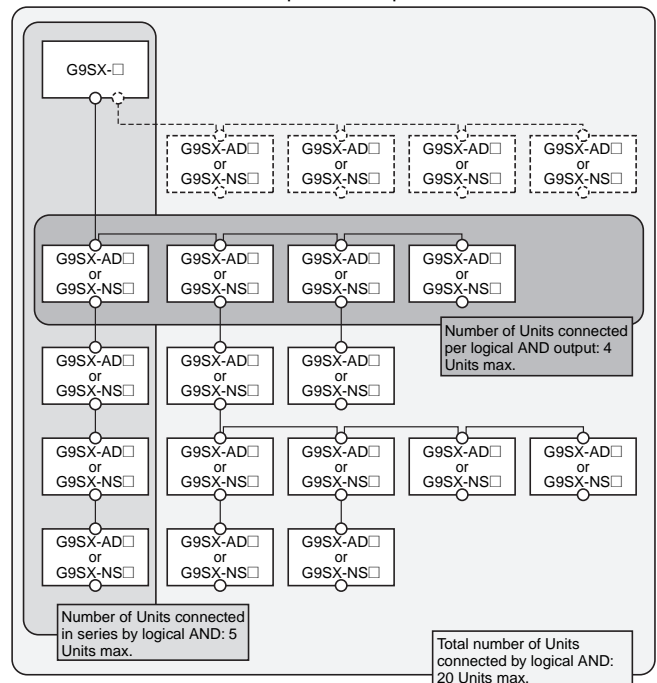

Response Time and Operating Time

1. G9SX-NS□

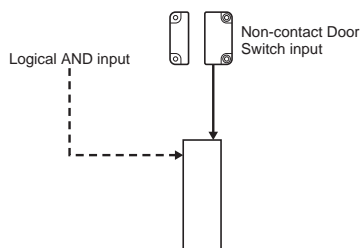

	Max. response time (excluding Expansion Units) *1	Max. operating time (excluding Expansion Units) *2
Non-contact Door Switch input	D40A-2/D40A connected: 20 ms max. *3 D40Z connected: 45 ms max. *3	D40A-2/D40A connected: 100 ms max. *4 D40Z connected: 200 ms max. *4
Logical AND input	15 ms	100 ms

*1. The maximum response time is the time it takes the output to switch from ON to OFF after the input switches from ON to OFF.

*2. The maximum operating time is the time it takes the output to switch from OFF to ON after the input switches from OFF to ON.

*3. Represents the response time of Non-contact Door Switch (1 to 30 units connected) and the response time of G9SX-NS added.

*4. Represents the operating time of Non-contact Door Switch (1 to 30 units connected) and the operating time of G9SX-NS added.

2. G9SX-NSA□

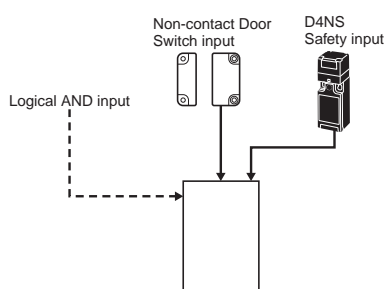

	Max. response time (excluding Expansion Units) *1	Max. operating time (excluding Expansion Units) *2
Non-contact Door Switch input	D40A-2/D40A connected: 20 ms max. *3 D40Z connected: 45 ms max. *3	D40A-2/D40A connected: 100 ms max. *4 D40Z connected: 200 ms max. *4
Safety input	15 ms	50 ms
Logical AND input	15 ms	100 ms

*1. The maximum response time is the time it takes the output to switch from ON to OFF after the input switches from ON to OFF.

*2. The maximum operating time is the time it takes the output to switch from OFF to ON after the input switches from OFF to ON.

*3. Represents the response time of Non-contact Door Switch (1 to 30 units connected) and the response time of G9SX-NS added.

*4. Represents the operating time of Non-contact Door Switch (1 to 30 units connected) and the operating time of G9SX-NS added.

3. Multiple G9SX-NS□/NSA□ Non-contact Door Switch Controllers

When multiple Controllers are logically connected with AND connections, the response time is the sum of the response times given in 1 and 2 above. (It is the same for the operating time.)

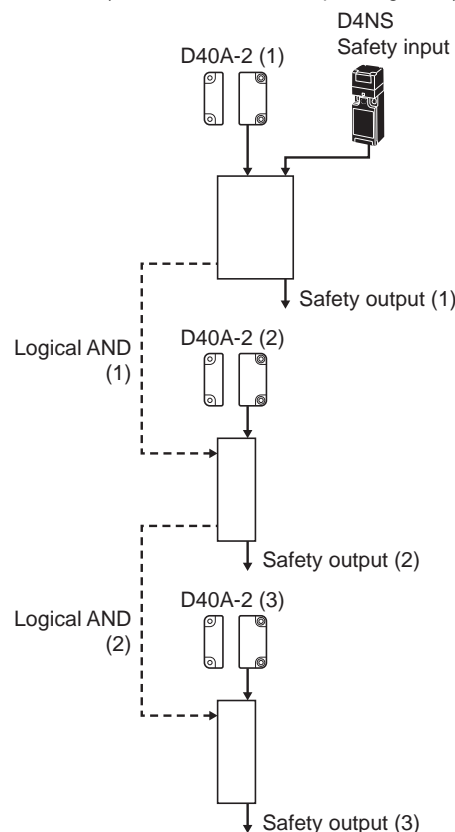

Case (a)

Response Time from When D40A-2 (1) Turns from ON to OFF until Safety Output (2) Turns from ON to OFF

$$20 \text{ ms (D40A-2 (1))} + 15 \text{ ms (Logical AND connection (1))} = 35 \text{ ms}$$

Note: 1. 20 ms + 15 ms = 35 ms when D40A is connected.
2. 45 ms + 15 ms = 60 ms when D40Z is connected.

Case (b)

Response Time from When D4NS Turns from ON to OFF until Safety Output (3) Turns from ON to OFF

$$15 \text{ ms (D4NS)} + 15 \text{ ms (Logical AND connection (1))} + 15 \text{ ms (Logical AND connection (2))} = 45 \text{ ms}$$

G9SX-NS

Connections

Internal Connection

G9SX-NS202-□ (Non-contact Door Switch Controller)

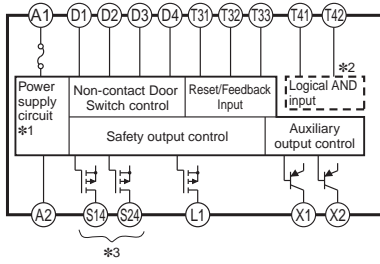

- *1. Internal power supply circuit is not isolated.
- *2. Logical AND input is isolated.
- *3. Outputs S14 to S24 are internally redundant.

G9SX-EX401-□/G9SX-EX041-T-□ (Expansion Unit/Expansion Unit OFF-delayed Model)

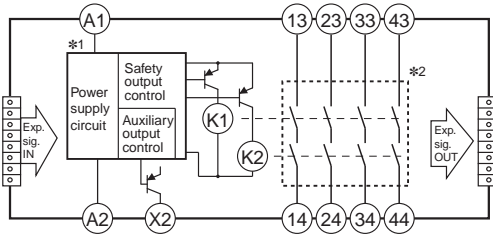

- *1. Internal power supply circuit is not isolated.
- *2. Relay outputs are isolated.

G9SX-NSA222-T03-□ (Non-contact Door Switch Controller)

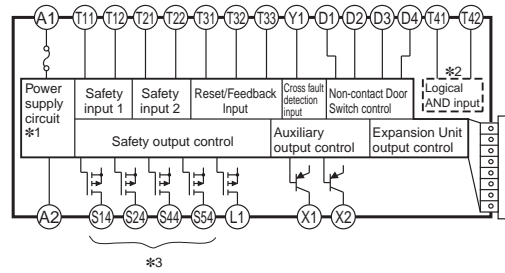

- *1. Internal power supply circuit is not isolated.
- *2. Logical AND input is isolated.
- *3. Outputs S14 to S54 are internally redundant.

D40A-2 and G9SX-NS□ Wiring

Connecting the D40A-2 to the G9SX-NS allows for PLe and Category 4 compliance.

Multiple switch connection

Maximum 30 switches can be connected in series.

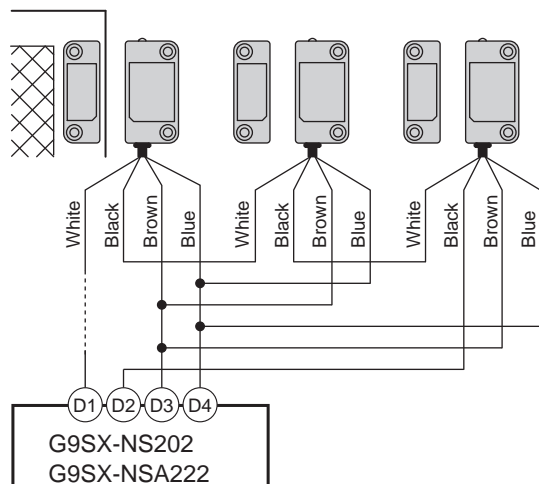

Single switch connection

D40A-□2C□

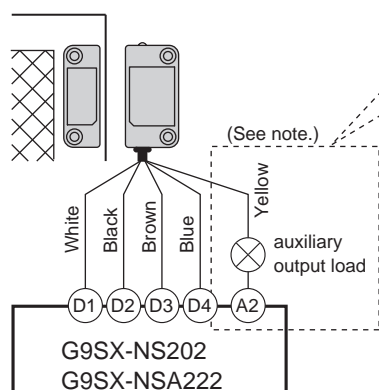

Note. D40A-□2D□

The auxiliary output of D40A-□2D□ supports the input polarity of both PNP and NPN.

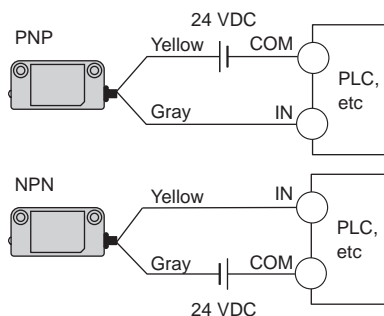

Wiring

Signal Name		Wiring color	Pin number	Description of operation
Safety door switch power input	+	Brown	1	Power supply for D40A-2□. Connect to D3 terminal and D4 terminal on G9SX-NS□.
	-	Blue	3	
Safety door switch signal input		White	2	Input designated signal from G9SX-NS□. To set safety door switch output in ON state, safety door switch input must be in ON state.
Safety door switch output		Black	4	Output status depends on actuator status and safety door switch input state.
Auxiliary output		Yellow	5	Output when sensor detect actuator.
		Gray	---	

Note: 1. When connecting a XS2F series connector with cable to a connector type, the color of the auxiliary output cable is gray.
2. For details, refer to the data sheet of each Non-contact Door Switch.

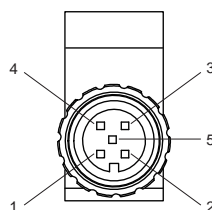

Pin arrangement of D40A-2 connector type

D40A, D40Z and G9SX-NS□ Wiring

Example: Wiring a Single Switch

D40A

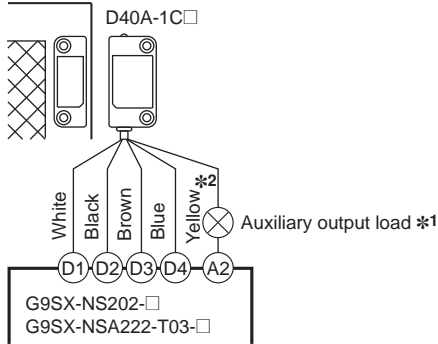

D40Z

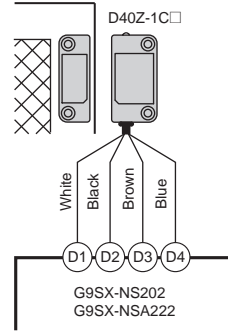

*1. The auxiliary output load current must be 10 mA max.

*2. When connecting a XS2F series connector with cable to a connector type, the color of the auxiliary output cable is gray.

Example: Wiring Multiple Switches

Connect Up to 30 Non-contact Door Switches

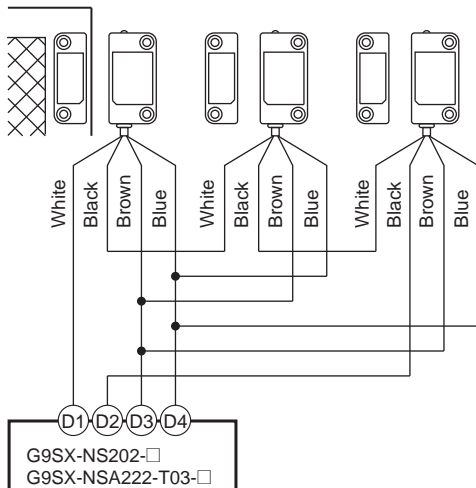

Example of auxiliary outputs of the D40Z

The auxiliary output of the D40Z supports the input polarities of both PNP and NPN.

PNP

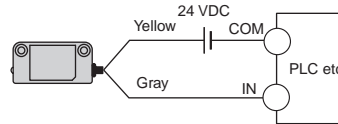

NPN

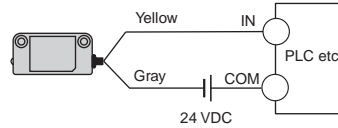

Note: The auxiliary output load current must be 10 mA max. Wrong connection may lead to a failure of the auxiliary output circuit.

Wiring of Inputs and Outputs

Signal name	Cable color of D40A/D40Z	Pin No. of D40A connector type	Description of operation
Non-contact Door Switch power supply input	+	Brown	Supplies power to the D40A or D40Z. Connect to the D3 and D4 terminal of the G9SX-NS□.
	-	Blue	
Non-contact Door Switch input	White	2	Inputs signals from the G9SX-NS□. The Non-contact Door Switch input must be ON as a required condition for the Non-contact Door Switch output to be ON.
Non-contact Door Switch output	Black	4	Turns ON and OFF according to actuator detection and the status of the Non-contact Door Switch input.
Auxiliary output	Yellow	---	Turns ON when actuator is detected.
	Gray	5	When a fault is detected, turns into OFF state regardless of actuator status. *3

Note: 1. When connecting a XS2F series connector with cable to a D40A connector type, the cable color of the auxiliary output is gray.

2. For details, refer to the data sheet of each Non-contact Door Switch.

*3. Only D40Z turns into OFF state when a fault is detected by the actuator.

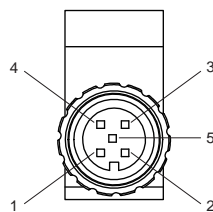

Pin arrangement of D40A connector type

Wiring of Inputs and Outputs

G9SX-NS202-□

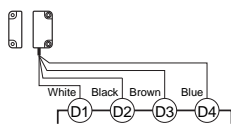
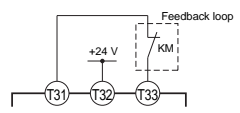
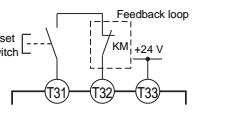
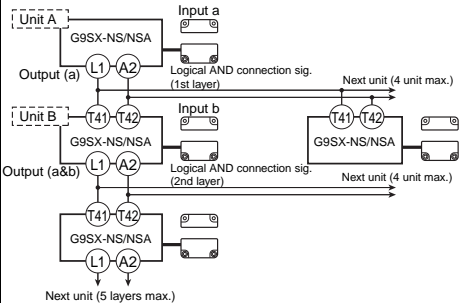
Signal name	Terminal name	Description of operation	Wiring
Power supply input	A1, A2	Connect the power source to the A1 and A2 terminals.	Connect the power supply plus (24 VDC) to the A1 terminal. Connect the power supply minus (GND) to the A2 terminal.
Non-contact Door Switch input	D1, D2, D3, D4	All Non-contact Door Switch inputs connected to the G9SX-NS□ must be ON as a required condition for the safety outputs to be ON. Otherwise the safety outputs cannot be in the ON state.	
Feedback/reset input	T31, T32, T33	To set the safety outputs in the ON state, the ON state signal must be input to T33. Otherwise the safety outputs cannot be in the ON state.	Auto reset 
		To set the safety outputs in the ON state, the signal input to T32 must change from the OFF state to the ON state, and then to the OFF state. Otherwise the safety outputs cannot be in the ON state.	Manual reset 
Logical AND connection input	T41, T42	A logical AND connection means that one unit (Unit A) outputs a safety signal "a" to a subsequent unit (Unit B) and Unit B calculates the logical AND (i.e., outputs the AND) of the signal "a" and safety signal "b", which is input to Unit B. Thereby the logic of the safety output of Unit B is (AND). (An AND of inputs "a" and "b" is output.) To set the safety outputs of the subsequent Unit in the ON state, its logical AND connection preset switch must be set to AND (enable) and the high signal must be input to T41 of the subsequent unit.	
Instantaneous safety output	S14, S24	Turns ON/OFF according to the state of the safety inputs, Non-contact Door Switch inputs, feedback/reset inputs, and logical AND connection inputs.	Keep these outputs open when not used.
Logical AND connection output	L1	Outputs a signal of the same logic and at the same time as the instantaneous safety outputs.	Keep these outputs open when not used.
Auxiliary monitor output	X1	Outputs a signal of the same logic and at the same time as the instantaneous safety outputs.	Keep these outputs open when not used.
Auxiliary error output	X2	Outputs when the error indicator is lit or flashing.	Keep these outputs open when not used.

G9SX-NSA222-T03-□

Signal name	Terminal name	Description of operation	Wiring	
Power supply input	A1, A2	Connect the power source to the A1 and A2 terminals.	Connect the power supply plus (24 VDC) to the A1 terminal. Connect the power supply minus (GND) to the A2 terminal.	
Safety input 1	T11, T12	To set the safety outputs in the ON state, the high state signals must be input to both safety input 1 and safety input 2. Otherwise the safety outputs cannot be in the ON state.	Using safety input 1 system	
			Using safety input 2 system (without short-circuit monitoring between systems)	
Safety input 2	T21, T22		Using safety input 2 system (with short-circuit monitoring between systems)	
Non-contact Door Switch input	D1, D2, D3, D4	All Non-contact Door Switch inputs connected to the G9SX-NS must be ON as a required condition for the safety outputs to be ON. Otherwise the safety outputs cannot be in the ON state.		
Feedback/reset input	T31, T32, T33	To set the safety outputs in the ON state, the ON state signal must be input to T33. Otherwise the safety outputs cannot be in the ON state. To set the safety outputs in the ON state, the signal input to T32 must change from the OFF state to the ON state, and then to the OFF state. Otherwise the safety outputs cannot be in the ON state.	Auto reset	
			Manual reset	
Logical AND connection input	T41, T42	A logical AND connection means that one unit (Unit A) outputs a safety signal "a" to a subsequent unit (Unit B) and Unit B calculates the logical AND (i.e., outputs the AND) of the signal "a" and safety signal "b", which is input to Unit B. Thereby the logic of the safety output "b" is output.) To set the safety outputs of the subsequent Unit in the ON state, its logical AND connection preset switch must be set to AND (enable) and the high signal must be input to T41 of the subsequent unit.		
Cross fault detection input	Y1	Selects the mode for the failure detecting (cross fault detecting) function for the safety inputs of G9SX corresponding to the connection of the cross fault detection input.	Whether Y1 is connected depends on whether the T11 and T21 terminals are used. Refer to wiring information for safety inputs 1 and 2.	
Instantaneous safety output	S14, S24	Turns ON/OFF according to the state of the safety inputs, feedback/reset inputs, and logical AND connection inputs. During OFF-delay state, the Instantaneous safety outputs are not able to turn ON.	Keep these outputs open when not used.	
OFF-delayed safety output	S44, S54	OFF-delayed safety outputs. The OFF-delay time is set by the OFF-delay preset switch. When the delay time is set to zero, these outputs can be used as non-delay outputs.	Keep these outputs open when not used.	
Logical AND connection output	L1	Outputs a signal of the same logic and at the same time as the instantaneous safety outputs.	Keep these outputs open when not used.	
Auxiliary monitor output	X1	Outputs a signal of the same logic and at the same time as the instantaneous safety outputs.	Keep these outputs open when not used.	
Auxiliary error output	X2	Outputs when the error indicator is lit or flashing.	Keep these outputs open when not used.	

Dimensions and Terminal Arrangement

Non-contact Door Switch Controller

G9SX-NS202-□

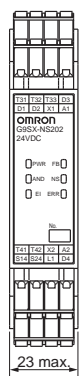
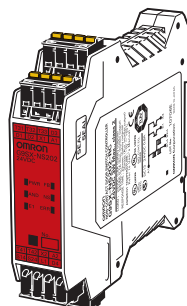

23 max.
(22.5) *

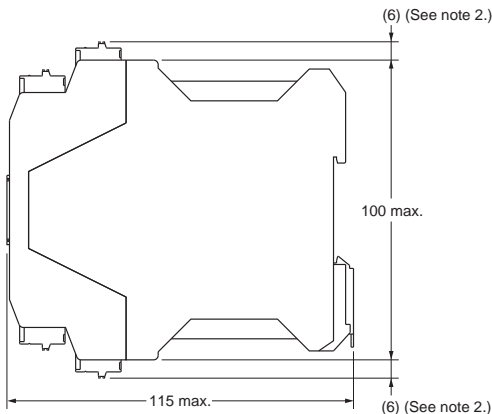

Terminal arrangement

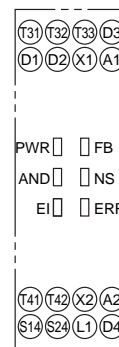

PWR □ □ FB
AND □ □ NS
EI □ □ ERR

Note: 1. Above outline drawing is for models with spring-cage terminals (-RC).
2. For models with spring-cage terminals (-RC) only.

* Typical dimension

Non-contact Door Switch Controller

G9SX-NSA222-T03-□

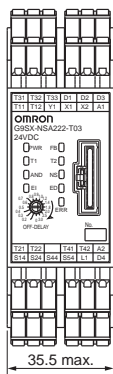
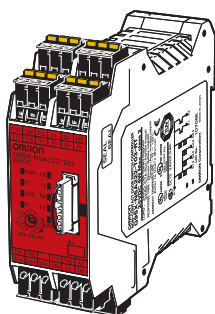

35.5 max.
(35) *

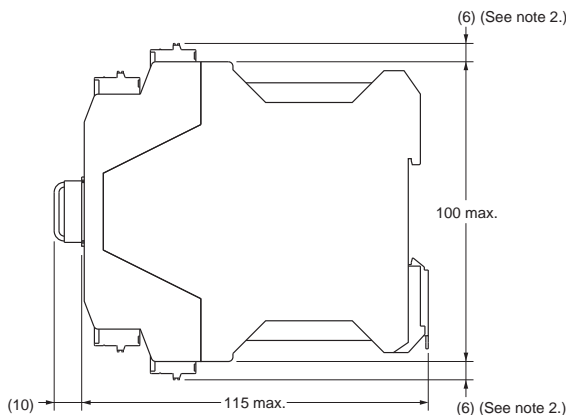

Terminal arrangement

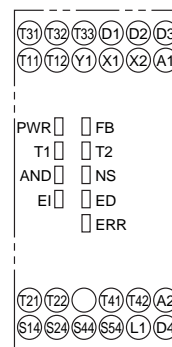

PWR □ □ FB
T1 □ □ T2
AND □ □ NS
EI □ □ ED
□ □ ERR

Note: 1. Above outline drawing is for models with spring-cage terminals (-RC).
2. For models with spring-cage terminals (-RC) only.

* Typical dimension

Expansion Unit

G9SX-EX401-□

Expansion Unit (OFF-delayed Model)

G9SX-EX041-T-□

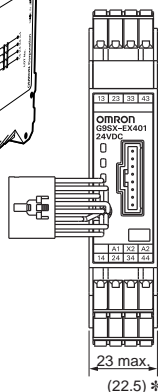
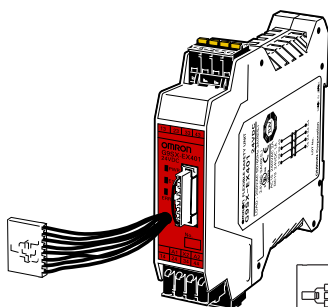

23 max.
(22.5) *

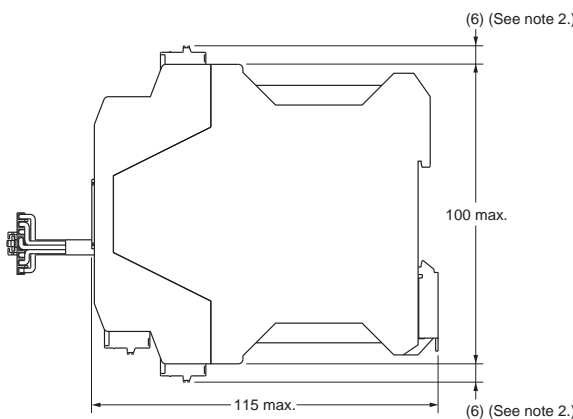

Terminal arrangement

G9SX-EX401-□ (Expansion Unit) G9SX-EX041-T-□ (Expansion Unit with OFF Delay)

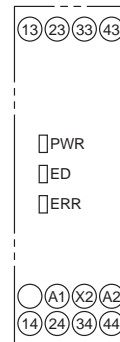
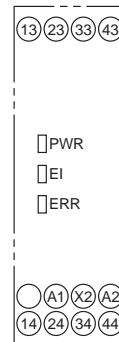

Note: 1. Above outline drawing is for models with spring-cage terminals (-RC).
2. For models with spring-cage terminals (-RC) only.

* Typical dimension

Functions

Logical AND Connection

A logical AND connection means that the G9SX outputs a safety signal "a" to another G9SX, and that G9SX creates the logical AND of safety signal "a" and safety signal "b." The safety output of the G9SX-NSA222-T03-□ with the logical AND connection shown in the following diagram is "a" AND "b."

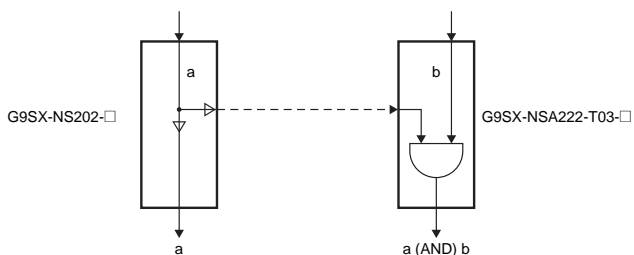

This is illustrated using the application in the following diagram as an example. The equipment here has two hazards identified as Robot 1 and Robot 2, and it is equipped with Non-contact Door Switches and an emergency stop button as safety measures. If the door to Robot 2 is opened, only Robot 2 is stopped (i.e., a partial stop). If the door to Robot 1 is opened or the emergency stop button is pressed, both Robot 1 and Robot 2 stop (i.e., a complete stop).

The actual situation using a G9SX for this application is shown in this example.

Note: The logical AND setting on the G9SX-NS202-□ must be set to AND (enabled).

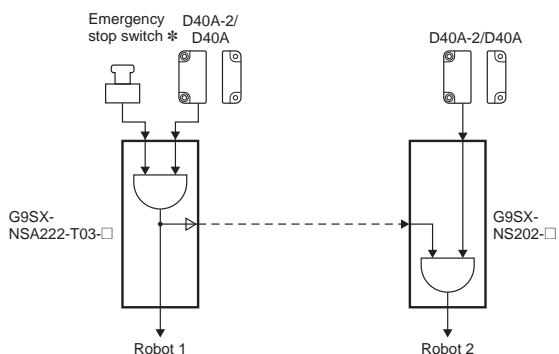
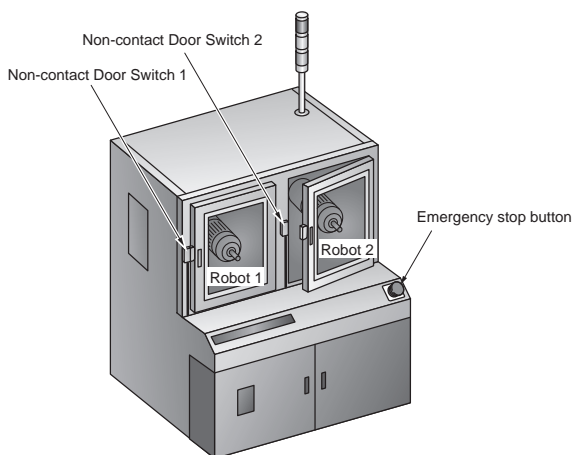

* A manual reset is required when an emergency stop is used.

Connecting Expansion Units

- The G9SX-EX and G9SX-EX-T Expansion Units can be connected to a G9SX-NSA222-T3-□ Non-contact Door Switch Controller to increase the number of safety outputs. (They cannot be connected to a G9SX-NS202-□.)
- A maximum of five Expansion Units can be connected to one G9SX-NSA222-T03-□. This may be a combination of G9SX-EX instantaneous models and G9SX-EX-T OFF-delayed models.
- Remove the terminating connector from the receptacle on G9SX-NSA222-T03-□ and insert the Expansion Unit cable connector into the receptacle. Insert the terminating connector into the receptacle on the Expansion Unit at the very end (rightmost).
- When Expansion Units are connected to a Controller, make sure that power is supplied to every Expansion Unit. (Refer to the following diagram for actual Expansion Unit connection.)

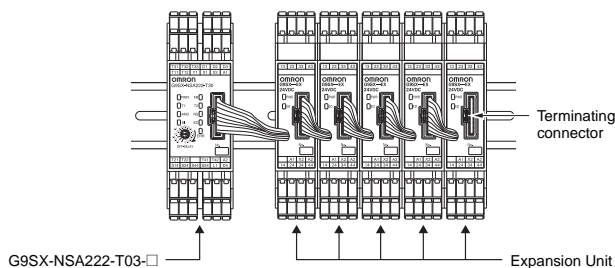

Setting Procedure

1. Cross Fault Detection (G9SX-NSA222-T03-□)

Set the cross fault detection mode for safety inputs by shorting Y1 to 24 V or leaving it open.

When cross fault detection is set to ON, short-circuit failures are detected between safety inputs T11-T12 and T21-22. When a cross fault is detected, the following will occur.

- (1) The safety outputs and logical AND outputs lock out.
- (2) The LED error indicator is lit.
- (3) The error output (auxiliary output) turns ON.

Cross fault detection	Wiring	
OFF	Using safety input 1 system	
	Using safety input 2 system	
ON		

2. Reset Mode (G9SX-NS202-□/NSA222-T03-□)

Set the reset mode using feedback/reset input terminals T31, T32, and T33.

Auto reset mode is selected when terminal T32 is shorted to 24 V and manual reset mode is selected when terminal T33 is shorted to 24 V.

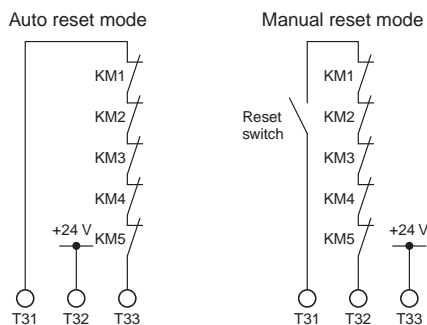

3. Setting Logical AND Connection (G9SX-NS202-□/NSA222-T03-□)

When connecting two or more Non-contact Door Switch Controllers by logical AND connection, set the logical AND connection preset switch on the Controller that is on the input side (Unit B in the following diagram) to AND. The default setting of the logical AND connection preset switch is set to OFF.

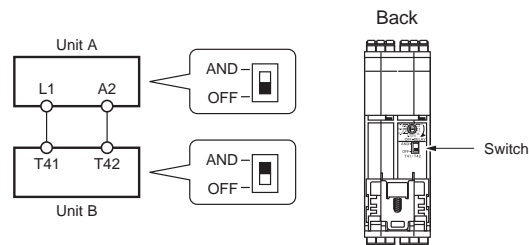

Note: A setting error will occur and Unit B will lock out if the logical AND setting switch on the Unit B is set to OFF.

4. Setting the OFF-delay Time (G9SX-NSA222-T03-□)

The OFF-delay preset time on G9SX-NSA222-T03-□ is set from the OFF-delay time preset switch (1 each on the front and back of the Unit).

Normal operation will only occur if both switches are identically set. An error will occur if the switches are not identically set. The default setting of the OFF-delay time preset switch is set to 0 s.

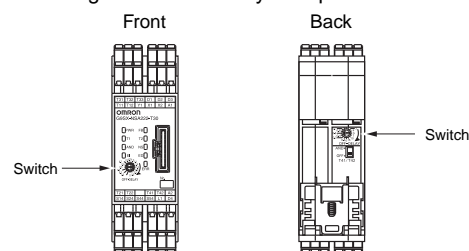

Refer to the following illustration for details on setting switch positions.

G9SX-NSA222-T03-□

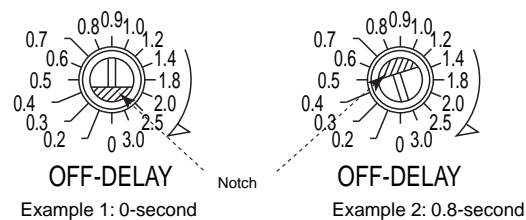

LED Indicators

Marking	Color	Name	G9SX-NS202	G9SX-NSA222	G9SX-EX	G9SX-EX-T	Function	Reference
PWR	Green	Power supply indicator	○	○	○	○	Lights while power is supplied.	---
T1	Orange	Safety input #1 indicator	---	○	---	---	Lights while a high signal is input to T12. Flashes when an error relating to safety input #1 occurs.	*
T2	Orange	Safety input #2 indicator	---	○	---	---	Lights while a high signal is input to T22. Flashes when an error relating to safety input #2 occurs.	
NS	Orange	Non-contact Door Switch input indicator	○	○	---	---	Lights when the Non-contact Door Switch input turns ON. Flashes when an error relating to the Non-contact Door Switch input occurs.	
FB	Orange	Feedback/reset input indicator	○	○	---	---	Lights in the following cases: With automatic reset while a high signal is input to T33. With manual reset while a high signal is input to T32. Flashes when an error relating to feedback/reset input occurs.	
AND	Orange	Logical AND input indicator	○	○	---	---	Lights while a high signal is input to T41. Flashes when an error relating to logical AND connection input occurs.	
EI	Orange	Instantaneous safety output indicator	○	○	○	---	Lights while the Instantaneous safety outputs (S14, S24, S34) are in the ON state. Flashes when an error relating to the instantaneous safety output occurs.	
ED	Orange	OFF-delayed safety output indicator	---	○	---	○	Lights while OFF-delayed safety outputs (S44, S54) are in the ON-state. Flashes when an error relating to OFF-delayed safety output occurs.	
ERR	Red	Error indicator	○	○	○	○	Lights or flashes when an error occurs.	

* Refer to "Fault Detection" on the next page for details.

Settings Indication (at Power ON)

Settings for the G9SX can be checked by the orange indicators for approx. 3 seconds after the power is turned ON. During this settings indication period, the ERR indicator will light, however the auxiliary error output will remain OFF.









Indicator	Item	Setting position	Indicator status	Setting mode	Setting status
T1	Cross fault detection mode	Y1 terminal	Lit	Detection mode	Y1 = open
			Not lit	Non-detection mode	Y1 = 24 VDC
FB	Reset mode	T32 or T33 terminal	Lit	Manual reset mode	T33 = 24 VDC
			Not lit	Auto reset mode	T32 = 24 VDC
AND	Logical AND connection input mode	Logical AND connection preset switch	Lit	Enable logical AND input	AND
			Not lit	Disable logical AND input	OFF



Fault Detection

When the Non-contact Door Switch Controller detects a fault, the ERR indicator and/or other indicators light up or flash to inform the user about the fault.



Check and take necessary measures referring to the following table, and then re-supply power to the Non-contact Door Switch Controller.

(G9SX-NS202-□/NSA222-T03-□)

ERR indicator	Other indicator	Fault	Expected causes of the fault	Check points and measures to take
 Flashes	---	Fault due to electromagnetic disturbance or of internal circuits.	<ol style="list-style-type: none"> Excessive electromagnetic disturbance Failure of the internal circuit 	<ol style="list-style-type: none"> Check the disturbance level around the G9SX and the related system. Replace with a new product.
 Lights	 T1 flashes	Fault involved with safety input 1	<ol style="list-style-type: none"> Error in the wiring of safety input 1 Incorrect setting of cross fault detection input Failure of the circuit of safety input 1 	<ol style="list-style-type: none"> Check the wiring to T11 and T12. Check the wiring to Y1. Replace with a new product.
	 T2 flashes	Fault involved with safety input 2	<ol style="list-style-type: none"> Error in the wiring of safety input 2 Incorrect setting of cross fault detection input Failure of the circuit of safety input 2 	<ol style="list-style-type: none"> Check the wiring to T21 and T22. Check the wiring to Y1. Replace with a new product.
	 NS flashes	Fault involved with Non-contact Door Switch input	<ol style="list-style-type: none"> Error in the wiring of Non-contact Door Switch input Error in the wiring of Non-contact Door Switch inputs in series connections. Failure of the internal circuits of Non-contact Door Switch inputs Failure of the Non-contact Door Switch 	<ol style="list-style-type: none"> Check the wiring to D1 and D2. Check the wiring to the Non-Contact Door Switch. Replace with a new product. Replace with a new Non-Contact Door Switch.
	 FB flashes	Fault involved with feedback/reset inputs	<ol style="list-style-type: none"> Error in the wiring of feedback/reset input. Failure of the circuit of feedback/reset input 	<ol style="list-style-type: none"> Check the wiring to T31, T32 and T33. Replace with a new product.
		Fault in Expansion Unit	<ol style="list-style-type: none"> Improper feedback signals from Expansion Unit Abnormal supply voltage to Expansion Unit Failure of the circuit of safety relay contact outputs 	<ol style="list-style-type: none"> Check the connecting cable of Expansion Unit and the connection of the termination socket. Check the supply voltage to Expansion Unit. Note: Make sure that all Expansion Units' PWR indicators are lit. Replace with a new product.
	 EI flashes	Fault involved with instantaneous safety outputs, logical AND connection outputs, or auxiliary monitor output	<ol style="list-style-type: none"> Error in the wiring of instantaneous safety outputs Failure of the circuit of instantaneous safety outputs Error in the wiring of the logical AND connection output Failure of the circuit of the logical AND connection output Error in the wiring of the auxiliary monitor output Impermissible high ambient temperature 	<ol style="list-style-type: none"> Check the wiring to S14 and S24. Replace with a new product. Check the wiring to L1. Replace with a new product. Check the wiring to X1. Check the ambient temperature and spacing around the G9SX.
 ED flashes	Fault involved with OFF-delayed safety outputs	<ol style="list-style-type: none"> Error in the wiring of OFF-delayed safety relay contact outputs Incorrect set values for OFF-delay time Failure of the circuit of OFF-delayed safety relay contact outputs Impermissible high ambient temperature 	<ol style="list-style-type: none"> Check the wiring to S44 and S54. Check the settings of the OFF-delay time setting switch. Replace with a new product. Check the ambient temperature and spacing around the G9SX. 	

ERR indicator	Other indicator	Fault	Expected causes of the fault	Check points and measures to take
● Lights	 AND flashes	Fault involved with logical AND connection input	<ol style="list-style-type: none"> 1. Error in the wiring of the logical AND connection input 2. Incorrect setting for the logical AND connection input 3. Failure of the circuit of the logical AND connection input 	<ol style="list-style-type: none"> 1. Check the wiring to T41 and T42. Note: 1. Make sure that the wiring length for the T41, T42 terminal is 100 meters or less. 2. Make sure that the logical AND connection signal is branched for 4 units or fewer. 2. Confirm the set value of the logical AND connection preset switch. 3. Replace with a new product.
	 All indicators except PWR flash	Supply voltage outside the rated value	<ol style="list-style-type: none"> 1. Supply voltage outside the rated value 	<ol style="list-style-type: none"> 1. Check the supply voltage to the Units.

When indicators other than the ERR indicator flash, check and take necessary actions referring to the following table.

ERR indicator	Other indicators	Fault	Expected cause of the fault	Check points and measures to take			
○ Off	<table border="1"> <tr> <td>T1</td> <td rowspan="2"></td> </tr> <tr> <td>T2</td> </tr> </table>	T1		T2	Mismatch between input 1 and input 2.	The input status between input 1 and input 2 is different, due to contact failure or a short circuit of safety input device(s) or a wiring fault.	Check the wiring from safety input devices to the G9SX. Or check the input sequence of safety input devices. After removing the fault, turn both safety inputs 1 and 2 to the OFF state.
T1							
T2							

(Expansion Unit)

ERR indicator	Other indicators	Fault	Expected cause of the fault	Check points and measures to take
● Lights	---	Fault involved with safety relay outputs of Expansion Units	<ol style="list-style-type: none"> 1. Welding of relay contacts 2. Failure of the internal circuit 	Replace with a new product.

Application Examples

Connection example with D40A-2

Highest achievable PL/category	Model	Stop category	Reset
PLe/4 equivalent	Non-contact Safety Door Switch D40A-2 Emergency stop pushbutton A165E/A22E Non-contact Door Switch Controller G9SX-NSA222-T03-□	0	Manual

Note: The above PL is only the evaluation result of the example. The PL must be evaluated in an actual application by the customer after confirming the usage conditions.

Application Overview

- The power supply to the motor M1 is turned OFF immediately when the emergency stop switch S1 is pressed.
- The power supply to the motor M1 is turned OFF immediately when the S2 detects that the guard is opened.
- The power supply to the motor M1 is kept OFF until the reset switch S3 is pressed while the guard is closed and the emergency stop switch S1 is released.

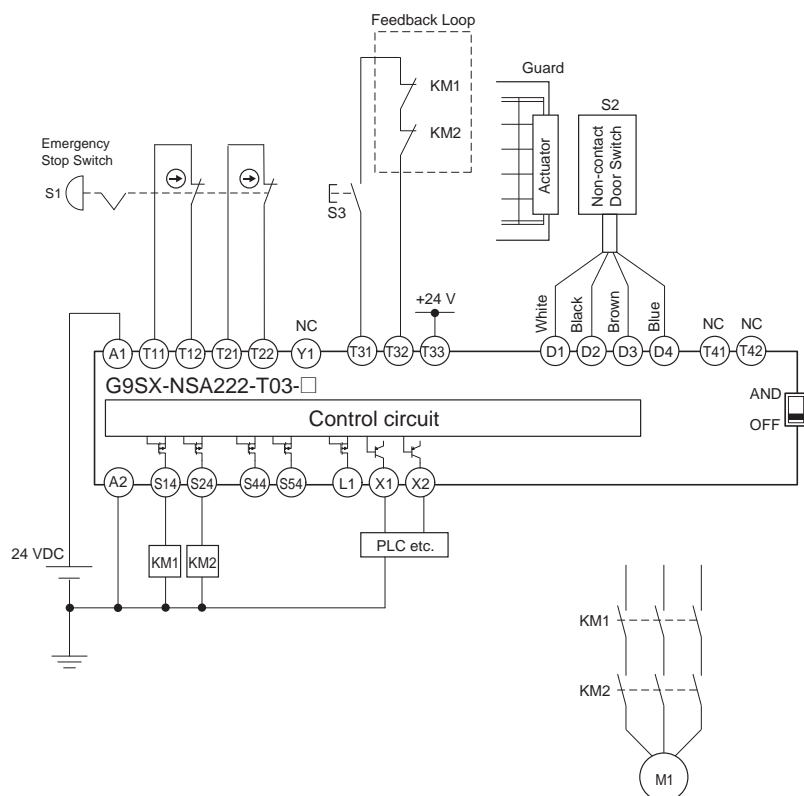

- S1: Emergency Stop Switch
- S2: Non-contact Safety Door Switch (D40A-2)
- S3: Reset switch
- KM1, KM2: Magnetic contactor
- M1: Motor

Timing chart

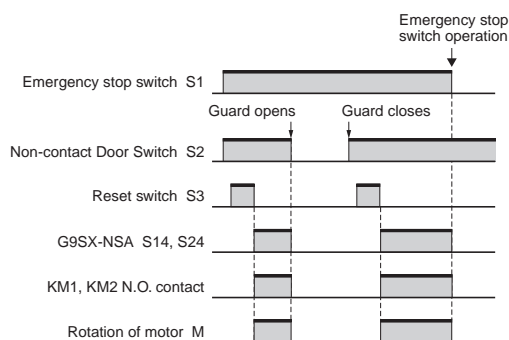

Note: For details on Non-contact Door Switch wiring, refer to page 75 or to the Instruction Sheet.

Example 1: Connection with D40A

Highest achievable PL/category	Model	Stop category	Reset
PLd/3 equivalent	Emergency Stop Switch A165E/A22E Non-contact Door Switch D40A Non-contact Door Switch Controller G9SX-NSA222-T03-□	0	Manual

Note: The PL evaluation result on this connection example applies to safety functions related to the D40A Non-Contact Door Switch. The above PL is only the evaluation result of the example. The PL must be evaluated in an actual application by the customer after confirming the usage conditions.

● Application Overview

- The power supply to the motor M is turned OFF immediately when the emergency stop switch S1 is pressed.
- The power supply to the motor M is turned OFF immediately when the S2 detects that the guard is opened.
- The power supply to the motor M is kept OFF until the reset switch S3 is pressed while the guard is closed and the emergency stop switch S1 is released.

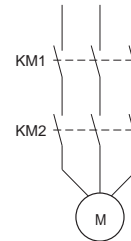
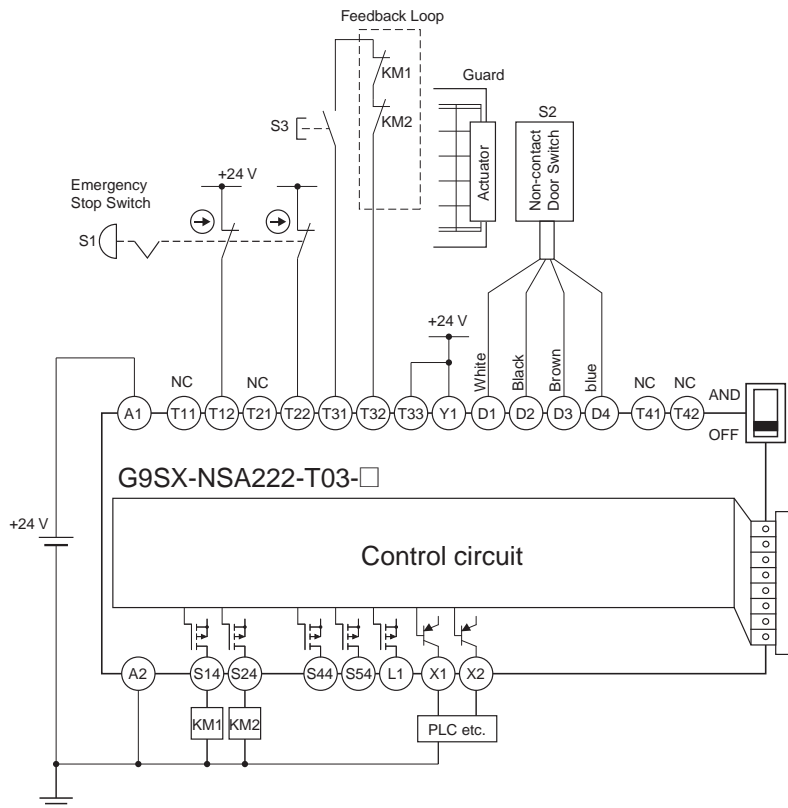

- S1: Emergency Stop Switch
- S2: Non-contact Door Switch (D40A)
- S3: Reset Switch
- KM1, KM2: Magnetic contactor
- M: Motor

Timing chart

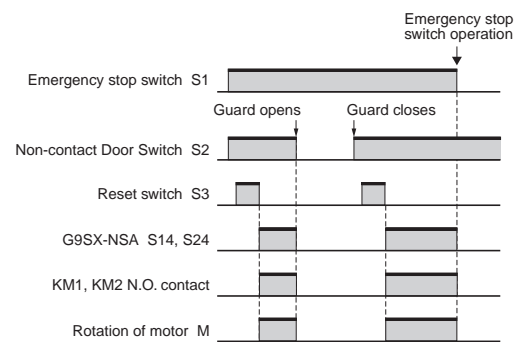

Note: For details on Non-contact Door Switch wiring, refer to page 76 or to the Instruction Sheet.

Example 2: Connection with D40A

Highest achievable PL/category	Model	Stop category	Reset
PLd/3 equivalent	Emergency Stop Switch A165E/A22E Non-contact Door Switch D40A Flexible Safety Unit G9SX-BC202-□ Non-contact Door Switch Controller G9SX-NS202-□	0	Emergency Stop Switch: Manual Non-contact Door Switch: Auto

Note: The PL evaluation result on this connection example applies to safety functions related to the D40A Non-Contact Door Switch. The above PL is only the evaluation result of the example. The PL must be evaluated in an actual application by the customer after confirming the usage conditions.

● Application Overview

- The power supply to the motor M1 and M2 is turned OFF immediately when the emergency stop switch S1 is pressed.
- The power supply to the Motor M1 is kept OFF until the reset switch S2 is pressed while the emergency stop switch S1 is released.
- The power supply to the motor M2 is turned OFF immediately when the S3 detects that the guard is opened.
- The power supply to the motor M2 is kept OFF until the reset switch S1 is pressed while the guard is closed and the emergency stop switch S1 is released.

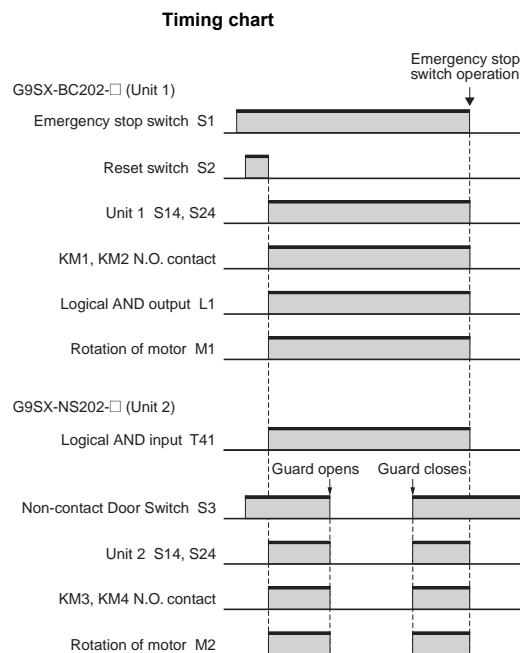
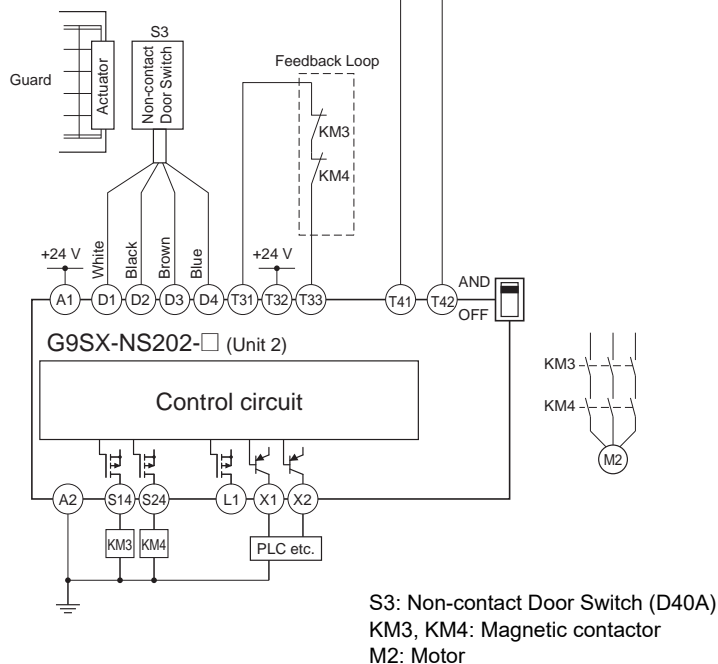
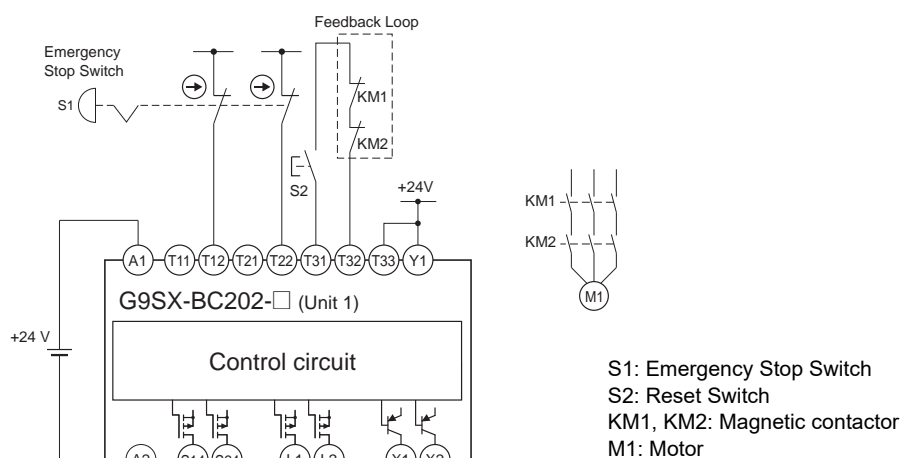

Note: For details on Non-contact Door Switch wiring, refer to page 76 or to the Instruction Sheet.

Example 1: Connection with D40Z

Highest achievable PL/category	Model	Stop category	Reset
PLe/4 equivalent	Emergency Stop Switch A165E/A22E Non-contact Door Switch D40Z Non-contact Door Switch Controller G9SX-NSA222-T03-□	0	Manual

Note: The above PL is only the evaluation result of the example. The PL must be evaluated in an actual application by the customer after confirming the usage conditions.

● Application Overview

- The power supply to the motor M1 is turned OFF immediately when the emergency stop switch S1 is pressed.
- The power supply to the motor M1 is turned OFF immediately when the S2 detects that the guard is opened.
- The power supply to the motor M1 is kept OFF until the reset switch S3 is pressed while the guard is closed and the emergency stop switch S1 is released.

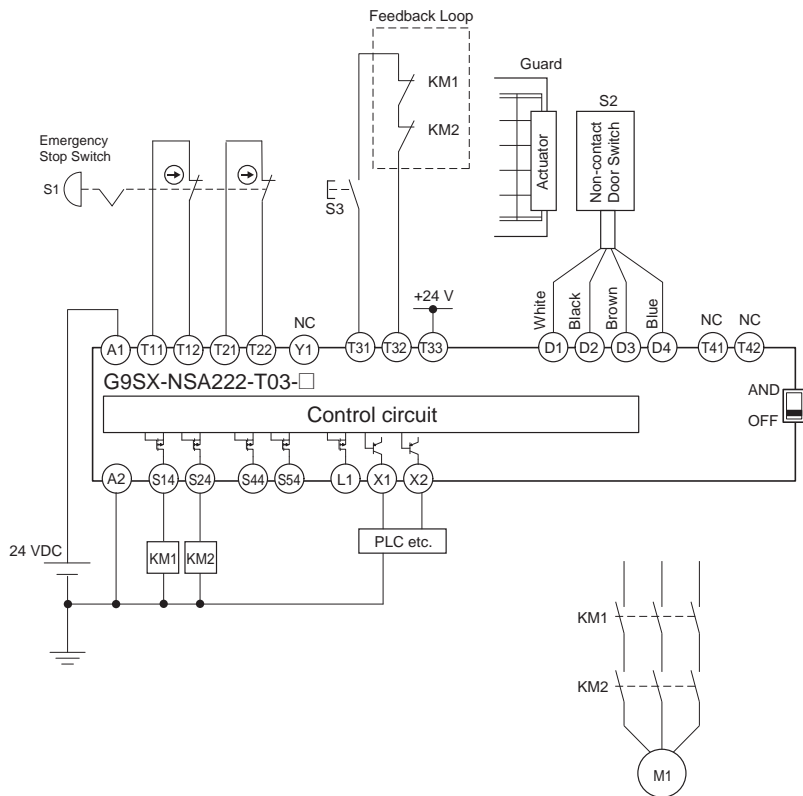

- S1: Emergency Stop Switch
 S2: Non-contact Door Switch (D40Z)
 S3: Reset Switch
 KM1, KM2: Magnetic contactor
 M1: Motor

Timing chart

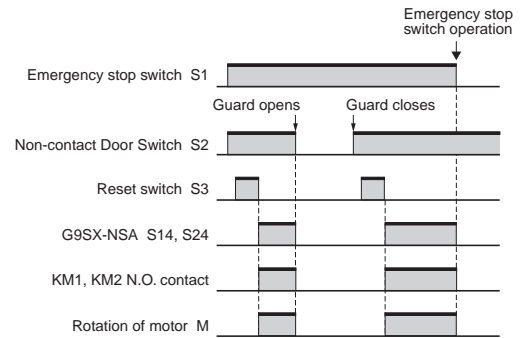

Note: For details on Non-contact Door Switch wiring, refer to page 76 or to the Instruction Sheet.

Example 2: Connection with D40Z

Highest achievable PL/category	Model	Stop category	Reset
PLe/4 equivalent	Emergency Stop Switch A165E/A22E Non-contact Door Switch D40Z Flexible Safety Unit G9SX-BC202-□ Non-contact Door Switch Controller G9SX-NS202-□	0	Emergency Stop Switch: Manual Non-contact Door Switch: Auto

Note: The above PL is only the evaluation result of the example. The PL must be evaluated in an actual application by the customer after confirming the usage conditions.

● Application Overview

- The power supply to the motor M1 and M2 is turned OFF immediately when the emergency stop switch S1 is pressed.
- The power supply to the Motor M1 is kept OFF until the reset switch S2 is pressed while the emergency stop switch S1 is released.
- The power supply to the motor M2 is turned OFF immediately when the S3 detects that the guard is opened.
- The power supply to the motor M2 is kept OFF until the reset switch S1 is pressed while the guard is closed and the emergency stop switch S1 is released.

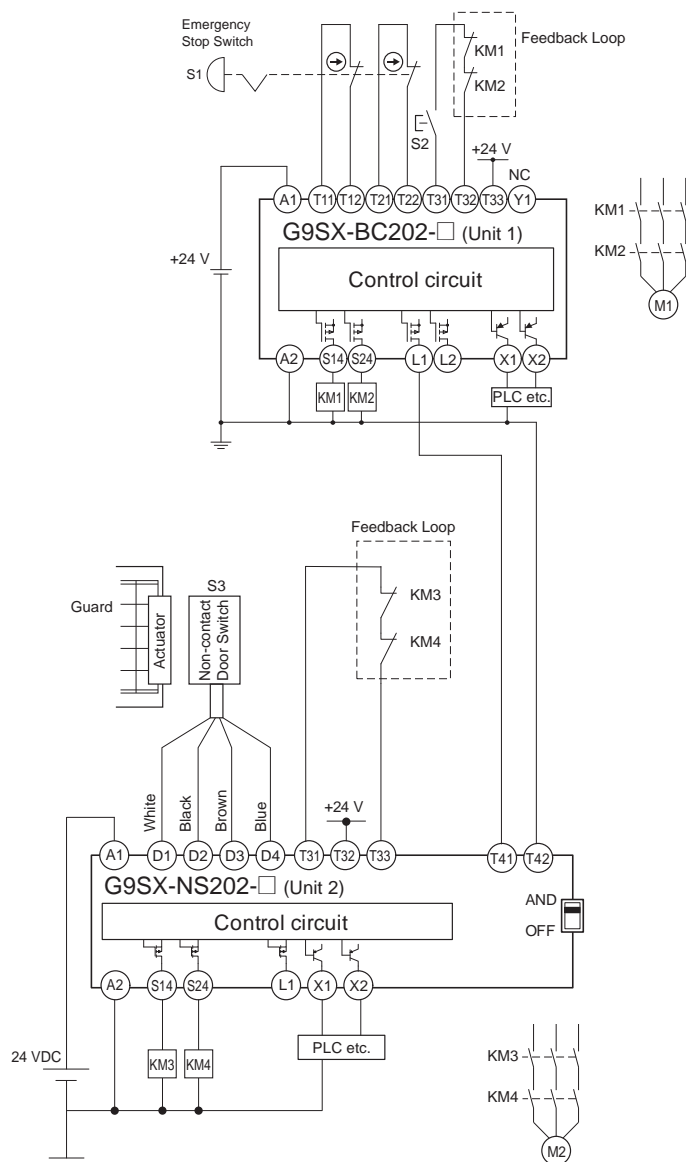

S1: Emergency Stop Switch
S2: Reset Switch
KM1, KM2: Magnetic contactor
M1: Motor

S3: Non-contact Door Switch (D40Z)
KM3, KM4: Magnetic contactor
M2: Motor

Timing chart

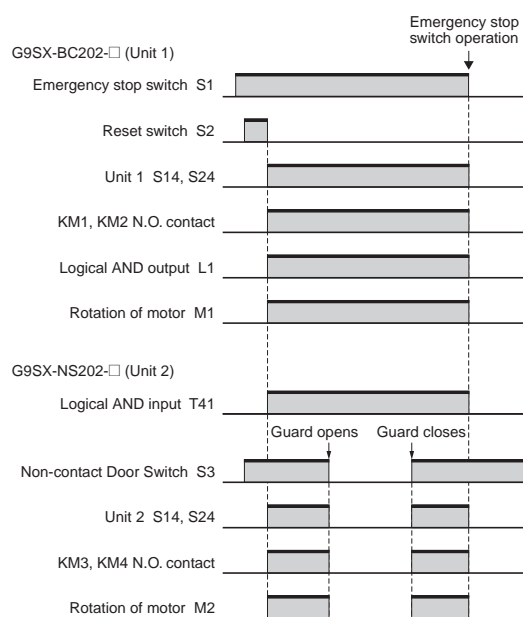

Note: For details on Non-contact Door Switch wiring, refer to page 76 or to the Instruction Sheet.





Safety Precautions

Be sure to read the *Common Precautions for Safety Warning* at the following URL: <http://www.ia.omron.com/>.

Indication and Meaning for Safe Use

 WARNING	Indicates a potentially hazardous situation which, if not avoided, will result in minor or moderate injury, or may result in serious injury or death. Additionally there may be significant property damage.
Precautions for Safe Use	Supplementary comments on what to do or avoid doing, to use the product safely.
Precautions for Correct Use	Supplementary comments on what to do or avoid doing, to prevent failure to operate, or undesirable effect on product performance.

WARNING

- Serious injury may possibly occur due to breakdown of safety outputs.
Do not connect loads beyond the rated value to the safety outputs. 
- Serious injury may possibly occur due to loss of required safety functions.
Wire the D40A and G9SX-NS properly so that supply voltages or voltages for loads do NOT touch the safety outputs accidentally. 
- Serious injury may possibly occur due to damage to safety outputs.
Provide protective circuits against counter-electromotive force if inductive loads are connected to safety outputs. 
- Serious injury may possibly occur due to loss of safety functions.
Use appropriate devices referring to the information provided below. 

Control device	Requirements
Emergency stop switch	Use approved device with direct opening mechanism complying with IEC/EN 60947-5-1.
Safety door switch, Safety limit switch	Use approved device with direct opening mechanism complying with IEC/EN 60947-5-1 and capable of switching micro loads of 24 VDC, 5 mA.
Non-contact Door Switch	The G9SX-NS must be used with D40A-2/D40A Non-contact Door Switches.
Relay with forcibly guided contacts	Use approved devices with forcibly guided contacts complying with IEC 61810-3 (EN 50205). For feedback, use devices with contacts capable of switching micro loads of 24 VDC, 5 mA.
Contactor	Use approved devices complying with IEC/EN 60947-4-1 for auxiliary contact linked with power contact (mirror contact). For feedback, use devices with contacts capable of switching micro loads of 24 VDC, 5 mA.
Other devices	Evaluate whether devices used are appropriate to satisfy the requirements of the safety category level.

Precautions for Safe Use

1. Disconnect G9SX-NS□ from power supply when wiring. Devices connected to G9SX-NS□ may operate unexpectedly.
 1. Turn OFF the load power supply before wiring. Failure to do so may cause electric shock.
 2. Devices connected to the product may operate unexpectedly.
2. Do not operate the product in atmospheres containing flammable or explosive gas. Arcs or heating of relays during switching may cause fire or explosion.
3. Wire conductors correctly and verify the operation of the product before using the system in which the product is incorporated. Incorrect wiring may lead to loss of safety functions.
4. Do not dismantle, repair, or modify the product. Doing so may lead to loss of safety functions.
5. Use the G9SX within an enclosure with a IP54 degree of protection or higher according to IEC/EN 60529.
6. Do not apply DC voltages exceeding the rated voltages, nor any AC voltages to G9SX-NS□. Do not connect to DC distribution network.
7. Use a DC supply satisfying the requirements given below to prevent electric shock.
 - A DC power supply with double or reinforced insulation, for example, according to IEC/EN 60950 or EN 50178, or a transformer according to IEC/EN 61558.
 - A DC supply satisfying the requirements for class 2 circuits or limited voltage/current circuits stated in UL 508.
8. Properly apply the specified voltages to the inputs. Applying inappropriate voltages may cause the product to fail to perform its specified function, which could lead to the loss of safety functions or damages to the product.
9. Auxiliary error outputs and auxiliary monitoring outputs are NOT safety outputs. Do not use these outputs as safety outputs. Such incorrect use will cause loss of safety functions of the G9SX and its relevant system. Also logical AND connection outputs can only be used for logical AND connections with the G9SX-□.
10. After installing the G9SX-NS□, qualified personnel must confirm the installation, and must conduct test operations and maintenance. The qualified personnel must be qualified and authorized to secure safety at each phases of design, installation, running, maintenance, and disposal of system.
11. A qualified person in charge, who is familiar with the machine in which G9SX-NS□ is to be installed, must conduct and verify the installation.
12. Perform daily and 6-month inspections for the G9SX-NS□. Otherwise, the system may fail to work properly, resulting in serious injury.
13. Connect to the G9SX-NS□ only appropriate components or devices complying with relevant safety standards corresponding to the required level of safety category. Conformity to requirements of safety category must be determined as an entire system. It is recommended to consult an authorized certification body regarding assessment of conformity to the required safety level.
14. OMRON is not responsible for conformity with any safety standards covering the customer's entire system.
15. Be careful not to have your fingers caught when mounting terminal blocks.
16. The service life will depend on the switching conditions. Be sure to check the actual operating conditions using the actual devices, and make sure that the number of switching operations will not cause performance problems.

Precautions for Correct Use

- Handle with Care.
Do not drop the product or expose it to excessive vibration or mechanical shock. The product may be damaged and may not function properly.
- Storage and Operating Conditions
Do not store or use the products under the following conditions.
 - In direct sunlight
 - At ambient temperatures not between -10 and 55°C
 - At relative humidity not between 25% and 85% or under temperature changes that could causes condensation
 - In corrosive or combustible gases
 - Where subject to vibration or mechanical shock beyond the rated values
 - Where subject to contact with water, oil, or chemicals
 - In an atmosphere containing excessive dust, saline, or metal powder
 - Where iron filings or powder may fall on the product
- D40A is a class A product. In residential areas D40A may cause radio interference, in which case the user may be required to take adequate measures to reduce interference.
- Mounting
Mount the G9SX-NS to a DIN rail using End Plates (PFP-M, not included with the product) so that the G9SX-NS does not fall off of the rails due to vibration or other causes, especially when the length of DIN railing is short compared to the width of the G9SX-NS.
 - At least 25 mm between side surfaces of the G9SX-NS
 - At least 50 mm above the top surface of the G9SX-NS and below the bottom surface of the G9SX-NS.

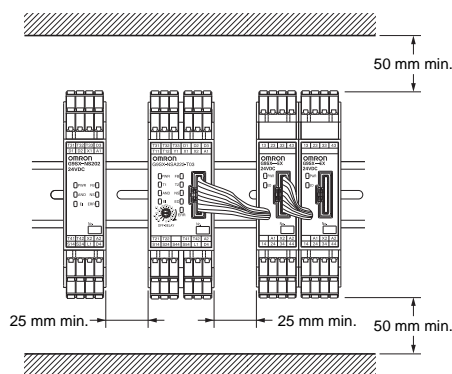

- Wiring
 - G9SX-NS-RT (with Screw Terminals)
 - Use the following to wire the G9SX-NS-RT.

Solid wire (steel wire)	0.2 to 2.5 mm ² (AWG24 to AWG12)
Stranded wire (flexible wire)	0.2 to 2.5 mm ² (AWG24 to AWG12)

 - Tighten each screw to the specified torque of 0.5 to 0.6 N·m, or the G9SX-NS may malfunction or generate heat.
 - Strip the wire for no longer than 7 mm.
 - G9SX-NS-RC (with Spring-cage Terminals)
 - Use the following to wire the G9SX-NS-RC.

Solid wire (steel wire)	0.2 to 2.5 mm ² (AWG24 to AWG12)
Stranded wire (flexible wire)	0.2 to 2.5 mm ² (AWG24 to AWG12)

 - Strip the wire for no longer than 7 mm.
 - Logical AND Connections
 - Use VCTF cables or shielded cables for logical AND connections between Units.

- Connecting G9SX-EX- Expansion Units
 - Remove the terminating connector from the connector on the G9SX-NSA222-T03. Insert the connector on the connecting cable of Expansion Unit into the connector on the G9SX-NSA222-T03.
 - Connect the terminating connector to the connector on the Expansion Unit at the end position.
When the G9SX-NSA222-T03 is used without Expansion Units, leave the terminating connector on the G9SX-NSA222-T03.
 - Do not remove the terminating connector or connecting cables of Expansion Units while the system is operating.
 - Before applying the supply voltage, confirm that the connectors are locked firmly.
 - All of the Expansion Units must be supplied with its specified voltages within 10 s after the connected G9SX-NSA222-T03 is supplied with voltage.
Otherwise, the G9SX-NSA222-T03 will detect a power supply error for the Expansion Units.
- Use cables with a length of less than 100 m total to connect the safety inputs, feedback/reset inputs, and logical AND connection inputs and outputs.
- Set the time duration of OFF-delay to an appropriate value that does not cause the loss of safety functions of system.
- Logical AND connections between Units (Refer to *Functions* on page 80.)
 - To use logical AND connection inputs, enable the logical AND connection input for the G9SX-NS that will receive the inputs.
 - Connect the logical AND connection inputs appropriately to the logical AND connection outputs of the G9SX.
 - When configuring the safety system, be sure to consider that the delay of response time caused by logical AND connection does not degrade the safety functions of the system. (Refer to *Response Time and Operating Time* on page 73.)
- To determine safety distance to hazards, take into account the delay of safety outputs caused by the following time:
 - Response time of safety inputs
 - Response time of D40A-2/D40A Non-contact Door Switch inputs
 - Response time of logical AND connection input (Refer to *Response Time and Operating Time* on page 73.)
 - Preset OFF-delay time
 - Accuracy of OFF-delay time
- Start the rest of the system after 5 s or longer has passed since applying supply voltage to all G9SX in the system.
- Be sure to ground the A2 terminal of the power supply to help prevent malfunctions caused by noise. Also, connect a surge absorber to each end of the coil on inductive loads to reduce noise generation. When sharing a power supply with a Light Curtain, use a DC power supply that will not fail for a momentary power interruption of 20 ms or less.
- Devices connected to the G9SX-NS may operate unexpectedly. When replacing the G9SX-NS, disconnect it from power supply.
- Adhesion of solvent
Do not allow organic solvents, such as alcohol, thinner, trichloroethane, or gasoline, to come into contact with the product. Such solvents make the markings on G9SX-NS illegible and cause deterioration of parts.
- Do not mix AC and DC circuits for contact outputs in a single G9SX-EX- Units and use them respectively as dedicated DC-circuit and AC-circuit contact outputs.

17. Safety Application Controller's Relay durability depends greatly on the switching condition. Confirm the actual conditions of operation in which the Relay will be used in order to make sure the permissible number of switching operations.
When the accumulated number of operation exceeds its permissible range, it can cause failure of reset of safety control circuit. In such case, please replace the Relay or the Safety Application Controller immediately.
If the Relay or the Safety Application Controller is used continuously without replacing, then it can lead to loss of safety function.
18. Operate the reset input more than 0.4 seconds immediately after the safety outputs are OFF.
G9SX does not accept the reset input from when the outputs are turned ON and until 0.4 seconds passes after the outputs are turned OFF.

Safety Categories (EN ISO13849-1)

You can use the D40A-2 and D40Z with the G9SX-NS□ for applications in PLe and Safety Category 4 environments defined in the EN ISO13849-1 European standard and the ISO 13849-1 international standard.

You can use the D40A with the G9SX-NS□ for applications in PLd and Safety Category 3 environments defined in the EN ISO13849-1 European standard and the ISO 13849-1 international standard. Compliance was determined using circuit examples specified by OMRON and may not be applicable to all conditions. Safety categories are determined for the overall safety control system. Confirm compliance sufficiently with your application.

Requirements for Safety Category 3 or 4 (EN ISO 13849-1)

1. Connect external input D1-D2 and external output D3-D4 to D40A-2/D40Z (Category 4)/D40A (Category 3) Switches.
2. Input two channels for external inputs T11-T12 and T21-T22.
3. Input external inputs T11-T12 and T21-T22 from switches with direct opening mechanisms. For limit switches, make sure at least one of the switches has a direct opening mechanism.
4. Input the NC signal from the contactor to T31-T32 for a manual reset and to T31-T33 for an auto reset. (Refer to *Application Examples* on page 85)
5. Make sure to connect the A2 terminal to ground.

Standards Certification

Directives

- EMC Directive
- Machinery Directive

Standards/UL Certification

- EN ISO 13849-1 PLe/Safety Category 4 (Used with D40A-2 and D40Z)
- EN ISO 13849-1 PLd/Safety Category 3 (Used with D40A)
- IEC/EN 61508 SIL3
- IEC/EN 61000-6-2
- IEC/EN 61000-6-4
- UL508
- UL1998
- CAN/CSA C22.2 No.142

Terms and Conditions Agreement

Read and understand this catalog.

Please read and understand this catalog before purchasing the products. Please consult your OMRON representative if you have any questions or comments.

Warranties.

(a) Exclusive Warranty. Omron's exclusive warranty is that the Products will be free from defects in materials and workmanship for a period of twelve months from the date of sale by Omron (or such other period expressed in writing by Omron). Omron disclaims all other warranties, express or implied.

(b) Limitations. OMRON MAKES NO WARRANTY OR REPRESENTATION, EXPRESS OR IMPLIED, ABOUT NON-INFRINGEMENT, MERCHANTABILITY OR FITNESS FOR A PARTICULAR PURPOSE OF THE PRODUCTS. BUYER ACKNOWLEDGES THAT IT ALONE HAS DETERMINED THAT THE PRODUCTS WILL SUITABLY MEET THE REQUIREMENTS OF THEIR INTENDED USE.

Omron further disclaims all warranties and responsibility of any type for claims or expenses based on infringement by the Products or otherwise of any intellectual property right. (c) Buyer Remedy. Omron's sole obligation hereunder shall be, at Omron's election, to (i) replace (in the form originally shipped with Buyer responsible for labor charges for removal or replacement thereof) the non-complying Product, (ii) repair the non-complying Product, or (iii) repay or credit Buyer an amount equal to the purchase price of the non-complying Product; provided that in no event shall Omron be responsible for warranty, repair, indemnity or any other claims or expenses regarding the Products unless Omron's analysis confirms that the Products were properly handled, stored, installed and maintained and not subject to contamination, abuse, misuse or inappropriate modification. Return of any Products by Buyer must be approved in writing by Omron before shipment. Omron Companies shall not be liable for the suitability or unsuitability or the results from the use of Products in combination with any electrical or electronic components, circuits, system assemblies or any other materials or substances or environments. Any advice, recommendations or information given orally or in writing, are not to be construed as an amendment or addition to the above warranty.

See <http://www.omron.com/global/> or contact your Omron representative for published information.

Limitation on Liability; Etc.

OMRON COMPANIES SHALL NOT BE LIABLE FOR SPECIAL, INDIRECT, INCIDENTAL, OR CONSEQUENTIAL DAMAGES, LOSS OF PROFITS OR PRODUCTION OR COMMERCIAL LOSS IN ANY WAY CONNECTED WITH THE PRODUCTS, WHETHER SUCH CLAIM IS BASED IN CONTRACT, WARRANTY, NEGLIGENCE OR STRICT LIABILITY.

Further, in no event shall liability of Omron Companies exceed the individual price of the Product on which liability is asserted.

Suitability of Use.

Omron Companies shall not be responsible for conformity with any standards, codes or regulations which apply to the combination of the Product in the Buyer's application or use of the Product. At Buyer's request, Omron will provide applicable third party certification documents identifying ratings and limitations of use which apply to the Product. This information by itself is not sufficient for a complete determination of the suitability of the Product in combination with the end product, machine, system, or other application or use. Buyer shall be solely responsible for determining appropriateness of the particular Product with respect to Buyer's application, product or system. Buyer shall take application responsibility in all cases.

NEVER USE THE PRODUCT FOR AN APPLICATION INVOLVING SERIOUS RISK TO LIFE OR PROPERTY OR IN LARGE QUANTITIES WITHOUT ENSURING THAT THE SYSTEM AS A WHOLE HAS BEEN DESIGNED TO ADDRESS THE RISKS, AND THAT THE OMRON PRODUCT(S) IS PROPERLY RATED AND INSTALLED FOR THE INTENDED USE WITHIN THE OVERALL EQUIPMENT OR SYSTEM.

Programmable Products.

Omron Companies shall not be responsible for the user's programming of a programmable Product, or any consequence thereof.

Performance Data.

Data presented in Omron Company websites, catalogs and other materials is provided as a guide for the user in determining suitability and does not constitute a warranty. It may represent the result of Omron's test conditions, and the user must correlate it to actual application requirements. Actual performance is subject to the Omron's Warranty and Limitations of Liability.

Change in Specifications.

Product specifications and accessories may be changed at any time based on improvements and other reasons. It is our practice to change part numbers when published ratings or features are changed, or when significant construction changes are made. However, some specifications of the Product may be changed without any notice. When in doubt, special part numbers may be assigned to fix or establish key specifications for your application. Please consult with your Omron's representative at any time to confirm actual specifications of purchased Product.

Errors and Omissions.

Information presented by Omron Companies has been checked and is believed to be accurate; however, no responsibility is assumed for clerical, typographical or proofreading errors or omissions.

Note: Do not use this document to operate the Unit.

OMRON Corporation Industrial Automation Company

Kyoto, JAPAN

Contact : www.ia.omron.com

Regional Headquarters

OMRON EUROPE B.V.

Wegalaan 67-69, 2132 JD Hoofddorp
The Netherlands
Tel: (31) 2356-81-300 Fax: (31) 2356-81-388

OMRON ELECTRONICS LLC

2895 Greenspoint Parkway, Suite 200
Hoffman Estates, IL 60169 U.S.A.
Tel: (1) 847-843-7900 Fax: (1) 847-843-7787

OMRON ASIA PACIFIC PTE. LTD.

438B Alexandra Road, #08-01/02 Alexandra
Technopark, Singapore 119968
Tel: (65) 6835-3011 Fax: (65) 6835-3011

OMRON (CHINA) CO., LTD.

Room 2211, Bank of China Tower,
200 Yin Cheng Zhong Road,
PuDong New Area, Shanghai, 200120, China
Tel: (86) 21-6023-0333 Fax: (86) 21-5037-2388

Authorized Distributor:

©OMRON Corporation 2022-2024 All Rights Reserved.
In the interest of product improvement,
specifications are subject to change without notice.

CSM_1_5

Cat. No. F120-E1-05 1224 (0322)