

## Power MOS FET Relays with the Same Shape as the G2R for Both AC and DC, Capable of 1 A Load Switching

- Reduces wiring work by 60% when combined with the P2RF-05-PU Push-In Plus Socket (according to actual OMRON measurements).
- Capable of switching 1-A load at 240 VAC or 100 VDC.
- Maximum leakage current of 10  $\mu$ A for OFF output.
- Withstand voltage 2,500 VAC between inputs and outputs.
- Built-in input resistance and overvoltage absorption circuit.
- Capable of AC full-wave rectification and half-wave rectification load operation.

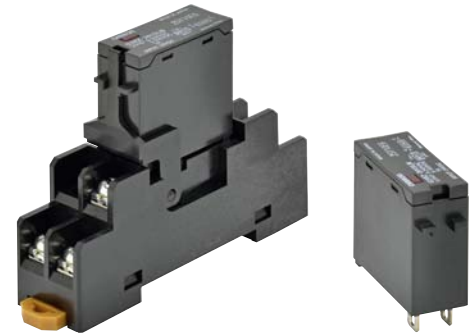

**Note:** The socket is optional.

RoHS Compliant



Refer to Safety Precautions for All Solid State Relays.

## Model Number Legend

**G3RZ** -   
 1 2 3 4 5

### 1. Load voltage

2: Load voltage: 240 VAC, 100 VDC

### 2. Load Current

01: Load current: 1 A

### 3. Terminal Shape

S: Plug-in terminals

### 4. Zero cross function

L: No zero cross function

### 5. Operation Indicator

N: With operation indicator



## Ordering Information

### List of Models

| Insulation method    | Zero cross function | Operation Indicator | Applied output load                        | Input rated voltage | Model                   |
|----------------------|---------------------|---------------------|--|---------------------|-------------------------|
| Photovoltaic coupler | No                  | Yes                 | 1.0 A,<br>5 to 240 VAC,<br>or 5 to 100 VDC | 5 VDC               | <b>G3RZ-201SLN DC5</b>  |
|                      |                     |                     |  | 12 VDC              | <b>G3RZ-201SLN DC12</b> |
|                      |                     |                     |  | 24 VDC              | <b>G3RZ-201SLN DC24</b> |

## Accessories (Order Separately)

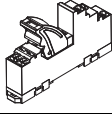
### Connection Sockets

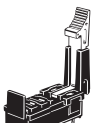
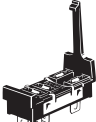
| Classification | Terminal type                                    | Appearance  | Model      |
|----------------|--|---|------------|
| Front-mounting | Screw terminals                                  |    | P2RFZ-05   |
|                | Screw terminals<br>(finger protection structure) |    | P2RFZ-05-E |
|                | Push-In Plus terminal blocks                     |    | P2RF-05-PU |
| Back-mounting  | Relays with PCB Terminals                        |    | P2R-05P    |
|                |  |   | P2R-057P   |
|                | Solder terminals                                 |  | P2R-05A    |

**For Push-In Plus Terminal Block Sockets**  
**Short Bars**

| Applicable sockets | Pitch   | Application                         | Shape/external dimensions | Number of poles | L (Length) | Insulation color                  | Short Bars Model*1 |
|--------------------|---------|-------------------------------------|---------------------------|-----------------|------------|-----------------------------------|--------------------|
| P2RF-05-PU         | 7.75 mm | Bridging contact terminals (common) |                           | 2               | 15.1       | Red (R)<br>Blue (S)<br>Yellow (Y) | PYDN-7.75-020□     |
|                    |         |                                     |                           | 3               | 22.85      |                                   | PYDN-7.75-030□     |
|                    |         |                                     |                           | 4               | 30.6       |                                   | PYDN-7.75-040□     |
|                    |         |                                     |                           | 20              | 154.6      |                                   | PYDN-7.75-200□     |
|                    | 15.5 mm | For Coil terminals                  |                           | 8               | 115.55     |                                   | PYDN-15.5-080□     |

\*1. Replace the box (□) in the model number with the code for the covering color. □Color selection: R = Red, S = Blue, Y = Yellow

**Labels**

| Applicable sockets | Model                               |
|--------------------|-------------------------------------|
| P2RF-05-PU         | XW5Z-P4.0LB1<br>(1 sheet/60 pieces) |

**For Screw Terminal Sockets**  
**Short Bars**

| Applicable sockets | Pitch   | Appearance | Dimensions (mm) | Number of poles | Insulation color | Short Bars Model | Maximum carry current | Minimum order (set) |
|--------------------|---------|------------|-----------------|-----------------|------------------|------------------|-----------------------|---------------------|
| P2RFZ-05-E         | 15.7 mm |            |                 | 10              | Blue(S)          | P2DN-15.7-100S   | 20 A                  | 1                   |
| P2RFZ-05           | 19.4 mm |            |                 | 10              | Blue(S)          | P2DN-19.4-100S   | 20 A                  | 1                   |

- Note:**
- Select an applicable type of short bars by checking applicable socket type, appearance, and dimensions.
  - Use the Short Bars for crossover wiring within one Socket or between Sockets.
  - Use the short bars on the lower section of the socket.  
 When using the short bars on the upper section of the socket, insert them so that their heads are pointed upwards (see the figure below). Otherwise, short bars may interfere with the socket, leading to improper wiring and contact failure.

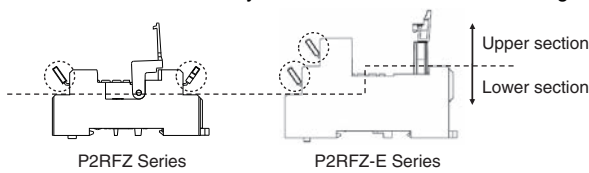

\* One set (order unit) contains 10 short bars and 20 caps.

**Accessories for Short Bars (P2DN)**  
**Cap**

| Short Bars Models                | Appearance | Dimensions (mm) | Model      |
|----------------------------------|------------|-----------------|------------|
| P2DN-19.4-100S<br>P2DN-15.7-100S |            |                 | P2DN-CP100 |

## For Screw Terminal Sockets (P2RFZ-05)

### Terminal covers

| Applicable sockets | Appearance  | Model  | Minimum order (set) |
|--------------------|---|--------|---------------------|
| P2RFZ-05           |  | P2CZ-C |                     |

- Note:** 1. Use these covers in a combination with P2RFZ-05.  
 2. Do not install short bars (optional) on the upper section (see the figure below).  
 Short bars may interfere with the terminal cover, making the terminal cover unusable.

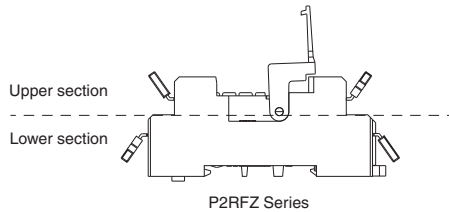

### Dimensions with terminal cover

#### P2RFZ-05

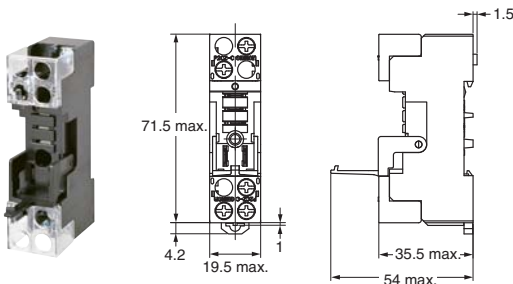



### Labels

| Applicable sockets | Model        | Minimum order (sheet)<br>(quantity per sheet) |
|--------------------|--------------|---|
| P2RFZ-05-E         | XW5Z-P2.5LB1 | 5<br>1 sheet (72 pieces)                      |

**Note:** This label cannot be applied on sockets other than P2RFZ-05-E.

### DIN Track Mounting Parts

| Classification     | Type   | Appearance  | Model     |
|--------------------|--|---|-----------|
| For front-mounting | DIN Tracks                                       | Shallow type, total length: 1 m   | PFP-100N  |
|                    |  | Shallow type, total length: 0.5 m   | PFP-50N   |
|                    |  | Deep type, total length: 1 m  | PFP-100N2 |
|                    | End Plate  |  | PFP-M     |
|                    | Spacer   |  | PFP-S     |
| For back-mounting  | Mounting Plates for Sockets *<br>(For 5 Sockets) |  | P2R-P     |

\* Used to mount several P2R-05A Connecting Sockets side by side.

# Ratings and Specifications

## Ratings

| Item<br>Model | Input         |                   |             |                      | Output               |                              |                              |                 |                         |
|---------------|---------------|-------------------|-------------|----------------------|----------------------|------------------------------|------------------------------|-----------------|-------------------------|
|               | Rated voltage | Operating voltage | Impedance   | Voltage level        |                      | Rated load voltage           | Load voltage range           | Load current*   | Surge withstand current |
|               |               |                   |             | Must-operate voltage | Must-release voltage |                              |                              |                 |                         |
| G3RZ-201SLN   | 5 VDC         | 4 to 6 VDC        | 400 Ω ±20%  | 4 VDC max.           | 1 VDC min.           | 5 to 240 VAC<br>5 to 100 VDC | 3 to 264 VAC<br>3 to 125 VDC | 100 μA to 1.0 A | 10 A (10 ms)            |
|               | 12 VDC        | 9.6 to 14.4 VDC   | 1.1 kΩ ±20% | 9.6 VDC max.         |                      |                              |                              |                 |                         |
|               | 24 VDC        | 19.2 to 28.8 VDC  | 2.2 kΩ ±20% | 19.2 VDC max.        |                      |                              |                              |                 |                         |

\* Depends on the ambient temperature. Refer to the reference data *Load Current vs. Ambient Temperature Rating* on page 5 for details.

## Characteristics

|                               |  |
|-------------------------------|--|
| Operation time                | 6 ms max.  |
| Release time                  | 10 ms max.   |
| Output ON resistance          | 2.4 Ω max.   |
| OFF leakage current           | 10 μA max. (at 125 VDC)<br>100 μA max. (at 200 VAC)                      |
| Insulation resistance         | 100 MΩ min. (at 500 VDC)   |
| Dielectric strength           | 2,500 VAC at 50/60 Hz for 1 min. between inputs and outputs              |
| Vibration resistance          | 10 to 55 to 10 Hz, 0.75-mm single amplitude<br>(1.5-mm double amplitude) |
| Shock resistance              | 1,000 m/s <sup>2</sup>   |
| Storage temperature           | -30 to 100°C (with no icing or condensation)                             |
| Ambient operating temperature | -30 to 85°C (with no icing or condensation)                              |
| Ambient operating humidity    | 45% to 85% RH  |
| Weight                        | Approx. 20 g   |
| MTTFd (Reference value)       | 1,000 years min.   |

## Engineering Data

### Load Current vs. Ambient Temperature Rating

#### G3RZ-201SLN

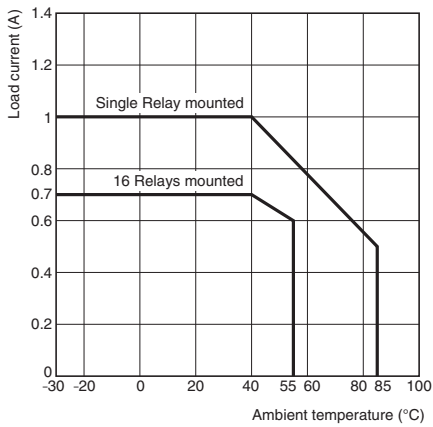

### Surge withstand current

Non-repetitive (If repetitive, keep the inrush current below the dotted line.)

#### G3RZ-201SLN

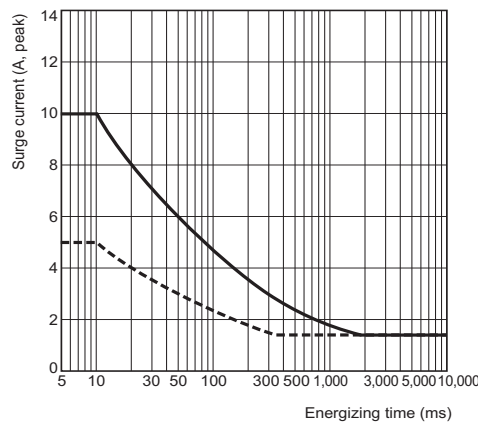

## Dimensions

### Relay

#### G3RZ-201SLN

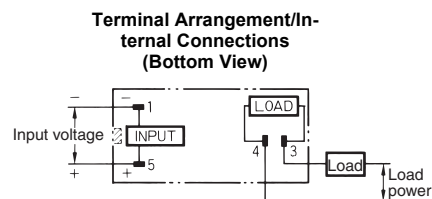
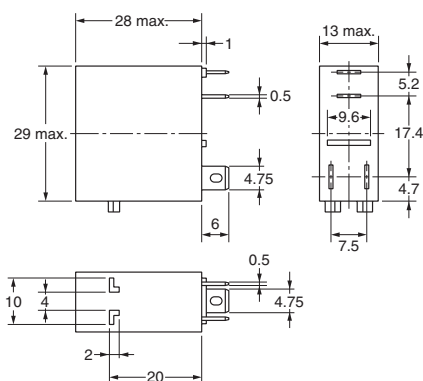
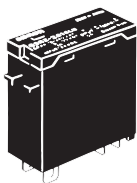

## Accessories (Order Separately)

### Socket Characteristics

| Model        | Rated carry current | Dielectric strength   | Insulation resistance * | Remarks |
|--------------|---------------------|---|-------------------------|---------|
| P2RF-05-PU   | 10 A                | Between contact terminals of same polarity: 1,000 VAC for 1 min | 1,000 MΩ min.           |         |
|              |                     | Between coil and contact terminals: 4,000 VAC for 1 min         |                         |         |
| P2RFZ-05(-E) | 10 A                | Between contact terminals of same polarity: 1,000 VAC for 1 min | 1,000 MΩ min.           |         |
|              |                     | Between coil and contact terminals: 4,000 VAC for 1 min         |                         |         |
| P2R-05P      | 10 A                | Between contact terminals of same polarity: 1,000 VAC for 1 min | 1,000 MΩ min.           |         |
|              |                     | Between coil and contact terminals: 4,000 VAC for 1 min         |                         |         |
| P2R-057P     | 10 A                | Between contact terminals of same polarity: 1,000 VAC for 1 min | 1,000 MΩ min.           |         |
|              |                     | Between coil and contact terminals: 5,000 VAC for 1 min         |                         |         |
| P2R-05A      | 10 A                | Between contact terminals of same polarity: 1,000 VAC for 1 min | 1,000 MΩ min.           |         |
|              |                     | Between ground terminals: 1,500 VAC for 1 min                   |                         |         |
|              |                     | Between coil and contact terminals: 4,000 VAC for 1 min         |                         |         |

\* The insulation resistance was measured with a 500-VDC insulation resistance meter at the same places as those used for measuring the dielectric strength.

Track/Surface Mounting Sockets

P2RF-05-PU

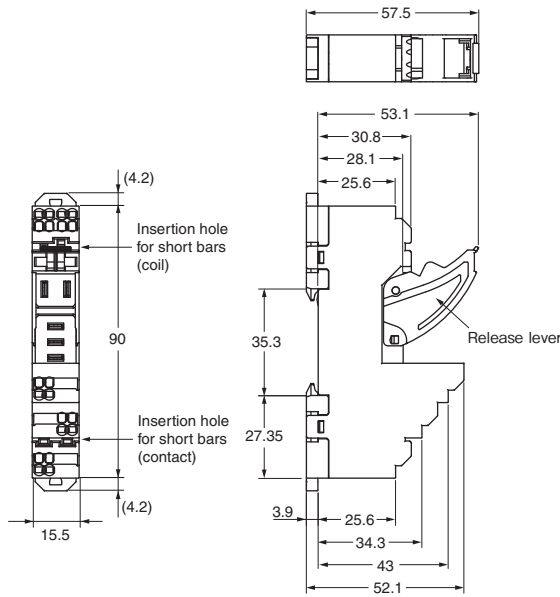

Terminal Arrangement/  
Internal Connection Diagram  
(Top View)

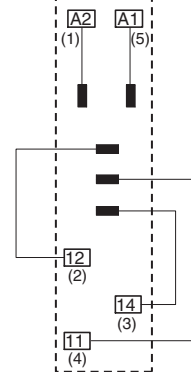

Mounting Hole  
Dimensions

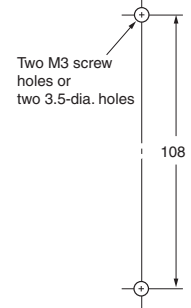

- Note:** 1. The numbers in parentheses are traditionally used terminal numbers.  
2. Insert the short bar into only the A1 or A2 side.

**Note:** Pull out the hooks to mount the Socket with screws.

P2RFZ-05-E

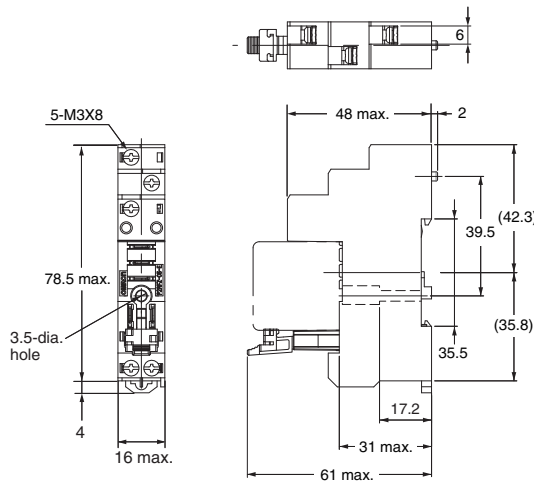

Terminal Arrangement/  
Internal Connection Diagram  
(Top View)

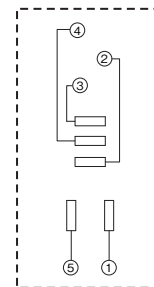

Mounting Hole  
Dimensions

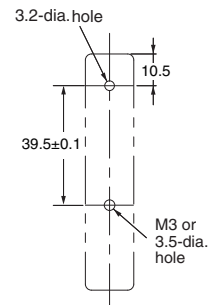

P2RFZ-05

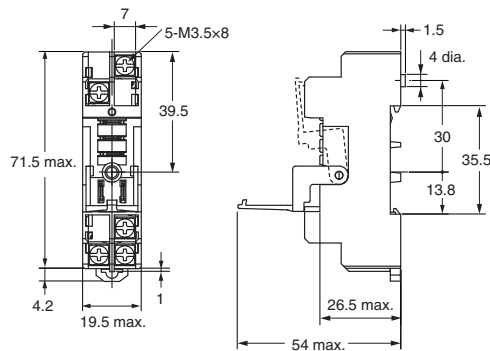

Terminal Arrangement/  
Internal Connection Diagram  
(Top View)

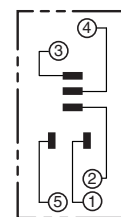

Mounting Hole  
Dimensions

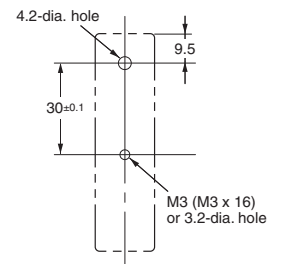

Mounting Height of Relay with Track/Surface Mounting Sockets

P2RF-05-PU

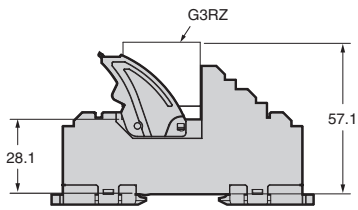

P2RFZ-05

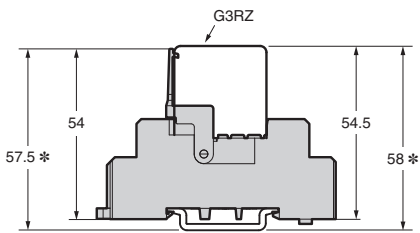

P2RFZ-05-E

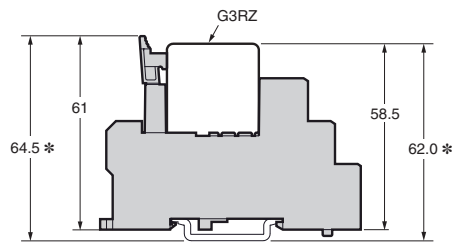

\* These are values when using the DIN track PFP-□N.  
 Heights become higher by approximately 9 mm when using PFP-□N2.



**Back-connecting Sockets**

**P2R-05P (1-pole)**

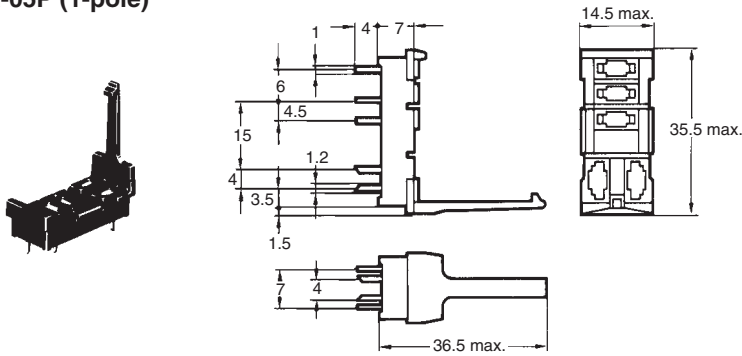

**Terminal Arrangement (Bottom View)**



**Mounting Holes (Bottom View)**

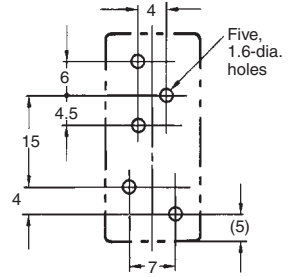

**P2R-057P (1-pole)**

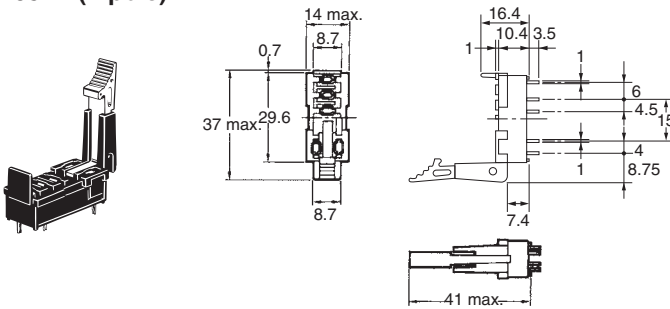

**Terminal Arrangement (Bottom View)**

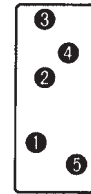

**Mounting Holes (Bottom View)**

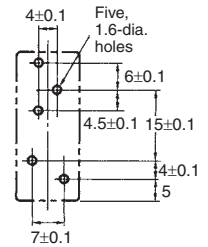

**P2R-05A (1-pole)**

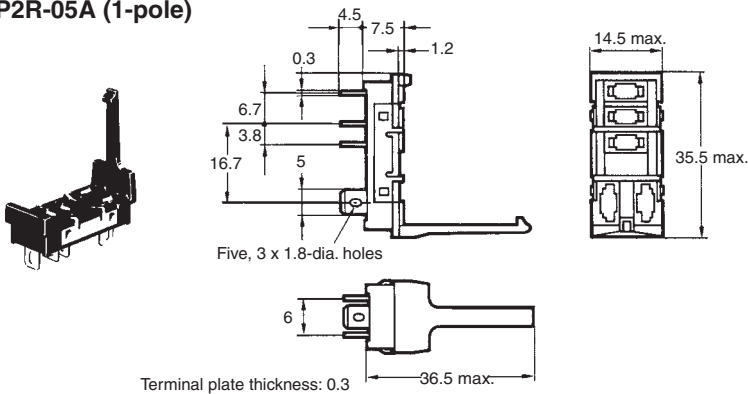

**Terminal Arrangement (Bottom View)**



**Panel Cutout (Bottom View)**

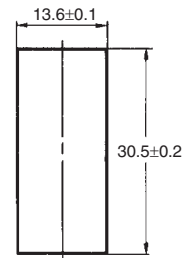

Recommended thickness of the panel is 1.6 to 2.0 mm

**Mounting Height of Relay with Back-connecting Sockets**

**P2R-05P**

**P2R-05-A**

**P2R-057P**

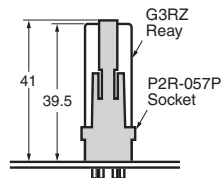
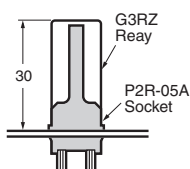
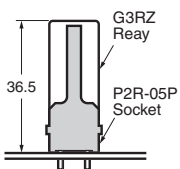

Mounting Tracks

PFP-100N, PFP-50N

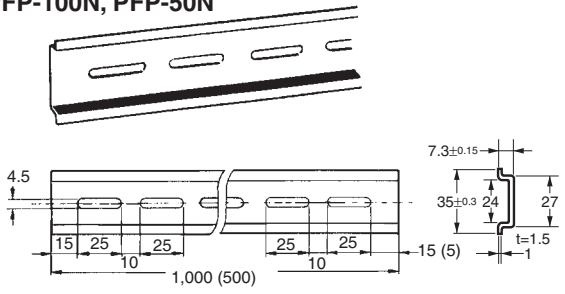

PFP-100N2

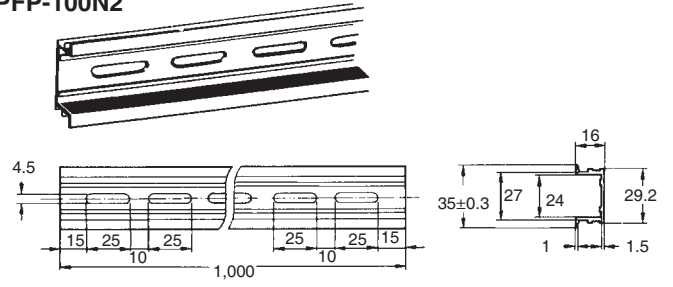

It is recommended to use a panel 1.6 to 2.0 mm thick.

End Plate

PFP-M

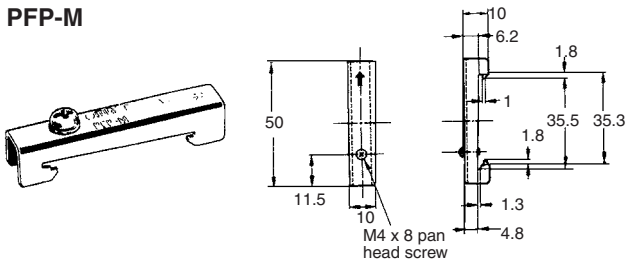

Spacer

PFP-S

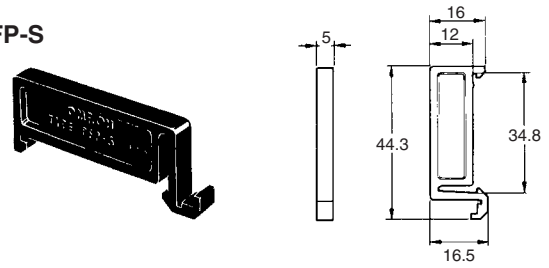

Mounting Plate

P2R-P

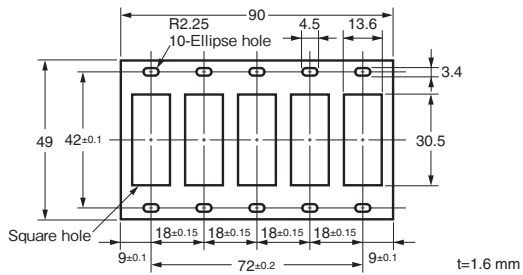

## Safety Precautions

Be sure to read 'the Common Precautions' in the website at the following URL:

<http://www.ia.omron.com/>.

Refer to *Safety Precautions for All Solid State Relays* of your OMRON website.

Refer to *Products Related to Common Sockets and DIN Tracks* for precautions on the applicable Sockets of your OMRON website.

Refer to *PYF-□□-PU/P2RF-□□-PU* for precautions on Push-In Plus Terminal Block Sockets of your OMRON website.

|                                    |  |
|------------------------------------|--|
| <b>Precautions for Correct Use</b> | Supplementary comments on what to do or avoid doing to prevent failure to operate, malfunction, or undesirable effects on product performance. |
|------------------------------------|--|

### Precautions for Correct Use

#### About the Built-in Diodes

The diodes that are built into the Relays are designed to absorb reverse voltage from the Relay's coil. If a large surge in voltage is applied to the diode from an external source, the element will be destroyed.

If there is the possibility of large voltage surges that could be applied to the elements from an external source, take any necessary surge absorption measures.

#### Latching Levers

- Turn OFF the power supply when operating the latching lever. After you use the latching lever always return it to its original state.
- Do not use the latching lever as a switch.
- The latching lever can be used for 100 operations minimum.

#### Relay Replacement

To replace the Relay, turn OFF the power supply to the load and Relay coil sides to prevent unintended operation and possible electrical shock.

#### Coil tape color

Pink tape is used for the AC coil type and blue tape is used for the DC coil type, making it easy to distinguish AC and DC.

#### Using a short-circuit bar

- Use the short-circuit bar that is suitable for the socket you are using and the location of use.
- The short-circuit bar can be cut to match any number of poles. Cut with a tool as appropriate for the number of relays and sockets. When using a cut short-circuit bar, take care to avoid injuring yourself on the cut surface.
- When cutting with a tool, insert the tool from the plastic part and cut along the slot in the plastic part between terminals. If you cut a part other than the slot in the plastic part between terminals, it may not be possible to attach the insulating cap.

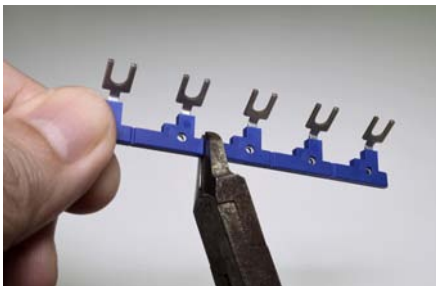

- When using a cut short-circuit bar (P2DN), always use the provided cap to protect the charger part.

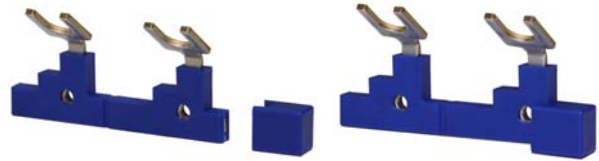

- Use the short-circuit bar to short-circuit two or more output terminals, or two or more input terminals.
- Do not use a deformed short-circuit bar. Risk of failure, malfunctioning, or deterioration of characteristics.
- In socket terminals, insert the short-circuit bar in the correct orientation all the way into all terminals, and then secure with screws.
- Install the short -circuit bar before wiring.

#### Common connection method when using a short bar

When connecting the P2RF-□□-PU input common, insert the short bar into only the A1 or A2 side.

#### Equivalent Labels from Other Companies and Recommended Label Printers

Use the following label printer.

The following table gives the manufacturer's model number as of March 2017.

| Manufacturer  | Omron        | Phoenix Contact  | Weidmuller  | Cembre              |
|---------------|--------------|--|---|---------------------|
| Label         | XW5Z-P4.0LB1 | UCT-TM6  | MF 10/6   | MG-CPM-04<br>41391  |
|               | XW5Z-P2.5LB2 | UCT-TMF5   | ---   | ---                 |
| Label printer | ---          | BLUEMARK<br>CLED,<br>THERMOMA<br>RK CARD<br>SET PLUS,<br>THERMOMA<br>RK CARD | PrintJet<br>ADVANCED,<br>Plotter MCP<br>Plus,<br>Plotter MCP<br>Basic | Markingenius<br>MG3 |

\* When using a printing tool, use a Phoenix Contact label printer.

**Note:** Ask the label manufacturer or printer manufacturer for details.

## Terms and Conditions Agreement

### Read and understand this catalog.

Please read and understand this catalog before purchasing the products. Please consult your OMRON representative if you have any questions or comments.

### Warranties.

(a) Exclusive Warranty. Omron's exclusive warranty is that the Products will be free from defects in materials and workmanship for a period of twelve months from the date of sale by Omron (or such other period expressed in writing by Omron). Omron disclaims all other warranties, express or implied.

(b) Limitations. OMRON MAKES NO WARRANTY OR REPRESENTATION, EXPRESS OR IMPLIED, ABOUT NON-INFRINGEMENT, MERCHANTABILITY OR FITNESS FOR A PARTICULAR PURPOSE OF THE PRODUCTS. BUYER ACKNOWLEDGES THAT IT ALONE HAS DETERMINED THAT THE PRODUCTS WILL SUITABLY MEET THE REQUIREMENTS OF THEIR INTENDED USE.

Omron further disclaims all warranties and responsibility of any type for claims or expenses based on infringement by the Products or otherwise of any intellectual property right. (c) Buyer Remedy. Omron's sole obligation hereunder shall be, at Omron's election, to (i) replace (in the form originally shipped with Buyer responsible for labor charges for removal or replacement thereof) the non-complying Product, (ii) repair the non-complying Product, or (iii) repay or credit Buyer an amount equal to the purchase price of the non-complying Product; provided that in no event shall Omron be responsible for warranty, repair, indemnity or any other claims or expenses regarding the Products unless Omron's analysis confirms that the Products were properly handled, stored, installed and maintained and not subject to contamination, abuse, misuse or inappropriate modification. Return of any Products by Buyer must be approved in writing by Omron before shipment. Omron Companies shall not be liable for the suitability or unsuitability or the results from the use of Products in combination with any electrical or electronic components, circuits, system assemblies or any other materials or substances or environments. Any advice, recommendations or information given orally or in writing, are not to be construed as an amendment or addition to the above warranty.

See <http://www.omron.com/global/> or contact your Omron representative for published information.

### Limitation on Liability: Etc.

OMRON COMPANIES SHALL NOT BE LIABLE FOR SPECIAL, INDIRECT, INCIDENTAL, OR CONSEQUENTIAL DAMAGES, LOSS OF PROFITS OR PRODUCTION OR COMMERCIAL LOSS IN ANY WAY CONNECTED WITH THE PRODUCTS, WHETHER SUCH CLAIM IS BASED IN CONTRACT, WARRANTY, NEGLIGENCE OR STRICT LIABILITY.

Further, in no event shall liability of Omron Companies exceed the individual price of the Product on which liability is asserted.

### Suitability of Use.

Omron Companies shall not be responsible for conformity with any standards, codes or regulations which apply to the combination of the Product in the Buyer's application or use of the Product. At Buyer's request, Omron will provide applicable third party certification documents identifying ratings and limitations of use which apply to the Product. This information by itself is not sufficient for a complete determination of the suitability of the Product in combination with the end product, machine, system, or other application or use. Buyer shall be solely responsible for determining appropriateness of the particular Product with respect to Buyer's application, product or system. Buyer shall take application responsibility in all cases.

NEVER USE THE PRODUCT FOR AN APPLICATION INVOLVING SERIOUS RISK TO LIFE OR PROPERTY OR IN LARGE QUANTITIES WITHOUT ENSURING THAT THE SYSTEM AS A WHOLE HAS BEEN DESIGNED TO ADDRESS THE RISKS, AND THAT THE OMRON PRODUCT(S) IS PROPERLY RATED AND INSTALLED FOR THE INTENDED USE WITHIN THE OVERALL EQUIPMENT OR SYSTEM.

### Programmable Products.

Omron Companies shall not be responsible for the user's programming of a programmable Product, or any consequence thereof.

### Performance Data.

Data presented in Omron Company websites, catalogs and other materials is provided as a guide for the user in determining suitability and does not constitute a warranty. It may represent the result of Omron's test conditions, and the user must correlate it to actual application requirements. Actual performance is subject to the Omron's Warranty and Limitations of Liability.

### Change in Specifications.

Product specifications and accessories may be changed at any time based on improvements and other reasons. It is our practice to change part numbers when published ratings or features are changed, or when significant construction changes are made. However, some specifications of the Product may be changed without any notice. When in doubt, special part numbers may be assigned to fix or establish key specifications for your application. Please consult with your Omron's representative at any time to confirm actual specifications of purchased Product.

### Errors and Omissions.

Information presented by Omron Companies has been checked and is believed to be accurate; however, no responsibility is assumed for clerical, typographical or proofreading errors or omissions.

2024.11

In the interest of product improvement, specifications are subject to change without notice.

**OMRON Corporation**  
Industrial Automation Company

<http://www.ia.omron.com/>

(c)Copyright OMRON Corporation 2024 All Right Reserved.