

SSR with Plug-in Terminals



The Same Shape as the G2R-1-S Power Relays

- Reduces wiring work by 60% when combined with the P2RF-05-PU Push-In Plus Socket (according to actual OMRON measurements).
- These I/O solid state relays can be mounted in OMRON G70A I/O Terminals.
- Lineup includes Input Modules for microloads and Output Modules for standard loads.
- Certified by UL, CSA, and EN (TÜV certification) (-UTU models)



Note: The socket is optional.

Refer to the standards certifications and compliance section of your OMRON website for the latest information on certified models.

RoHS Compliant

Refer to Safety Precautions for All Solid State Relays.

Ordering Information

List of Models

Input Modules for Microloads





Insulation method	Operation indicator	Response speed	Applicable load	Input rated voltage	Model
Photocoupler	Yes	---	4 to 32 VDC 0.1 to 100 mA	100 to 240 VAC	G3R-IAZR1SN-UTU AC100-240
		High-speed		5 VDC	G3R-IDZR1SN-UTU DC5
		Low-speed		12 to 24 VDC	G3R-IDZR1SN-UTU DC12-24
				5 VDC	G3R-IDZR1SN-1-UTU DC5
			12 to 24 VDC	G3R-IDZR1SN-1-UTU DC12-24	

Output Modules for Standard Loads

Insulation method	Operation indicator	Zero cross function	Applicable load	Input rated voltage	Model
Phototriac	Yes	Yes	2 A at 100 to 240 VAC	5 to 24 VDC	G3R-OA202SZN-UTU DC5-24
		No			G3R-OA202SLN-UTU DC5-24
Photocoupler		---	2 A at 5 to 48 VDC		G3R-ODX02SN-UTU DC5-24
			1.5 A at 48 to 200 VDC		G3R-OD201SN-UTU DC5-24

Accessories (Order Separately)

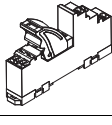
Connection Sockets

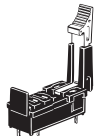
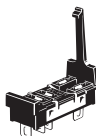
Classification	Terminal type	Appearance	Model
Front-mounting	Screw terminals		P2RFZ-05
	Screw terminals (finger protection structure)		P2RFZ-05-E
	Push-In Plus terminal blocks		P2RF-05-PU
Back-mounting	Relays with PCB Terminals		P2R-05P
			P2R-057P
	Solder terminals		P2R-05A

For Push-In Plus Terminal Block Sockets Short Bars

Applicable sockets	Pitch	Application	Shape/external dimensions	Number of poles	L (Length)	Insulation color	Short Bars Model*1	Maximum carry current
P2RF-05-PU	7.75 mm	Bridging Output terminals		2	15.1	Red (R) Blue (S) Yellow(Y)	PYDN-7.75-020□	20 A
				3	22.85		PYDN-7.75-030□	
				4	30.6		PYDN-7.75-040□	
				20	154.6		PYDN-7.75-200□	
	15.5 mm	Input terminals		8	115.55		PYDN-15.5-080□	

*1. Replace the box (□) in the model number with the code for the covering color. □Color selection: R = Red, S = Blue, Y = Yellow

Labels

Applicable sockets	Model
P2RF-05-PU	XW5Z-P4.0LB1 (1 sheet/60 pieces)

For Screw Terminal Sockets Short Bars

Applicable sockets	Pitch	Appearance	Dimensions (mm)	Number of poles	Insulation color	Short Bars Model	Maximum carry current	Minimum order (set)
P2RFZ-05-E	15.7 mm			10	Blue(S)	P2DN-15.7-100S	20 A	1
P2RFZ-05	19.4 mm			10	Blue(S)	P2DN-19.4-100S	20 A	1

Note: 1. Select an applicable type of short bars by checking applicable socket type, appearance, and dimensions.

2. Use the Short Bars for crossover wiring within one Socket or between Sockets.

3. Use the short bars on the lower section of the socket.

When using the short bars on the upper section of the socket, insert them so that their heads are pointed upwards (see the figure below). Otherwise, short bars may interfere with the socket, leading to improper wiring and contact failure.

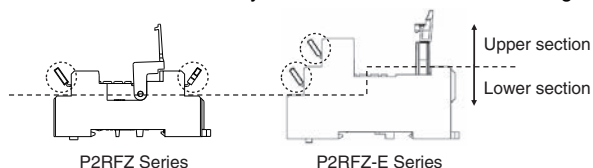

P2RFZ Series

P2RFZ-E Series

* One set (order unit) contains 10 short bars and 20 caps.

Accessories for Short Bars (P2DN) Cap

Short Bars Models	Appearance	Dimensions (mm)	Model
P2DN-19.4-100S P2DN-15.7-100S			P2DN-CP100

For Screw Terminal Sockets (P2RFZ-05)

Terminal covers

Applicable sockets	Appearance	Model	Minimum order (set)
P2RFZ-05		P2CZ-C	

- Note:** 1. Use these covers in a combination with P2RFZ-05.
 2. Do not install short bars (optional) on the upper section (see the figure below).
 Short bars may interfere with the terminal cover, making the terminal cover unusable.

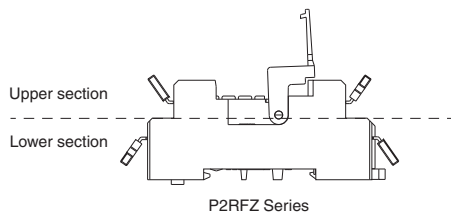

Dimensions with terminal cover

P2RFZ-05

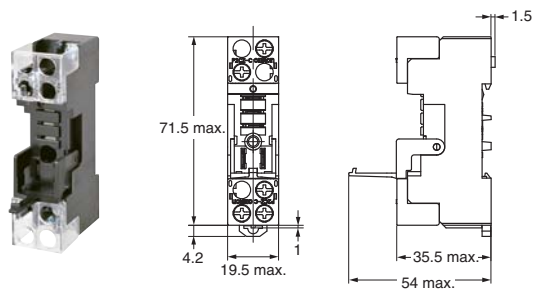



Labels

Applicable sockets	Model	Minimum order (sheet) (quantity per sheet)
P2RFZ-05-E	XW5Z-P2.5LB1	5 1 sheet (72 pieces)

Note: This label cannot be applied on sockets other than P2RFZ-05-E.

DIN Track Mounting Parts

Classification	Type	Appearance	Model
For front-mounting	DIN Tracks	Shallow type, total length: 1 m	PFP-100N
		Shallow type, total length: 0.5 m	PFP-50N
		Deep type, total length: 1 m	PFP-100N2
	End Plate		PFP-M
	Spacer		PFP-S
For back-mounting	Mounting Plates for Sockets * (For 5 Sockets)	---	P2R-P

* Used to mount several P2R-05A Connecting Sockets side by side.

Ratings and Specifications

Ratings

Input Modules for Microloads

Input Side

Model	Item	Rated voltage	Operating voltage	Input current	Must-operate voltage	Must-release voltage
G3R-IAZR1SN-UTU		100 to 240 VAC	60 to 264 VAC	15 mA max.	60 VAC max.	20 VAC min.
G3R-IDZR1SN-UTU		5 VDC	4 to 6 VDC	8 mA max.	4 VDC max.	1 VDC min.
G3R-IDZR1SN-UTU		12 to 24 VDC	6.6 to 32 VDC		6.6 VDC max.	3.6 VDC min.
G3R-IDZR1SN-1-UTU		5 VDC	4 to 6 VDC		4 VDC max.	1 VDC min.
G3R-IDZR1SN-1-UTU		12 to 24 VDC	6.6 to 32 VDC		6.6 VDC max.	3.6 VDC min.

Output Side

Model	Item	Load voltage	Load current
G3R-IAZR1SN-UTU		4 to 32 VDC	0.1 to 100 mA
G3R-IDZR1SN-UTU			
G3R-IDZR1SN-UTU			
G3R-IDZR1SN-1-UTU			
G3R-IDZR1SN-1-UTU			

Output Modules for Standard Loads

Input Side

Model	Item	Rated voltage	Operating voltage	Input current	Must-operate voltage	Must-release voltage
G3R-OA202SZN-UTU		5 to 24 VDC	4 to 32 VDC	15 mA max. (at 25° C)	4 VDC max.	1 VDC min.
G3R-OA202SLN-UTU						
G3R-ODX02SN-UTU				8mA max.		
G3R-OD201SN-UTU						

Output Side

Model	Item	Load voltage	Load current*1	Surge withstand current
G3R-OA202SZN-UTU		75 to 264 VAC	0.05 to 2 A*2	30 A (60 Hz, 1 cycle)
G3R-OA202SLN-UTU				
G3R-ODX02SN-UTU		4 to 60 VDC	0.01 to 2 A*2	8 A (10 ms)
G3R-OD201SN-UTU		40 to 200 VDC	0.01 to 1.5 A*2	8 A (10 ms)

*1. Depends on the ambient temperature. Refer to the reference data *Load Current vs. Ambient Temperature Rating* on page 6 for details.

*2. The minimum current value is for a temperature of 10°C or higher.

I/O External Display

Lineup includes Input Modules and Output Modules.

The I/O Module classification and AC/DC classification are also indicated in the markings on top of the Relay.

Marking	Specifications
AC IN	Input Modules for Microloads, AC input
DC IN	Input Modules for Microloads, DC input
AC OUT	Output Modules for Standard Loads, AC output
DC OUT	Output Modules for Standard Loads, DC output

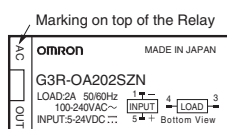

Characteristics

Input Modules for Microloads

Model	Item	G3R-IAZR1SN-UTU	G3R-IDZR1SN-UTU	G3R-IDZR1SN-1-UTU
Operation time		20 ms max.	0.1 ms max.	15 ms max.
Release time				
Response frequency		10 Hz	1 kHz	10 Hz
Output ON voltage drop		1.6 V max.		
Leakage current		5 μA max.		
Insulation resistance		100 MΩ min. between I/O		
Dielectric strength		4,000 VAC for 1 min. between I/O		
Vibration resistance		10 to 55 to 10 Hz, 0.75-mm single amplitude (1.5-mm double amplitude)		
Shock resistance		1,000 m/s ²		
Storage temperature		-30 to 100°C (with no icing)		
Ambient operating temperature		-30 to 80°C (with no icing)		
Ambient operating humidity		45% to 85% RH		
Weight		Approx. 18 g		
MTTFd (Reference value)		1,000 years min.		

Output Modules for Standard Loads

Model	Item	G3R-OA202SN-UTU	G3R-OA202SLN-UTU	G3R-ODX02SN-UTU	G3R-OD201SN-UTU
Operation time		1/2 load power supply cycle + 1 ms max.	1 ms max.		
Release time		1/2 load power supply cycle + 1 ms max.		2 ms max.	
Response frequency		20 Hz		100 Hz	
Output ON voltage drop		1.6 V max.			2.5 V max.
Leakage current		1.5 mA max.		1 mA max.	
Insulation resistance		100 MΩ min. between I/O			
Dielectric strength		4,000 VAC for 1 min. between I/O			
Vibration resistance		10 to 55 to 10 Hz, 0.75-mm single amplitude (1.5-mm double amplitude)			
Shock resistance		1,000 m/s ²			
Storage temperature		-30 to 100°C (with no icing)			
Ambient operating temperature		-30 to 80°C (with no icing)			
Ambient operating humidity		45% to 85% RH			
Weight		Approx. 18 g			
MTTFd (Reference value)		1,000 years min.			

Engineering Data

Load Current vs. Ambient Temperature Rating

G3R-OA202S□N-UTU

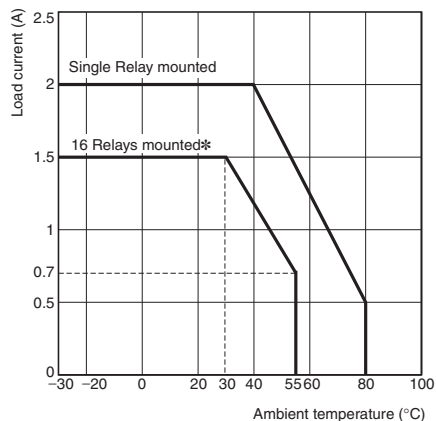

G3R-ODX02SN-UTU (4 to 60 VDC)

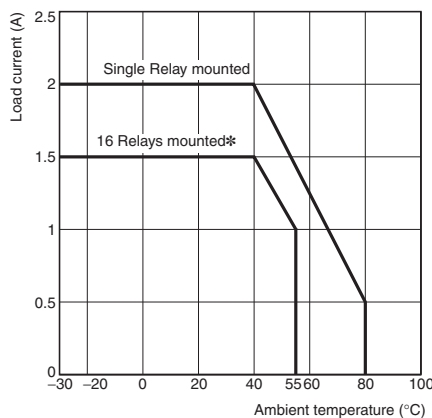

G3R-OD201SN-UTU (40 to 200 VDC)

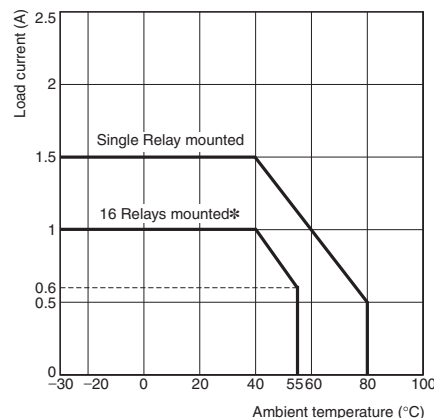

* On G70A-ZOC16, fully mounted.

Non-repetitive Surge Withstand Current (If repetitive, keep the inrush current below the dotted line.)

G3R-OA202S□N-UTU

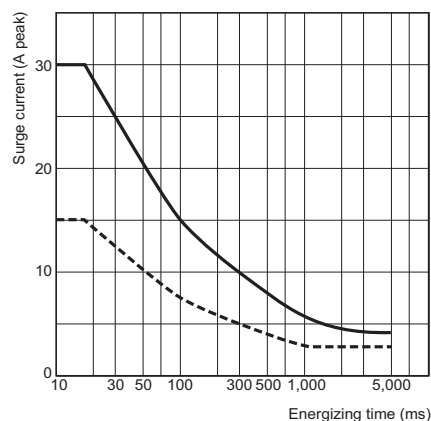

G3R-ODX02SN-UTU (4 to 60 VDC)

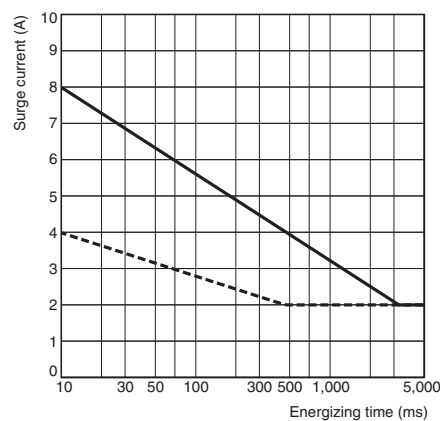

G3R-OD201SN-UTU (40 to 200 VDC)

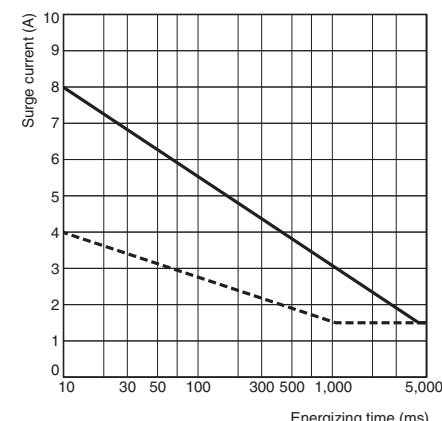

Dimensions

(Unit: mm)

Relay G3R-I/O

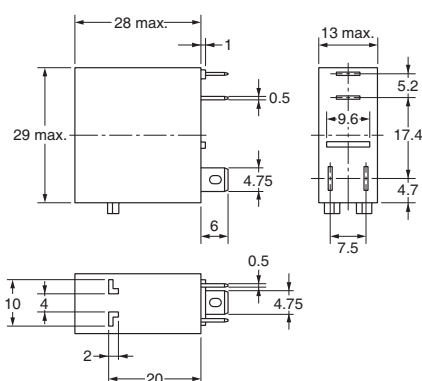

Terminal Arrangement/
Internal Connections
(Bottom View)

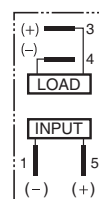

- Note:**
1. With AC input, the input side has no polarity.
 2. The load is possible to connect either + side or - side.

Accessories (Order Separately)

Socket Characteristics

Model	Rated carry current	Dielectric strength	Insulation resistance *	Remarks
P2RF-05-PU	10 A	Between contact terminals of same polarity: 1,000 VAC for 1 min	1,000 MΩ min.	
		Between coil and contact terminals: 4,000 VAC for 1 min		
P2RFZ-05(-E)	10 A	Between contact terminals of same polarity: 1,000 VAC for 1 min	1,000 MΩ min.	
		Between coil and contact terminals: 4,000 VAC for 1 min		
P2R-05P	10 A	Between contact terminals of same polarity: 1,000 VAC for 1 min	1,000 MΩ min.	
		Between coil and contact terminals: 4,000 VAC for 1 min		
P2R-057P	10 A	Between contact terminals of same polarity: 1,000 VAC for 1 min	1,000 MΩ min.	
		Between coil and contact terminals: 5,000 VAC for 1 min		
P2R-05A	10 A	Between contact terminals of same polarity: 1,000 VAC for 1 min	1,000 MΩ min.	
		Between ground terminals: 1,500 VAC for 1 min		
		Between coil and contact terminals: 4,000 VAC for 1 min		

* The insulation resistance was measured with a 500-VDC insulation resistance meter at the same places as those used for measuring the dielectric strength.

Track/Surface Mounting Sockets

P2RF-05-PU

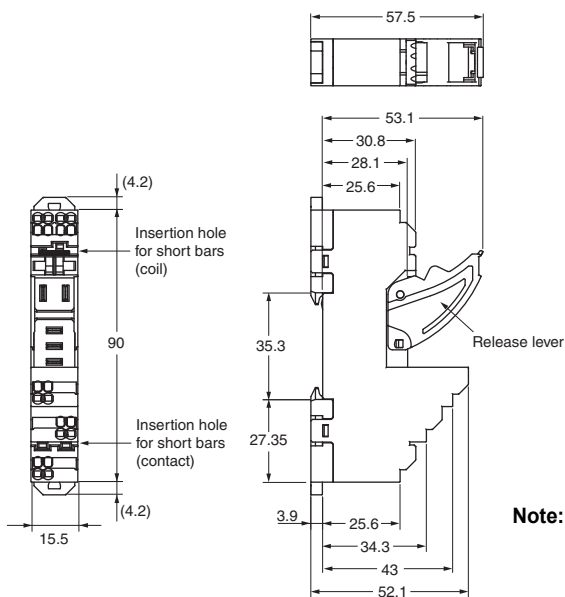

Terminal Arrangement/
Internal Connection Diagram
(Top View)

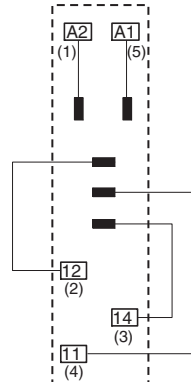

Mounting Hole
Dimensions

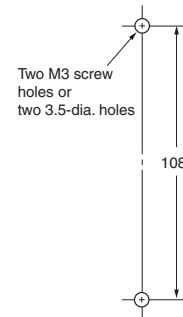

- Note:**
1. The numbers in parentheses are traditionally used terminal numbers.
 2. Insert the short bar into only the A1 or A2 side.
 3. Contact terminal crossover will result in functionality only on the No. 11 terminal side. The insertion hole on the No. 14 terminal side is a dummy hole for installing a short bar without bending the pins.

Note: Pull out the hooks to mount the Socket with screws.

P2RFZ-05-E

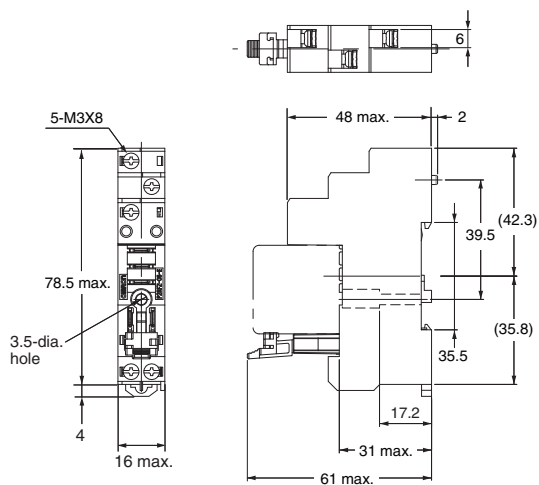

Terminal Arrangement/
Internal Connection Diagram
(Top View)

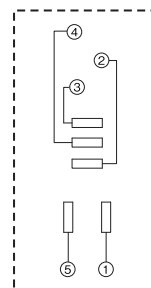

Mounting Hole
Dimensions

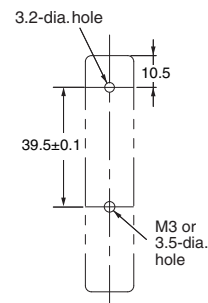

P2RFZ-05

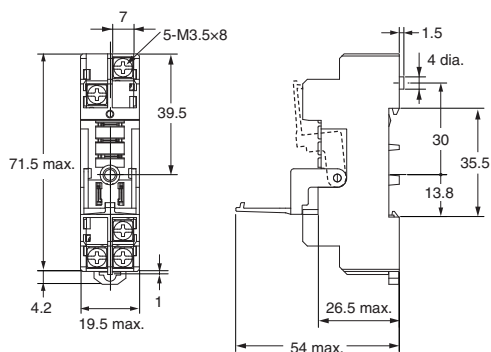

Terminal Arrangement/
Internal Connection Diagram
(Top View)

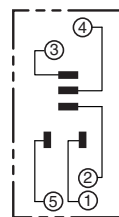

Mounting Hole
Dimensions

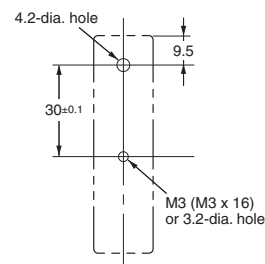

Mounting Height of Relay with Track/Surface Mounting Sockets

P2RF-05-PU

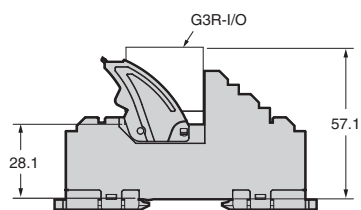

P2RFZ-05

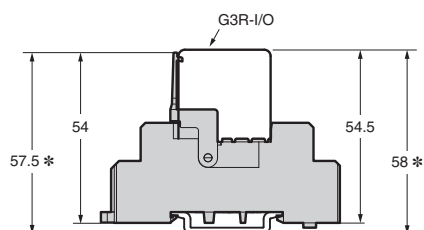

P2RFZ-05-E

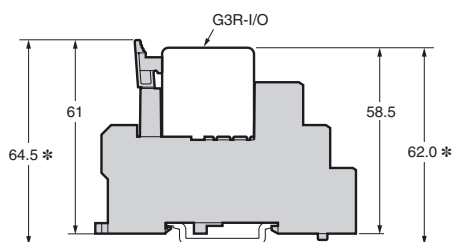

* These are values when using the DIN track PFP-□N.
Heights become higher by approximately 9 mm when using PFP-□N2.

Back-connecting Sockets

P2R-05P (1-pole)

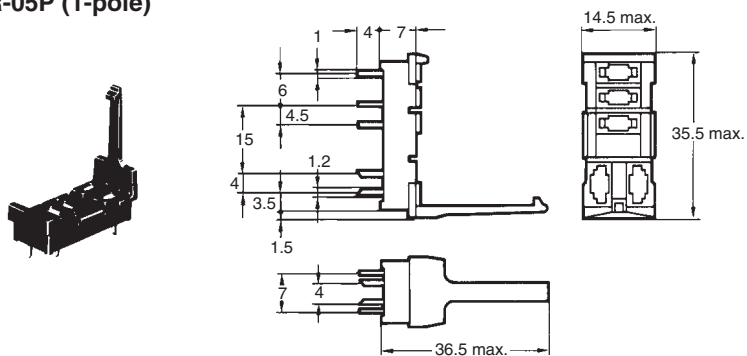

Terminal Arrangement (Bottom View)



Mounting Holes (Bottom View)

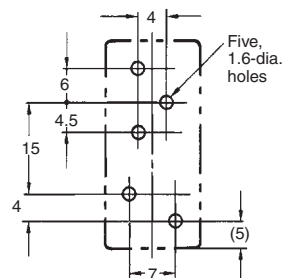

P2R-057P (1-pole)

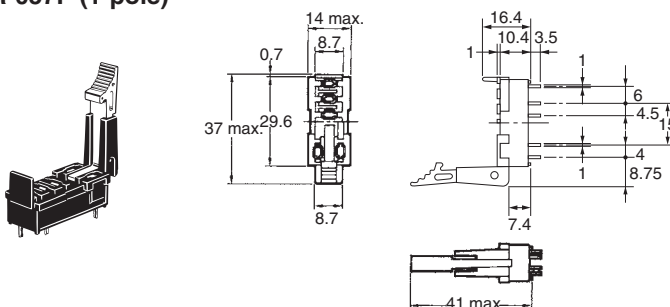

Terminal Arrangement (Bottom View)

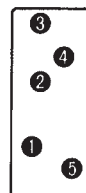

Mounting Holes (Bottom View)

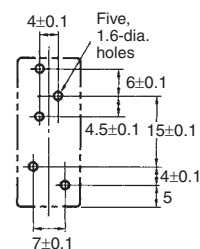

P2R-05A (1-pole)

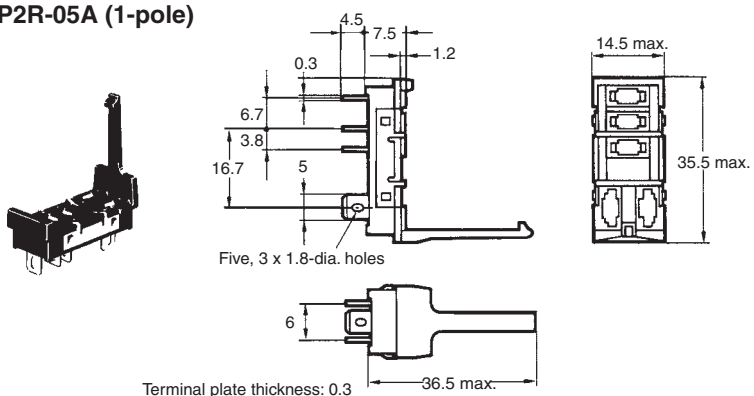

Terminal Arrangement (Bottom View)



Panel Cutout (Bottom View)

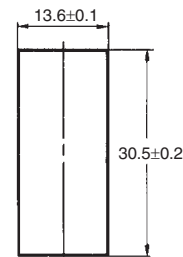

Recommended thickness of the panel is 1.6 to 2.0 mm

Mounting Height of Relay with Back-connecting Sockets

P2R-05P

P2R-05A

P2R-057P

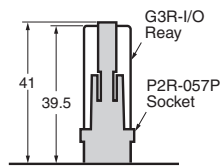
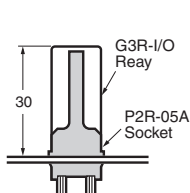
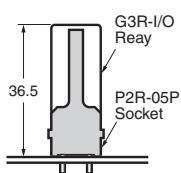

Mounting Tracks

PFP-100N, PFP-50N

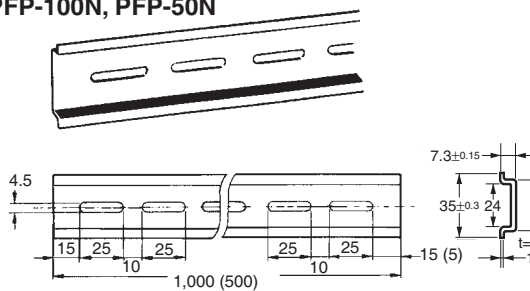

PFP-100N2

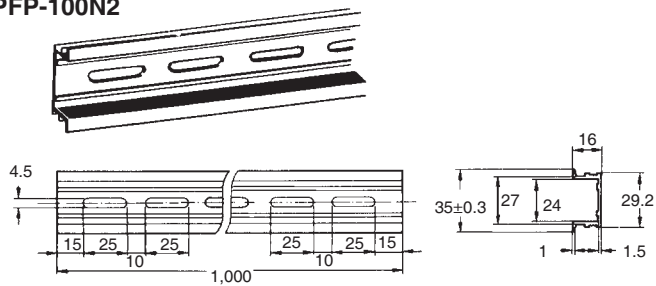

It is recommended to use a panel 1.6 to 2.0 mm thick.

End Plate

PFP-M

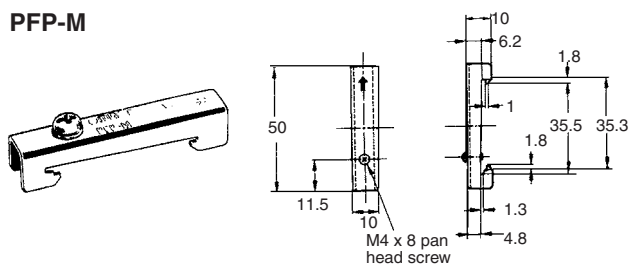

Spacer

PFP-S

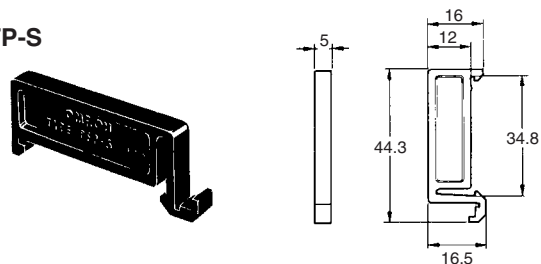

Mounting Plate

P2R-P

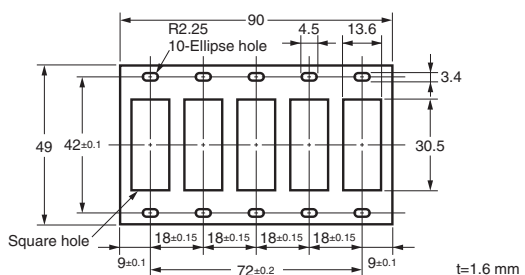

Safety Precautions

Be sure to read 'the Common Precautions' in the website at the following URL:

<http://www.ia.omron.com/>.

Refer to *Safety Precautions for All Solid State Relays* of your OMRON website.

Refer to *Products Related to Common Sockets and DIN Tracks* for precautions on the applicable Sockets of your OMRON website.

Refer to *PYF-□□-PU/P2RF-□□-PU* for precautions on Push-In Plus Terminal Block Sockets of your OMRON website.

Precautions for Correct Use	Supplementary comments on what to do or avoid doing to prevent failure to operate, malfunction, or undesirable effects on product performance.
------------------------------------	---

Precautions for Correct Use

About the Built-in Diodes

The diodes that are built into the Relays are designed to absorb reverse voltage from the Relay's coil. If a large surge in voltage is applied to the diode from an external source, the element will be destroyed.

If there is the possibility of large voltage surges that could be applied to the elements from an external source, take any necessary surge absorption measures.

Latching Levers

- Turn OFF the power supply when operating the latching lever. After you use the latching lever always return it to its original state.
- Do not use the latching lever as a switch.
- The latching lever can be used for 100 operations minimum.

Relay Replacement

To replace the Relay, turn OFF the power supply to the load and Relay coil sides to prevent unintended operation and possible electrical shock.

Coil tape color

Pink tape is used for the AC coil type and blue tape is used for the DC coil type, making it easy to distinguish AC and DC.

Using a short-circuit bar

- Use the short-circuit bar that is suitable for the socket you are using and the location of use.
- The short-circuit bar can be cut to match any number of poles. Cut with a tool as appropriate for the number of relays and sockets. When using a cut short-circuit bar, take care to avoid injuring yourself on the cut surface.
- When cutting with a tool, insert the tool from the plastic part and cut along the slot in the plastic part between terminals. If you cut a part other than the slot in the plastic part between terminals, it may not be possible to attach the insulating cap.

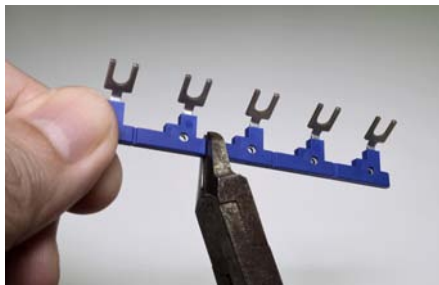

- When using a cut short-circuit bar (P2DN), always use the provided cap to protect the charger part.



- Use the short-circuit bar to short-circuit two or more output terminals, or two or more input terminals.
- Do not use a deformed short-circuit bar. Risk of failure, malfunctioning, or deterioration of characteristics.
- In socket terminals, insert the short-circuit bar in the correct orientation all the way into all terminals, and then secure with screws.
- Install the short -circuit bar before wiring.

Common connection method when using a short bar

When connecting the P2RF-□□-PU input common, insert the short bar into only the A1 or A2 side.

Equivalent Labels from Other Companies and Recommended Label Printers

Use the following label printer.

The following table gives the manufacturer's model number as of March 2017.

Manufacturer	Omron	Phoenix Contact	Weidmuller	Cembre
Label	XW5Z-P4.0LB1	UCT-TM6	MF 10/6	MG-CPM-04 41391
	XW5Z-P2.5LB2	UCT-TMF5	---	---
Label printer	---	BLUEMARK CLED, THERMOMA RK CARD SET PLUS, THERMOMA RK CARD	PrintJet ADVANCED, Plotter MCP Plus, Plotter MCP Basic	Markingenius MG3

* When using a printing tool, use a Phoenix Contact label printer.

Note: Ask the label manufacturer or printer manufacturer for details.

Terms and Conditions Agreement

Read and understand this catalog.

Please read and understand this catalog before purchasing the products. Please consult your OMRON representative if you have any questions or comments.

Warranties.

(a) Exclusive Warranty. Omron's exclusive warranty is that the Products will be free from defects in materials and workmanship for a period of twelve months from the date of sale by Omron (or such other period expressed in writing by Omron). Omron disclaims all other warranties, express or implied.

(b) Limitations. OMRON MAKES NO WARRANTY OR REPRESENTATION, EXPRESS OR IMPLIED, ABOUT NON-INFRINGEMENT, MERCHANTABILITY OR FITNESS FOR A PARTICULAR PURPOSE OF THE PRODUCTS. BUYER ACKNOWLEDGES THAT IT ALONE HAS DETERMINED THAT THE PRODUCTS WILL SUITABLY MEET THE REQUIREMENTS OF THEIR INTENDED USE.

Omron further disclaims all warranties and responsibility of any type for claims or expenses based on infringement by the Products or otherwise of any intellectual property right. (c) Buyer Remedy. Omron's sole obligation hereunder shall be, at Omron's election, to (i) replace (in the form originally shipped with Buyer responsible for labor charges for removal or replacement thereof) the non-complying Product, (ii) repair the non-complying Product, or (iii) repay or credit Buyer an amount equal to the purchase price of the non-complying Product; provided that in no event shall Omron be responsible for warranty, repair, indemnity or any other claims or expenses regarding the Products unless Omron's analysis confirms that the Products were properly handled, stored, installed and maintained and not subject to contamination, abuse, misuse or inappropriate modification. Return of any Products by Buyer must be approved in writing by Omron before shipment. Omron Companies shall not be liable for the suitability or unsuitability or the results from the use of Products in combination with any electrical or electronic components, circuits, system assemblies or any other materials or substances or environments. Any advice, recommendations or information given orally or in writing, are not to be construed as an amendment or addition to the above warranty.

See <http://www.omron.com/global/> or contact your Omron representative for published information.

Limitation on Liability: Etc.

OMRON COMPANIES SHALL NOT BE LIABLE FOR SPECIAL, INDIRECT, INCIDENTAL, OR CONSEQUENTIAL DAMAGES, LOSS OF PROFITS OR PRODUCTION OR COMMERCIAL LOSS IN ANY WAY CONNECTED WITH THE PRODUCTS, WHETHER SUCH CLAIM IS BASED IN CONTRACT, WARRANTY, NEGLIGENCE OR STRICT LIABILITY.

Further, in no event shall liability of Omron Companies exceed the individual price of the Product on which liability is asserted.

Suitability of Use.

Omron Companies shall not be responsible for conformity with any standards, codes or regulations which apply to the combination of the Product in the Buyer's application or use of the Product. At Buyer's request, Omron will provide applicable third party certification documents identifying ratings and limitations of use which apply to the Product. This information by itself is not sufficient for a complete determination of the suitability of the Product in combination with the end product, machine, system, or other application or use. Buyer shall be solely responsible for determining appropriateness of the particular Product with respect to Buyer's application, product or system. Buyer shall take application responsibility in all cases.

NEVER USE THE PRODUCT FOR AN APPLICATION INVOLVING SERIOUS RISK TO LIFE OR PROPERTY OR IN LARGE QUANTITIES WITHOUT ENSURING THAT THE SYSTEM AS A WHOLE HAS BEEN DESIGNED TO ADDRESS THE RISKS, AND THAT THE OMRON PRODUCT(S) IS PROPERLY RATED AND INSTALLED FOR THE INTENDED USE WITHIN THE OVERALL EQUIPMENT OR SYSTEM.

Programmable Products.

Omron Companies shall not be responsible for the user's programming of a programmable Product, or any consequence thereof.

Performance Data.

Data presented in Omron Company websites, catalogs and other materials is provided as a guide for the user in determining suitability and does not constitute a warranty. It may represent the result of Omron's test conditions, and the user must correlate it to actual application requirements. Actual performance is subject to the Omron's Warranty and Limitations of Liability.

Change in Specifications.

Product specifications and accessories may be changed at any time based on improvements and other reasons. It is our practice to change part numbers when published ratings or features are changed, or when significant construction changes are made. However, some specifications of the Product may be changed without any notice. When in doubt, special part numbers may be assigned to fix or establish key specifications for your application. Please consult with your Omron's representative at any time to confirm actual specifications of purchased Product.

Errors and Omissions.

Information presented by Omron Companies has been checked and is believed to be accurate; however, no responsibility is assumed for clerical, typographical or proofreading errors or omissions.

2024.11

In the interest of product improvement, specifications are subject to change without notice.

OMRON Corporation
Industrial Automation Company

<http://www.ia.omron.com/>

(c)Copyright OMRON Corporation 2024 All Right Reserved.