

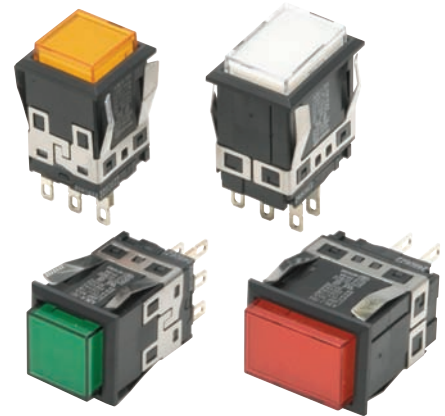

## Sense of Touch and Protection Ability Improved over OMRON's Previous Models. Miniature Design Achieved with Body Length of 23 mm.

- Combines miniature design with distinct but soft sense of operation.
- Five colors (red, yellow, green, white, and blue) with LEDs.
- Improved sense of touch with built-in Basic Switch.
- Built-in Basic Switch improves protection over OMRON's previous models.
- Chip LED produces even surface brightness.
- Easy panel mounting from the front.



 Refer to *Safety Precautions for All Pushbutton Switches/Indicators* and *Safety Precautions* on page 15.

## List of Models

### Lighted Pushbutton Switches

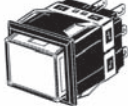
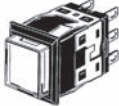
| Appearance   | Model |
|--|-------|
| Rectangular<br> | A3KJ  |
| Square<br>      | A3KA  |

■ Specifications: Refer to page 10.

■ Dimensions: Refer to page 12.

■ Accessories: Refer to pages 8 to 9.

# Model Number Structure

**Model Number Legend** ..... The model numbers used to order sets of Units are illustrated below. One set comprises the Operation Unit (LED built in) and Socket Unit.  
For information on combinations, refer to *Ordering Information* on page 3.

(3) (4) (5)  
**1** - **24E** **R** ..... Single screen

(1) (2) Upper Lower  
**A3KJ** - **90A2** - **24E** **RW** ..... Horizontal 2-split screen

|           |       |
|-----------|-------|
| R (Red)   | Upper |
| W (White) | Lower |

**(1) Shape of Operation Unit**

| Symbol | Shape       |
|--------|-------------|
| J      | Rectangular |
| A      | Square      |

**(2) Switch Specifications Standard Load**

| Symbol | Operation | Contacts |
|--------|-----------|----------|
| A      | Momentary | SPDT     |
| B      | Alternate |          |
| C      | Momentary | DPDT     |
| D      | Alternate |          |

**Microload**

| Symbol | Operation | Contacts |
|--------|-----------|----------|
| E      | Momentary | SPDT     |
| F      | Alternate |          |
| G      | Momentary | DPDT     |
| H      | Alternate |          |

- Standard Load  
250 VAC, 3 A  
30 VDC, 3 A
- Microload  
125 VAC, 0.1 A  
30 VDC, 0.1 A
- Minimum applicable load  
5 VDC, 1 mA
- ▶ **Momentary operation: Self-resetting**
- ▶ **Alternate operation: Self-holding**

**(3) Screen Pattern Illumination-only models**

| Symbol | Screen pattern   |
|--------|--|
| 1      | Single screen<br> |

|   |   |
|---|---|
| 2 | Horizontal 2-split screen<br><br>(rectangular models only) |
|---|---|

The screen patterns listed below can be ordered individually. Refer to page 6 for details.

|  |   |
|--|---|
|  | Vertical 2-split screen<br><br>(rectangular models only) |
|--|---|

**(4) Lighting Method**

| Symbol | Operating voltage |
|--------|-------------------|
| 05E    | 5 VDC             |
| 12E    | 12 VDC            |
| 24E    | 24 VDC            |



• Only for LED models.

**(5) Color of Display**

| Symbol | Color  |
|--------|--|
| R      | Red  |
| Y      | Yellow   |
| G      | Green  |
| W      | White  |
| A      | Blue   |
| K      | Red/green 2-color lighting (rectangular models only) |

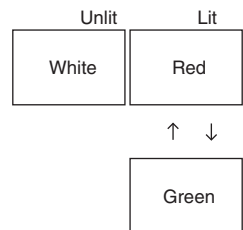
▶ **Red/green 2-color lighting:**

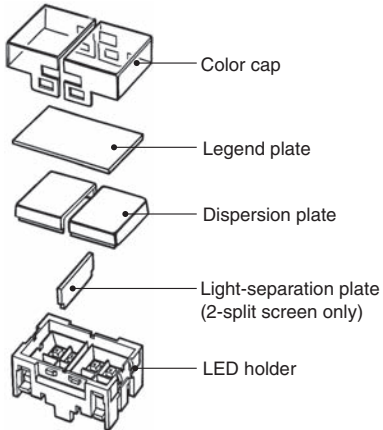

| Type  | Structure of Split-screen Operation Unit<br>(Example: Vertical 2-split screen)  |
|---|---|
| <br>Single-screen models<br>(rectangular and square models)  |  <ul style="list-style-type: none"> <li>Color cap</li> <li>Legend plate</li> <li>Dispersion plate</li> <li>Light-separation plate (2-split screen only)</li> <li>LED holder</li> </ul> |
| <br>Vertical 2-split screen models<br>(See note 1.)<br>(rectangular models only)   |   |
| <br>Horizontal 2-split screen models<br>(rectangular models only)  |   |
| <p>Note: 1. Vertical 2-split screen models can be ordered only individually. Refer to page 6.<br/>                     2. A legend plate and LED (with current-limiting resistor) are built into a standard Display.<br/>                     3. Split-screen color configurations are given with the OMRON mark on the Switch facing down.<br/>                     4. The built-in legend plate is milk-white in color.</p> |   |

## Ordering Information

**Sets**..... Sets include an Operation Unit (LED built in) and a Switch.  
 Not all combinations are possible. Ask your OMRON representative for details.

### Standard Loads

Rectangular Models



A3KJ

Standard Loads

| Screen pattern            | Output | Contact type<br>Operation               | Standard load (250 VAC, 3 A; 30 VDC, 3 A) |   | Operation Unit color symbol   |   |   |
|---------------------------|--------|---|---|---|---|---|---|
|                           |        |   | Momentary operation (Self-resetting)      | Alternate operation (Self-holding)      |   |   |   |
| Single screen             | SPDT   | 5 VDC                                   | A3KJ-90A1-05E <sup>1</sup>                | A3KJ-90B1-05E <sup>1</sup>              | Insert a color symbol in <sup>1</sup> at the end of the model number.<br>R (red), W (white)<br>Y (yellow), A (blue)<br>G (green), K (red/green)   |   |   |
|                           |        | 12 VDC                                  | A3KJ-90A1-12E <sup>1</sup>                | A3KJ-90B1-12E <sup>1</sup>              |   |   |   |
|                           |        | 24 VDC                                  | A3KJ-90A1-24E <sup>1</sup>                | A3KJ-90B1-24E <sup>1</sup>              |   |   |   |
|                           | DPDT   | 5 VDC                                   | A3KJ-90C1-05E <sup>1</sup>                | A3KJ-90D1-05E <sup>1</sup>              |   |   |   |
|                           |        | 12 VDC                                  | A3KJ-90C1-12E <sup>1</sup>                | A3KJ-90D1-12E <sup>1</sup>              |   |   |   |
|                           |        | 24 VDC                                  | A3KJ-90C1-24E <sup>1</sup>                | A3KJ-90D1-24E <sup>1</sup>              |   |   |   |
| Horizontal 2-split screen | SPDT   | 24 VDC                                  | A3KJ-90A2-24E <sup>1</sup> <sup>2</sup>   | A3KJ-90B2-24E <sup>1</sup> <sup>2</sup> | <table border="1" style="margin-left: auto; margin-right: auto;"> <tr><td style="text-align: center;">1</td></tr> <tr><td style="text-align: center;">2</td></tr> </table> Insert color symbols in <sup>1</sup> and <sup>2</sup> at the end of the model number.<br>R (red), W (white)<br>Y (yellow), A (blue)<br>Green | 1 | 2 |
|                           | 1      |   |   |   |   |   |   |
| 2                         |        |   |   |   |   |   |   |
| DPDT                      | 24 VDC | A3KJ-90C2-24E <sup>1</sup> <sup>2</sup> | A3KJ-90D2-24E <sup>1</sup> <sup>2</sup>   |   |   |   |   |

Microloads

| Screen pattern            | Output | Contact type<br>Operation | Microload<br>(125 VAC, 0.1 A; 30 VDC, 0.1 A) | Operation Unit color symbol   |   |   |
|---------------------------|--------|---------------------------|--|---|---|---|
|                           |        |                           | Momentary operation (Self-resetting)         |   |   |   |
| Single screen             | SPDT   | 5 VDC                     | A3KJ-90E1-05E <sup>1</sup>                   | Insert a color symbol in the <sup>1</sup> at the end of the model number.<br>R (red), W (white)<br>Y (yellow), A (blue)<br>G (green), K (red/green)   |   |   |
|                           |        | 12 VDC                    | A3KJ-90E1-12E <sup>1</sup>                   |   |   |   |
|                           |        | 24 VDC                    | A3KJ-90E1-24E <sup>1</sup>                   |   |   |   |
|                           | DPDT   | 5 VDC                     | A3KJ-90G1-05E <sup>1</sup>                   |   |   |   |
|                           |        | 12 VDC                    | A3KJ-90G1-12E <sup>1</sup>                   |   |   |   |
|                           |        | 24 VDC                    | A3KJ-90G1-24E <sup>1</sup>                   |   |   |   |
| Horizontal 2-split screen | SPDT   | 24 VDC                    | A3KJ-90E2-24E <sup>1</sup> <sup>2</sup>      | <table border="1" style="margin-left: auto; margin-right: auto;"> <tr><td style="text-align: center;">1</td></tr> <tr><td style="text-align: center;">2</td></tr> </table> Insert color symbols in <sup>1</sup> and <sup>2</sup> at the end of the model number.<br>R (red), W (white)<br>Y (yellow), A (blue)<br>G (green) | 1 | 2 |
| 1                         |        |                           |  |   |   |   |
| 2                         |        |                           |  |   |   |   |

Note: Alternate operation models are also available. Refer to page 7 for model numbers.

Individual models: Refer to pages 5 to 7.  
 (The Pushbutton and Switch can be ordered separately.)

- Specifications: Refer to page 10.
- Dimensions: Refer to page 12.
- Accessories: Refer to pages 8 to 9.

## Ordering Information

**Sets** ..... Sets include an Operation Unit (LED built in) and a Socket Unit.

Square Models



A3KA

Standard Loads

| Screen pattern | Output | Contact type<br>Operation | Standard load (250 VAC, 3 A; 30 VDC, 3 A) |                                    | Operation Unit color<br>symbol   |
|----------------|--------|---------------------------|---|------------------------------------|--|
|                |        |                           | Momentary operation (Self-resetting)      | Alternate operation (Self-holding) |  |
| Single screen  | SPDT   | 5 VDC                     | A3KA-90A1-05E <sup>1</sup>                | A3KA-90B1-05E <sup>1</sup>         | Insert a color symbol in <sup>1</sup><br>at the end of the model<br>number.<br>R (red), Y (yellow)<br>G (green), W (white)<br>A (blue) |
|                |        | 12 VDC                    | A3KA-90A1-12E <sup>1</sup>                | A3KA-90B1-12E <sup>1</sup>         |  |
|                |        | 24 VDC                    | A3KA-90A1-24E <sup>1</sup>                | A3KA-90B1-24E <sup>1</sup>         |  |
|                | DPDT   | 5 VDC                     | A3KA-90C1-05E <sup>1</sup>                | A3KA-90D1-05E <sup>1</sup>         |  |
|                |        | 12 VDC                    | A3KA-90C1-12E <sup>1</sup>                | A3KA-90D1-12E <sup>1</sup>         |  |
|                |        | 24 VDC                    | A3KA-90C1-24E <sup>1</sup>                | A3KA-90D1-24E <sup>1</sup>         |  |

Microloads

| Screen pattern | Output | Contact type<br>Operation | Microload<br>(125 VAC, 0.1 A; 30 VDC, 0.1 A) | Operation Unit color<br>symbol   |
|----------------|--------|---------------------------|--|--|
|                |        |                           | Momentary operation (Self-resetting)         |  |
| Single screen  | SPDT   | 5 VDC                     | A3KA-90E1-05E <sup>1</sup>                   | Insert a color symbol in <sup>1</sup><br>at the end of the model<br>number.<br>R (red), Y (yellow)<br>G (green), W (white)<br>A (blue) |
|                |        | 12 VDC                    | A3KA-90E1-12E <sup>1</sup>                   |  |
|                |        | 24 VDC                    | A3KA-90E1-24E <sup>1</sup>                   |  |
|                | DPDT   | 5 VDC                     | A3KA-90G1-05E <sup>1</sup>                   |  |
|                |        | 12 VDC                    | A3KA-90G1-12E <sup>1</sup>                   |  |
|                |        | 24 VDC                    | A3KA-90G1-24E <sup>1</sup>                   |  |

Note: Alternate operation models are also available. Refer to page 7 for model numbers.

Individual models: Refer to pages 5 to 7.  
(The Pushbutton and Switch can be ordered separately.)

- Specifications: Refer to page 10.
- Dimensions: Refer to page 12.
- Accessories: Refer to pages 8 to 9.

## Ordering Information

**Ordering Individually** ..... Operation Units (LED built in) and Socket Units can be ordered separately. Combinations that are not available as sets can be created using individual Units. Parts can also be stored as spares for maintenance and repairs.

**Ordering** ..... Specify a model number from the following page.

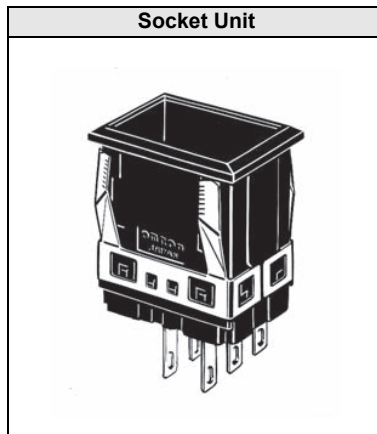
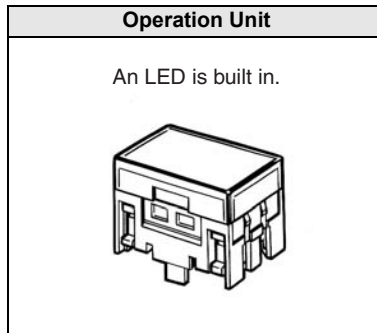

Ordering set combinations: Refer to pages 3 to 4.















■ Specifications: Refer to page 10.      ■ Dimensions: Refer to page 12.  
■ Accessories: Refer to pages 8 to 9.

## Ordering Information

### Operation Units

#### LED-lighted Models (LED chip built in)

Not all combinations are possible. Ask your OMRON representative for details.

| Appearance  | Screen pattern  | Color  | White (W)                | Red (R)                  | Green (G)                | Blue (A)                 | Yellow (Y)               | Selection precautions   |
|---|---|--|--------------------------|--------------------------|--------------------------|--------------------------|--------------------------|---|
| Rectangular Models (A3KJ)<br> | Single screen   |   | <b>A3KJ-51W</b><br>-□□E  | <b>A3KJ-51R</b><br>-□□E  | <b>A3KJ-51G</b><br>-□□E  | <b>A3KJ-51A</b><br>-□□E  | <b>A3KJ-51Y</b><br>-□□E  | <ul style="list-style-type: none"> <li>Enter the voltage to be used in the □□ at the end of the model number. Examples of voltages used:<br/>5V=0 5 E<br/>12V=1 2 E<br/>24V=2 4 E</li> <li>Two-split screen models are available only for 24 V.</li> <li>For the color of the shaded part, select the model according to the colors given at the top of the table.</li> </ul> |
|   | Horizontal 2-split screen   |   | <b>A3KJ-52WW</b><br>-□□E | <b>A3KJ-52WR</b><br>-24E | <b>A3KJ-52WG</b><br>-24E | —                        | —                        |   |
|   |   |   | <b>A3KJ-52RW</b><br>-□□E | <b>A3KJ-52RR</b><br>-24E | <b>A3KJ-52RG</b><br>-□□E | —                        | —                        |   |
|   |   |   | <b>A3KJ-52GW</b><br>-□□E | <b>A3KJ-52GR</b><br>-12E | <b>A3KJ-52GG</b><br>-□□E | <b>A3KJ-52GA</b><br>-24E | <b>A3KJ-52GY</b><br>-□□E |   |
|   |   |   | <b>A3KJ-52AW</b><br>-24E | <b>A3KJ-52AR</b><br>-24E | <b>A3KJ-52AG</b><br>-24E | —                        | <b>A3KJ-52AY</b><br>-24E |   |
|   |   |   | <b>A3KJ-52YW</b><br>-□□E | —                        | <b>A3KJ-52YG</b><br>-□□E | —                        | <b>A3KJ-52YY</b><br>-05E |   |
|   | Vertical 2-split screen   |   | <b>A3KJ-53WW</b><br>-24E | —                        | <b>A3KJ-53WG</b><br>-24E | —                        | —                        |   |
|   |   |   | <b>A3KJ-53RW</b><br>-12E | —                        | <b>A3KJ-53RG</b><br>-□□E | —                        | —                        |   |
|   |   |   | —                        | <b>A3KJ-53GR</b><br>-□□E | —                        | <b>A3KJ-53GA</b><br>-12E | —                        |   |
|   |   |   | —                        | —                        | <b>A3KJ-53YG</b><br>-24E | —                        | —                        |   |
| Two-color full illumination (red/green)   | <br>↓<br> | <b>A3KJ-57K</b><br>-□□E  |                          |                          |                          |                          |                          |   |
| Square Models (A3KA)<br>    | Single screen   |  | <b>A3KA-51W</b><br>-□□E  | <b>A3KA-51R</b><br>-□□E  | <b>A3KA-51G</b><br>-□□E  | <b>A3KA-51A</b><br>-□□E  | <b>A3KA-51Y</b><br>-□□E  |   |



- Note: 1. A legend plate and LED (with current-limiting resistor) are built into a standard Display.  
 2. Split-screen color configurations are given with the OMRON mark on the Switch facing down.  
 3. The built-in legend plate is milk-white in color.

Ordering set combinations: Refer to pages 3 to 4.

- Specifications: Refer to page 10.
- Dimensions: Refer to page 12.
- Accessories: Refer to pages 8 to 9.

## Ordering Information

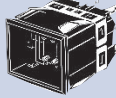
### Socket Units

| Appearance    |                          |           |                     | Rectangular models<br> | Square models<br> | Selection precautions   |
|---------------|--------------------------|-----------|---------------------|---|---|---|
| Contact type  | Number of Switch outputs | Operation |                     | Model   | Model   |   |
| Standard load | Silver alloy contacts    | 1         | Momentary operation | A3KJ-7010   | A3KA-7010   | <ul style="list-style-type: none"> <li>Use the Socket Unit in combination with the same shape Operation Unit (rectangular or square).<br/>Example:<br/>For A3KJ-51W-24E Rectangular Operation Unit, select the A3KJ-7□□0 Socket Unit.</li> <li>Momentary operation is self-resetting, and alternate operation is self-holding (i.e., push-on, push-off).</li> </ul> |
|               |                          |           | Alternate operation | A3KJ-7020   | A3KA-7020   |   |
|               |                          | 2         | Momentary operation | A3KJ-7030   | A3KA-7030   |   |
|               |                          |           | Alternate operation | A3KJ-7040   | A3KA-7040   |   |
| Microload     | Gold alloy contacts      | 1         | Momentary operation | A3KJ-7050   | A3KA-7050   |   |
|               |                          |           | Alternate operation | A3KJ-7060   | A3KA-7060   |   |
|               |                          | 2         | Momentary operation | A3KJ-7070   | A3KA-7070   |   |
|               |                          |           | Alternate operation | A3KJ-7080   | A3KA-7080   |   |





Ordering set combinations: Refer to pages 3 to 4.

- Specifications: Refer to page 10.
- Dimensions: Refer to page 12.
- Accessories: Refer to pages 8 to 9.





## Ordering Information

### Accessories, Replacements, and Tools (Order Separately)

#### Accessories for Rectangular Models

| Name                | Appearance  | Classification               | Model            | Application Precautions   |
|---------------------|---|------------------------------|------------------|---|
| Barrier             |  | Short Edge Barriers (1 pair) | <b>A3SA-4001</b> | The purpose of a Barrier is to prevent malfunctioning and to improve design image of the mounting panel.<br>There is one Intermediate Barrier and one pair of Edge Barriers (i.e., two Barriers).<br>Mount Short Barriers horizontally. Mount Long Barriers vertically. |
|                     |   | Short Intermediate Barrier   | <b>A3SA-4002</b> |   |
|                     |   | Long Edge Barriers (1 pair)  | <b>A3SJ-4003</b> |   |
|                     |   | Long Intermediate Barrier    | <b>A3SJ-4004</b> |   |
| Switch Guard        |  | —                            | <b>A3SJ-5050</b> | Cannot be used with Barriers or Seal Cover.   |
| Seal Cover          |  | —                            | <b>A3SJ-5060</b> | <ul style="list-style-type: none"> <li>Cannot be used with Barriers or Switch Guard.</li> <li>Cap material: Vinyl chloride</li> </ul>   |
| Long Mounting Plate |  | —                            | <b>A3KJ-3002</b> | Use when vertically mounting individual (with Barrier) or multiple Switches (in standard mounting style and with Barriers). A Short Mounting Plate is attached to the Switch, so replace it with a long one.  |
| Color cap           |  | Transparent                  | <b>A3SJ-5600</b> | <ul style="list-style-type: none"> <li>The color cap is normally mounted. Contact your OMRON representative for color changes or inscribing.</li> <li>Use a color that matches the Display color.</li> </ul>  |
|                     |   | White                        | <b>A3SJ-5601</b> |   |
|                     |   | Red                          | <b>A3SJ-5602</b> |   |
|                     |   | Green                        | <b>A3SJ-5603</b> |   |
|                     |   | Blue                         | <b>A3SJ-5604</b> |   |
|                     |   | Yellow                       | <b>A3SJ-5605</b> |   |

#### Accessories for Square Models

| Name         | Appearance  | Classification               | Model            | Application Precautions  |
|--------------|---|------------------------------|------------------|--|
| Barrier      |  | Short Edge Barriers (1 pair) | <b>A3SA-4001</b> | The purpose of a Barrier is to prevent malfunctioning and to improve design image of the mounting panel.   |
|              |   | Short Intermediate Barrier   | <b>A3SA-4002</b> |  |
| Switch Guard |  | —                            | <b>A3SA-5050</b> | Cannot be used with Barriers or Seal Cover.  |
| Seal Cover   |  | —                            | <b>A3SA-5060</b> | <ul style="list-style-type: none"> <li>Cannot be used with Barriers or Switch Guard.</li> <li>Cap material: Vinyl chloride</li> </ul>  |
| Color cap    |  | Transparent                  | <b>A3SA-5600</b> | <ul style="list-style-type: none"> <li>The color cap is normally mounted. Contact your OMRON representative for color changes or inscribing.</li> <li>Use a color that matches the Display color.</li> </ul> |
|              |   | White                        | <b>A3SA-5601</b> |  |
|              |   | Red                          | <b>A3SA-5602</b> |  |
|              |   | Green                        | <b>A3SA-5603</b> |  |
|              |   | Blue                         | <b>A3SA-5604</b> |  |
|              |   | Yellow                       | <b>A3SA-5605</b> |  |

■ Specifications: Refer to page 10.

■ Dimensions: Refer to page 12.

■ Accessory mounting: Refer to page 16.



## Ordering Information

### Tools for Rectangular Models

| Name      | Appearance  | Classification | Model     | Application precautions                       |
|-----------|---|----------------|-----------|---|
| Extractor |  | —              | A3PJ-5080 | Convenient for extracting the Operation Unit. |

### Replacements for Rectangular Models

| Name         | Appearance  | Classification    | Model     | Application precautions                             |
|--------------|---|-------------------|-----------|---|
| Legend plate |  | Milk-white<br>LED | A3SJ-4203 | All colors have a milk-white legend plate built in. |

### Replacements for Square Models

| Name         | Appearance  | Classification    | Model     | Application precautions                             |
|--------------|---|-------------------|-----------|---|
| Legend plate |  | Milk-white<br>LED | A3SA-4203 | All colors have a milk-white legend plate built in. |

■ Specifications: Refer to page 10.  
 ■ Accessory mounting: Refer to page 16.

■ Dimensions: Refer to page 12.

## Specifications

### Approved Standard Ratings

#### UL (File No. E41515), CSA (File No. LR45258)

Standard Load: 3 A at 250 VAC  
5 A at 125 VAC  
3 A at 30 VDC

Microload: 0.1 A at 125 VAC  
0.1 A at 30 VDC

Note: Certification has been obtained for the Switch Unit.  
For detailed information on individual products that have received certification, consult your supplier.

#### CCC (GB/T14048.5)

Standard Load: 3 A at 250 VAC  
4 A at 30 VDC  
3 A at 30 VDC

Microload: 0.1 A at 125 VAC  
0.1 A at 30 VDC

### Ratings

#### Standard Load

| AC resistive load                | DC resistive load |
|----------------------------------|-------------------|
| 3 A at 250 VAC<br>5 A at 125 VAC | 3 A at 30 VDC     |

Note: The above ratings are from testing under the following conditions:

- 1) Ambient temperature: 20 ± 2°C
- 2) Ambient humidity: 65% ± 5%RH
- 3) Operation frequency: 20 operations/min

#### Microload

|                         |   |
|-------------------------|---|
| Rating                  | 0.1 A, 30 VDC (resistive load)<br>0.1 A, 125 VAC (resistive load) |
| Minimum applicable load | 1 mA, 5 VDC   |

### LED-lighted Models

#### Rectangular Models (A3KJ)

| Operating voltage | Rated voltage | Rated current   |
|-------------------|---------------|-----------------|
| 5 VDC ± 5%        | 5 VDC         | 48 mA (18 mA) * |
| 12 VDC ± 5%       | 12 VDC        | 20 mA (10 mA) * |
| 24 VDC ± 5%       | 24 VDC        | 10 mA (5 mA) *  |

\* Values are for blue illumination.

#### Square Models (A3KA)

| Operating voltage | Rated voltage | Rated current   |
|-------------------|---------------|-----------------|
| 5 VDC ± 5%        | 5 VDC         | 24 mA (10 mA) * |
| 12 VDC ± 5%       | 12 VDC        | 24 mA (10 mA) * |
| 24 VDC ± 5%       | 24 VDC        | 12 mA (5 mA) *  |

\* Values are for blue illumination.

### Characteristics

|                                 |   |   |
|---------------------------------|---|---|
| Operating frequency             | Mechanical  | Momentary-action models: 120 operations/min max. *1   |
|                                 | Electrical  | 20 operations/min max.  |
| Insulation resistance           |   | 100 MΩ min. (at 500 VDC)  |
| Contact resistance              | Standard load   | 50 mΩ max. (initial value)  |
|                                 | Microload   | 50 mΩ max. (initial value)  |
| Dielectric strength             | Between terminals of same polarity                        | 1,000 VAC, 50/60 Hz for 1 minute  |
|                                 | Between terminals of different polarity                   | 2,000 VAC, 50/60 Hz for 1 minute  |
|                                 | Between current-carrying metal part and ground            | 2,000 VAC, 50/60 Hz for 1 minute  |
|                                 | Between each terminal and non-current-carrying metal part | 2,000 VAC, 50/60 Hz for 1 minute  |
|                                 | Between lamp terminals                                    | 1,000 VAC, 50/60 Hz for 1 minute *2   |
| Vibration resistance            | Malfunction   | 10 to 55 Hz, 1.5-mm double amplitude *3   |
| Shock resistance                | Destruction   | 500 m/s <sup>2</sup> max.   |
|                                 | Malfunction   | 200 m/s <sup>2</sup> max. *3  |
| Durability                      | Mechanical  | Momentary operation models: 2,000,000 operations min.<br>Alternate operation models: 200,000 operations min.<br>One operation cycle consists of set and reset operations. |
|                                 | Electrical  | 100,000 operations min. (rated load)  |
| Weight                          |   | Approx. 10 g  |
| Ambient operating temperature   |   | -10 to 50 °C (with no icing or condensation)  |
| Ambient operating humidity      |   | 35% to 85%RH  |
| Ambient storage temperature     |   | -25 to 65 °C (with no icing or condensation)  |
| Degree of protection            |   | IP00  |
| Electric shock protection class |   | Class II  |
| PTI (proof tracking index)      |   | 175   |
| Pollution degree                |   | 3 (IEC 60947-5-1)   |

\*1. Alternate-action models: 60 operations/min max.  
(One operation cycle consists of set and reset operations.)

\*2. The figure is for when no LED is mounted.

\*3. Malfunction: 1 ms max.

### Operating Characteristics

| Operating Characteristics          | Momentary operation | Alternate operation |
|------------------------------------|---------------------|---------------------|
| Operating force (OF) max.          | 3.92 N              | 4.90 N              |
| Releasing force (RF) min.          | 0.49 N              | 0.294 N             |
| Total travel (TT)                  | Approx. 3 mm        | Approx. 3 mm        |
| Pretravel (PT) max.                | 2.5 mm              | 2.5 mm              |
| Lock travel alternate (LTA) min. * | —                   | 0.5 mm              |

\* Alternate operation models only.

### Contact Form

| Contact name          | Contact form |
|-----------------------|--------------|
| Double-throw contacts |              |

# Nomenclature

## Model Structure

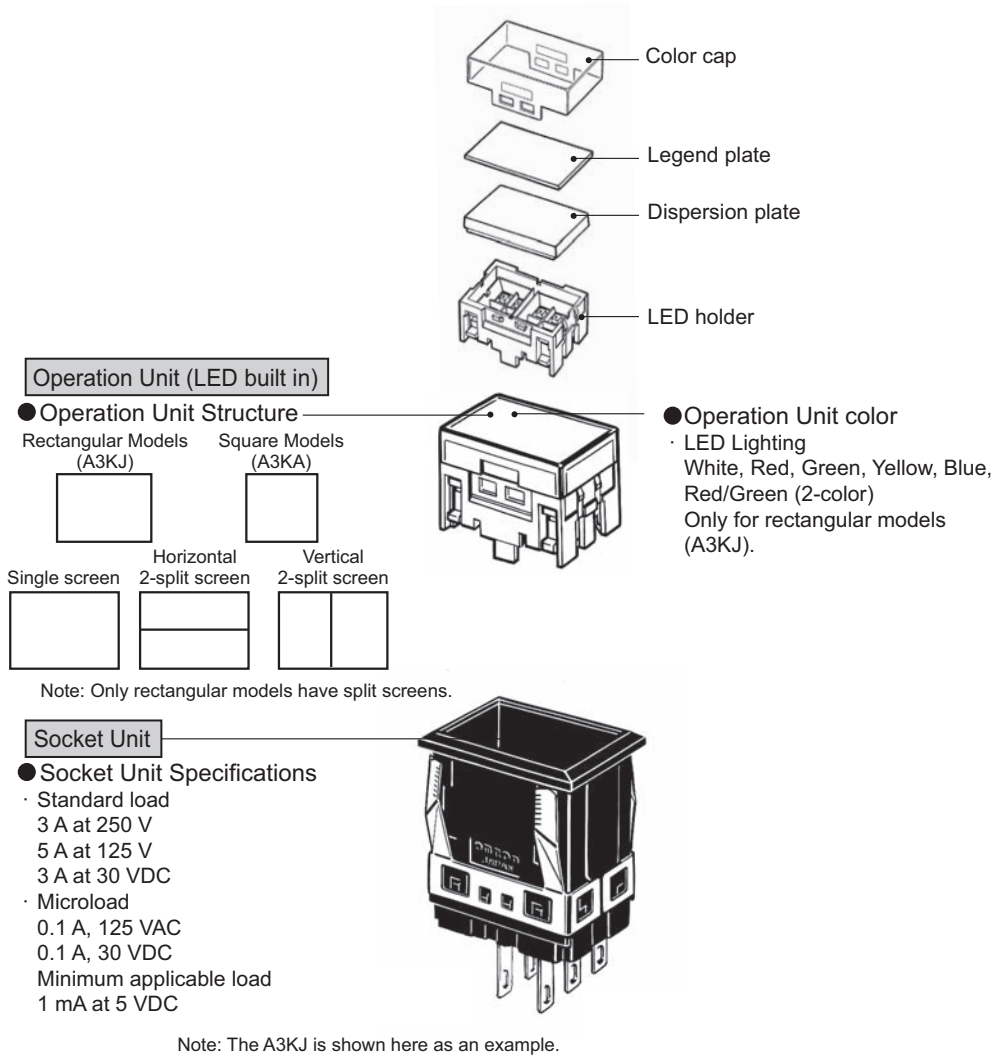

## Dimensions

The Dimension shows 2-switch outputs.

(Unit: mm)

### Rectangular Models (A3KJ)

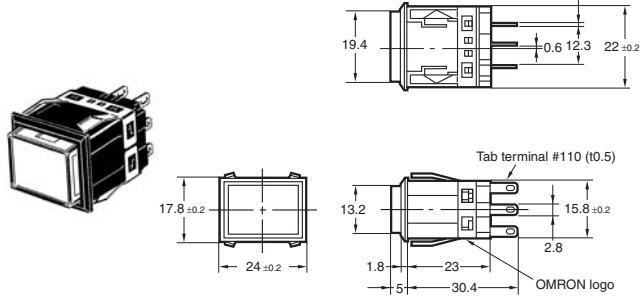

### Square Models (A3KA)

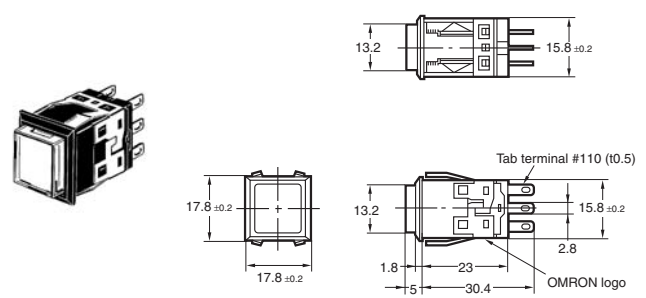

Note: Unless specified, a tolerance of  $\pm 0.4$  mm applies for all dimensions. Use a mounting panel thickness of 1 to 4 mm.

## Terminal Arrangement

Bottom View (All OMRON logos face down.)

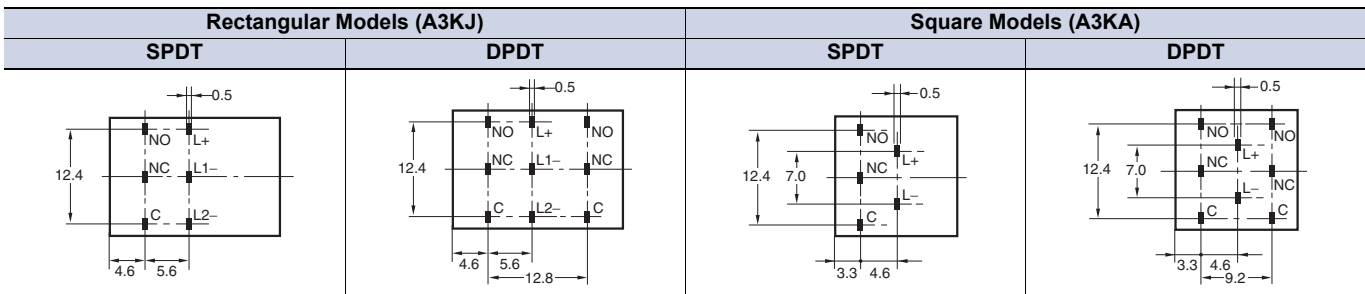

## Terminal Connections

### LED-lighted Models

(The terminal arrangement diagram shows a 1-switch output. Connections to terminals from the lighting block are the same for 2 outputs.)

| Rated voltage |                                | 5 VDC                |  | 12 VDC               |  | 24 VDC               |  |
|---------------|--------------------------------|----------------------|--|----------------------|--|----------------------|--|
| Model         | Screen pattern                 | Terminal arrangement |  | Terminal arrangement |  | Terminal arrangement |  |
| A3KJ          | Single screen                  |                      |  |                      |  |                      |  |
|               | Horizontal 2-split screen      |                      |  |                      |  |                      |  |
|               | Vertical 2-split screen        |                      |  |                      |  |                      |  |
|               | Two-color lighting (red/green) |                      |  |                      |  |                      |  |
| A3KA          | Single screen                  |                      |  |                      |  |                      |  |

Dimensions

Panel Cutouts (If a Switch Guard or Seal Cover is to be used, refer to the panel cutout diagrams on the following page.)

Rectangular Models (A3KJ)

Note: Use a mounting panel thickness of 1 to 4 mm.

| Classification       | Mounting design                     | Panel cutout   | Remarks  |
|----------------------|-------------------------------------|--|--|
| Flange mount models  | Individual mounting, horizontal<br> |  |  |
|                      | Multiple mounting, horizontal<br>   |  | Panel cutout spacing between rows of Units:<br>                |
|                      | Individual mounting, vertical<br>   | Mount to Long Mounting Plate (A3KJ-3002) before use.<br> |  |
|                      | Multiple mounting, vertical<br>     | Mount to Long Mounting Plate (A3KJ-3002) before use.<br> |  |
| Barrier mount models | Individual mounting, horizontal<br> |  |  |
|                      | Multiple mounting, horizontal<br>   |  | Panel cutout spacing between rows of Units:<br>                |
|                      | Individual mounting, vertical<br>   | Mount to Long Mounting Plate (A3KJ-3002) before use.<br> |  |
|                      | Multiple mounting, vertical<br>     | Mount to Long Mounting Plate (A3KJ-3002) before use.<br> | (Dotted line indicates the position of each mounting Barrier.) |

Square Models (A3KA)

Note: Use a mounting panel thickness of 1 to 4 mm.

| Classification       | Mounting design         | Panel cutout | Remarks  |
|----------------------|-------------------------|--------------|--|
| Flange mount models  | Individual mounting<br> |              | Panel cutout spacing between rows of Units:<br>                |
|                      | Multiple mounting<br>   |              |  |
| Barrier mount models | Individual mounting<br> |              | Panel cutout spacing between rows of Units:<br>                |
|                      | Multiple mounting<br>   |              | (Dotted line indicates the position of each mounting Barrier.) |

## Dimensions

### Accessories Dimensions When Mounted

#### Legend Plate

**Rectangular Models**  
A3SJ-4203, A3SJ-4204

**Square Models**  
A3SA-4203, A3SA-4204

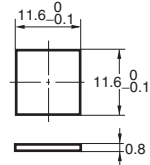
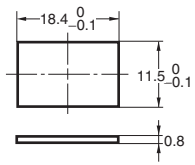

#### Extractor A3PJ-5080

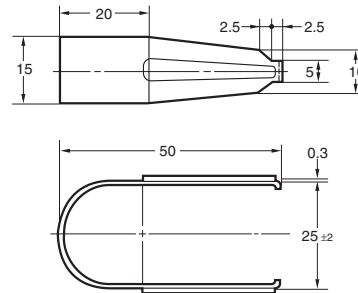

Note: The material is stainless steel.

### Switch Guard Dimensions When Mounted

**Rectangular Models**  
A3SJ-5050

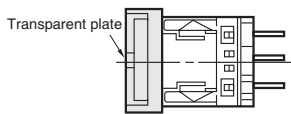

**Square Models**  
A3SA-5050

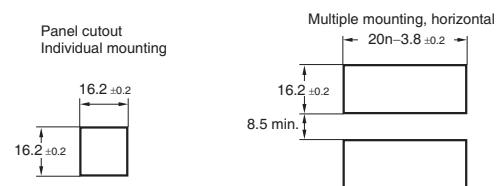
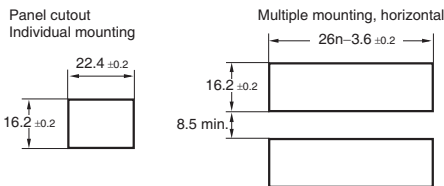
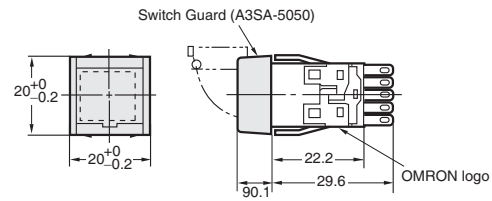
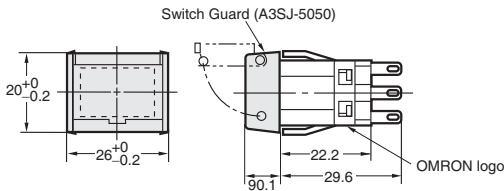
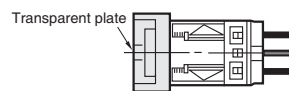

### Seal Cover Dimensions When Mounted

**Rectangular Models**  
A3SJ-5060

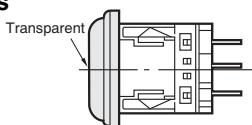

**Square Models**  
A3SA-5060

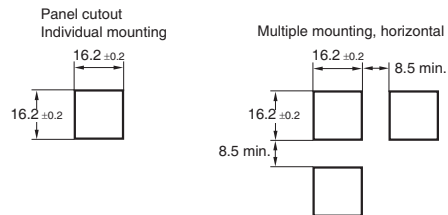
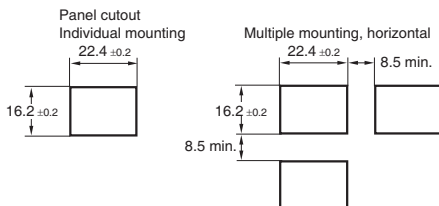
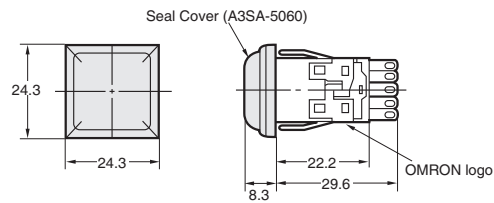
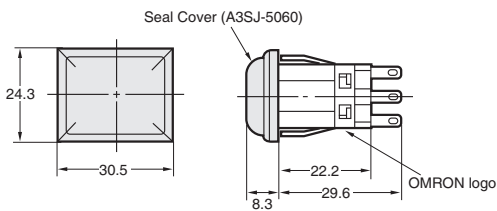
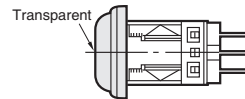

Note: 1. Use a mounting panel thickness of  $t = 1$  to 3.3 mm.  
2. Unless specified, a tolerance of  $\pm 0.4$  mm applies for all dimensions.

## Safety Precautions

Refer to *Safety Precautions for All Pushbutton Switches/Indicators*.

### Precautions for Correct Use

#### Mounting

- Always make sure that the power is turned OFF before mounting, removing, or wiring the Switch, or performing maintenance. Electric shock or fire may occur.

#### Wiring

- For wiring, use a wire size that is appropriate for the applied voltage and the supplied current.  
Be sure to perform soldering according to the following conditions. Using the Switch with incomplete soldering may result in errors and heat, which may cause fire.
  - Manual soldering: Use a soldering iron with a tip temperature of 350°C maximum and complete soldering within 3 seconds.
  - Dip soldering: Solder at 350°C for 3 s or less.  
Wait for one minute after soldering before exerting any external force on the solder.
- Use non-corrosive liquid rosin as the flux.
- Make sure that the insulating sheath of the wires does not come in contact with the Unit. If wiring is performed with the insulating sheath of the wires in contact with the Unit, use wire with a minimum heat resistance of 100°C.
- After wiring the Switch, make sure that there is a suitable isolation distance.

#### Operating Environment

- Do not use in locations that are subject to dust, oil, or metal filings, because these may penetrate the interior of the Switch and cause malfunction.

#### Using Microloads

- Using a standard load switch when a microload circuit is opened or closed may cause wear on the contacts. Use the switch within the operating range. (Refer to the diagram below.) Even when using microload models within the operating range shown below, if inrush current occurs when the contacts are opened or closed, it may cause the contact surface to become rough, and so decrease life expectancy. Therefore, insert a contact protection circuit where necessary. The minimum applicable load is the N-level reference value. This value indicates the malfunction reference level for the reliability level of 60% ( $\lambda_{60}$ ) (conforming to JIS C5003).  
The equation  $\lambda_{60} = 0.5 \times 10^{-6}/\text{time}$  indicates that the estimated malfunction rate is less than 1/2,000,000 with a reliability level of 60%.

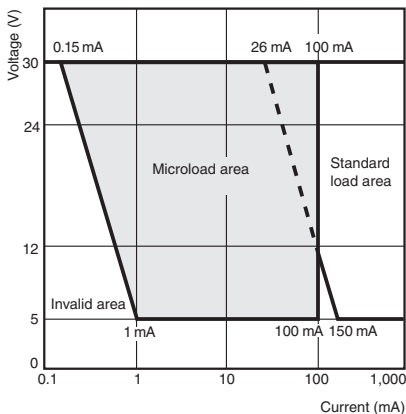

#### Character Film

- If the character film is to be specially prepared, use heat-resistant film with a maximum thickness of 0.2 mm.



#### LEDs

- A current-limiting resistor for the LED is built in, so no external resistor is required.
- Do not apply more than the rated current to the LED. Doing so may damage the LED.

#### Two-color Lighting

- With two-color lighting, changing the terminal connections enables two-color (red/green) full-surface colored illumination. (Only for models with the Display color symbol K.)
- To light two colors at the same time, connect an external resistors as described in the following table.

| Connection Voltage | Green: L1      | Red: L2        |
|--------------------|----------------|----------------|
| 5 V                | 270 Ω (1/2 W)  | 270 Ω (1/2 W)  |
| 12 V               | 900 Ω (1/2 W)  | 900 Ω (1/2 W)  |
| 24 V               | 1.8 KΩ (1/2 W) | 1.8 KΩ (1/2 W) |

## Application

### Removing the Operation Unit

- Grasp the groove on the cap surface, and pull it firmly toward you to remove the Unit.
- An Extractor (A3PJ-5080) is available to conveniently remove the Display.

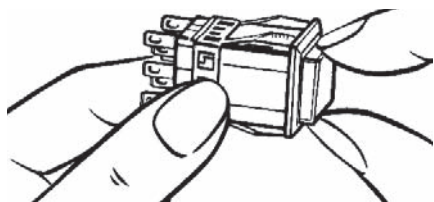

### Inserting the Operation Unit into the Socket Unit

- Insert the Operation Unit in the proper direction. Insert the Operation Unit so that the "+" indication on the back (PCB) is lined up with the "O+" indication inside the Socket Unit.

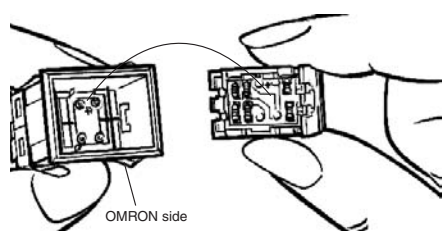

### LED Rating

- The LED voltage rating is indicated on the side of the Operation Unit. Use within a range of  $\pm 5\%$ .

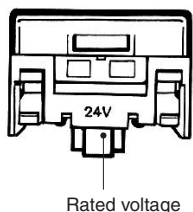

### Mounting to the Switch Panel

- Mount the Socket Unit to the panel by inserting it from the front of the panel.
- Mount the Socket Unit so that the OMRON logo is at the bottom.

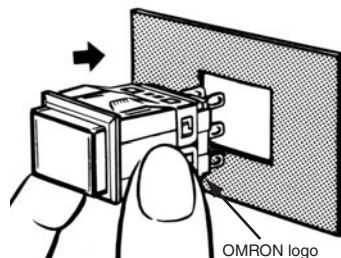

### Barrier Mounting

- Place the Edge Barriers on the side of the Socket Unit, and then insert the Socket Unit into the panel.
- Insert the Intermediate Barrier between the Switches after inserting the Socket Units into the panel.

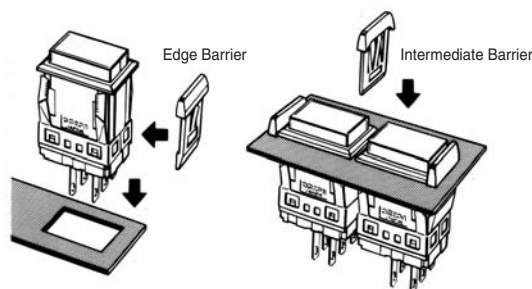

### Inscribing Legend Plate Characters

#### Inscribing

- Inscription depth: 0.5 mm max.
- The legend plate is made of polycarbonate, so apply an alcohol-based paint coating, such as melamine, phthalate, or acrylic resin paint when marking the legend.



### Assembling the Legend Plate (Plunger)

#### A3KA/M2KA

1. Assemble the dispersion plate to the plunger, and then assemble the legend plate on top.

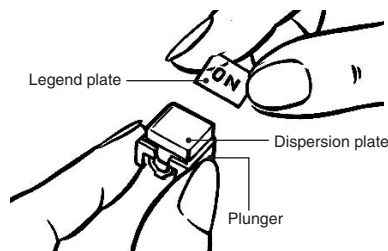

2. Assemble the color cap.

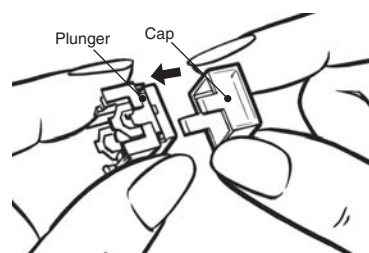



## Terms and Conditions Agreement

### Read and understand this catalog.

Please read and understand this catalog before purchasing the products. Please consult your OMRON representative if you have any questions or comments.

### Warranties.

(a) Exclusive Warranty. Omron's exclusive warranty is that the Products will be free from defects in materials and workmanship for a period of twelve months from the date of sale by Omron (or such other period expressed in writing by Omron). Omron disclaims all other warranties, express or implied.

(b) Limitations. OMRON MAKES NO WARRANTY OR REPRESENTATION, EXPRESS OR IMPLIED, ABOUT NON-INFRINGEMENT, MERCHANTABILITY OR FITNESS FOR A PARTICULAR PURPOSE OF THE PRODUCTS. BUYER ACKNOWLEDGES THAT IT ALONE HAS DETERMINED THAT THE PRODUCTS WILL SUITABLY MEET THE REQUIREMENTS OF THEIR INTENDED USE.

Omron further disclaims all warranties and responsibility of any type for claims or expenses based on infringement by the Products or otherwise of any intellectual property right. (c) Buyer Remedy. Omron's sole obligation hereunder shall be, at Omron's election, to (i) replace (in the form originally shipped with Buyer responsible for labor charges for removal or replacement thereof) the non-complying Product, (ii) repair the non-complying Product, or (iii) repay or credit Buyer an amount equal to the purchase price of the non-complying Product; provided that in no event shall Omron be responsible for warranty, repair, indemnity or any other claims or expenses regarding the Products unless Omron's analysis confirms that the Products were properly handled, stored, installed and maintained and not subject to contamination, abuse, misuse or inappropriate modification. Return of any Products by Buyer must be approved in writing by Omron before shipment. Omron Companies shall not be liable for the suitability or unsuitability or the results from the use of Products in combination with any electrical or electronic components, circuits, system assemblies or any other materials or substances or environments. Any advice, recommendations or information given orally or in writing, are not to be construed as an amendment or addition to the above warranty.

See <http://www.omron.com/global/> or contact your Omron representative for published information.

### Limitation on Liability: Etc.

OMRON COMPANIES SHALL NOT BE LIABLE FOR SPECIAL, INDIRECT, INCIDENTAL, OR CONSEQUENTIAL DAMAGES, LOSS OF PROFITS OR PRODUCTION OR COMMERCIAL LOSS IN ANY WAY CONNECTED WITH THE PRODUCTS, WHETHER SUCH CLAIM IS BASED IN CONTRACT, WARRANTY, NEGLIGENCE OR STRICT LIABILITY.

Further, in no event shall liability of Omron Companies exceed the individual price of the Product on which liability is asserted.

### Suitability of Use.

Omron Companies shall not be responsible for conformity with any standards, codes or regulations which apply to the combination of the Product in the Buyer's application or use of the Product. At Buyer's request, Omron will provide applicable third party certification documents identifying ratings and limitations of use which apply to the Product. This information by itself is not sufficient for a complete determination of the suitability of the Product in combination with the end product, machine, system, or other application or use. Buyer shall be solely responsible for determining appropriateness of the particular Product with respect to Buyer's application, product or system. Buyer shall take application responsibility in all cases.

NEVER USE THE PRODUCT FOR AN APPLICATION INVOLVING SERIOUS RISK TO LIFE OR PROPERTY OR IN LARGE QUANTITIES WITHOUT ENSURING THAT THE SYSTEM AS A WHOLE HAS BEEN DESIGNED TO ADDRESS THE RISKS, AND THAT THE OMRON PRODUCT(S) IS PROPERLY RATED AND INSTALLED FOR THE INTENDED USE WITHIN THE OVERALL EQUIPMENT OR SYSTEM.

### Programmable Products.

Omron Companies shall not be responsible for the user's programming of a programmable Product, or any consequence thereof.

### Performance Data.

Data presented in Omron Company websites, catalogs and other materials is provided as a guide for the user in determining suitability and does not constitute a warranty. It may represent the result of Omron's test conditions, and the user must correlate it to actual application requirements. Actual performance is subject to the Omron's Warranty and Limitations of Liability.

### Change in Specifications.

Product specifications and accessories may be changed at any time based on improvements and other reasons. It is our practice to change part numbers when published ratings or features are changed, or when significant construction changes are made. However, some specifications of the Product may be changed without any notice. When in doubt, special part numbers may be assigned to fix or establish key specifications for your application. Please consult with your Omron's representative at any time to confirm actual specifications of purchased Product.

### Errors and Omissions.

Information presented by Omron Companies has been checked and is believed to be accurate; however, no responsibility is assumed for clerical, typographical or proofreading errors or omissions.